



Operator's Manual
CLK-Class



2 0 9 5 8 4 9 8 9 6

Order No. 6515 1326 13 Part No. 209 584 98 96 USA Edition A 2008

CLK-Class



Mercedes-Benz

CLK 350

CLK 550

CLK 63 AMG

Our company and staff congratulate you on the purchase of your new Mercedes-Benz.

Your selection of our product is a demonstration of your trust in our company name. Furthermore, it exemplifies your desire to own an automobile that will be as easy as possible to operate and provide years of service.

Your Mercedes-Benz represents the efforts of many skilled engineers and craftsmen. To help assure your driving pleasure, and also the safety of you and your passengers, we ask you to make a small investment of time:

- Please read this manual carefully, then return it to your vehicle where it will be handy for your reference.
- Please follow the recommendations contained in this manual. They are designed to acquaint you with the operation of your Mercedes-Benz.
- Please pay attention to the warnings and cautions contained in this manual. They are designed to help improve the safety of the vehicle operator and occupants.

We extend our best wishes for many miles of safe, pleasurable driving.

Mercedes-Benz USA, LLC
A DaimlerChrysler Company

Introduction	9
Product information.....	9
Operator's Manual.....	10
Service and warranty information ..	10
Important notice for California retail buyers and lessees of Mercedes-Benz automobiles	11
Maintenance	12
Roadside Assistance	12
Change of address or ownership....	12
Operating your vehicle outside the USA or Canada	13
Where to find it.....	14
Symbols.....	15
Operating safety	16
Proper use of the vehicle	16
Problems with your vehicle.....	17
Reporting safety defects.....	18
Reporting safety defects	18
Vehicle data recording.....	19
Information regarding electronic recording devices.....	19

At a glance	21
Exterior view (Coupe)	22
Exterior view (Cabriolet)	24
Cockpit.....	26
Instrument cluster	28
Multifunction steering wheel	30
Center console	31
Upper part	31
Lower part	32
Overhead control panel	33
Door control panel.....	34

Getting started	35
Unlocking	36
Unlocking with the SmartKey	36
Unlocking with KEYLESS-GO*	37
Starter switch positions.....	38
Adjusting	41
Seats	41
Steering wheel.....	44
Mirrors.....	47
Driving.....	48
Fastening the seat belts	48
Starting the engine	51
Parking brake	53
Driving	54
Switching on headlamps.....	55
Turn signals	56
Windshield wipers.....	56
Problems while driving.....	58
Parking and locking.....	59
Parking brake	59
Switching off headlamps.....	60
Turning off the engine.....	60
Releasing seat belts.....	61
Locking	61

Safety and Security	63	Controls in detail	99	Seat ventilation*	126
Occupant safety	64	Locking and unlocking	100	Memory function	127
Air bags	65	SmartKey	100	Storing positions into memory	128
Occupant Classification System	72	SmartKey with KEYLESS-GO*	103	Recalling positions from memory	128
Seat belts	77	Checking the batteries in the		Lighting	129
Active head restraints	81	SmartKey or SmartKey with		Exterior lamp switch	129
Roll bars (only CLK cabriolet)	82	KEYLESS-GO*	108	Combination switch	133
Children in the vehicle	83	Loss of the SmartKey or		Corner-illuminating	
Blocking of rear		SmartKey with KEYLESS-GO*	109	front fog lamps* (With Bi-Xenon*	
side window operation	88	Opening the doors from the inside	109	headlamps only)	133
Panic alarm	89	Opening the trunk	110	Hazard warning flasher	135
Activating	89	Closing the trunk	112	Interior lighting	136
Deactivating	89	Trunk emergency release	117	Door entry lamps	137
Driving safety systems	90	Valet locking	118	Trunk lamp	137
ABS	90	Automatic central locking	118	Instrument cluster	138
BAS	92	Locking and unlocking		Adjusting instrument cluster	
ESP®	92	from the inside	119	illumination	138
Anti-theft systems	97	Seats	120	Coolant temperature indicator	139
Immobilizer	97	Front seat active head restraints .	120	Resetting trip odometer	139
Anti-theft alarm system	97	Rear seat head restraints		Tachometer	140
		(CLK coupe)	120	Clock	140
		Rear seat head restraints		Outside temperature indicator	140
		(CLK cabriolet)	123	Control system	141
		Multicontour seat*	124	Multifunction display	141
		Seat heating*	125	Multifunction steering wheel	142
				Menus	144

Standard display menu	147	Good visibility	185	Setting the temperature	204
AMG menu	148	Headlamp cleaning system*	185	Adjusting air distribution	205
AUDIO menu	151	Rear view mirrors.....	185	Adjusting air volume	206
Navi* menu	153	Sun visors	187	Front defroster	206
Vehicle status		Rear window sunshade*		Maximum cooling MAXCOOL.....	207
message memory menu	154	(CLK coupe: Canada only).....	188	Air recirculation mode	207
Settings menu.....	155	Rear window defroster.....	189	Charcoal filter	209
Trip computer menu.....	167	Climate control.....	190	Air conditioning	210
TEL* menu	169	Deactivating the climate control		Residual heat and ventilation*	
Automatic transmission.....	172	system	193	(Canada only).....	211
Gear selector lever.....	172	Operating the climate control		Rear passenger compartment	
Shifting procedure	173	system in automatic mode.....	193	adjustable air vents	212
Gear selector lever positions	174	Setting the temperature.....	194	Audio system.....	213
Driving tips.....	176	Adjusting air distribution.....	194	Audio and telephone*, operation..	213
Gear ranges	177	Adjusting air volume	195	Operating safety	213
Automatic shift program	178	Front defroster.....	195	Sound system*	213
Gear selector lever		Air recirculation mode	196	Operating and display elements ...	214
one-touch gearshifting	179	Air conditioning.....	198	Button and soft key operation	216
Steering wheel gearshift		Rear passenger compartment		Operation.....	216
control one-touch gearshifting* ...	180	adjustable air vents.....	199	Radio operation	221
Manual shift program		Automatic climate control	200	Satellite radio*	225
CLK 63 AMG	182	Deactivating the automatic		CD mode.....	229
Emergency operation		climate control system	203	GSM network phones	236
(Limp-Home Mode)	184	Operating the automatic climate		TDMA or CDMA network phones ..	242
		control system		Emergency calls “911”	248
		in automatic mode.....	203		

Contents

Power windows.....	250	Loading.....	275	Operation	307
Opening and closing the windows	250	Roof rack (CLK coupe only).....	275	The first 1000 miles (1500 km)	308
Synchronizing power windows	252	Ski bag* (Canada only)	276	Driving instructions	309
Summer opening feature.....	253	Split rear bench seat		Drive sensibly – save fuel.....	309
Convenience closing feature	254	(CLK coupe only).....	281	Drinking and driving	309
Opening and closing all side		Loading instructions.....	283	Pedals	309
windows with the soft top switch		Cargo tie-down rings		Power assistance	310
(CLK cabriolet)	255	(CLK coupe only).....	284	Brakes.....	310
Power tilt/sliding sunroof* (Coupe)...	256	Useful features	285	Driving off	312
Opening and closing		Storage compartments	285	Parking.....	312
the power tilt/sliding sunroof	256	Center armrest.....	287	Tires.....	313
Synchronizing		Armrest in the		Hydroplaning.....	314
the power tilt/sliding sunroof	258	rear passenger compartment.....	287	Tire traction	314
Soft top (Cabriolet)	259	Cup holders.....	288	Tire speed rating	315
Opening and closing the soft top .	259	Ashtrays.....	289	Winter driving instructions.....	316
Opening and closing the soft top		Cigarette lighter	290	Standing water.....	317
with the SmartKey.....	263	Power outlet in the		Passenger compartment.....	317
Luggage cover.....	264	rear passenger compartment.....	291	Driving abroad	317
Wind screen	265	Floor mats*	291	Control and operation	
Driving systems	267	Telephone*	292	of radio transmitters	317
Cruise control.....	267	Tele Aid	295	Catalytic converter.....	318
Parktronic system		Garage door opener*	301	Emission control	318
(Parking assist)*,				Coolant temperature.....	319
CLK 63 AMG (USA),					
Canada all models.....	271				

At the gas station	320	Maximum tire inflation pressure ...	355	Practical hints	377
Refueling.....	320	Uniform Tire Quality Grading		What to do if ...?	378
Check regularly		Standards (U.S. vehicles).....	356	Lamps in instrument cluster	378
and before a long trip.....	322	Tire ply material	357	Lamp in center console	390
Engine compartment	323	Tire and loading terminology.....	358	Vehicle status messages	
Hood	323	Rotating tires	361	in the multifunction display	392
Engine oil	325	Winter driving	362	Where will I find...?	421
Transmission fluid level.....	327	Winter tires	362	First aid kit.....	421
Coolant	328	Block heater (Canada only).....	363	Storage compartment	
Battery	329	Snow chains.....	363	underneath the trunk floor.....	421
Windshield washer system and		Maintenance.....	364	TIREFIT (CLK 63 AMG only).....	422
headlamp cleaning system*	330	Maintenance service		Vehicle tool kit.....	422
Tires and wheels.....	331	indicator message.....	364	Minispare wheel.....	425
Important guidelines	331	Clearing the maintenance		Spare wheel bolts	426
Tire care and maintenance.....	332	service indicator message	365	Unlocking/locking in an emergency ..	427
Direction of rotation.....	334	Maintenance		Unlocking the vehicle	427
Loading the vehicle	334	service term exceeded.....	365	Locking the vehicle.....	428
Recommended		Calling up the maintenance		Manually unlocking	
tire inflation pressure.....	339	service indicator display	366	the gear selector lever.....	429
Checking tire inflation pressure ...	341	Resetting the maintenance		Opening/closing	
MOExtended system*	348	service indicator	366	in an emergency (Cabriolet)	430
Tire labeling.....	348	Vehicle care.....	367	Operating roll bars manually.....	430
Load identification	352	Cleaning and care of vehicle	367	Soft top emergency operation	432
DOT,					
Tire Identification Number (TIN)...	353				
Maximum tire load	354				

Contents

Resetting activated head restraints ...	440	Towing the vehicle	469	Electrical system	487
Resetting		Towing the vehicle	469	Main dimensions and weights	488
activated head restraints.....	440	Installing towing eye bolt	470	Main dimensions.....	488
Replacing SmartKey batteries.....	441	Fuses	472	Weights.....	488
SmartKey / SmartKey		Fuse box		Fuels, coolants, lubricants, etc.	489
with KEYLESS-GO*	442	in passenger compartment	472	Capacities	489
Replacing bulbs	443	Fuse box		Engine oils	491
Bulbs	444	in engine compartment	473	Engine oil additives	491
Replacing bulbs for front lamps....	446	Fuse box		Air conditioning refrigerant	491
Replacing bulbs for rear lamps....	448	in trunk	474	Brake fluid.....	491
Replacing wiper blades	450			Premium unleaded gasoline	492
Removing and installing				Fuel requirements.....	492
wiper blades.....	450	Technical data	475	Gasoline additives.....	493
Flat tire	452	Parts service	476	Coolants	494
Preparing the vehicle.....	452	Warranty coverage.....	477	Windshield washer system	
Sealing tires with TIREFIT		Loss of Service and Warranty		and headlamp cleaning system* ..	496
(CLK 63 AMG only).....	452	Information Booklet	477		
Mounting the Minispare wheel	458	Identification labels	478		
MOExtended system*	463	Layout of poly-V-belt drive	480		
Battery	464	CLK 350 / CLK 550	480	Index	497
Disconnecting the battery	465	CLK 63 AMG	480		
Removing the battery	465	Engine.....	481		
Charging and		Rims and tires.....	482		
reinstalling the battery	466	Same size tires.....	483		
Reconnecting the battery	466	Mixed size tires	484		
Jump starting	467	Minispare wheel.....	486		

▼ Product information

Please observe the following in your own best interest:

We recommend using Genuine Mercedes-Benz Parts as well as conversion parts and accessories explicitly approved by us for your vehicle model.

We have tested these parts to determine their reliability, safety and special suitability for Mercedes-Benz vehicles.

We are unable to make an assessment for other products and therefore cannot be held responsible for them, even if in individual cases an official approval or authorization by governmental or other agencies should exist. Use of such parts and accessories could adversely affect the safety, performance or reliability of your vehicle. Please do not use them.

Genuine Mercedes-Benz Parts as well as conversion parts and accessories approved by us are available at any authorized Mercedes-Benz Center where you will receive comprehensive information, also on permissible technical modifications, and where proper installation will be performed.

This Operator's Manual contains a great deal of useful information. We urge you to read it carefully and familiarize yourself with the vehicle before driving.

For your own safety and longer service life of the vehicle, we urge you to follow the instructions and warnings contained in this manual. Ignoring them could result in damage to the vehicle or personal injury to you or others. Vehicle damage caused by failure to follow instructions is not covered by the Mercedes-Benz Limited Warranty.

Your vehicle may have some or all of the equipment described in this manual. Therefore, you may find explanations for optional equipment not installed in your vehicle. If you have any questions about the operation of any equipment, any authorized Mercedes-Benz Center will be glad to demonstrate the proper procedures.

We continuously strive to improve our product, and ask for your understanding that we reserve the right to make changes in design and equipment. Therefore, information, illustrations and descriptions in this Operator's Manual might differ from your vehicle.

Optional equipment is also described in this manual, including operating instructions wherever necessary. Since they are special-order items, the descriptions and illustrations herein may vary slightly from the actual equipment of your vehicle.

If there are any equipment details that are not shown or described in this Operator's Manual, any authorized Mercedes-Benz Center will be glad to inform you of correct care and operating procedures. The Operator's Manual and Maintenance Booklet are important documents and should be kept with the vehicle.

Service and warranty information

The Service and Warranty Information Booklet contains detailed information about the warranties covering your Mercedes-Benz, including:

- New Car Limited Warranty
- Emission System Warranty
- Emission Performance Warranty
- California, Maine, Massachusetts, and Vermont Emission Control System Warranty (California, Maine, Massachusetts, and Vermont only)
- State Warranty Enforcement Laws (Lemon Laws)

Important notice for California retail buyers and lessees of Mercedes-Benz automobiles

Under California law you may be entitled to a replacement of your vehicle or a refund of the purchase price or lease price, if Mercedes-Benz USA, LLC and/or its authorized repair or service facilities fail to fix one or more substantial defects or malfunctions in the vehicle that are covered by its express warranty after a reasonable number of repair attempts. During the period of 18 months from original delivery of the vehicle or the accumulation of 18 000 miles (approximately 29 000 km) on the odometer of the vehicle, whichever occurs first, a reasonable number of repair attempts is presumed for a retail buyer or lessee if one or more of the following occurs:

- (1) the same substantial defect or malfunction results in a condition that is likely to cause death or serious bodily injury if the vehicle is driven, that defect or malfunction has been subject to repair two or more times, and you have directly notified Mercedes-Benz USA, LLC in writing of the need for its repair,
- (2) the same substantial defect or malfunction of a less serious nature than category (1) has been subject to repair four or more times and you have directly notified us in writing of the need for its repair, or
- (3) the vehicle is out of service by reason of repair of the same or different substantial defects or malfunctions for a cumulative total of more than 30 calendar days.

Written notification should not be sent to a dealer, it should be addressed to Mercedes-Benz USA, LLC Customer Assistance Center One Mercedes Drive Montvale, NJ 07645-0350

Maintenance

The Maintenance Booklet describes all the necessary maintenance work which should be performed at regular intervals.

Always have the Maintenance Booklet with you when you take the vehicle to an authorized Mercedes-Benz Center for service. The service advisor will record each service in the booklet for you.

Roadside Assistance

The Mercedes-Benz Roadside Assistance Program provides factory trained technical help in the event of a breakdown. Calls to the toll-free Roadside Assistance number

1-800-FOR-MERCEdes (in the USA)
1-800-387-0100 (in Canada)

will be answered by Mercedes-Benz Customer Assistance Representatives 24 hours a day, 365 days a year.

For additional information refer to the Mercedes-Benz Roadside Assistance Program Brochure in your vehicle literature portfolio.

Change of address or ownership

If you change your address, be sure to send in the "Change of Address Notice" found in the Service and Warranty Information Booklet, or simply call the Mercedes-Benz Customer Assistance Center (in the USA) at 1-800-FOR-MERCEdes, or Customer Service (in Canada) at 1-800-387-0100. It is in your own interest that we can contact you should the need arise.

If you sell your Mercedes, please leave all literature with the vehicle to make it available to the next operator.

If you bought this vehicle used, be sure to send in the "Notice of Purchase of Used Car" found in the Service and Warranty Information Booklet, or call the Mercedes-Benz Customer Assistance Center (in the USA) at 1-800-FOR-MERCEdes, or Customer Service (in Canada) at 1-800-387-0100.

Operating your vehicle outside the USA or Canada

If you plan to operate your vehicle in foreign countries, please be aware that:

- service facilities or replacement parts may not be readily available,
- unleaded gasoline for vehicles with catalytic converters may not be available; the use of leaded fuels will damage the catalysis,
- gasoline may have a considerably lower octane rating, and improper fuel can cause engine damage.

Certain Mercedes-Benz models are available for delivery in Europe under our European Delivery Program. For details, consult an authorized Mercedes-Benz Center or write to:

In the USA:

Mercedes-Benz USA, LLC
European Delivery Department
One Mercedes Drive
Montvale, NJ 07645-0350

In Canada:

Mercedes-Benz Canada Inc.
European Delivery Department
98 Vanderhoof Avenue
Toronto, Ontario M4G 4C9

Where to find it

This Operator's Manual is designed to provide comprehensive support information for you, the vehicle operator. Each section has its own reference color.

At a glance

Here you will find an overview of your vehicle's interior and exterior main features.

Getting started

Here you will find all the information you need for your first drive. You should read this section first if this is your first Mercedes-Benz vehicle or if you are renting or borrowing this vehicle.

Safety and Security

Here you will find descriptions of the safety and security features of your vehicle.

Controls in detail

Here you will find detailed information about the equipment installed in your vehicle. This section expands on the "Getting started" section and also describes technical innovations. If you are already familiar with the basic functions of your vehicle, this section will be of particular interest to you.

Operation

Here you will find all the information you need for the proper operation of your vehicle.

Practical hints

This section provides fast assistance for dealing with problems you may encounter.

Technical data

All important technical data for your vehicle can be found in this section.

Indexes

The table of contents and the index are designed to help you find information quickly and easily.

The following publications are part of your vehicle documentation:

- this Operator's Manual
- the Maintenance Booklet

Separate operating instructions will be provided as required depending on the equipment options installed in your vehicle.

▼ Symbols

Trademarks:

- ESP® is a registered trademark of DaimlerChrysler.
- HomeLink® is a registered trademark of Prince, a Johnson Controls Company.
- SIRIUS and related marks are trademarks of SIRIUS Satellite Radio Inc.

The following symbols are found in this Operator's Manual:

- * Optional equipment is identified with an asterisk. Since standard equipment varies between models, the descriptions and illustrations in this manual may differ slightly from the actual equipment of your vehicle.

Warning!



Warning notices draw your attention to hazards that may endanger your health or life, or the health or life of others.

! *Highlights hazards that may result in damage to your vehicle.*

i *Helpful hints or further information you may find useful.*

- ▶ This symbol points to instructions for you to follow.
- ▶ A number of these symbols appearing in succession indicates a multiple-step procedure.
- ▷ page This symbol tells you where to look for further information on a topic.
- ▷▷ This continuation symbol marks a warning which is continued on the next page.
- ▷▷ This continuation symbol marks a procedure which is continued on the next page.
- > This symbol is used to indicate cross-references to term definitions.
- Display Words appearing in the multi-function display and Audio display are printed in the type shown here.

Warning!



Work improperly carried out on electronic components and associated software could cause them to cease functioning. Because the vehicle's electronic components are interconnected, any modifications made may produce an undesired effect on other systems. Electronic malfunctions could seriously impair the operating safety of your vehicle.

See an authorized Mercedes-Benz Center for repairs or modifications to electronic components.

Other improper work or modifications on the vehicle could also have a negative impact on the operating safety of the vehicle.

Some safety systems only function while the engine is running. You should therefore never turn off the engine while driving.

Warning!



Heavy blows against the vehicle underbody or tires / wheels, for example when running over an obstacle, road debris or a pothole, may cause serious damage to and impair the operating safety of your vehicle. If you feel a sudden significant vibration or ride disturbance, or you suspect that damage to your vehicle has occurred, you should turn on your hazard warning flashers, carefully slow down, and drive with caution to an area which is a safe distance from the road.

Inspect the vehicle underbody and tires / wheels for possible damage. If the vehicle appears unsafe, have it towed to the nearest authorized Mercedes-Benz Center or other qualified maintenance or repair facility for further inspection or repairs.

Proper use of the vehicle

Proper use of the vehicle requires that you are familiar with the following information and rules:

- the safety precautions in this manual
- the “Technical data” section in this manual
- traffic rules and regulations
- motor vehicle laws and safety standards

Warning!



Various warning labels are attached to your vehicle. These warning labels are intended to make you and others aware of various risks. You should not remove any of these warning labels unless explicitly instructed to do so by information on the label itself. Removal of any of these labels may cause you and others to be unaware of certain risks which may result in an accident and/or personal injury.

▼ Problems with your vehicle

If you should experience a problem with your vehicle, particularly one that you believe may affect its safe operation, we urge you to immediately contact an authorized Mercedes-Benz Center to have the problem diagnosed and corrected if required. If the matter is not handled to your satisfaction, please discuss the problem with the Mercedes-Benz Center management, or if necessary contact us at one of the following addresses:

In the USA:

Customer Assistance Center
Mercedes-Benz USA, LLC
One Mercedes Drive
Montvale, NJ 07645-0350

In Canada:

Customer Relations Department
Mercedes-Benz Canada Inc.
98 Vanderhoof Avenue
Toronto, Ontario M4G 4C9

Reporting safety defects

For the USA only:

The following text is published as required of manufacturers under Title 49, Code of U.S. Federal Regulations, Part 575 pursuant to the “National Traffic and Motor Vehicle Safety Act of 1966”.

Reporting safety defects

If you believe that your vehicle has a defect which could cause a crash or could cause injury or death, you should immediately inform the National Highway Traffic Safety Administration (NHTSA) in addition to notifying Mercedes-Benz USA, LLC.

If NHTSA receives similar complaints, it may open an investigation, and if it finds that a safety defect exists in a group of vehicles, it may order a recall and remedy campaign. However, NHTSA cannot become involved in individual problems between you, your dealer, or Mercedes-Benz USA, LLC.

To contact NHTSA, you may call the Vehicle Safety Hotline toll-free at 1-888-327-4236 (TTY: 1-800-426-9153); go to <http://www.safercar.gov>; or write to: Administrator, NHTSA, 400 Seventh Street, SW., Washington, DC 20590. You can also obtain other information about motor vehicle safety from <http://www.safercar.gov>.

▼ Vehicle data recording

Information regarding electronic recording devices

(Including notice pursuant to California Code § 9951)

Please note that your vehicle is equipped with devices that can record vehicle systems data and, if equipped with the Tele Aid system, may transmit some data in certain accidents.

This information helps, for example, to diagnose vehicle systems after a collision and to continuously improve vehicle safety. DaimlerChrysler may access the information and share it with others

- for safety research or vehicle diagnosis purposes
- with the consent of the vehicle owner or lessee
- in response to an official request by law enforcement or other government agency
- for use in dispute resolution involving DaimlerChrysler, its affiliates or sales/service organization and/or
- as otherwise required or permitted by law.

Please check the Tele Aid subscription service agreement for details regarding the information that may be recorded or transmitted via that system.

Exterior view (Coupe)

Exterior view (Cabriolet)

Cockpit

Instrument cluster

Multifunction steering wheel

Center console

Overhead control panel

Door control panel



Exterior view (Coupe)

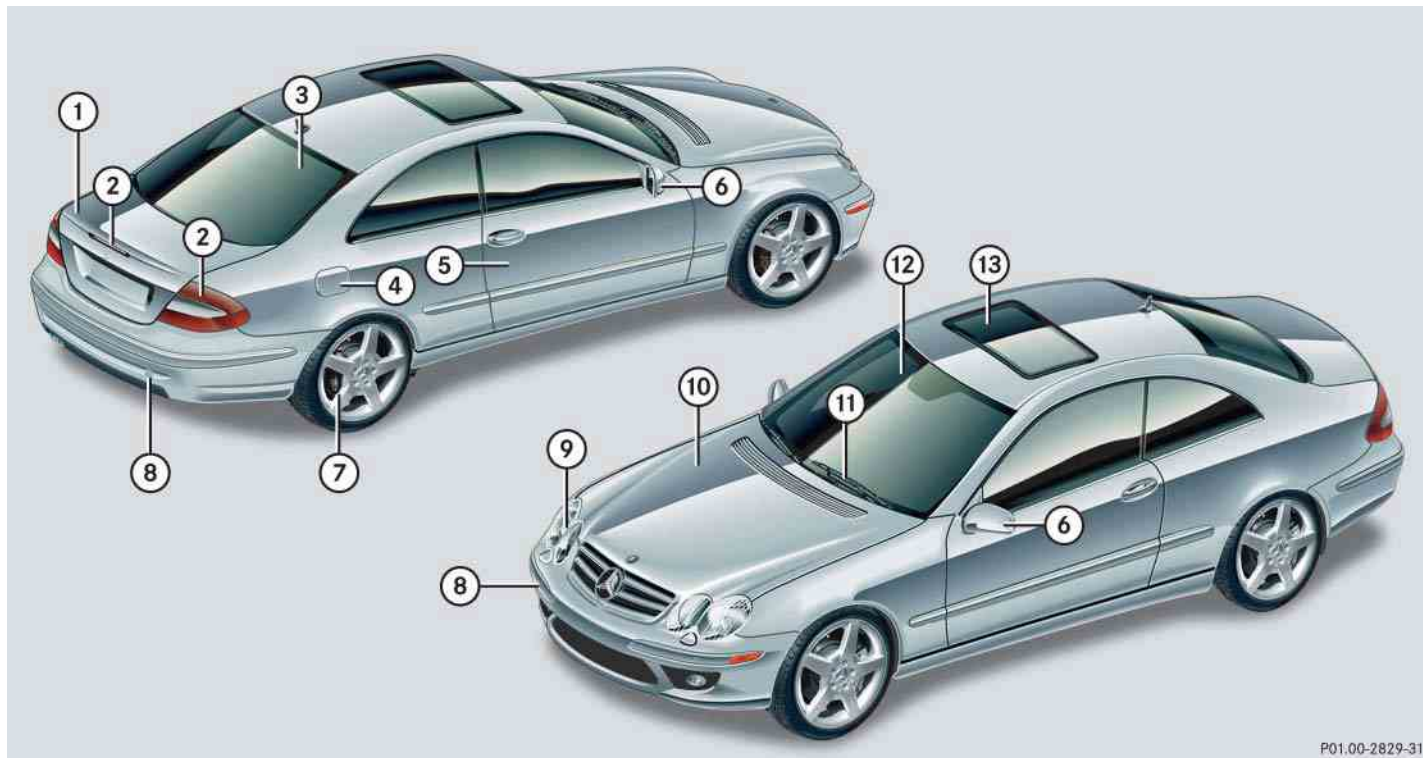

P01.00-2829-31

Item	Page
① Trunk	
Unlocking	36
Opening and closing	110, 112
Minispare wheel	425
Vehicle tool kit	423
② Rear lamps	444
③ Rear window, defrosting	189
④ Fuel filler flap	320
Refueling	320
Gasoline	492
⑤ Doors	
Locking and unlocking	36, 62, 100
Opening	109
Locking/unlocking in an emergency	427

Item	Page
⑥ Exterior rear view mirror	
Adjusting	47
Auto-dimming rear view mirrors	186
⑦ Tires and wheels	331
Checking tire inflation pressure	341
Run Flat Indicator (Canada only)	342
Tire Pressure Monitoring (USA only)	344
General information	331
Vehicle tool kit	422
Minispare wheel	425
Flat tire	452
⑧ Towing	469
Installing towing eye bolt	470
⑨ Front lamps	446

Item	Page
⑩ Hood, opening	323
Engine oil	325
Coolant	328
Battery	329
⑪ Windshield wipers	56
Wiper blades, replacing	450
Wiper blades, cleaning	373
⑫ Windshield	
Front window, defrosting	191, 201
Cleaning with wiper fluid	57
Cleaning	373
⑬ Power tilt/sliding sunroof	
Opening and closing	257
Opening and closing in an emergency	430

Exterior view (Cabriolet)

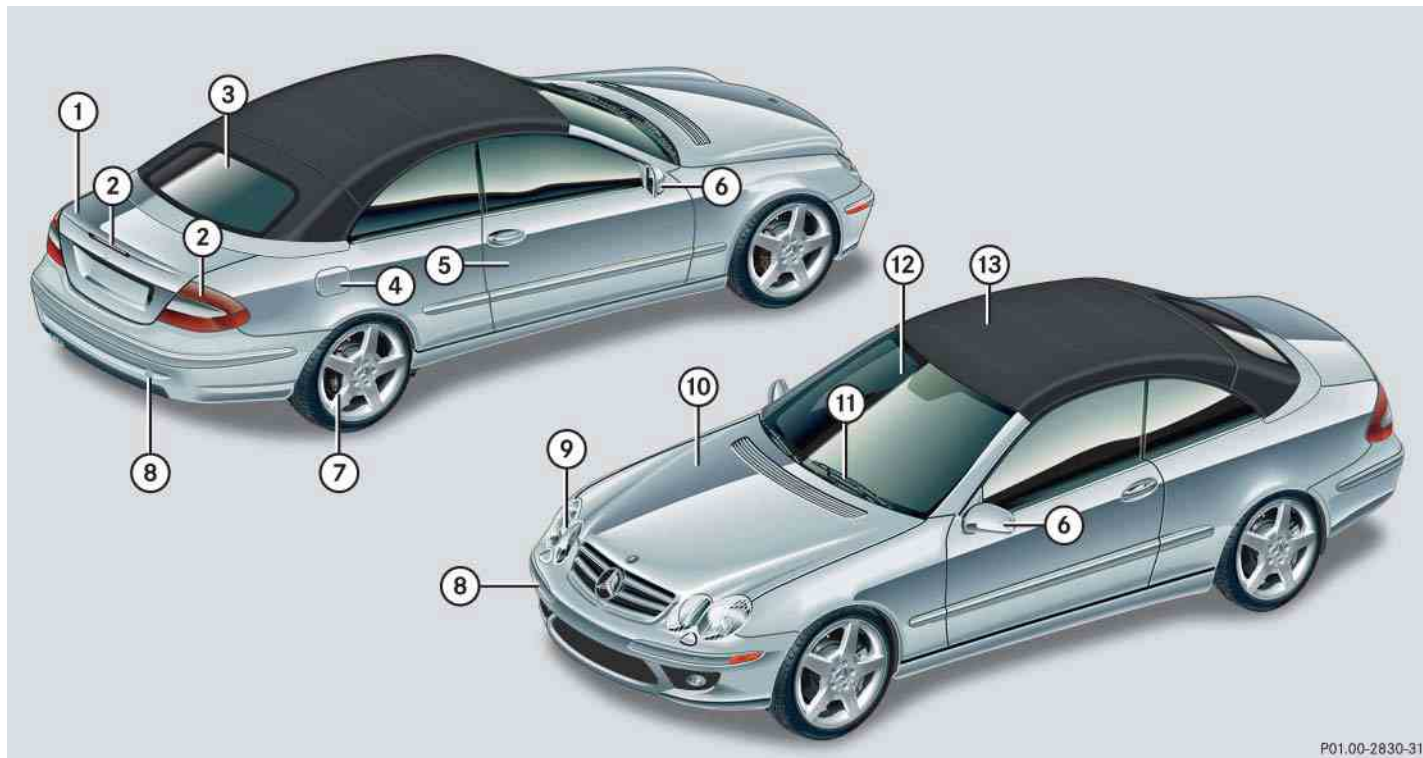

P01.00-2830-31

Exterior view (Cabriolet)

Item	Page
① Trunk	
Unlocking	103
Opening and closing	110, 112
TIREFIT Kit (CLK 63 AMG)	422
Minispare wheel	425
Vehicle tool kit	422
② Rear lamps	448
③ Rear window, defrosting	189
④ Fuel filler flap	320
Refueling	320
Gasoline	492
⑤ Doors	
Locking and unlocking	36, 62, 100
Locking/unlocking in an emergency	427

Item	Page
⑥ Exterior rear view mirror	
Adjusting	47
Auto-dimming rear view mirrors	186
⑦ Tires and wheels	331
Checking tire inflation pressure	341
Run Flat Indicator (Canada only)	342
Tire Pressure Monitoring (USA only)	344
General information	331
TIREFIT Kit (CLK 63 AMG)	452
Vehicle tool kit	422
Minispare wheel	458
Flat tire	452
⑧ Towing	469
Installing towing eye bolt	470
⑨ Front lamps	446

Item	Page
⑩ Hood, opening	323
Engine oil	325
Coolant	328
Battery	329
⑪ Windshield wipers	56
Wiper blades, replacing	450
Wiper blades, cleaning	373
⑫ Windshield	
Front window, defrosting	191, 201
Cleaning with wiper fluid	57
Cleaning	373
⑬ Soft top	
Opening and closing	260
Opening and closing in an emergency	420
Roll bars	82
Cleaning	370

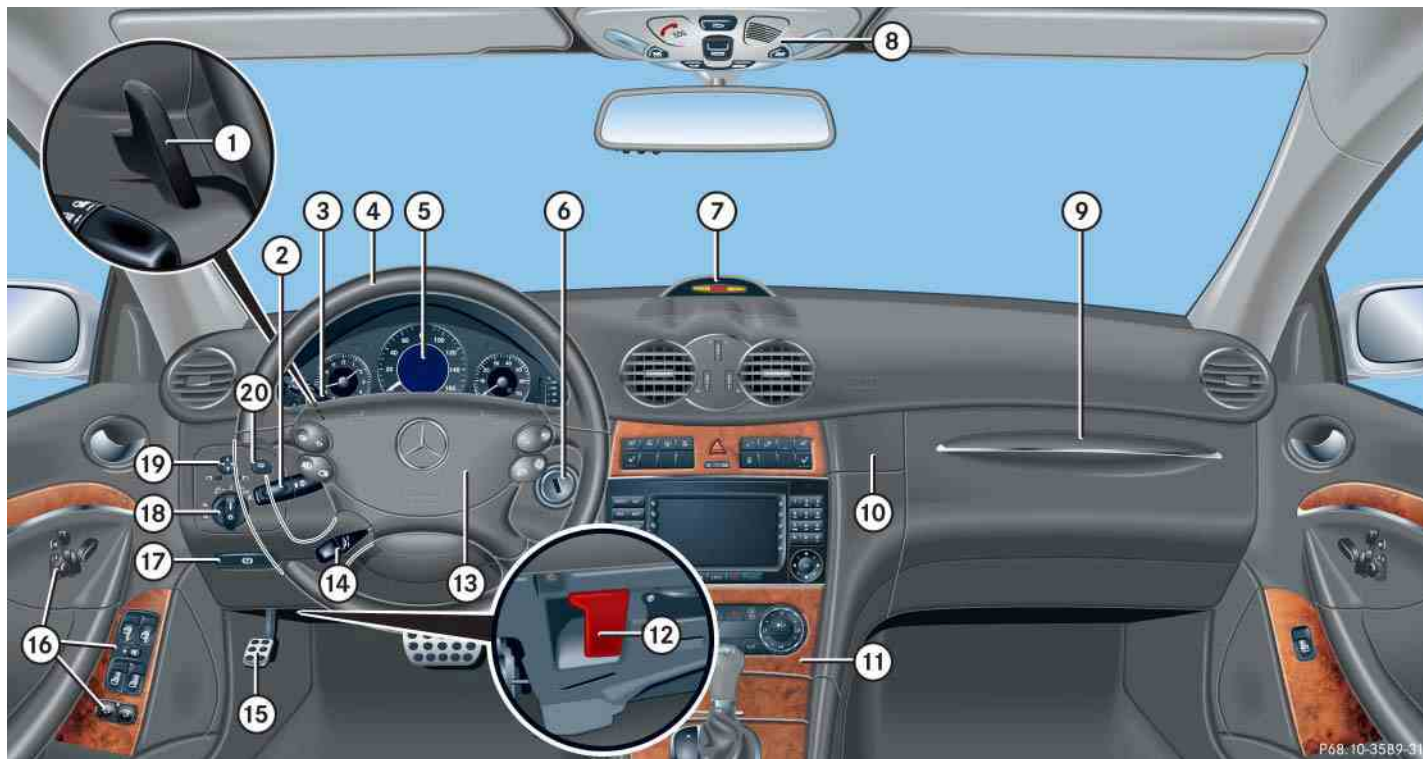

P48-10-35B9-31







Item	Page
① Steering wheel gearshift paddles*	180
② Combination switch	
• Turn signals	56
• Windshield wipers	56
• High beam	55
③ Cruise control lever	267
④ Multifunction steering wheel	30, 142
⑤ Instrument cluster	28, 138
⑥ Starter switch	38
⑦ Front Parktronic* warning indicator (Canada all vehicles, USA only CLK 63 AMG cabriolet)	271







Item	Page
⑧ Overhead control panel	33
⑨ Glove box	285
⑩ Storage box	285
⑪ Center console	31, 32
⑫ Hood lock release	324
⑬ Horn	
⑭ Steering wheel adjustment stalk	45
⑮ Parking brake pedal	53
⑯ Door control panel	34
⑰ Parking brake release	53
⑱ Exterior lamp switch	55, 129
⑲ Exterior rear view mirror adjustment	47
⑳ Headlamp washer switch*	185





Instrument cluster



P54.32-5243-31

Item	Page
①  Left turn signal indicator lamp	56
②  ESP® warning lamp	384
③ Speedometer	
④ Multifunction display	141
⑤  Distance warning lamp	
Warning lamp without function. It illuminates with the ignition on. It should go out when the engine is running.	
⑥  Right turn signal indicator lamp	56
⑦ Coolant temperature indicator with:	139
 Coolant temperature warning lamp	382
⑧ Tachometer with:	140
 Supplemental Restraint System (SRS) indicator lamp	64, 387

Item	Page
 Antilock Brake System (ABS) indicator lamp	378
 Seat belt telltale	79, 385
 High beam headlamp indicator lamp	133
 Low beam headlamp indicator lamp	129
⑨ Main odometer with:	
• Gear selector lever position	174
• Program mode	178
⑩ Clock with:	140
 Brake warning lamp, USA only	380
 Brake warning lamp, Canada only	380

Item	Page
 Engine malfunction indicator lamp, USA only	381
 Engine malfunction indicator lamp, Canada only	381
 Combination low tire pressure/TPMS malfunction telltale	388
 Roll bar warning lamp (CLK cabriolet)	385
⑪ Fuel display with:	
 Fuel reserve warning lamp	385
⑫ Reset button for:	
• Resetting trip odometer	139
• Adjusting instrument cluster illumination	138
• Confirming new time settings	160

Multifunction steering wheel



	Item	Page
①	Multifunction display	141
	Operating control system	142
②	Selecting the submenu or setting the volume: Press button	
	up / to increase	
	down / to decrease	
③	Telephone*: Press button	
	to take a call	170
	to dial a call	170
	to end a call	170
	to reject an incoming call	170

	Item	Page
④	Menu systems: Press button	
	for next menu	
	for previous menu	
⑤	Moving within a menu: Press button	
	for next display	
	for previous display	

▼ Center console

Upper part



CLK coupe

Item	Page
① Seat heater*, driver's side	125
Seat ventilation*, driver's side	126
② Parktronic system* deactivation switch (Canada all vehicles, USA only CLK 63 AMG cabriolet)	274
③ Rear window sunshade* switch (CLK coupe Canada only)	188
④ ESP® control switch	92
⑤ Hazard warning flasher on/off switch	135
⑥ Central unlocking switch	119
Central locking switch	119
⑦ Switch for folding (CLK coupe) or lowering (CLK cabriolet) rear seat head restraints	121

Item	Page
⑧ Anti-theft alarm system indicator lamp	97
⑨ Seat heater*, passenger side	125
Seat ventilation*, passenger side	126
⑩ Front passenger front air bag off indicator lamp	76, 390
⑪ Audio system,	151
or COMAND* (see separate operating instructions)	
⑫ Climate control	190
Automatic climate control	200
Rear window defroster	189

Center console

Lower part

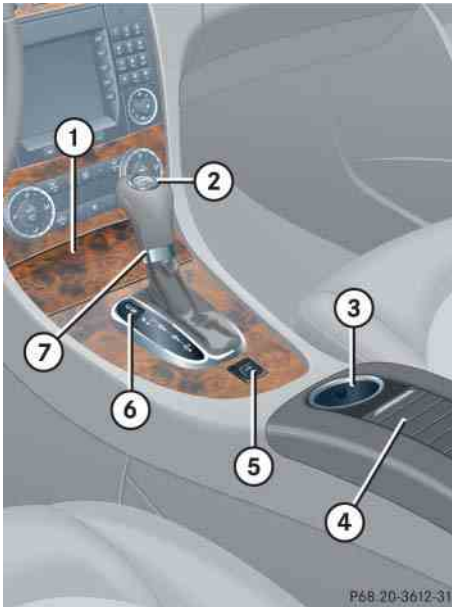

CLK cabriolet

	Item	Page
①	Ashtray	289
	Cigarette lighter	290
②	KEYLESS-GO* start/stop button	39
③	Cup holder	287
④	Storage compartment with cup holder and telephone* compartment in center armrest.	287 288
⑤	Soft top switch (CLK cabriolet)	260
⑥	Program mode selector switch for automatic transmission	
	• Automatic shift program	178
	• Manual shift program (CLK 63 AMG cabriolet)	182
⑦	Gear selector lever for automatic transmission	172

▼ Overhead control panel



CLK coupe

Item	Page
① Rear interior lighting on/off (CLK coupe)	137
② Power tilt/sliding sunroof* (CLK coupe)	256
③ Right reading lamp on/off	137
④ Interior lighting control	136
⑤ Interior rear view mirror	47, 185
⑥ Garage door opener*	301
⑦ Hands-free microphone for Tele Aid (emergency call system) and telephone*	292
⑧ Left reading lamp on/off	137
⑨ Tele Aid (emergency call system) button	295

Door control panel



	Item	Page
①	Inside door handle	109
②	Seat adjustment	42, 120
③	Memory function (for storing seat, exterior mirror and steering wheel settings)	127
④	Switches for opening/closing front door windows	250
⑤	Rear window override switch	88
⑥	Switches for opening/closing rear windows	250
⑦	Remote trunk opening switch	111
	Remote trunk opening/closing* switch	111

Unlocking

Adjusting

Driving

Parking and locking

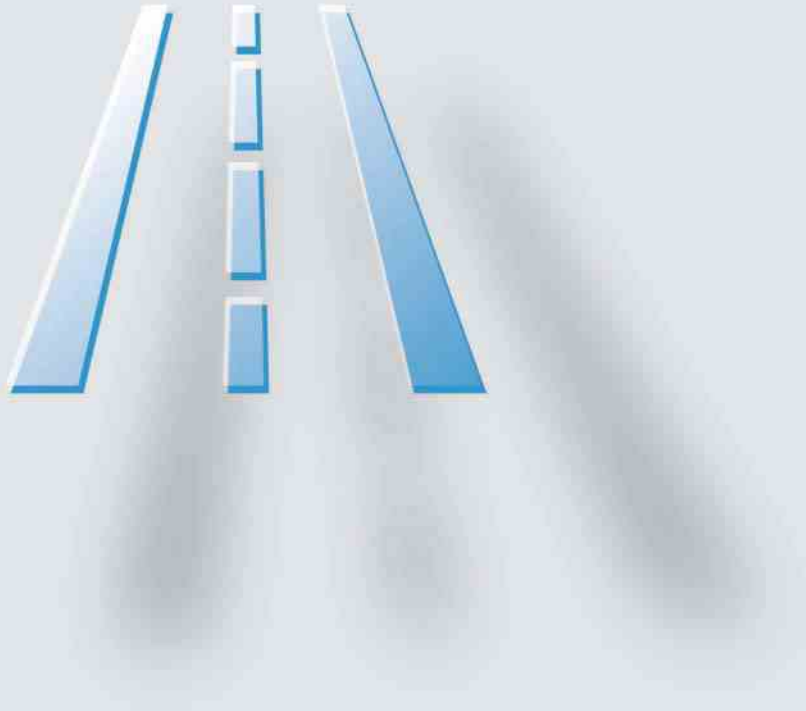

Unlocking





The “Getting started” section provides an overview of the vehicle’s most basic functions. First-time Mercedes-Benz owners should pay special attention to the information given here.

If you are already familiar with the basic functions described here, the “Controls in detail” section will provide you with further information. The corresponding page references are located at the end of each segment.

Unlocking with the SmartKey



SmartKey with remote control

- ①  Lock button
- ②  Opening button for trunk
- ③  Unlock button
- ④  Panic button (▷ page 89)

- ▶ Press unlock button  on the SmartKey.
 - All turn signal lamps flash once.
 - An acoustic signal sounds once. For more information, see “Factory setting” (▷ page 106).
 - The locking knobs in the doors move up.
 - The anti-theft alarm system is disarmed.
- ▶ Enter the vehicle and insert the SmartKey in the starter switch.

Warning!

When leaving the vehicle, always remove the SmartKey from the starter switch, take it with you, and lock the vehicle. Do not leave children unattended in the vehicle, or with access to an unlocked vehicle. A child's unsupervised access to a vehicle could result in an accident and/or serious personal injury.

i *Opening a door causes the windows on that side of the car to open slightly. They will return to the up position when the door is closed.*

For more information, see “SmartKey” (▷ page 100).

Unlocking with KEYLESS-GO*

With the KEYLESS-GO function, you can lock and unlock the vehicle without using the remote control buttons on the SmartKey and start the engine without inserting the SmartKey in the starter switch.

i *To unlock the vehicle, the SmartKey with KEYLESS-GO must be outside the vehicle, no further than approximately 3 feet (1 meter) away from the door to be opened.*

Warning!

When leaving the vehicle, always take the SmartKey with KEYLESS-GO with you, and lock the vehicle. Do not leave children unattended in the vehicle, or with access to an unlocked vehicle. A child's unsupervised access to a vehicle could result in an accident and/or serious personal injury.

- ▶ Pull an outside door handle.
 - All turn signal lamps flash once.
 - An acoustic signal sounds once. For more information, see “Factory setting” (▷ page 106).
 - The locking knobs in the doors move up.
 - The anti-theft alarm system is disarmed.

- ▶ Enter the vehicle.

i *Opening a door causes the windows on that side of the car to open slightly. They will return to the up position when the door is closed.*

For more information, see “SmartKey with KEYLESS-GO*” (▷ page 103).

Unlocking

Starter switch positions

Warning!



When leaving the vehicle, always remove the SmartKey or SmartKey with KEYLESS-GO* from the starter switch, take it with you, and lock the vehicle. Do not leave children unattended in the vehicle, or with access to an unlocked vehicle. A child's unsupervised access to a vehicle could result in an accident and/or serious personal injury.

SmartKey



Starter switch

- 0 For removing SmartKey
The steering is locked when the SmartKey is removed from the starter switch.
- 1 Power supply for some electrical consumers, such as seat adjustment
- 2 Ignition (power supply for all electrical consumers) and driving position
All lamps (except low beam headlamp indicator lamp, high beam headlamp indicator lamp, and turn signal indicator lamps unless activated) in the instrument cluster come on when the ignition is switched on, have it checked and replaced if necessary. If a lamp in the instrument cluster remains on after starting the engine or comes on while driving, refer to “Lamps in instrument cluster” (▷ page 378).
- 3 Starting position

i When you switch on the ignition, the indicator and warning lamps (except low beam headlamp indicator lamp, high beam headlamp indicator lamp, and turn signal indicator lamps unless activated) in the instrument cluster come on. The indicator and warning lamps (except low beam headlamp indicator lamp, high beam headlamp indicator lamp, and turn signal indicator lamps if activated) will go out when the engine is running. This indicates that the respective systems are operational.

i The SmartKey can only be removed from the starter switch with the gear selector lever in position **P**.

i If the SmartKey is left in starter switch position **0** for an extended period of time, it can no longer be turned in the switch. In this case, the steering is locked. To unlock, remove SmartKey from starter switch and reinsert.

! If the SmartKey cannot be turned in the starter switch, the battery may not be sufficiently charged.

- Check the battery and charge it if necessary (▷ page 464).
- Get a jump start (▷ page 467).

To prevent accelerated battery discharge or a completely discharged battery, always remove the SmartKey from the starter switch when the engine is not in operation.

For more information, see “SmartKey” (▷ page 100).

For information on starting the engine using the SmartKey, see “Starting with the SmartKey” (▷ page 52).

SmartKey with KEYLESS-GO*

Pressing the KEYLESS-GO start/stop button on the gear selector lever corresponds to turning the SmartKey to the various starter positions.

If you firmly depress the brake pedal during pressing the KEYLESS-GO start/stop button, the engine starts automatically.

You can also use the SmartKey with KEYLESS-GO like a normal SmartKey.

i The function of the SmartKey overrides the KEYLESS-GO function.

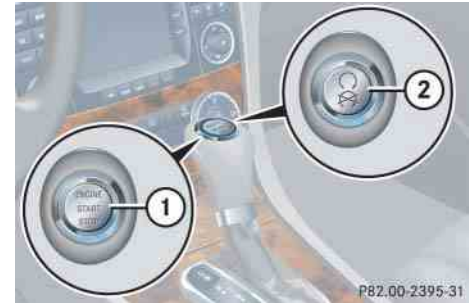

KEYLESS-GO start/stop button

- ① USA only
- ② Canada only

The SmartKey with KEYLESS-GO must be located in the vehicle.

- ▶ Make sure the gear selector lever is set to **P**.
- ▶ Do not depress the brake pedal.

Unlocking

Position 0

Before you press the KEYLESS-GO start/stop button, the vehicle's on-board electronics have status **0** (as with SmartKey removed).

Position 1

- ▶ Press the KEYLESS-GO start/stop button once.

This supplies power for some electrical consumers, such as seat adjustment.

i *If you now press the KEYLESS-GO start/stop button*

- *once again, the ignition (position 2) is switched on.*
- *twice, the power supply is again switched off.*

Ignition (or position 2)

- ▶ Press the KEYLESS-GO start/stop button twice.

This supplies power for all electrical consumers. All the lamps (except low beam headlamp indicator lamp, high beam headlamp indicator lamp, and turn signal indicator lamps unless activated) in the instrument cluster come on. If a lamp in the instrument cluster fails to come on when the ignition is switched on, have it checked and replaced if necessary. If a lamp in the instrument cluster remains on after starting the engine or comes on while driving, refer to “Lamps in instrument cluster” (▷ page 378).

i *If you now press the KEYLESS-GO start/stop button once, the power supply is again switched off.*

i *When you switch on the ignition, the indicator and warning lamps (except low beam headlamp indicator lamp, high beam headlamp indicator lamp, and turn signal indicator lamps unless activated) in the instrument cluster come on. The indicator and warning lamps (except low beam headlamp indicator lamp, high beam headlamp indicator lamp, and turn signal indicator lamps if activated) will go out when the engine is running. This indicates that the respective systems are operational.*

For more information, see “SmartKey with KEYLESS-GO*” (▷ page 103).

For information on starting the engine using the KEYLESS-GO start/stop button, see “Starting with KEYLESS-GO*” (▷ page 52).

▼ Adjusting

Warning!



All seat, head restraint, steering wheel, and rear view mirror adjustments, as well as fastening of seat belts, must be done before the vehicle is put into motion.

Seats

Warning!



Do not adjust the driver's seat while driving. Adjusting the seat while driving could cause the driver to lose control of the vehicle.

Never ride in a moving vehicle with the seat back in an excessively reclined position as this can be dangerous. You could slide under the seat belt in a collision. If you slide under it, the belt would apply force at the abdomen or neck. That could cause serious or fatal injuries. The seat back and seat belts provide the best restraint when the wearer is in a nearly upright position and belts are properly positioned on the body.

Warning!



Your seat must be adjusted so that you can correctly fasten your seat belt.

Observe the following points:

- Adjust the backrest until your arms are slightly angled when holding the steering wheel.
- Adjust the seat to a comfortable seating position that still allows you to reach the accelerator/brake pedal safely. The position should be as far back as possible with the driver still able to operate controls properly.
- Adjust the head restraint so that it is as close to the head as possible and the center of the head restraint supports the back of the head at eye level.
- Never place hands under the seat or near any moving parts while a seat is being adjusted.

Failure to do so could result in an accident and/or serious personal injury.

Warning!



When leaving the vehicle, always remove the SmartKey or SmartKey with KEYLESS-GO* from the starter switch, take it with you, and lock the vehicle.

Even with the SmartKey or SmartKey with KEYLESS-GO* removed from the starter switch, or the SmartKey with KEYLESS-GO* removed from the vehicle, the power seats can be operated when the respective door is open. Therefore, do not leave children unattended in the vehicle, or with access to an unlocked vehicle. Unsupervised use of vehicle equipment may cause an accident and/or serious personal injury.

Adjusting

Warning!



According to accident statistics, children are safer when properly restrained in the rear seating positions than in the front seating position. Thus, we strongly recommend that children be placed in the rear seats whenever possible. Regardless of seating position, children 12 years old and under must be seated and properly secured in an appropriate infant, or toddler restraint, or booster seat recommended for the size and weight of the child. For additional information, see “Children in the vehicle” (▷ page 83).

A child’s risk of serious or fatal injuries is significantly increased if the child restraints are not properly secured in the vehicle and/or the child is not properly secured in the child restraint.

Seat adjustment

The seat adjustment switches are located on the respective door.

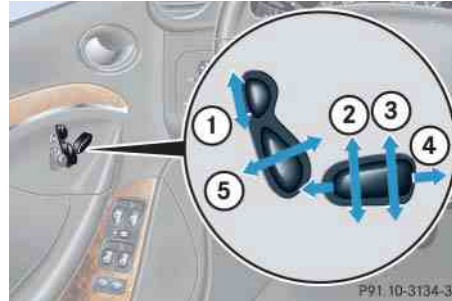

- ① Head restraint height
- ② Seat height
- ③ Seat cushion tilt
- ④ Seat fore and aft adjustment
- ⑤ Backrest tilt

- ▶ Switch on the ignition (▷ page 38).
- or
- ▶ Open the respective door.

i The memory function (▷ page 127) lets you store the settings for the seat position together with the settings for the steering wheel and the exterior rear view mirrors.

Seat fore and aft adjustment

- ▶ Press switch forward or backward in the direction of arrow ④.

! When moving the seats, make sure there are no items in the footwell or behind the seats; otherwise you could damage the seats.

Seat height

- ▶ Press switch up or down in the direction of arrow ②.

Seat cushion tilt

- ▶ Press switch up or down in the direction of arrow ③ until your upper legs are lightly supported.

Seat backrest tilt

- ▶ Press switch forward or backward in the direction of arrow ⑤.

Head restraint height

- ▶ Press switch up or down in the direction of arrow ①.

Warning!

For your protection, drive only with properly positioned head restraints.

Adjust the head restraint so that it is as close to the head as possible and the center of the head restraint supports the back of the head at eye level. This will reduce the potential for injury to the head and neck in the event of an accident or similar situation.

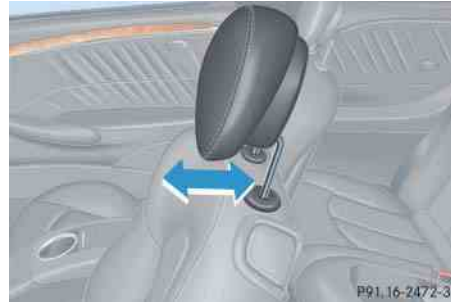
Head restraint adjusting

Manually adjust the head restraint.

- ▶ Push or pull the head restraint cushion to the desired position.

For more information, see “Seats” (▷ page 120).

Folding front seat backrests forward

- ① Release lever

Folding backrests forward

- ▶ Pull release lever ① forward and fold the backrest forward.

The head restraint will automatically move down.

Adjusting

Folding backrests back

- ▶ Fold and press the backrest rearward until it engages in driving position.

The head restraint returns to its previous position.

i *In addition to the front seat backrests, the front seat cushions can also be shifted forward to permit easy access to the rear whenever the seat is located in the rear half of its adjustment range. Pivot backrest forward by pulling the release lever until the seat moves in a combined forward and upward movement.*

! *When moving the seat, make sure there are no items in the footwell or behind the seats. Otherwise you could damage the seats.*

Warning!



The seat belts provide protection only with the backrest locked in place. Therefore, the backrest must be locked in place with the vehicle in motion. Do not drive the vehicle when the backrest is not locked in place.

When leaving the vehicle, always remove the SmartKey or SmartKey with KEYLESS-GO* from the starter switch, take it with you, and lock the vehicle.

The power seats can also be operated with the driver's or passenger door open. Do not leave children unattended in the vehicle or with access to an unlocked vehicle. Unsupervised use of vehicle equipment may cause an accident and/or serious personal injury.

Never place hands under seat or near any moving parts during a seat adjustment procedure.

For information on additional convenience features permitting easy entry and exit, see "Easy-entry/exit feature" (▶ page 45).

Steering wheel

Warning!



Do not adjust the steering wheel while driving. Adjusting the steering wheel while driving could cause the driver to lose control of the vehicle.

When leaving the vehicle, always remove the SmartKey or SmartKey with KEYLESS-GO* from the starter switch, take it with you, and lock the vehicle.

Even with the SmartKey or SmartKey with KEYLESS-GO* removed from the starter switch, or the SmartKey with KEYLESS-GO* removed from the vehicle, the steering wheel adjustment feature can be operated when the driver's door is open. Therefore, do not leave children unattended in the vehicle, or with access to an unlocked vehicle. Unsupervised use of vehicle equipment may cause an accident and/or serious personal injury.

Steering wheel adjustment

The stalk for steering wheel adjustment is located on the lower left of steering column.



- ① Adjusting steering column, in or out
- ② Adjusting steering column, up or down

► Switch on the ignition (▷ page 38).

or

► Open the driver's door.

Adjusting steering column in or out

► Move stalk forward or back in direction of arrow ① until a comfortable steering wheel position is reached with your arms slightly bent at the elbow.

Adjusting steering column up or down

► Move stalk up or down in direction of arrow ②.

Make sure your legs can move freely and all the displays (including malfunction and indicator lamps) on the instrument cluster are clearly visible.

i *The memory function (▷ page 127) lets you store settings for the steering wheel together with the settings for the exterior rear view mirrors and the seat position.*

Easy-entry/exit feature

This feature allows for easier entry into and exit from the vehicle. When entering and exiting the vehicle, the steering wheel is in its uppermost position.

The easy-entry/exit feature can be activated or deactivated in the Convenience submenu of the control system (▷ page 166).

Warning!



You must make sure no one can become trapped or injured by the moving steering wheel when the easy-entry/exit feature is activated.

To stop steering wheel movement, do one of the following:

- Move steering wheel adjustment stalk (▷ page 45).
- Press the memory position switch (▷ page 128).



Adjusting

- ▷▷ Do not leave children unattended in the vehicle, or with access to an unlocked vehicle. Children could open the driver's door and unintentionally activate the easy-entry/exit feature, which could result in an accident and/or serious personal injury.

With the easy-entry/exit feature activated, the steering wheel will return to its last set position when you:

- close the driver's door with the ignition switched on,
or
- insert the SmartKey into the starter switch or press the KEYLESS-GO* start/stop button (▷ page 39) once with the driver's door closed.

i *The last set steering wheel position is stored when*

- *the ignition is switched off.*
- *the position is stored in memory (▷ page 128).*

With the easy-entry/exit feature activated, the steering wheel tilts upwards when you:

- remove the SmartKey from the starter switch,
or
- open the driver's door with the SmartKey in starter switch position **0** or **1** or the KEYLESS-GO* start/stop button (▷ page 39) in position **1**.

i *If the current position for the steering wheel is in the uppermost tilt position, the steering wheel will no longer be able to move upward when the easy-entry/exit feature is activated.*

The adjustment procedure is briefly interrupted when the engine is started.

Warning!



Let the system complete the adjustment procedure before setting the vehicle in motion. All steering wheel adjustment must be completed before setting the vehicle in motion. Driving off with the steering wheel still adjusting could cause the driver to lose control of the vehicle.

Mirrors

Adjust the interior and exterior rear view mirrors before driving so that you have a good view of the road and traffic conditions.

Interior rear view mirror

- ▶ Manually adjust the interior rear view mirror.

For more information, see “Rear view mirrors” (▷ page 185).

Exterior rear view mirrors

Warning!



Exercise care when using the passenger-side exterior rear view mirror. The mirror surface is convex (outwardly curved surface for a wider field of view). Objects in mirror are closer than they appear. Check your interior rear view mirror or glance over your shoulder before changing lanes.

The buttons are located above the exterior lamp switch.



- ① Adjustment button
- ② Passenger-side exterior rear view mirror button
- ③ Driver's side exterior rear view mirror button

- ▶ Switch on the ignition (▷ page 38).
- ▶ Press button ③ for the driver's side exterior rear view mirror or button ② for the passenger-side exterior rear view mirror.
- ▶ Push adjustment button ① up, down, left, or right, according to the desired setting.

! *If an exterior rear view mirror was forcibly pushed forward (hit from the rear) or forcibly pushed rearward (hit from the front), reposition it by applying firm pressure until it snaps into place. The mirror housing is now properly positioned and you can adjust the mirror normally.*

i *The memory function (▷ page 127) lets you store the setting for the exterior rear view mirrors together with the settings for the steering wheel and the driver's seat position.*

i *At low ambient temperatures, the exterior rear view mirrors will be heated automatically.*

For more information, see “Rear view mirrors” (▷ page 185).

Driving

Warning!



Make sure absolutely no objects are obstructing the pedals' range of movement. Keep the driver's footwell clear of all obstacles. If there are any floor mats or carpets in the footwell, make sure the pedals still have sufficient clearance.

During sudden driving or braking maneuvers, the objects could get caught between or beneath the pedals. You could then no longer brake or accelerate. This could lead to accidents and injury.

Fastening the seat belts

Warning!



Always fasten your seat belt before driving off. Always make sure your passengers are properly restrained, even those sitting in the rear.

Failure to wear and properly fasten and position your seat belt greatly increases your risk of injuries and their likely severity in an accident. You and your passengers should always wear seat belts.

If you are ever in an accident, your injuries can be considerably more severe without your seat belt properly buckled. Without your seat belt buckled, you are much more likely to hit the interior of the vehicle or be ejected from it. You can be seriously injured or killed.

In the same crash, the possibility of injury or death is lessened if you are wearing your seat belt. The air bags can only provide the protection they were designed to afford if the occupants are using their seat belts (▷ page 64).

Warning!



According to accident statistics, children are safer when properly restrained in the rear seating positions than in the front seating position. Thus, we strongly recommend that children be placed in the rear seats. Regardless of seating position, children 12 years old and under must be seated and properly secured in an appropriate infant restraint, toddler restraint, or booster seat recommended for the size and weight of the child. For additional information, see "Children in the vehicle" (▷ page 83).

A child's risk of serious or fatal injuries is significantly increased if the child restraints are not properly secured in the vehicle and/or the child is not properly secured in the child restraint.

Warning!

Never let more people ride in the vehicle than there are seat belts available. Be sure everyone riding in the vehicle is correctly restrained with a separate seat belt. Never use a seat belt for more than one person at a time.

Warning!

Never ride in a moving vehicle with the seat backrest in an excessively reclined position as this can be dangerous. You could slide under the seat belt in a collision. If you slide under it, the belt would apply force at the abdomen or neck. This could cause serious or even fatal injuries. The seat backrest and seat belt provide the best restraint when the wearer is in a nearly upright position and the belt is properly positioned on the body.

Warning!

Read and observe the additional warning notices printed in the “Safety and Security” section (▷ page 68).

The seat belt presenter for driver and passenger makes it easier to put on the seat belt.



① Seat belt presenter

The seat belt presenter ① slides out when the corresponding door is closed and the ignition is switched on (▷ page 38).

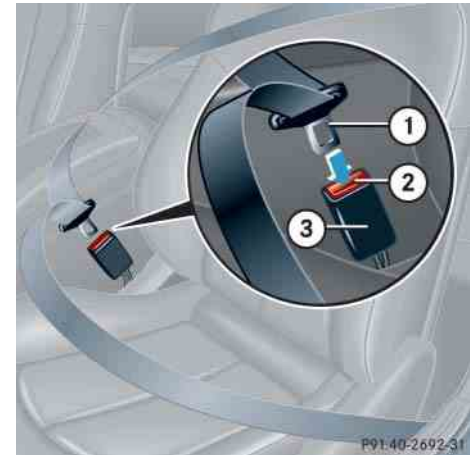

- ① Latch plate
- ② Release button
- ③ Buckle

Driving

- ▶ With a smooth motion, pull the belt out of the seat belt presenter.
 - ▶ Place the shoulder portion of the belt across the top of your shoulder and the lap portion across your hips.
 - ▶ Push latch plate ① into buckle ③ until it clicks.
 - ▶ If necessary, tighten the lap portion to a snug fit by pulling shoulder portion up.
- Position the lap belt as low as possible on your hips (over hip joint) and not across the abdomen.
 - Place the seat backrest in a position that is as upright as possible.
 - Never use a seat belt for more than one person at a time.
 - Do not fasten a seat belt around a person and another object at the same time.
 - When using a seat belt to secure infant restraints, toddler restraints or children in booster seats, always follow the child seat manufacturer's instructions.

Proper use of seat belts

- Do not twist the belt when fastening.
- Adjust seat belt so that the shoulder portion is located as close as possible to the middle of the shoulder (it should not touch the neck). Never pass the shoulder portion of the belt under your arm.
- Check your seat belt periodically during travel to make sure it is properly positioned.
- Make sure the seat belt is always fitted snugly. Take special care of this when wearing loose clothing.

Warning!



Do not pass belts over sharp edges. They could tear.

Do not allow the belt to get caught in the door or in the seat adjustment mechanism. This could damage the belt.

Never attempt to make modifications to seat belts. This could impair the effectiveness of the belts.

Do not bleach or dye seat belts as this may severely weaken them. In a crash they may not be able to provide adequate protection.

Damaged seat belts or belts that were highly stressed in an accident must be replaced. Contact an authorized Mercedes-Benz Center.

The seat belt presenter slides back:

- right after you push the latch plate ① into buckle ③ and hear it click.
- after approximately 60 seconds if you do not push latch plate ① into buckle ③.
- if your door is opened.
- if you turn the SmartKey in the starter switch to position **0**.
- if you release a front seat backrest and fold it forward.

Warning!



The seat belt presenter must be retracted while the vehicle is in motion. Only when the seat belt presenter is retracted can the seat belt be properly positioned on the body and protect the occupant as intended.

Starting the engine

Warning!



Inhalation of exhaust gas is hazardous to your health. All exhaust gas contains carbon monoxide (CO), and inhaling it can cause unconsciousness and possible death.

Do not run the engine in confined areas (such as a garage) which are not properly ventilated. If you think that exhaust gas fumes are entering the vehicle while driving, have the cause determined and corrected immediately. If you must drive under these conditions, drive with at least one window fully open.

Automatic transmission

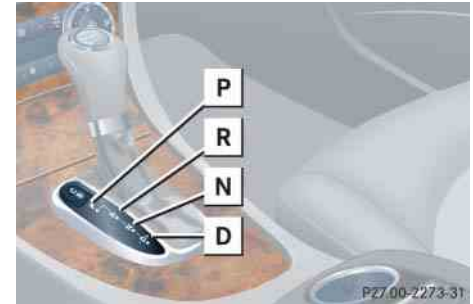

Gearshift pattern for automatic transmission

- P** Park position with gear selector lever lock
- R** Reverse gear
- N** Neutral
- D** Drive position

For more information, see “Automatic transmission” (▷ page 172).

Starting with the SmartKey

- ▶ Make sure the gear selector lever is set to **P**.
- ▶ Do not depress accelerator.
- ▶ Turn the SmartKey in the starter switch to position **3** (▷ page 38) and release it again immediately (“touch-start”).

The engine then starts automatically.

For information on turning off the engine with the SmartKey, see (▷ page 60).

Starting with KEYLESS-GO*

Warning!



As long as the SmartKey with KEYLESS-GO is in your vehicle, the vehicle can be started. Therefore, never leave children unattended in the vehicle, as they could otherwise accidentally start the engine.

When leaving the vehicle, always take the SmartKey with KEYLESS-GO with you and lock the vehicle. Do not leave children unattended in the vehicle, or with access to an unlocked vehicle.

You can start your vehicle without the SmartKey in the starter switch using the KEYLESS-GO start/stop button on the gear selector lever.

The SmartKey with KEYLESS-GO must be located in the vehicle.

- ▶ Make sure the gear selector lever is set to **P**.
- ▶ Do not depress accelerator.

- ▶ Depress the brake pedal during the starting procedure.

The gear selector lever lock is released.

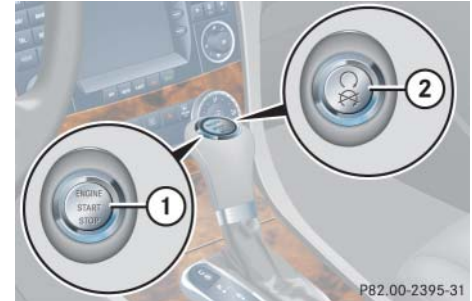

KEYLESS-GO start/stop button

- ① USA only
- ② Canada only

- ▶ Press KEYLESS-GO start/stop button once.

The engine starts if the SmartKey with KEYLESS-GO is in the vehicle.

For information on turning off the engine with KEYLESS-GO, see “Turning off the engine with KEYLESS-GO*” (▷ page 60).

Starting difficulties

If the SmartKey is left in starter switch position **0** for an extended period of time, it can no longer be turned in the switch. In this case, the steering is locked.

- ▶ To unlock, remove SmartKey from starter switch and reinsert.

If the engine does not start as described, carry out the following steps:

- ▶ If you are starting the engine with the SmartKey, turn SmartKey in starter switch to position **0** and repeat starting procedure.
- ▶ If you are starting the engine with KEYLESS-GO*: Close any doors that may be open to allow for better detection of the SmartKey with KEYLESS-GO*.
Or:
Start the engine with the SmartKey as radio signals from another source may be interfering with the SmartKey with KEYLESS-GO*.

- ▶ Repeat the starting procedure (▷ page 51).

Remember that extended starting attempts can drain the battery.

- ▶ Get a jump start (▷ page 467).

If the engine does not start after several starting attempts, there could be a malfunction in the engine electronics or in the fuel supply system.

- ▶ Contact an authorized Mercedes-Benz Center or call Roadside Assistance.

Parking brake

Warning!



When leaving the vehicle, always remove the SmartKey or SmartKey with KEYLESS-GO* from the starter switch, take it with you, and lock the vehicle. Do not leave children unattended in the vehicle, or with access to an unlocked vehicle. Children could release the parking brake, which could result in an accident and/or serious personal injury.

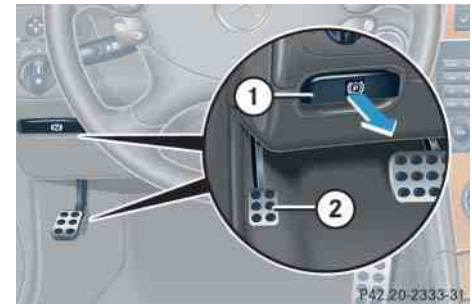

- ① Release handle
- ② Parking brake pedal



Driving

- ▷▷ Release the parking brake by pulling on release handle ①.

The indicator lamp **BRAKE** (USA only) or **(P)** (Canada only) in the clock goes out.

Driving

- ▶ Depress the brake pedal.
- ▶ Move gear selector lever to position **D** or **R**.

i Wait for the gear selection process to complete before setting the vehicle in motion.

- ▶ Release the brake pedal.
- ▶ Carefully depress the accelerator pedal.

! If you hear a warning signal and the message **Release Parking Brake** appears in the multifunction display when driving off, you have forgotten to release the parking brake.

Release the parking brake (▷ page 53).

i At vehicle speeds of approximately 9 mph (15 km/h), the automatic central locking system engages and the locking knobs drop down.

The automatic door lock feature can be deactivated (▷ page 166).

You can open a locked door from the inside. Open door only when conditions are safe to do so.

! Simultaneously depressing the accelerator pedal and applying the brakes reduces engine performance and causes premature brake and drivetrain wear.

After a cold start, the automatic transmission shifts at a higher engine revolution. This allows the catalytic converter to reach its operating temperature earlier.

Warning!



On slippery road surfaces, never downshift in order to obtain braking action. This could result in drive wheel slip and reduced vehicle control. Your vehicle's ABS will not prevent this type of loss of control.

! Place the gear selector lever in position **R** or **P** only when the vehicle is stopped in order to avoid damaging the transmission.

! Do not run cold engine at high engine speeds. Running a cold engine at high engine speeds may shorten the service life of the engine.

CLK 63 AMG:

At low engine temperatures below +68°F (+20°C), the engine's maximum speed is restricted in order to protect it from damage. Avoid driving your vehicle at full speed when the engine is cold to prevent premature engine wear and/or diminished comfort.

Warning!

It is dangerous to shift the gear selector lever out of **P** or **N** if the engine speed is higher than idle speed. If your foot is not firmly on the brake pedal, the vehicle could accelerate quickly forward or in reverse. You could lose control of the vehicle and hit someone or something. Only shift into gear when the engine is idling normally and when your right foot is firmly on the brake pedal.

For more information on driving, see “Driving instructions” (▷ page 309).

Switching on headlamps**Low beam headlamps****Exterior lamp switch**

- | | | |
|---|--|--|
| 1 | | Off |
| 2 | | Low beam headlamps or high beam headlamps. |

- ▶ Turn the exterior lamp switch to position

The low beam headlamps and the low beam headlamp indicator lamp

in the instrument cluster comes on (▷ page 28).

High beam**Combination switch**

- ① High beam
- ② High beam flasher

- ▶ Push the combination switch in direction of arrow ①.

The high beam headlamps and the high beam headlamp indicator lamp

in the instrument cluster comes on (▷ page 28).

For more information on headlamps, see “Lighting” (▷ page 129).

Driving



Turn signals



Combination switch

- ① Turn signals, right
- ② Turn signals, left

- ▶ Press the combination switch in direction of arrow ① or ②.

The corresponding turn signal indicator lamp  or  in the instrument cluster flashes (▷ page 28).

The combination switch resets automatically after major steering wheel movements.

i To signal minor directional changes such as changing lanes, press the combination switch only to the point of resistance and release. The corresponding turn signals will flash three times.

Windshield wipers



Combination switch

- ① Single wipe
Wiping with windshield washer fluid
- ② Switching on windshield wipers

- ▶ Switch on the ignition (▷ page 38).

! Do not operate the windshield wipers when the windshield is dry. Dust that accumulates on a windshield might scratch the glass and/or damage the wiper blades when wiping occurs on a dry windshield. If it is necessary to operate the windshield wipers in dry weather conditions, always operate the windshield wipers with windshield washer fluid (▷ page 57).

Switching on windshield wipers

- ▶ Turn the combination switch to the desired position depending on the intensity of the rain.
 - 0 Windshield wipers off
 - I Intermittent wiping
 - II Normal wiper speed
 - III Fast wiper speed

Intermittent wiping

! Do not leave windshield wipers on an intermittent setting when the vehicle is taken to an automatic car wash or during windshield cleaning. Windshield wipers will operate in the presence of water sprayed on the windshield, and windshield wipers may be damaged as a result.

! If you have set intermittent wiping, dirt on the surface of the rain sensor or optical effects may cause the windshield wipers to wipe in an undesired fashion. This could then damage the windshield wiper blades or scratch the windows. You should therefore switch off the windshield wipers when weather conditions are dry.

Intermittent wiping interval is dependent on wetness of windshield.

- ▶ Turn the combination switch to position **I**.

After the initial wipe, pauses between wipes are automatically controlled by the rain sensor.

i Intermittent wiping is interrupted when the vehicle is at a standstill and a door is opened. This protects persons getting into or out of the vehicle from being sprayed.

Intermittent wiping will be continued when

- all doors are closed
and
- the gear selector lever is in position **D** or **R**
or
- the wiper setting is changed using the combination switch.

Single wipe

- ▶ Press the combination switch briefly in direction of arrow ① (▷ page 56) to the resistance point.

The windshield wipers wipe one time without washer fluid.

Wiping with windshield washer fluid

- ▶ Press the combination switch in direction of arrow ① (▷ page 56) past the resistance point.

The windshield wipers operate with washer fluid.

i To prevent smears on the windshield, or noisy/chattering wiper blades, wipe with windshield washer fluid every now and then even when it is raining.

For information on filling up the washer reservoir, see “Windshield washer system and headlamp cleaning system*” (▷ page 330).



▷▷ **!** *If anything blocks the windshield wipers (leaves, snow, etc.), switch them off immediately.*

- *For safety reasons, stop the vehicle in a safe location and,*
 - *remove SmartKey from starter switch*
 - *or*
 - *turn off the engine by pressing the KEYLESS-GO* start/stop button and open the driver's door (with the driver's door open, starter switch is in position 0, same as with SmartKey removed from starter switch)*
- *before attempting to remove any blockage.*
- *Remove blockage.*
- *Turn the windshield wipers on again.*

If the windshield wipers fail to function at all with the combination switch in position I,

- *set the combination switch to the next higher wiper speed*
- *have the windshield wipers checked at the nearest authorized Mercedes-Benz Center.*

Problems while driving

The engine runs erratically and misfires

- An ignition cable may be damaged.
- The engine electronics may not be operating properly.
- Unburned gasoline may have entered the catalytic converter and damaged it.
- ▶ Give very little gas.
- ▶ Have the problem repaired at an authorized Mercedes-Benz Center as soon as possible.

The coolant temperature is above 248°F (120°C)

The coolant is too hot and is no longer cooling the engine.

- ▶ Stop the vehicle in a safe location as soon as possible and turn off the engine. Allow engine and coolant to cool off.

- ▶ Check the coolant level and add coolant if necessary (▷ page 328).

In case of accident

If the vehicle is leaking gasoline:

- ▶ Do not start the engine under any circumstances.
- ▶ Notify local fire and/or police authorities.

If the extent of the damage cannot be determined:

- ▶ Contact an authorized Mercedes-Benz Center or call Roadside Assistance.

If no damage can be determined on the

- major assemblies
- fuel system
- engine mount:
- ▶ Start the engine in the usual manner.

▼ Parking and locking

You have now completed your first drive. You have properly stopped and parked your vehicle. End your drive as follows.

Warning!



With the engine not running, there is no power assistance for the brake and steering systems. In this case, it is important to keep in mind that a considerably higher degree of effort is necessary to brake and steer the vehicle.

Warning!



Do not park this vehicle in areas where combustible materials such as grass, hay or leaves can come into contact with the hot exhaust system, as these materials could be ignited and cause a vehicle fire.

To reduce the risk of personal injury, or damage to the vehicle or the vehicle drivetrain, as a result of vehicle movement, always do the following before turning off the engine and leaving the vehicle:

- Keep right foot firmly on brake pedal.
- Firmly depress parking brake pedal.
- Move the gear selector lever to position **P**.
- Slowly release brake pedal.
- When parked on an incline, always turn the front wheels towards the road curb.
- Turn the SmartKey or the SmartKey with KEYLESS-GO* to starter switch position **0** and remove, or press KEYLESS-GO* start/stop button.
- Take the SmartKey or the SmartKey with KEYLESS-GO* with you and lock the vehicle when leaving.

Parking brake

Warning!



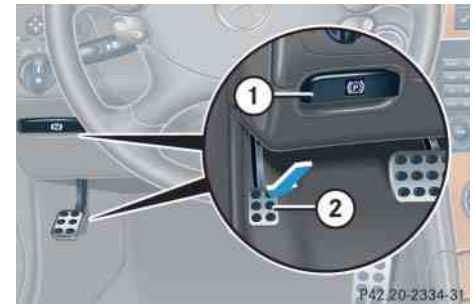

Engaging the parking brake while the vehicle is in motion can cause the rear wheels to lock up. You could lose control of the vehicle and cause an accident. In addition, the vehicle's brake lights do not light up when the parking brake is engaged.



- ① Release handle
- ② Parking brake pedal

► Step firmly on parking brake pedal ②. ▷▷

Parking and locking

- ▷▷ When the engine is running, the warning lamp  (USA only) or  (Canada only) in the clock will be illuminated.

Warning!



When leaving the vehicle, always remove the SmartKey or SmartKey with KEYLESS-GO* from the starter switch, take it with you, and lock the vehicle. Do not leave children unattended in the vehicle, or with access to an unlocked vehicle. Children could release the parking brake and/or move the gear selector lever from position **P**, either of which could result in an accident and/or serious personal injury.

Position **P** alone may not prevent your vehicle from moving, possibly hitting people or objects. Always set the parking brake in addition to shifting to position **P** (▷ page 174).

When parked on an incline, always turn the front wheels towards the road curb.

Getting out of your vehicle without taking the above measurements to secure it is dangerous.

Switching off headlamps

- ▶ Turn the exterior lamp switch to  (▷ page 129).

Turning off the engine

- ▶ Place the gear selector lever in position **P**.
- ▶ Apply the parking brake (▷ page 59).

 *Always set the parking brake in addition to shifting to position **P**.*

On slopes, turn the front wheels towards the curb.

Turning off the engine with the SmartKey

- ▶ Turn the SmartKey in the starter switch to position **0** (▷ page 38).
- ▶ Remove the SmartKey from the starter switch. The immobilizer is activated.

 *The SmartKey can only be removed from the starter switch with the gear selector lever in position **P**.*

Turning off the engine with KEYLESS-GO*

- ▶ Press the KEYLESS-GO start/stop button to shut off the engine.

With the driver's door closed, the starter switch is now in position **1**. With the driver's door opened, the starter switch is set to position **0**, same as SmartKey removed from starter switch (▷ page 38).

i If you hear a warning signal, you have tried to turn off the engine while the gear selector lever was not in **P**.

In addition, the message **Selector Lever In Park** appears in the multifunction display.

Place the gear selector lever in **P**.

Releasing seat belts

- ▶ Press the seat belt release button (▷ page 49).

Allow the retractor to completely rewind the seat belt by guiding the latch plate.

! Make sure the seat belt retracts fully so that the seat belt and/or latch plate cannot get caught or pinched in the door or in the seat mechanism. This can damage the seat belt and impair the effectiveness of the seat belt, and/or cause damage to the door and/or door trim panel. Such damage is not covered by the Mercedes-Benz Limit Warranty.

Damaged seat belts must be replaced. Contact an authorized Mercedes-Benz Center.

Locking

Warning!



To prevent possible personal injury, always keep hands and fingers away from the door openings when closing the doors. Be especially careful when small children are around.

Before closing doors, make sure there is no possibility of someone getting caught in a door during closing.

Warning!



When leaving the vehicle, always remove the SmartKey or SmartKey with KEYLESS-GO* from the starter switch, take it with you, and lock the vehicle. Do not leave children unattended in the vehicle, or with access to an unlocked vehicle. A child's unsupervised access to a vehicle could result in an accident and/or serious personal injury.

- ▶ Exit the vehicle, take the SmartKey or the SmartKey with KEYLESS-GO* with you, and close all doors and the trunk lid.

i If you hear a warning signal you have forgotten to switch off the low beam headlamps or the parking lamps before opening the driver's door.

In addition the message **Switch Off Lights** appears in the multifunction display.

Switch off the low beam headlamps or the parking lamps.

If the message **Switch Off Lights** or **Remove Key** appears in the multifunction display remove the SmartKey from the starter switch or switch off the automatic headlamp mode.

! Failure to switch off the exterior lamps when leaving the vehicle may result in a discharged battery.

i Opening a door causes the windows on that side of the car to open slightly. They will return to the up position when the door is closed.

Parking and locking

Locking with the SmartKey

- ▶ Press lock button  on the SmartKey (▷ page 36).

With the trunk and both doors closed:

- All turn signal lamps flash three times.
- An acoustic signal sounds three times.
For more information, see “Factory setting” (▷ page 106).
- The locking knobs in the doors move down.
- The anti-theft alarm system is armed.

For more information, see “SmartKey” (▷ page 100).

Locking with KEYLESS-GO*

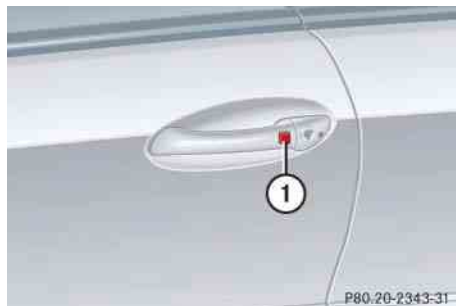

① Lock button

- ▶ Press lock button ① on an outside door handle.

With the trunk and both doors closed:

- All turn signal lamps flash three times.
- An acoustic signal sounds three times.
For more information, see “Factory setting” (▷ page 106).
- The locking knobs in the doors move down.
- The anti-theft alarm system is armed.

For more information, see “SmartKey with KEYLESS-GO*” (▷ page 103).

Occupant safety

Panic alarm

Driving safety systems

Anti-theft systems



Occupant safety

In this section you will learn the most important facts about the restraint system components of the vehicle.

- Seat belts (▷ page 77)
- Child restraints (▷ page 86)
- Lower Anchors and Tethers for Children (LATCH) (▷ page 87)

Additional protection potential is provided by:

- Supplemental Restraint System (SRS) with
 - Air bags (▷ page 65)
 - Air bag control unit (with crash sensors)
 - Emergency tensioning device (ETD) for seat belts (▷ page 80)
- Active head restraints (▷ page 81)
- CLK cabriolet: Roll bars (▷ page 82)

Air bag system components with

- Front passenger front air bag off indicator lamp (▷ page 76)
- Front passenger seat with Occupant Classification System (OCS) (▷ page 72)

Although the systems are independent, their protective functions work in conjunction with each other.

i *For information on infants and children traveling with you in the vehicle and restraint systems for infants and children, see “Children in the vehicle” (▷ page 83).*

The SRS system conducts a self-test when the ignition is switched on and in regular intervals while the engine is running. This facilitates detection of system malfunctions. The **SRS** indicator lamp in the instrument cluster comes on when the ignition is switched on and goes out no later than a few seconds after the engine has been started.

The SRS components are in operational readiness if the **SRS** indicator lamp is not lit when the engine is running.

A malfunction in the system has been detected if the **SRS** indicator lamp:

- fails to go out after approximately 4 seconds after the engine was started
- does not come on at all
- comes on after the engine was started or while driving

Air bags

Warning!



Modifications to or work improperly conducted on restraint systems (such as seat belts and anchors, emergency tensioning devices, seat belt force limiters or air bags) or their wiring, as well as tampering with interconnected electronic systems, can lead to the restraint systems no longer functioning as intended.

Air bags or emergency tensioning devices, for example, could deploy inadvertently or fail to deploy in accidents although the deceleration threshold for air bag deployment is exceeded. Therefore, never modify the restraint systems. Do not tamper with electronic components or their software.

Warning!



In the event that the **SRS** indicator lamp comes on during driving or does not come on at all, the SRS self-check has detected a malfunction. For your safety, we strongly

recommend that you visit an authorized Mercedes-Benz Center immediately to have the system checked; otherwise the SRS may not deploy when needed in an accident, which could result in serious or fatal injury, or it might deploy unexpectedly and unnecessarily which could also result in injury.

In addition, improper repair work on the SRS creates a risk of rendering the SRS inoperative or causing unintended air bag deployment. Work on the SRS must therefore only be performed by qualified technicians. Contact an authorized Mercedes-Benz Center.

If it is necessary to modify an air bag system to accommodate a person with disabilities, contact your local authorized Mercedes-Benz Center or call our Customer Assistance Center at 1-800-FOR-MERCEdes (1-800-367-6372) for details.

Warning!



Air bags are designed to reduce the potential of injury and fatality in certain frontal impacts (front air bags) or side impacts (CLK coupe: front side impact air bags, rear side impact air bags*, and window curtain air bags. CLK cabriolet: head-thorax air bags and rear side impact air bags*). However, no system available today can completely eliminate injuries and fatalities.

The deployment of the air bags temporarily releases a small amount of dust from the air bags. This dust, however, is neither injurious to your health, nor does it indicate a fire in the vehicle. The dust might cause some temporary breathing difficulty for people with asthma or other breathing trouble. To avoid this, you may wish to get out of the vehicle as soon as it is safe to do so. If you have any breathing difficulty but cannot get out of the vehicle after the air bag inflates, then get fresh air by opening a window or door.

Occupant safety

Warning!



To reduce the risk of injury when the front air bags inflate, it is very important for the driver and front passenger to always be in a properly seated position and to wear their respective seat belts.

For maximum protection in the event of a collision always be in normal seated position with your back against the backrest. Fasten your seat belt and make sure it is properly positioned on your body.

Since the air bag inflates with considerable speed and force, a proper seating and hands on steering wheel position will help to keep you at a safe distance from the air bag. Occupants who are unbelted, out of position or too close to the air bag can be seriously injured or killed by an air bag as it inflates with great force in the blink of an eye:

- Sit properly belted in a position that is as upright as possible with your back against the seat backrest.

- Adjust the driver's seat as far as possible rearward, still permitting proper operation of vehicle controls. The distance from the center of the driver's breastbone to the center of the air bag cover on the steering wheel must be at least 10 in (25 cm) or more. You should be able to accomplish this by a combination of adjustments to the seat and steering wheel. If you have any problems, please see an authorized Mercedes-Benz Center.
- Do not lean your head or chest close to the steering wheel or dashboard.
- Keep hands on the outside of steering wheel rim. Placing hands and arms inside the rim can increase the risk and potential severity of hand/arm injury when driver's front air bag inflates.
- Adjust the front passenger seat as far as possible rearward from the dashboard when the seat is occupied.

- Occupants, especially children, should always sit as upright as possible, properly use the seat belts and use an appropriately sized infant restraint, toddler restraint, or booster seat recommended for the size and weight of the child.

Failure to follow these instructions can result in severe injuries to you or other occupants.

If you sell your vehicle, it is important that you make the buyer aware of this safety information. Be sure to give the buyer this Operator's Manual.

Warning!

CLK coupe:

Accident research shows that the safest place for children in an automobile is in the rear seat.

There is a possibility for a side impact air bag related injury if occupants, especially children, are not properly seated or restrained when next to a front side impact air bag and/or rear side impact air bag* which needs to deploy rapidly in a side impact in order to do its job.

To help avoid the possibility of injury, please follow these guidelines:

- (1) Occupants, especially children, should never place their bodies or lean their heads in the area of the door or the rear side trim panel where the front side impact air bag and/or the rear side impact air bag* inflates.

This could result in serious injuries or death should the front side impact air bag and/or the rear side impact air bag* be deployed.

- (2) Always sit as upright as possible, properly use the seat belts and for children 12 years old and under, use an appropriately sized infant restraint, toddler restraint, or booster seat recommended for the size and weight of the child.
- (3) Always wear seat belts properly.

If you believe that, even with the use of these guidelines, it would be safer for your rear seat occupants to have the rear mounted side impact air bags* deactivated, then deactivation can be accomplished upon your written request to do so at an authorized Mercedes-Benz Center at an additional cost.

Please contact your local authorized Mercedes-Benz Center or call our Customer Assistance Center at 1-800-FOR-MERCEdes (1-800-367-6372) for details.

Warning!

CLK cabriolet:

Accident research shows that the safest place for children in an automobile is in the rear seat.

There is a possibility for a head-thorax air bag or rear side impact air bag* related injury if occupants, especially children, are not properly seated or restrained when next to a head-thorax air bag and/or rear side impact air bag* which needs to deploy rapidly in a side impact in order to do its job.

To help avoid the possibility of injury, please follow these guidelines:

- (1) Always sit as upright as possible, properly use the seat belts and for children 12 years old and under, use an appropriately sized infant restraint, toddler restraint or booster seat recommended for the size and weight of the child.
- (2) Always wear seat belts properly.

Occupant safety

i Air bags are designed to deploy only in certain frontal impacts (front air bags) and in side impacts (CLK coupe: front side impact air bags, rear side impact air bags*, and window curtain air bags. CLK cabriolet: head-thorax air bags and rear side impact air bags*) which exceed preset thresholds. Only during these events will they provide their supplemental protection.

The driver and passenger should always wear their seat belts. Otherwise it is not possible for the air bags to provide their supplemental protection.

In case of other types of impacts and impacts below air bag deployment thresholds, air bags will not deploy. The driver and passenger will then be protected to the extent possible by a properly fastened seat belt. A properly fastened seat belt is also needed to provide the best possible protection in a rollover.

We caution you not to rely on the presence of the air bags in order to avoid wearing your seat belt.

It is important to your safety and that of your passengers that you replace deployed air bags and repair any malfunctioning air bags to make sure the vehicle will continue to provide supplemental crash protection for occupants.

Safety guidelines for the seat belt, emergency tensioning device and air bag

Warning!



- Damaged seat belts or belts that were highly stressed in an accident must be replaced and their anchoring points must also be checked. Only use belts installed or supplied at an authorized Mercedes-Benz Center.
 - Air bags and Emergency Tensioning Devices (ETDs) contain Perchlorate material, which may require special handling and regard for the environment. Check with your local government's disposal guidelines. California residents, see <http://www.dtsc.ca.gov/HazardousWaste/Perchlorate/index.cfm>.
 - Air bags and emergency tensioning devices (ETDs) are designed to function on a one-time-only basis. An air bag or ETD that is deployed must be replaced.
 - Do not pass belts over sharp edges. They could tear.
- Do not make any modification that could change the effectiveness of the belts.
 - Do not bleach or dye seat belts as this may severely weaken them. In a crash they may not be able to provide adequate protection.
 - No modifications of any kind may be made to any components or wiring of the SRS. This includes changing or removing any component or part of the SRS, the installation of additional trim material, badges, seat covers (CLK cabriolet) etc. over the steering wheel hub, front passenger front air bag cover, outboard sides of the front seat backrest (CLK cabriolet), door trim panels (CLK coupe), door frame trims (CLK coupe), or rear side trim panels, and installation of additional electrical/electronic equipment on or near SRS components and wiring. Keep area between air bags and occupants free from objects (e.g. packages, purses, umbrellas, etc.).

- CLK coupe: Do not hang items such as coat hangers from the coat hooks or handles over the door. These items may turn into projectiles and cause head and other injuries when the window curtain air bag is deployed.
 - Air bag system components will be hot after an air bag has inflated. Do not touch.
 - Never place your feet on the instrument panel, dashboard, or on the seat. Always keep both feet on the floor in front of the seat.
 - In addition, improper repair work on the SRS creates a risk of rendering the SRS inoperative or causing unintended air bag deployment. Work on the SRS must therefore only be performed by qualified technicians. Contact an authorized Mercedes-Benz Center.
- For your protection and the protection of others, when scrapping the air bag unit or emergency tensioning device, our safety instructions must be followed. These instructions are available from any authorized Mercedes-Benz Center.
 - Given the considerable deployment speed, required inflation volume, and the textile structure of the air bags, there is the possibility of abrasions or other, potentially more serious injuries resulting from air bag deployment.

Warning!

CLK cabriolet: Only use seat covers which have been tested and approved by Mercedes-Benz for your vehicle model. Using other seat covers may interfere with or prevent the deployment of the head-thorax air bags. Contact your authorized Mercedes-Benz Center for availability.

When you sell your vehicle, we strongly urge you to give notice to the subsequent owner that it is equipped with an SRS by alerting them to the applicable section in the Operator's Manual.

Occupant safety

Front air bags



- ① Driver air bag
- ② Passenger air bag

Driver and front passenger front air bags are deployed:

- in the event of certain frontal impacts
- if impact exceeds a preset deployment threshold
- independently of the front side impact air bag (CLK coupe), head-thorax air bag (CLK cabriolet) and/or the rear side impact air bag*

i The front air bags in this vehicle have been designed to inflate in two stages. This allows the air bag to have different rates of inflation that are based on the rate of relevant vehicle deceleration as assessed by the air bag control unit.

On the front passenger side, the front air bag deployment is additionally influenced by the passenger's weight category as identified by the Occupant Classification System (OCS) (▷ page 72).

The lighter the front passenger side occupant, the higher the vehicle deceleration rate required for the second stage inflation of the air bag.

The air bags will not deploy in impacts which do not exceed the system's deployment thresholds. You will then be protected by the fastened seat belts.

The front passenger front air bag will only be deployed if:

- the system, based on OCS weight sensor readings, senses that the front passenger seat is occupied

- the  indicator lamp in the center console is not lit (▷ page 76)
- the impact exceeds a preset deployment threshold

CLK coupe:

Front side impact air bags*, rear side impact air bags*, window curtain air bags

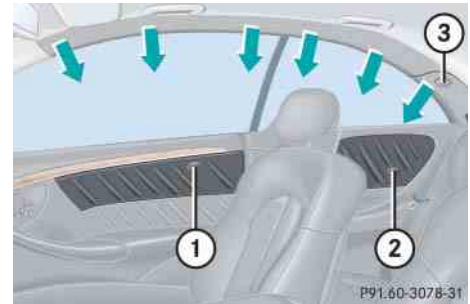

- ① Front side impact air bag
- ② Rear side impact air bag*
- ③ Window curtain air bag

The front side impact air bags, the rear side impact air bags*, and the window curtain air bags are deployed:

- on the impacted side of the vehicle
- in side impacts exceeding a preset deployment threshold
- independently of the front air bags

The front side impact air bags, the rear side impact air bags*, and the window curtain air bags are not deployed in impacts which do not exceed the system's deployment threshold.

CLK cabriolet: Head-thorax air bags

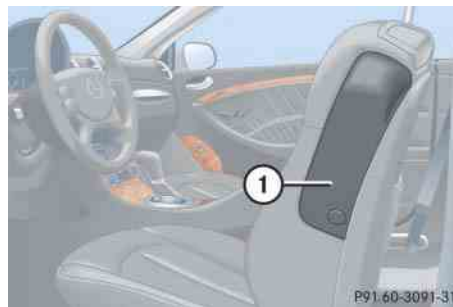

① Head-thorax air bag

The head-thorax air bags ① in the drivers and front passenger seat are deployed:

- on the impacted side of the vehicle
- in side impacts exceeding a preset deployment threshold
- independently of the front air bags

The head-thorax air bags ① are not deployed in impacts which do not exceed the system's deployment threshold.

Warning!



Only use seat covers which have been tested and approved by Mercedes-Benz for your vehicle model. Using other seat covers may interfere with or prevent the deployment of the head-thorax air bags. Contact your authorized Mercedes-Benz Center for availability.

Occupant safety

CLK cabriolet: Rear side impact air bags*

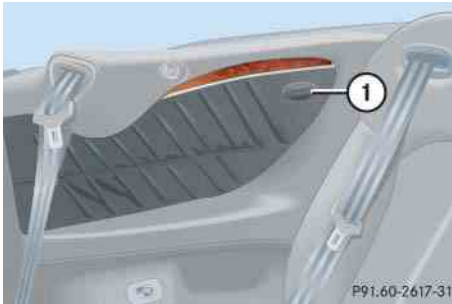

① Rear side impact air bag*

The rear side impact air bags* ① are deployed:

- on the impacted side of the vehicle
- in side impacts exceeding a preset deployment threshold
- independently of the front air bags

The rear side impact air bags* ① are not deployed in impacts which do not exceed the system's deployment threshold.

Occupant Classification System

The Occupant Classification System (OCS) automatically turns the front passenger front air bag on or off based on the classified occupant weight category determined by weight sensor readings from the front passenger seat.

i *CLK coupe: The system does not deactivate the front passenger side impact air bag, the window curtain air bag and the emergency tensioning device.*

CLK cabriolet: The system does not deactivate the head-thorax air bag and the emergency tensioning device.



Occupants must sit properly belted in a position that is as upright as possible with their back against the seat backrest and feet on the floor to be correctly classified. If the occupant's weight is transferred to another object in the vehicle (e.g. by leaning on armrests), the OCS may not be able to properly approximate the occupant's weight category.

i *If your seat, including your trim cover and cushion needs to be serviced in any way, take the vehicle to an authorized Mercedes-Benz Center.*

Only seat accessories approved by Mercedes-Benz may be used.

Both driver and the front passenger should always use the  indicator lamp as an indication of whether or not the front passenger is properly positioned.

Warning!

If the  indicator lamp illuminates when an adult or someone larger than a small individual is in the front passenger seat, have the front passenger re-position himself or herself in the seat until the  indicator lamp goes out.



More information about air bag display messages (▷ page 396).

In the event of a collision, the air bag control unit will not allow front passenger front air bag deployment when the OCS classified the front passenger seat occupant as being up to or less than the weight of a typical 12-month-old child in a standard child restraint or if the front passenger seat is sensed as being empty.

When the OCS senses that the front passenger seat occupant is classified as being up to or less than the weight of a typical 12-month-old child in a standard child restraint, the  indicator lamp will illuminate when the engine is started and remain illuminated, indicating that the front passenger front air bag is deactivated.

When the OCS senses that the front passenger seat is classified as being empty, the  indicator lamp will illuminate when the engine is started and remain illuminated, indicating that the front passenger front air bag is deactivated.

When the OCS senses that the front passenger seat occupant is classified as being heavier than the weight of a typical 12-month-old child seated in a standard child restraint or as being a small individual (such as a young teenager or a small adult),

the  indicator lamp will illuminate for approximately 6 seconds when the engine is started and then, depending on occupant weight sensor readings from the seat, remain illuminated or go out. With the  indicator lamp illuminated, the front passenger front air bag is deactivated. With the  indicator lamp out, the front passenger front air bag is activated.

When the OCS senses that the front passenger seat occupant is classified as an adult or someone larger than a small individual, the  indicator lamp will illuminate for approximately 6 seconds when the engine is started and then go out, indicating that the front passenger front air bag is activated.

If the  indicator lamp is illuminated, the front passenger front air bag is deactivated and will not be deployed. ▷▷

Occupant safety



If the  indicator lamp is not illuminated, the front passenger front air bag is activated and will be deployed:

- in the event of certain frontal impacts
- if impact exceeds a preset deployment threshold
- independently of the front side impact air bags (CLK coupe), head-thorax air bag (CLK cabriolet) and/or rear side impact air bags*.

If the front passenger front air bag is deployed, the rate of inflation will be influenced by:

- the rate of vehicle deceleration as assessed by the air bag control unit
- front passenger's weight category as identified by the Occupant Classification System (OCS).

Warning!







According to accident statistics, children are safer when properly restrained in the rear seating positions than in the front seating position. Thus, we strongly recommend that children be placed in the rear seats whenever possible. Regardless of seating position, children 12 years old and under must be seated and properly secured in an appropriate infant or child restraint recommended for the size and weight of the child.

The infant or child restraint must be properly secured with the vehicle's seat belt, the seat belt and top tether strap (CLK coupe), or lower anchors and top tether strap (CLK coupe), or seat belt and lower anchors (CLK cabriolet), fully in accordance with the child seat manufacturer's instructions.

Children can be killed or seriously injured by an inflating air bag. Note the following important information when circumstances require you to place a child in the front passenger seat:

- Your vehicle is equipped with air bag technology designed to turn off the front passenger front air bag in your vehicle when the system senses the weight of a typical 12-month-old child or less along with the weight of a standard appropriate child restraint on the front passenger seat.
- A child in a rear-facing child restraint on the front passenger seat will be seriously injured or even killed if the front passenger front air bag inflates in a collision which could occur under some circumstances, even with the air bag technology installed in your vehicle. The only means to completely eliminate this risk is to never place a child in a rear-facing child restraint in the front seat. We therefore strongly recommend that you always place a child in a rear-facing child restraint in the back seat.

- If you must install a rear-facing child restraint on the front passenger seat because circumstances require you to do so, make sure the  indicator lamp is illuminated, indicating that the front passenger front air bag is deactivated. Should the  indicator lamp not illuminate or go out while the restraint is installed, please check installation. Periodically check the  indicator lamp while driving to make sure the  indicator lamp is illuminated.

If the  indicator lamp goes out or remains out, do not transport a child on the front passenger seat until the system has been repaired. A child in a rear-facing child restraint on the front passenger seat will be seriously injured or even killed if the front passenger front air bag inflates.



- If you have to place a child in a forward-facing child restraint on the front passenger seat, move the seat as far back as possible, use the proper child restraint recommended for the age, size and weight of the child, and secure child restraint with the vehicle's seat belt according to the child seat manufacturer's instructions. For children larger than the typical 12-month-old child, the front passenger front air bag may or may not be activated (▷ page 73).

 *Deployment of the driver front air bag does not mean that the front passenger front air bag also should have deployed.*

The Occupant Classification System (▷ page 72) may have determined:



- *that the seat was empty or occupied by the weight up to or less than that of a typical 12-month-old child seated in a standard child restraint – both instances where the system suppresses deployment of the front passenger front air bag even though the impact met the criteria and was of sufficient severity to deploy the driver front air bag.*
- *that the seat was occupied by a small individual (such as a young teenager or a small adult) or a child weighing more than the weight of a typical 12-month-old child in a standard child restraint – instances where the system may suppress deployment of the front passenger front air bag even though the impact met the criteria and was of sufficient severity to deploy the driver front air bag.*

Occupant safety

The   indicator lamp is located in the center console.





① Front passenger front air bag off indicator lamp

The   indicator lamp ① will be illuminated, except with the SmartKey removed from the starter switch or with the starter switch in position 0.

Warning!



If the  indicator lamp and the   indicator lamp are lit at the same time, there is a malfunction in the Occupant Classification System. The front passenger front air bag will be deactivated in this case.

Have the system checked as soon as possible by qualified technicians. Contact an authorized Mercedes-Benz Center.





Only have the seat repaired or replaced at an authorized Mercedes-Benz Center.



In order to ensure proper operation of the air bag system and OCS:

- Sit properly belted in a position that is as upright as possible with your back against the seat backrest.
- While seated, an occupant should not position him/herself in such a way as to cause the occupant's weight to be lifted from the seat bottom as this may result in the OCS being unable to correctly approximate the occupant's weight category.

- Read and observe all warnings in this chapter.

Self-test Occupant Classification System

After turning the SmartKey in the starter switch to position 1 or 2 or pressing the KEYLESS-GO* start/stop button once or twice, the   indicator lamp located in the center console illuminates. If an adult occupant is properly sitting on the front passenger seat and the system senses the occupant as being an adult, the   indicator lamp will illuminate and go out after approximately 6 seconds.

If the seat is not occupied and the system senses the front passenger seat as being empty, the   indicator lamp will illuminate and not go out.

Warning!

If the  indicator lamp should not illuminate, the system is not functioning. You must see an authorized Mercedes-Benz Center before seating any child on the front passenger seat.

More information can be found in the “Practical hints” section (▷ page 390).

Warning!

Never place anything between seat cushion and child seat (e.g. pillow), since it reduces the effectiveness of the Occupant Classification System. The bottom of the child seat must make full contact with the passenger seat cushion. An incorrectly mounted child seat could cause injuries to the child in case of an accident, instead of increasing protection for the child.

Follow the manufacturer’s instructions for installation of child seats.

Seat belts

The use of seat belts and infant and child restraint systems is required by law in all 50 states, the District of Columbia, the U.S. territories and all Canadian provinces.

Even where this is not the case, all vehicle occupants should have their seat belts fastened whenever the vehicle is in motion.

For more information, see “Fastening the seat belts” (▷ page 48).

 For information on infants and children traveling with you in the vehicle and restraint systems for infants and children, see “Children in the vehicle” (▷ page 83).

Warning!

Always fasten your seat belt before driving off. Always make sure all of your passengers are properly restrained, including those sitting in the rear.

Failure to wear and properly fasten and position your seat belt greatly increases your risk of injuries and their likely severity in an accident. You and your passengers should always wear seat belts.

If you are ever in an accident, your injuries can be considerably more severe without your seat belt properly buckled. Without your seat belt buckled, you are much more likely to hit the interior of the vehicle or be ejected from it. You can be seriously injured or killed.

In the same crash, the possibility of injury or death is lessened if you are properly wearing your seat belt. Air bags can only protect as they are designed if the occupants are properly wearing their seat belts.

Occupant safety

Warning!



Never ride in a moving vehicle with the seat backrest in an excessively reclined position as this can be dangerous. You could slide under the seat belt in a collision. If you slide under it, the belt would apply force at the abdomen or neck. That could cause serious or even fatal injuries. The seat backrest and seat belt provide the best restraint when the wearer is in a position that is as upright as possible and the belt is properly positioned on the body.

Warning!



Never let more people ride in the vehicle than there are seat belts available. Make sure everyone riding in the vehicle is correctly restrained with a separate seat belt. Never use a seat belt for more than one person at a time.

Warning!



Damaged seat belts or seat belts that were highly stressed in an accident must be replaced and their anchoring points must also be checked.

Only use seat belts which have been approved by Mercedes-Benz.

Do not make any modifications to the seat belts. This can lead to unintended activation of the ETDs or to their failure to activate when necessary.

Do not bleach or dye seat belts as this may severely weaken them. In a crash they may not be able to provide adequate protection.

Have all work carried out only by qualified technicians. Contact an authorized Mercedes-Benz Center.

Warning!



USE SEAT BELTS PROPERLY

- Seat belts can only work when used properly. Never wear seat belts in any other way than as described in this section, as that could result in serious injuries in case of an accident.
- Each occupant should wear their seat belt at all times, because seat belts help reduce the likelihood of and potential severity of injuries in accidents, including rollovers. The integrated restraint system includes SRS (driver air bag, passenger front air bag, CLK coupe: front side impact air bags*, and window curtain air bags, CLK cabriolet: head-thorax air bags and rear side impact air bags*), ETD (seat belt emergency tensioning device), and front seat knee bolsters. The system is designed to enhance the protection offered to properly belted occupants in certain frontal (front air bags and ETD)

and side (CLK coupe: front side impact air bags, rear side impact air bags*, and window curtain air bags. CLK cabriolet: head-thorax air bags and rear side impact air bags* and ETD) impacts which exceed preset deployment thresholds.

- Never wear the shoulder belt under your arm, against your neck or off your shoulder. In a frontal crash, your body would move too far forward. That would increase the chance of head and neck injuries. The belt would also apply too much force to the ribs or abdomen, which could severely injure internal organs such as your liver or spleen.
- Never wear belts over rigid or breakable objects in or on your clothing, such as eyeglasses, pens, keys, etc., as these might cause injuries.
- Position the lap belt as low as possible on your hips and not across the abdomen. If the belt is positioned across your abdomen, it could cause serious injuries in a crash.



- Never use a seat belt for more than one person at a time. Do not fasten a seat belt around a person and another person or other objects.
- Belts should not be worn twisted. In a crash, you wouldn't have the full width of the belt to distribute impact forces. The twisted belt against your body could cause injuries.
- Pregnant women should also always use a lap-shoulder belt. The lap belt portion should be positioned as low as possible on the hips to avoid any possible pressure on the abdomen.
- Never place your feet on the instrument panel, dashboard, or on the seat. Always keep both feet on the floor in front of the seat.
- When using a seat belt to secure infant restraints, toddler restraints or children in booster seats, always follow the child seat manufacturer's instructions.

Enhanced seat belt reminder system

When the engine is started, the seat belt telltale  will always illuminate for 6 seconds to remind you and your passengers to fasten your seat belts.

If the driver's seat belt is not fastened when the engine is started, an additional warning chime will also sound for a maximum of 6 seconds or until the driver's seat belt is fastened.

If after these 6 seconds the driver's or the front passenger's seat belt (with the front passenger seat occupied) is not fastened with both doors closed,

- the seat belt telltale  remains illuminated for as long as either the driver's or front passenger's seat belt is not fastened.
- and if the vehicle speed once exceeds 15 mph (25 km/h), the seat belt telltale  starts flashing and a warning chime sounds with increasing

Occupant safety

intensity for a maximum of 60 seconds or until the driver's and the front passenger's seat belt are fastened.

If you and/or your passenger release the seat belt during driving, the seat belt telltale  starts flashing and a warning chime sounds as described before.

If the driver's or the front passenger's seat belt remains unfastened after 60 seconds, the warning chime stops sounding, the seat belt telltale  stops flashing but continues to be illuminated.

After a vehicle standstill, the warning chime is reactivated and the seat belt telltale  is flashing again if the vehicle speed once exceeds 15 mph (25 km/h).

The seat belt telltale  will only go out if both the driver's and the front passenger's seat belt (with the front passenger seat occupied) are fastened, or the vehicle is standing still and a door is opened.

For more information, see "Practical hints" (▷ page 385).

Emergency tensioning device (ETD), seat belt force limiter

The seat belts are equipped with emergency tensioning devices and belt force limiters.

The ETD is designed to activate in the following cases:

- in frontal or rear-end impacts exceeding the system deployment threshold
- if the restraint systems are operational and functioning correctly, see  indicator lamp (▷ page 64)

 *The ETDs for the front seats will only activate if the front seat belts are fastened (latch plate properly inserted into buckle).*

The ETDs for the rear seats will activate with or without the respective seat belts fastened.

When activated, emergency tensioning devices remove slack from the belts. Belt force limiters reduce the force exerted by the seat belts on occupants during a crash.

Warning!



An emergency tensioning device (ETD) that was activated must be replaced.

When disposing of the emergency tensioning device, our safety instructions must be followed. These are available at any authorized Mercedes-Benz Center.

Automatic comfort-fit feature seat belt

An automatic comfort-fit feature for front seats reduces the retracting force of the seat belts when they are in normal use.

Active head restraints

The active front seat head restraints are intended to offer the driver and front passenger increased protection from whiplash type injuries in rear-end collisions. In the event of a rear-end collision exceeding the systems' deployment threshold, the active head restraints on the driver's and front passenger's seats are designed to move forward in the direction of travel, providing the head with increased support earlier on in the collision sequence. The active head restraints activate whether the seat is occupied or not.

Warning!



For your protection, drive only with properly positioned head restraints.

Adjust the head restraint so that it is as close to the head as possible and the center of the head restraint supports the back of the head at eye level. This will reduce the

potential for injury to the head and neck in the event of an accident or similar situation.

Do not drive the vehicle without the seat head restraints. Head restraints are intended to help reduce injuries during an accident.

Warning!



Only use seat or head restraint covers which have been tested and approved by Mercedes-Benz for your vehicle model. Using other seat or head restraint covers may interfere with or prevent the activation of the active head restraints. Contact an authorized Mercedes-Benz Center for availability.

Do not attach any objects (e.g. hangers) to the head restraint posts. Otherwise, the active head restraints may not be able to function properly or offer the intended degree of protection in the event of an accident.

You cannot remove the active head restraint on the driver's and front passenger's seat.

For removal of the active head restraints we recommend that you contact an authorized Mercedes-Benz Center.

For information on head restraint adjustment, see "Seats" (▷ page 41).

For information on resetting the activated active head restraints, see "Resetting activated head restraints" (▷ page 440).

Occupant safety

Roll bars (CLK cabriolet)

Warning!



Make sure nothing is blocking the roll bars' path of motion. Otherwise someone could be injured when the roll bars are raised. The head restraints should therefore always be in the raised position when the rear seat is occupied (▷ page 123).

The roll bars are integrated into the rear head restraints.

The roll bars raise automatically in an accident or in a critical driving situation.

i When the roll bars are raised automatically, you will hear a ratcheting sound and the rear head restraints will also rise.

You can manually lower the roll bars again when the soft top is open (▷ page 431). With the soft top closed, contact an authorized Mercedes-Benz Center to have the roll bars lowered. Do not attempt to lower the roll bars manually with the soft top closed. Lowering the roll bars manually with the soft top closed may impair the function of the roll bars.

i You cannot lower the rear head restraints with the rear head restraint lowering switch (▷ page 123) when the roll bars are in the raised position.

Also, you cannot operate the soft top using the soft top switch when the roll bars are in the raised position.

- If the soft top is open, you can manually lower the roll bars (▷ page 431).

- If the soft top is closed, contact an authorized Mercedes-Benz Center to have the roll bars lowered.

Warning!



If the yellow roll bar warning lamp  in the clock does not go out after starting the engine, or if it comes on while driving, then the roll bar system is not operating properly and may not activate in an accident. In this case, raise the roll bars manually before continuing to drive (▷ page 430).

For safety reasons, drive only with the roll bars raised until the malfunction is repaired. Have your vehicle checked at an authorized Mercedes-Benz Center.

Children in the vehicle

If an infant or child is traveling with you in the vehicle:

- ▶ Secure the child using an infant or child restraint appropriate to the age and size of the child.
- ▶ Make sure the infant or child is properly secured at all times while the vehicle is in motion.

Warning!



Do not leave children unattended in the vehicle, even if they are secured in a child restraint system. The children could

- injure themselves on parts of the vehicle
- be seriously or fatally injured through excessive exposure to extreme heat or cold

If children open a door, they could

- injure other persons
- get out of the car and injure themselves or be injured by oncoming traffic

Do not expose the child restraint system to direct sunlight. The child restraint system's metal parts, for example, could become very hot, and the child could be burned on these parts.

Do not carry heavy or hard objects in the passenger compartment or trunk unless they are firmly secured in place. For more information, see “Loading” (▷ page 275), and see “Useful features” (▷ page 285) in the “Controls in detail” chapter.

Unsecured or improperly positioned cargo increases a child's risk of injury in the event of

- strong braking maneuvers
- sudden changes of direction
- an accident

Infant and child restraint systems

We recommend all infants and children be properly restrained at all times while the vehicle is in motion.

All lap-shoulder belts except the driver's seat belt have special seat belt retractors for secure fastening of child restraints.

To fasten a child restraint, follow child restraint instructions for mounting. Then pull the shoulder belt out completely and let it retract. During seat belt retraction, a ratcheting sound can be heard to indicate that the special seat belt retractor is activated. The belt is now locked. Push down on child restraint to take up any slack.

To deactivate, release seat belt buckle and let seat belt retract completely. The seat belt can again be used in the usual manner.

Warning!



Never release the seat belt buckle while the vehicle is in motion, since the special seat belt retractor will be deactivated.

Occupant safety

i For information on LATCH-type child seat anchors (▷ page 87).

CLK coupe: Information on child seats with anchor fittings for tether anchorages (▷ page 86).

The use of infant or child restraints is required by law in all 50 states, the District of Columbia, the U.S. territories, and all Canadian provinces.

Infants and small children should be seated in an appropriate infant or child restraint system properly secured in accordance with the manufacturer's instructions for the child restraint, that complies with U.S. Federal Motor Vehicle Safety Standards 213 and 225 and Canadian Motor Vehicle Safety Standards 213 and 210.2.

A statement by the child restraint manufacturer of compliance with these standards can be found on the instruction label on the restraint and in the instruction manual provided with the restraint.

When using any infant, or toddler restraint, or booster seat, be sure to carefully read and follow all manufacturer's instructions for installation and use.

Please read and observe warning labels affixed to the inside of the vehicle and to infant or child restraints.

Warning!



According to accident statistics, children are safer when properly restrained in the rear seating positions than in the front seating position. Thus, we strongly recommend that children be placed in the rear seats whenever possible. Regardless of seating position, children 12 years old and under must be seated and properly secured in an appropriate infant or child restraint recommended for the size and weight of the child.

The infant or child restraint must be properly secured with the vehicle's seat belt, or:

CLK coupe: the seat belt and top tether strap, or lower anchors and top tether strap,

CLK cabriolet: the seat belt and lower anchors,



fully in accordance with the child seat manufacturer's instructions.

Occupants, especially children, should never place their bodies or lean their heads in the area of the door or the rear side trim panel where the front side impact air bag (CLK cabriolet: head-thorax air bag) and/or the rear side impact air bag* inflates. This could result in serious injuries or death should the air bag be triggered. Always sit as upright as possible, properly use the seat belts and use an appropriately sized infant restraint, toddler restraint, or booster seat recommended for the size and weight of the child.

Children can be killed or seriously injured by an inflating air bag. Note the following important information when circumstances require you to place a child in the front passenger seat:

- Your vehicle is equipped with air bag technology designed to turn off the front passenger front air bag in your vehicle when the OCS senses the weight of a typical 12-month-old child or less along with the weight of a standard appropriate child restraint on the front passenger seat.
- A child in a rear-facing child restraint on the front passenger seat will be seriously injured or even killed if the front passenger front air bag inflates in a collision which could occur under some circumstances, even with the air bag technology installed in your vehicle. The only means to completely eliminate this risk is to never place a child in a rear-facing child restraint in the front seat. We therefore strongly recommend that you always place a child in a rear-facing child restraint in the back seat.
- If you must install a rear-facing child restraint on the front passenger seat because circumstances require you to do so, make sure the  indicator lamp is illuminated, indicating that

the front passenger front air bag is deactivated. Should the  indicator lamp not illuminate or go out while the restraint is installed, please check installation. Periodically check the

 indicator lamp while driving to make sure the  indicator lamp is illuminated. If the  indicator lamp goes out or remains out, do not transport a child on the front passenger seat until the system has been repaired. A child in a rear-facing child restraint on the front passenger seat will be seriously injured or even killed if the front passenger front air bag inflates.

- If you have to place a child in a forward-facing child restraint on the front passenger seat, move the seat as far back as possible, use the proper child restraint recommended for the age, size and weight of the child, and secure child restraint with the vehicle's seat belt according to the child seat manufacturer's instructions.

For children larger than the typical 12-month-old child, the front passenger front air bag may or may not be activated (▷ page 73).

Warning!



Infants and small children should never share a seat belt with another occupant. During an accident, they could be crushed between the occupant and seat belt.

A child's risk of serious or fatal injuries is significantly increased if the child restraints are not properly secured in the vehicle and/or the child is not properly secured in the child restraint.

Children too big for a toddler restraint must ride in seats using regular seat belts. Position shoulder belt across chest and shoulder, not face or neck. A booster seat may be necessary to achieve proper belt positioning for children over 41 lbs until they reach a height where a lap/shoulder belt fits properly without a booster.



Occupant safety



When the child restraint is not in use, remove it from the vehicle or secure it with the seat belt to prevent the child restraint from becoming a projectile in the event of an accident.

Do not leave children unattended in the vehicle, even if the children are secured in a child restraint system. Unsupervised children in a child restraint system may use vehicle equipment and may cause an accident and/or serious personal injury.

Installation of infant and child restraint systems

The CLK coupe is equipped with tether anchorages for a top tether strap at each of the rear seating positions.

i Your CLK cabriolet does not have and is not required to have anchorage rings for a child seat's top tether strap in the rear seating positions. Child seats can be used with the seat belt, or lower anchor system and seat belt, fully in accordance with the child seat manufacturer's instructions.

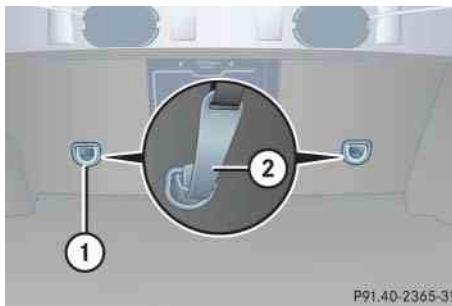

P91.40-2365-31

- ① Anchorage ring
- ② Hook

- ▶ Open the trunk and release the rear seat backrest (▶ page 281).
- ▶ Fold rear seat backrest slightly forward.
- ▶ Guide top tether strap between head restraint and top of seat back.

Head restraint must be installed and positioned such that the top tether strap can pass freely between the head restraint and the top of seat back.

Make sure the tether strap is not twisted.

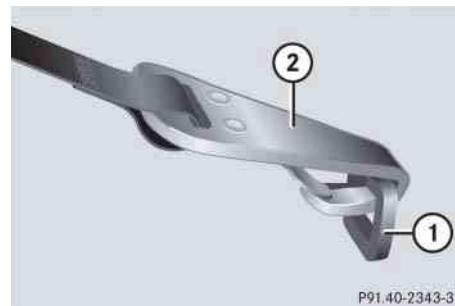

P91.40-2343-31

- ① Anchorage ring
- ② Hook

- ▶ Fold up anchorage ring ①.
- ▶ Securely fasten hook ②, which is part of the tether strap, to anchorage ring ①.

i For safety, make sure the hook ② has attached to the anchorage ring ① beyond the safety catch, as illustrated.

- ▶ Swing rear seat backrest to the rear until it engages.
- ▶ Check the rear seat backrest to be locked in its upright position (▶ page 282).

Warning!

Always lock backrest in its upright position when rear seat bench is occupied by passengers, or the extended cargo area is not in use. Check for secure locking by pushing and pulling on the backrest.

Once the top tether anchorage hook is attached, the child restraint itself can be secured. Secure the child restraint and tighten the top tether strap according to the child restraint manufacturer's instructions.

Child seat anchors – LATCH-type

The CLK coupe and cabriolet are equipped with two LATCH- (Lower Anchors and Tethers for Children) type anchors (at each of the rear seats) for the installation of a LATCH-type child seat with matching mounting fittings.

Warning!

Children too big for a toddler restraint must ride in seats using regular seat belts. Position shoulder belt across chest and shoulder, not face or neck.

A booster seat may be necessary to achieve proper belt positioning for children over 41 lbs until they reach a height where a lap/shoulder belt fits properly without a booster.

Install child seat according to manufacturer's instructions.

The child seat must be firmly attached to the right and left side anchor.

An incorrectly mounted child seat may come loose during an accident which could result in serious injury or death to the child.

Damaged or impact damaged child seats or child seat anchor fittings must be replaced.

Do not leave children unattended in the vehicle, even if the children are secured in a child restraint system.

i Non-LATCH-type child seats may also be used and can be installed using the vehicle's seat belt system (▷ page 83). Install child seat according to the manufacturer's instructions.

LATCH-type anchors

The LATCH-type anchors are located between the seat cushion and the backrest.

**① Anchors**

- ▶ Install child seat according to the manufacturer's instructions.

Occupant safety

Blocking of rear side window operation

You can block the rear side window operation (for instance when you have children riding in the rear passenger compartment).

The override switch is located on the door control panel of the driver's door.



- ① Deactivating override switch
- ② Activating override switch
- ③ Override switch

Warning!



Activate the override switch when children are riding in the back seats of the vehicle. The children may otherwise injure themselves, e.g. by becoming trapped in the window opening.

When leaving the vehicle, always remove the SmartKey or SmartKey with KEYLESS-GO* from the starter switch, take it with you, and lock the vehicle. Do not leave children unattended in the vehicle, or with access to an unlocked vehicle. A child's unsupervised access to a vehicle could result in an accident and/or serious personal injury.

Activating override switch

- ▶ Slide override switch ③ to the right in direction ②.

The rear side windows can no longer be operated using the respective switch located in the rear trim panels.

i Operation of the rear side windows with the switches located on the door control panel of the driver's door is still possible.

Deactivating override switch

- ▶ Slide override switch ③ to the left in direction ①.

The rear side windows can be operated using the respective switch located in the rear trim panels.

For more information, see "Power windows" (▷ page 250).

▼ Panic alarm



① **PANIC** button

i USA only:

This device complies with Part 15 of the FCC Rules. Operation is subject to the following two conditions:

- (1) This device may not cause harmful interference, and*
- (2) this device must accept any interference received, including interference that may cause undesired operation.*

Any unauthorized modification to this device could void the user's authority to operate the equipment.

i Canada only:

This device complies with RSS-210 of Industry Canada. Operation is subject to the following two conditions:

- (1) This device may not cause interference, and*
- (2) this device must accept any interference received, including interference that may cause undesired operation of the device.*

Any unauthorized modification to this device could void the user's authority to operate the equipment.

Activating

- ▶ Press and hold button **PANIC** for at least 1 second.

An audible alarm and flashing exterior lamps will operate briefly.

Deactivating

- ▶ Press button **PANIC** again.

or

- ▶ Insert the SmartKey or the SmartKey with KEYLESS-GO* in starter switch.

or

- ▶ Press the KEYLESS-GO* start/stop button (▷ page 39).

The SmartKey with KEYLESS-GO* must be inside the vehicle.

Driving safety systems

In this section you will find information on the following driving safety systems:

- ABS (Antilock Brake System)
- BAS (Brake Assist System)
- ESP® (Electronic Stability Program)

Warning!



The following factors increase the risk of accidents:

- Excessive speed, especially in turns
- Wet and slippery road surfaces
- Following another vehicle too closely

The ABS, BAS, and ESP® cannot reduce this risk.

Always adjust your driving style to the prevailing road and weather conditions.

i *In winter operation, the maximum effectiveness of the ABS, the BAS, and the ESP® is only achieved with winter tires (▷ page 362) or snow chains as required.*

ABS

Warning!



Do not pump the brake pedal. Use firm, steady brake pedal pressure instead. Pumping the brake pedal defeats the purpose of the ABS and significantly reduces braking effectiveness.

The Antilock Brake System (ABS) regulates the brake pressure so that the wheels do not lock during braking. This allows you to maintain the ability to steer your vehicle.

The ABS is functional above a speed of approximately 5 mph (8 km/h) independent of road surface conditions.

On slippery road surfaces, the ABS will respond even to light brake pressure.

The  indicator lamp in the instrument cluster (▷ page 28) comes on when you switch on the ignition. It goes out when the engine is running.

Braking

At the instant one of the wheels is about to lock up, a slight pulsation can be felt in the brake pedal, indicating that the ABS is in the regulating mode.

- ▶ Keep firm and steady pressure on the brake pedal while experiencing the pulsation.

Continuous, steady brake pedal pressure yields the advantages provided by the ABS, namely braking power and the ability to steer the vehicle.

The pulsating brake pedal can be an indication of hazardous road conditions and functions as a reminder to take extra care while driving.

Emergency brake maneuver

- ▶ Keep continuous full pressure on the brake pedal.

Warning!



When the ABS is malfunctioning, the BAS and the ESP[®] are also switched off. The basic driving and braking functions are still available.

When the ABS is malfunctioning, the wheels may lock during hard braking, reducing steering capability and extending the braking distance.

Warning!



The ABS cannot prevent the natural laws of physics from acting on the vehicle, nor can it increase braking or steering efficiency beyond that afforded by the condition of the vehicle brakes and tires or the traction available on the road surface. The ABS cannot prevent accidents, including those resulting from excessive speed in turns, following another vehicle too closely, or hydroplaning. Only a safe, attentive, and skillful driver can prevent accidents. The capabilities of an ABS equipped vehicle must never be exploited in a reckless or dangerous manner which could jeopardize the user's safety or the safety of others.

For more information, see "Practical hints" (▷ page 377).

Driving safety systems

BAS

The Brake Assist System (BAS) operates in emergency situations. If you apply the brakes very quickly, the BAS automatically provides full brake boost, thereby potentially reducing the braking distance.

- ▶ Apply continuous full braking pressure until the emergency braking situation is over.

The ABS will prevent the wheels from locking.

When you release the brake pedal, the brakes function again as normal. The BAS is then deactivated.

Warning!



If the BAS is malfunctioning, the brake system is still functioning normally, but without the additional brake boost available that BAS would normally provide in an emergency braking maneuver. Therefore, the braking distance may increase.

Warning!





The BAS cannot prevent the natural laws of physics from acting on the vehicle, nor can it increase braking efficiency beyond that afforded by the condition of the vehicle brakes and tires or the traction. The BAS cannot prevent accidents, including those resulting from excessive speed in turns, following another vehicle too closely, or hydroplaning. Only a safe, attentive, and skillful driver can prevent accidents. The capabilities of a BAS equipped vehicle must never be exploited in a reckless or dangerous manner which could jeopardize the user's safety or the safety of others.

ESP®

The Electronic Stability Program (ESP®) is operational as soon as the engine is running and monitors the vehicle's traction (force of adhesive friction between the tires and the road surface) and handling.

The ESP® recognizes when a wheel is spinning or if the vehicle starts to skid. By applying the brakes to the appropriate wheel and by limiting the engine output, the ESP® works to stabilize the vehicle. The ESP® is especially useful while driving off and on wet or slippery road surfaces. The ESP® also stabilizes the vehicle during braking and steering maneuvers.

The ESP® warning lamp  in the instrument cluster flashes when the ESP® is engaged.

The ESP® warning lamp  in the instrument cluster comes on when you switch on the ignition. It goes out when the engine is running.

Warning!

Never switch off the ESP® when you see the ESP® warning lamp  flashing in the instrument cluster. In this case, proceed as follows:

- While driving off, apply as little throttle as possible.
- While driving, ease up on the accelerator.
- Adapt your speed and driving style to the prevailing road conditions.

Failure to observe these guidelines could cause the vehicle to skid.

The ESP® cannot prevent accidents resulting from excessive speed.

Warning!

The ESP® cannot prevent the natural laws of physics from acting on the vehicle, nor can it increase the traction afforded by the existing road and tire conditions. The ESP® cannot prevent accidents, including those resulting from excessive speed in turns or hydroplaning. Only a safe, attentive, and skillful driver can prevent accidents. The capabilities of an ESP® equipped vehicle must never be exploited in a reckless or dangerous manner which could jeopardize the user's safety or the safety of others.

 The ESP® will only function properly if you use wheels of the recommended tire size (▷ page 482).

 Because the ESP® operates automatically, the engine and the ignition must be shut off (SmartKey in starter switch position **0** or **1** or KEYLESS-GO* start/stop button in position **0** or **1**) when

- the parking brake is being tested on a brake test dynamometer
- the vehicle is being towed with the front axle raised

Active braking action through the ESP® may otherwise seriously damage the brake system.

For more information, see the “Practical hints” section (▷ page 384) and (▷ page 394).

Driving safety systems

Electronic traction system

The electronic traction system is a component of ESP®.

The electronic traction system improves the vehicle's ability to utilize available traction, especially under slippery road conditions by applying the brakes to a spinning wheel.

When you switch off the ESP®, the electronic traction system is still enabled.

Warning!



If you are driving too fast, the electronic traction system cannot reduce the risk of an accident.

The electronic traction system cannot prevent the natural laws of physics from acting on the vehicle.

Switching off the ESP®

Switching off the ESP® (except CLK 63 AMG)

Warning!



The ESP® should not be switched off during normal driving other than in the circumstances described below. Disabling of the system will reduce vehicle stability in standard driving maneuvers.

Do not switch off the ESP® when a spare wheel is mounted.

To improve the vehicle's traction, switch off the ESP® in driving situations where it would be advantageous to have the drive wheels spin and thus cut into surfaces for better grip such as:

- when driving with snow chains
- in deep snow
- in sand or gravel

Warning!



Switch on the ESP® immediately if the aforementioned circumstances do not apply anymore. Otherwise the ESP® will not stabilize the vehicle when it is starting to skid or a wheel is spinning.

When you switch off the ESP®

- the ESP® does not stabilize the vehicle
- the engine output is not limited, which allows the drive wheels to spin and thus cut into surfaces for better grip
- the traction control will still apply the brakes to a spinning wheel
- the ESP® continues to operate when you are braking
- you cannot activate the cruise control
- the cruise control switch off if currently activated

i When the ESP® is switched off and one or more drive wheels are spinning, the ESP® warning lamp  in the instrument cluster flashes. However, the ESP® will then not stabilize the vehicle.

The ESP® switch is located on the center console.



① ESP® switch

- ▶ With the engine running, press ESP® switch ① until the ESP® warning lamp  in the instrument cluster comes on.

The ESP® is switched off.

Warning!



When the ESP® warning lamp  is illuminated continuously, the ESP® is switched off or is not operational due to a malfunction. Vehicle stability in standard driving maneuvers reduces.

Adapt your speed and driving to the prevailing road conditions and to the non-operating status of the ESP®.

! *Avoid spinning of a drive wheel for an extended period with the ESP® switched off. This may cause serious damage to the drivetrain which is not covered by the Mercedes-Benz Limited Warranty.*

Switching off the ESP® (CLK 63 AMG only)

Warning!



The ESP® should not be switched off during normal driving. Disabling of the system will result in the following:

- no restriction to engine torque
- loss of system supported traction control

“ESP® Off” is designed for driving on closed tracks when the natural oversteer and understeer characteristics are desired and requires a highly skilled and experienced driver able to handle these critical driving situations.

You could lose control of your vehicle and cause an accident.

Please be aware of these limits when you switch off the ESP®.

Driving safety systems

When you switch off the ESP®

- the ESP® does not stabilize the vehicle
- the engine output is not limited, which allows the drive wheels to spin and thus cut into surfaces for better grip
- the traction control will still apply the brakes to a spinning wheel
- the ESP® operates while you are braking
- you cannot activate the cruise control
- the cruise control switch off if currently activated

i When the ESP® is switched off and one or more drive wheels are spinning, the ESP® warning lamp  in the instrument cluster flashes. However, the ESP® will then not stabilize the vehicle.

The ESP® switch is located on the center console.



① ESP® switch

- ▶ With the engine running, press ESP® switch ① until the ESP® warning lamp  in the instrument cluster comes on.

The ESP® is switched off.

Warning!



When the ESP® warning lamp  is illuminated continuously, the ESP® is switched off or is not operational due to a malfunction. Vehicle stability in standard driving maneuvers reduces.

Adapt your speed and driving to the prevailing road conditions and to the non-operating status of the ESP®.

! Avoid spinning of a drive wheel for an extended period with the ESP® switched off. This may cause serious damage to the drivetrain which is not covered by the Mercedes-Benz Limited Warranty.

Switching on the ESP®

- ▶ Press ESP® switch ① until the ESP® warning lamp  in the instrument cluster goes out.

You are now again in normal driving mode with ESP® switched on.

▼ Anti-theft systems

Immobilizer

The immobilizer prevents unauthorized persons from starting your vehicle.

When leaving the vehicle, always take the SmartKey or SmartKey with KEYLESS-GO* with you and lock the vehicle. The engine can be started by anyone with a valid SmartKey or SmartKey with KEYLESS-GO* that is left inside the vehicle.

Activating

With the SmartKey

- ▶ Remove the SmartKey from the starter switch.

With KEYLESS-GO*

- ▶ Turn off the engine by means of the start/stop button (▷ page 39) on the gear selector lever.
- ▶ Open the driver's door.

Deactivating

With the SmartKey

- ▶ Insert the SmartKey in the starter switch.

With KEYLESS-GO*

- ▶ Switch on the ignition (▷ page 40).

i *Starting the engine will also deactivate the immobilizer.*

In case the engine cannot be started (yet the vehicle's battery is charged), the system is not operational. Contact an authorized Mercedes-Benz Center or call 1-800-FOR-MERCEdes (in the USA), or 1-800-387-0100 (in Canada).

Anti-theft alarm system

Once the alarm system has been armed, a visual and audible alarm is triggered when someone opens

- a door
- the trunk
- the hood

The alarm will stay on even if the activating element (e.g. a door) is immediately closed.

The alarm system will also be triggered when

- the vehicle is opened with the mechanical key.
- someone opens a door from the inside.
- someone opens the trunk with the emergency release button.

Anti-theft systems

i If the alarm stays on for more than 30 seconds, a call to the Response Center is initiated automatically by the Tele Aid system (▷ page 295) provided Tele Aid service was subscribed to and properly activated, and that necessary cellular service and GPS coverage are available.

Arming the alarm system

The indicator lamp is in the center console.



① Indicator lamp

- ▶ Lock the vehicle with the SmartKey or KEYLESS-GO*.

The turn signal lamps flash three times, and an acoustic signal sounds three times, to indicate that the alarm system is armed.

Indicator lamp ① begins to flash after approximately 30 seconds after arming the alarm system.

i If the turn signal lamps do not flash three times, and the acoustic signal do not sounds three times (if equipped and feature activated), one of the following elements may not be properly closed:

- a door
- the trunk

Close the respective element and lock the vehicle again.

Disarming the alarm system



- ▶ Unlock your vehicle with the SmartKey or KEYLESS-GO*.

The turn signal lamps flash once, and an acoustic signal sounds once, to indicate that the alarm system is disarmed.

i The alarm system will rearm automatically after approximately 40 seconds if neither a door nor the trunk lid was opened.

Canceling the alarm

With the SmartKey

- ▶ Press the  or  button on the SmartKey.

or

- ▶ Insert the SmartKey in the starter switch.

With KEYLESS-GO*

- ▶ Pull an outside door handle.

The SmartKey with KEYLESS-GO must be within 3 ft (1 m) of the vehicle.

or

- ▶ Press the KEYLESS-GO start/stop button (▷ page 39).

The SmartKey with KEYLESS-GO must be inside the vehicle.

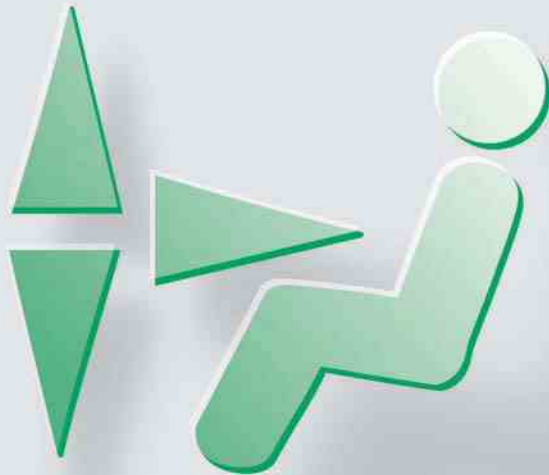

Locking and unlocking

Seats

Memory function

Lighting

Instrument cluster

Control system

Automatic transmission

Good visibility

Climate control

Automatic climate control

Audio system

Power windows

Power tilt/sliding sunroof* (Coupe)

Soft top (Cabriolet)

Driving systems

Loading

Useful features

Locking and unlocking

In the “Controls in detail” section you will find detailed information on how to operate the equipment installed in your vehicle. If you are already familiar with the basic functions of your vehicle, this section will be of particular interest to you.

To quickly familiarize yourself with the basic functions of the vehicle, refer to the “Getting started” section of this manual. The corresponding page numbers are given at the beginning of each segment.

For more information on locking and unlocking, see “Getting started” (▷ page 36) and (▷ page 59).

SmartKey

Your vehicle comes supplied with two SmartKeys, each with remote control and a removable mechanical key.



The SmartKey provides an extended operating range. To prevent theft, however, it is advisable to only unlock the vehicle when you are in close proximity to it.

The SmartKey centrally locks and unlocks:

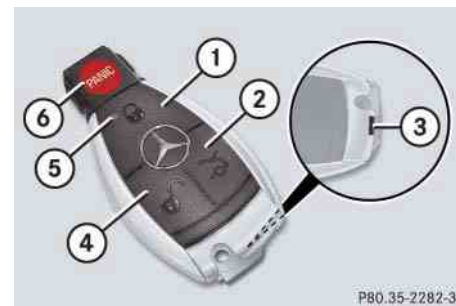
- the doors
- the trunk
- the fuel filler flap
- the glove box



SmartKey with remote control

- ①  Lock button
- ②  Opening button for trunk (▷ page 103)
- ③ Mechanical key locking tab
- ④  Unlock button
- ⑤ Battery check lamp
- ⑥ **PANIC** Panic button (▷ page 89)

! To prevent possible malfunction, avoid exposing the SmartKey to high levels of electromagnetic radiation.

Warning!

When leaving the vehicle, always remove the SmartKey from the starter switch, take it with you, and lock the vehicle. Do not leave children unattended in the vehicle, or with access to an unlocked vehicle. It is possible for children to open a locked door from the inside, which could result in an accident and/or serious personal injury.

Opening a door causes its windows to open slightly. It will fully close when the door is shut.

! A side window will not work if it is blocked with ice or if the battery needs charging. If you cannot shut a door, do not force it or you could damage the door or the side window. Fix whatever is affecting the window before trying to shut the door.

i USA only:
This device complies with Part 15 of the FCC Rules. Operation is subject to the following two conditions:

- (1) This device may not cause harmful interference, and
- (2) this device must accept any interference received, including interference that may cause undesired operation.

Any unauthorized modification to this device could void the user's authority to operate the equipment.

i Canada only:
This device complies with RSS-210 of Industry Canada. Operation is subject to the following two conditions:

- (1) This device may not cause interference, and
- (2) this device must accept any interference received, including interference that may cause undesired operation of the device.

Any unauthorized modification to this device could void the user's authority to operate the equipment.

i You can also open and close the windows (▷ page 253) and the tilt/sliding sunroof* (▷ page 257) or the soft top (▷ page 263) using the SmartKey.

! If you can no longer lock or unlock the vehicle with the SmartKey, then the batteries in the SmartKey are discharged, the SmartKey is malfunctioning or the vehicle battery is drained.

- Check the batteries in the SmartKey (▷ page 108) and replace them if necessary (▷ page 441).
- Use the mechanical key to unlock the driver's door (▷ page 427) and the trunk (▷ page 428).
- Use the mechanical key to lock the driver's door (▷ page 428) and the trunk (▷ page 118).
- Have the vehicle battery and the battery connections checked (▷ page 464).

If the SmartKey is malfunctioning, contact Roadside Assistance or an authorized Mercedes-Benz Center.

Locking and unlocking

Factory setting

i When unlocking or locking the vehicle with the SmartKey an acoustic signal sounds. The acoustic signal is activated at the factory. If you wish to deactivate the feature, or adjust its signal volume, contact an authorized Mercedes-Benz Center.

Global unlocking

- ▶ Press button .
- All turn signal lamps flash once.
- An acoustic signal sounds once.
- The locking knobs in the doors move up.
- The anti-theft alarm system is disarmed.

The vehicle will lock again automatically and rearm the anti-theft alarm system within approximately 40 seconds of unlocking if:

- neither door nor trunk is opened
- the SmartKey is not inserted in the starter switch

- the central locking switch is not activated

Global locking



- ▶ Press button .

With the trunk and both doors closed:

- All turn signal lamps flash three times.
- An acoustic signal sounds three times.
- The locking knobs in the doors move down.
- The anti-theft alarm system is armed.

Selective setting

If you frequently travel alone, you may wish to reprogram the SmartKey so that pressing button  only unlocks the driver's door and the fuel filler flap.

- ▶ Press and hold buttons  and  simultaneously for about 5 seconds until battery check lamp  (▷ page 100) flashes twice.

The SmartKey will then function as follows:

Unlocking driver's door and fuel filler flap

- ▶ Press button  once.
 - All turn signal lamps flash once.
 - An acoustic signal sounds once.
 - The locking knob in the driver's door move up.
 - The anti-theft alarm system is disarmed.

Global unlocking

- ▶ Press button  twice.
 - All turn signal lamps flash once.
 - An acoustic signal sounds once.

- The locking knobs in the doors move up.
- The anti-theft alarm system is disarmed.



Global locking

- ▶ Press button .

With the trunk and both doors closed:

- All turn signal lamps flash three times.
- An acoustic signal sounds three times.
- The locking knobs in the doors move down.
- The anti-theft alarm system is armed.

Restoring to factory setting

- ▶ Press and hold buttons  and  simultaneously for about 5 seconds until battery check lamp  (> page 100) flashes twice.

Unlocking and opening the trunk

You can unlock and open the trunk separately.

A minimum height clearance of 5.71 ft (1.74 m) CLK coupe or 5.41 ft (1.65 m) CLK cabriolet is required to open the trunk lid.

- ▶ Press and hold button  until trunk unlocks and begins to open.

 *The trunk lid swings open upwards automatically. Always make sure there is sufficient overhead clearance.*

Vehicles with trunk opening/closing system: To stop the opening procedure, press button . The trunk lid stops moving.*

 *If the trunk does not open, it is still locked separately (> page 118).*

The trunk can also be opened from its inside in an emergency, see “Trunk emergency release” (> page 117).

SmartKey with KEYLESS-GO*

Vehicles equipped with KEYLESS-GO come with two SmartKeys with KEYLESS-GO, each with remote control and a removable mechanical key.

The KEYLESS-GO function is integrated into the SmartKey. On these vehicles, the validity of the SmartKey with KEYLESS-GO is checked every time you pull an outside door handle.





If the SmartKey with KEYLESS-GO is valid, your vehicle unlocks

- the doors
- the trunk
- the fuel filler flap
- the glove box

Locking and unlocking



SmartKey with KEYLESS-GO

- ①  Lock button
- ②  Opening button for trunk
(▷ page 108)
- ③ Mechanical key locking tab
- ④  Unlock button
- ⑤ Battery check lamp
- ⑥  PANIC Panic button (▷ page 89)

! To prevent possible malfunction, avoid exposing the SmartKey with KEYLESS-GO to high levels of electromagnetic radiation.

Warning!



When leaving the vehicle, always take the SmartKey with KEYLESS-GO* with you, and lock the vehicle. Do not leave children unattended in the vehicle, or with access to an unlocked vehicle. A child's unsupervised access to a vehicle could result in an accident and/or serious personal injury.

Opening a door causes its windows to open slightly. It will fully close when the door is shut.

! A side window will not work if it is blocked with ice or if the battery needs charging. If you cannot shut a door, do not force it or you could damage the door or the side window. Fix whatever is affecting the window before trying to shut the door.

i USA only:

This device complies with Part 15 of the FCC Rules. Operation is subject to the following two conditions:

- (1) This device may not cause harmful interference, and
- (2) this device must accept any interference received, including interference that may cause undesired operation.

Any unauthorized modification to this device could void the user's authority to operate the equipment.

i Canada only:

This device complies with RSS-210 of Industry Canada. Operation is subject to the following two conditions:

- (1) This device may not cause interference, and
- (2) this device must accept any interference received, including interference that may cause undesired operation of the device.

Any unauthorized modification to this device could void the user's authority to operate the equipment.

i You can also open and close the windows (▷ page 250) and the tilt/sliding sunroof* (▷ page 257) or the soft top (▷ page 263) using the SmartKey with KEYLESS-GO.

! If you can no longer lock or unlock the vehicle with the SmartKey with KEYLESS-GO, then the batteries in the SmartKey with KEYLESS-GO are discharged, the SmartKey with KEYLESS-GO is malfunctioning or the vehicle battery is drained.

- Check the batteries in the SmartKey with KEYLESS-GO (▷ page 108) and replace them if necessary (▷ page 441).
- Use the mechanical key to unlock the driver's door (▷ page 427) and the trunk (▷ page 428).
- Use the mechanical key to lock the driver's door (▷ page 428) and the trunk (▷ page 118).
- Have the vehicle battery and the battery connections checked (▷ page 464).

If the SmartKey with KEYLESS-GO is malfunctioning, contact an authorized Mercedes-Benz Center.

Important notes on using KEYLESS-GO*

- You can also use the SmartKey with KEYLESS-GO like a normal SmartKey (▷ page 100).
- You can combine KEYLESS-GO functions with normal SmartKey functions (e.g. unlocking with KEYLESS-GO and locking with the  button).
- Always carry the SmartKey with KEYLESS-GO with you.
- Never store the SmartKey with KEYLESS-GO together with:
 - Electronic items such as a cellular phone or another SmartKey with KEYLESS-GO.
 - Metallic objects such as coins or metal foil.

Doing so could impair the function of the KEYLESS-GO system.

- To lock or unlock the vehicle, the SmartKey with KEYLESS-GO must be located outside the vehicle within approximately 3 ft (1 m) of the door to be opened or the trunk lid.
- In order to start the engine with the SmartKey with KEYLESS-GO:
 - The SmartKey with KEYLESS-GO must be located in the vehicle.
 - All doors must be closed.
 - The brake pedal must be firmly depressed. Do not depress the accelerator.
- If the SmartKey with KEYLESS-GO is positioned farther away from the vehicle, the system may no longer recognize the SmartKey with KEYLESS-GO. The vehicle then cannot be locked or the engine started via the KEYLESS-GO system.
- If the SmartKey with KEYLESS-GO is removed from the vehicle (e.g. if passenger exits the vehicle with the SmartKey with KEYLESS-GO).

Locking and unlocking

- with the starter switch position **1**, the message:
Key Not Detected
appears in the multifunction display
- with the engine running, the message:
Key Not Detected
appears in the multifunction display while driving off.

Find the SmartKey with KEYLESS-GO or change its present location immediately (e.g. place it on the front passenger seat or insert it in shirt pocket).

- If you have started the engine with the KEYLESS-GO start/stop button (▷ page 39), you can turn it off again with:
 - the KEYLESS-GO start/stop button
 - the SmartKey inserted in the starter switch, when the gear selector lever is in position **P**

- Remember that the engine can be started by anyone with a SmartKey with KEYLESS-GO that is left inside the vehicle.

Possibility 1:

(One SmartKey with KEYLESS-GO in the vehicle, one SmartKey with KEYLESS-GO outside the vehicle):
If you leave the SmartKey with KEYLESS-GO behind when exiting and locking the vehicle, no message appears in the multifunction display.

Possibility 2:

(One SmartKey with KEYLESS-GO in the vehicle, no SmartKey with KEYLESS-GO outside the vehicle):
When exiting and trying to lock the vehicle, the message
Key Detected In Vehicle
will appear in the multifunction display.
The vehicle will not be locked.

Factory setting

i When unlocking or locking the vehicle with the SmartKey with KEYLESS-GO an acoustic signal sounds. The acoustic signal is activated at the factory. If you wish to deactivate the feature, or adjust its signal volume, contact an authorized Mercedes-Benz Center.

Global unlocking

- ▶ Pull an outside door handle (SmartKey with KEYLESS-GO must be near this door).
 - All turn signal lamps flash once.
 - An acoustic signal sounds once.
 - The locking knobs in the doors move up.
 - The anti-theft alarm system is disarmed.

The vehicle will lock again automatically and rearm the anti-theft alarm system within approximately 40 seconds of unlocking if:

- neither door nor trunk is opened.
- the central locking switch is not activated.

i *The vehicle could inadvertently be unlocked if the SmartKey with KEYLESS-GO is within 3 ft (1 m) of the vehicle and:*

- *an outside door handle is splashed with water, or*
- *you attempt to clean an outside door handle.*

Global locking

- ▶ Press the lock button on an outside door handle (▷ page 62).



With the trunk and both doors closed:

- All turn signal lamps flash three times.
- An acoustic signal sounds three times.

- The locking knobs in the doors move down.
- The anti-theft alarm system is armed.

Selective setting

If you frequently travel alone, you may wish to reprogram the SmartKey with KEYLESS-GO so when you, pull the driver's door handle only the driver's door and the fuel filler flap unlocks.

- ▶ Press and hold buttons  and  simultaneously for about 5 seconds until battery check lamp ⑤ (▷ page 104) flashes twice.

The SmartKey with KEYLESS-GO will then function as follows:

Unlocking driver's door and fuel filler flap

- ▶ Pull the driver's outside door handle.
 - All turn signal lamps flash once.
 - An acoustic signal sounds once.
 - The locking knob in the driver's door move up.
 - The anti-theft alarm system is disarmed.

Global unlocking

- ▶ Pull the outside door handle on the passenger side.
 - All turn signal lamps flash once.
 - An acoustic signal sounds once.
 - The locking knobs in the doors move up.
 - The anti-theft alarm system is disarmed.

Locking and unlocking

Global locking



- ▶ Press the lock button on an outside door handle.

With the trunk and both doors closed:

- All turn signal lamps flash three times.
- An acoustic signal sounds three times.
- The locking knobs in the doors move down.
- The anti-theft alarm system is armed.

i Vehicles with trunk opening/closing system*, you can also lock the vehicle using the KEYLESS-GO locking/closing switch (▷ page 116) on the trunk lid.

Restoring to factory setting

- ▶ Press and hold buttons  and  simultaneously for about 5 seconds until Battery check lamp  (▷ page 104) flashes twice.

Unlocking and opening the trunk

You can unlock and open the trunk separately.

A minimum height clearance of 5.71 ft (1.74 m) CLK coupe or 5.41 ft (1.65 m) CLK cabriolet is required to open the trunk lid.

- ▶ Press and hold button  until trunk unlocks and begins to open.

! The trunk lid swings open upwards automatically. Always make sure there is sufficient overhead clearance.

Vehicles with trunk opening/closing system*: To stop the opening procedure, press button . The trunk lid stops moving.

i If the trunk does not open, it is still locked separately (▷ page 118).

The trunk can also be opened from its inside in an emergency, see “Trunk emergency release” (▷ page 117).

Checking the batteries in the SmartKey or SmartKey with KEYLESS-GO*



- ▶ Press button  or .

Battery check lamp (▷ page 100) or (▷ page 104) comes on briefly to indicate that the SmartKey or SmartKey with KEYLESS-GO batteries are in order.

! If battery check lamp does not come on briefly during check, the SmartKey or SmartKey with KEYLESS-GO batteries are discharged.

Replace the batteries (▷ page 441).

You can obtain the required batteries at any authorized Mercedes-Benz Center.

i If the batteries are checked within signal range of the vehicle, pressing the  or  button will lock or unlock the vehicle accordingly.

Loss of the SmartKey or SmartKey with KEYLESS-GO*

If you lose your SmartKey, SmartKey with KEYLESS-GO, or mechanical key, you should do the following:

- ▶ Have the SmartKey or SmartKey with KEYLESS-GO deactivated at an authorized Mercedes-Benz Center.
- ▶ Report the loss of the SmartKey, SmartKey with KEYLESS-GO, or the mechanical key immediately to your car insurance company.
- ▶ Have the mechanical lock replaced if necessary.

Any authorized Mercedes-Benz Center will be glad to supply you with a replacement.

Opening the doors from the inside

You can open a locked door from the inside. Open doors only when conditions are safe to do so.

Opening a door causes its windows to open slightly. It will fully close when the door is shut.

! A side window will not work if it is blocked with ice or if the battery needs charging. If you cannot shut a door, do not force it or you could damage the door or the side window. Fix whatever is affecting the window before trying to shut the door.

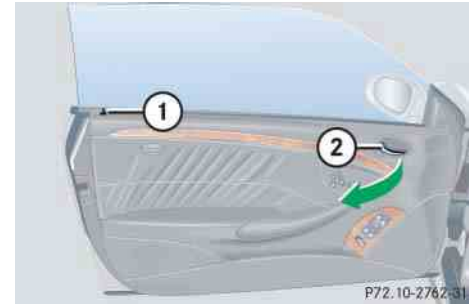



- ① Locking knob
- ② Inside door handle

i If the vehicle has been centrally locked with the SmartKey or KEYLESS-GO*, opening a door from the inside will trigger the anti-theft alarm system.

To cancel the alarm, do one of the following:

With the SmartKey

- Insert the SmartKey in the starter switch.
- Press button  or  on the SmartKey.

With KEYLESS-GO*

- Press the KEYLESS-GO* start/stop button (▷ page 39).



Locking and unlocking

▷▷ The SmartKey with KEYLESS-GO* must be inside the vehicle.

- Pull an outside door handle.

The SmartKey with KEYLESS-GO* must be within 3 ft (1 m) of the vehicle.

- ▶ Pull on door handle ②.

If door was locked, locking knob ① will move up.

i If you hear a warning signal you have forgotten to switch off the low beam headlamps or the parking lamps before opening the driver's door.

In addition the message Switch Off Lights appears in the multifunction display.

Switch off the low beam headlamps or the parking lamps.

If the message Switch Off Lights or Remove Key appears in the multifunction display remove the SmartKey from the starter switch or switch off the automatic headlamp mode.

! Failure to switch off the exterior lamps when leaving the vehicle may result in a discharged battery.

Opening the trunk

Warning!



Make sure the trunk is closed when the engine is running and while driving. Among other dangers, such as blocked visibility, exhaust fumes may enter the vehicle interior. These fumes are damaging to your health.

You can open the trunk if the vehicle is stationary.

A minimum height clearance of 5.71 ft (1.74 m) CLK coupe or 5.41 ft (1.65 m) CLK cabriolet is required to open the trunk lid.

! The trunk lid swings open upwards automatically. Always make sure there is sufficient overhead clearance.

Opening the trunk from the outside

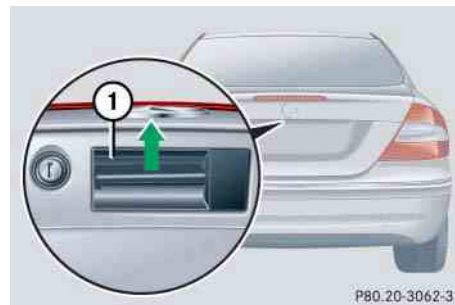

- ① Handle

▶ Press and hold button  on the SmartKey or SmartKey with KEYLESS-GO* until trunk unlocks and begins to open.

or

- ▶ Pull on handle ①.

In vehicles without KEYLESS-GO*:
The vehicle must be unlocked.

i If the trunk does not open, it is still locked separately (▷ page 118).

! Vehicles with trunk opening/closing system*: To stop the opening procedure, press button  on the SmartKey or SmartKey with KEYLESS-GO*.

i The trunk can also be opened from its inside in an emergency, see “Trunk emergency release” (▷ page 117).

Opening the trunk from the inside



Vehicles without trunk opening/closing system*

- ① Remote trunk opening switch



Vehicles with trunk opening/closing system*

- ① Remote trunk opening switch*
 - ② Remote trunk closing switch*
- ▶ Press remote trunk opening switch ① until the trunk begins to open.

The trunk opens. The indicator lamp comes on and remains lit until the trunk is closed.

i If the trunk does not open, it is still locked separately (▷ page 118).

! Vehicles with trunk opening/closing system*: To stop the opening procedure, press switch ① or ②.

i The trunk can also be opened using button  on the SmartKey or SmartKey with KEYLESS-GO* or from its inside in an emergency, see “Trunk emergency release” (▷ page 117).

Locking and unlocking

Closing the trunk

Closing the trunk from the inside automatically*

In vehicles with trunk opening/closing system* you can close the trunk from the inside using the remote trunk closing* switch.

- ▶ Press the remote trunk closing* switch ② (▷ page 111) until the indicator lamp in the switch goes out and the trunk lid is closed.

To interrupt the closing procedure:

- ▶ Release remote trunk closing* switch ②.

i You can also close the trunk by hand (▷ page 113).

Warning!



Maintain sight of trunk area while operating the door mounted remote trunk closing* switch. Monitor the closing procedure carefully to ensure that no one is in danger of being injured.

To interrupt the closing procedure, release the door mounted remote trunk closing switch.

Even with the SmartKey or the SmartKey with KEYLESS-GO* removed from the starter switch or the SmartKey with KEYLESS-GO* removed from the vehicle, the remote trunk opening/closing* switch can be operated. Therefore, do not leave children unattended in the vehicle, or with access to an unlocked vehicle. Unsupervised use of vehicle equipment may cause an accident and/or serious personal injury.

Warning!



Only drive with the trunk closed as, among other dangers such as blocked visibility, exhaust fumes may enter the vehicle interior.

If the trunk lid comes into contact with an object while closing (e.g. luggage that has been piled too high), in the sequence, the upper motion the closing procedure is stopped and the trunk reopens slightly.

Closing the trunk from the outside manually

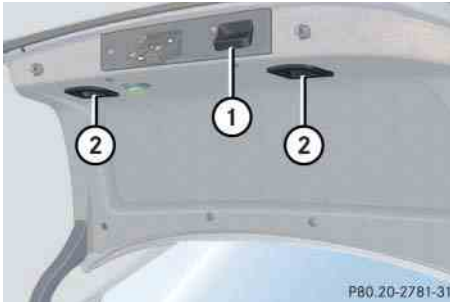

- ① Handle
- ② Handles

- ▶ Lower trunk lid by pulling firmly on handle ① or handles ②.
- ▶ Close trunk from the outside with hands placed flat on the trunk lid.

Warning!



To prevent possible personal injury, always keep hands and fingers away from the trunk lid opening when closing the trunk. Be especially careful when small children are around.

When leaving the vehicle, always remove the SmartKey or SmartKey with KEYLESS-GO* from the starter switch, take it with you, and lock the vehicle. Do not leave children unattended in the vehicle, or with access to an unlocked vehicle. It is possible for children to open a locked door from the inside, which could result in an accident and/or serious personal injury.

Warning!



Only drive with the trunk closed as, among other dangers such as blocked visibility, exhaust fumes may enter the vehicle interior.

i Do not place the SmartKey in the open trunk. You may lock yourself out.

Vehicles with KEYLESS-GO:*

To prevent a possible inadvertent lockout, the trunk lid will open automatically if a SmartKey with KEYLESS-GO is recognized inside the vehicle or in the trunk.*

i If the vehicle was previously centrally locked, the trunk will lock automatically after closing it (▶ page 112). All turn signal lamps flash three times, and an acoustic signal sounds three times, to confirm locking.

Locking and unlocking

Closing the trunk from the outside (vehicles without KEYLESS-GO*)

In vehicle with trunk opening/closing system* you can close the trunk separately.

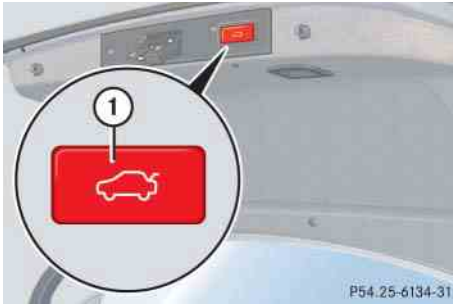

① Trunk closing switch

▶ Press trunk closing switch ① briefly.

The trunk closes.

i You can also close the trunk by hand
(▷ page 113).

If the trunk lid comes into contact with an object while closing (e.g. luggage that has been piled too high), the closing procedure is stopped and the trunk reopens slightly.

Warning!



Monitor the closing procedure carefully to ensure that no one is in danger of being injured. To prevent possible personal injury, always keep hands and fingers away from the trunk opening when closing the trunk. Be especially careful when small children are around. To stop the closing procedure, do one of the following:

- press trunk closing switch ①
- press the  button on the SmartKey
- press the remote trunk opening or closing switch (on driver's door)

Even with the SmartKey removed from the starter switch, the trunk closing switch can be operated. Therefore, do not leave children unattended in the vehicle, or with access to an unlocked vehicle. Unsupervised use of vehicle equipment may cause an accident and/or serious personal injury.

Warning!



Only drive with the trunk closed as, among other dangers such as blocked visibility, exhaust fumes may enter the vehicle interior.

i Do not place the SmartKey in the open trunk. You may lock yourself out.

i If the vehicle was previously centrally locked, the trunk will lock automatically after closing it (▷ page 112). All turn signal lamps flash three times, and an acoustic signal sounds three times, to confirm locking.

Closing the trunk from the outside (vehicles with KEYLESS-GO*)

In vehicles with trunk opening/closing system* you can close the trunk separately.

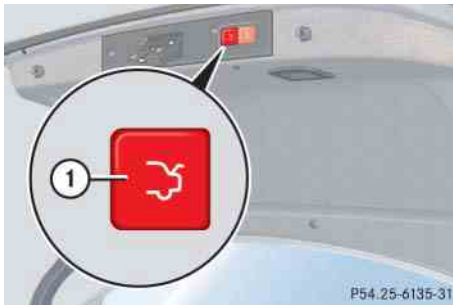

① Trunk closing switch

- ▶ Make sure you have the SmartKey with KEYLESS-GO with you.
- ▶ Press trunk closing switch ① briefly.

The trunk closes.

i You can also close the trunk by hand (▷ page 113).

If the trunk lid comes into contact with an object while closing (e.g. luggage that has been piled too high), the closing procedure is stopped and the trunk reopens slightly.

i To prevent a possible inadvertent lockout, the trunk will open automatically if a SmartKey with KEYLESS-GO is recognized inside the vehicle or in the trunk.

Warning!



Monitor the closing procedure carefully to ensure that no one is in danger of being injured. To prevent possible personal injury, always keep hands and fingers away from the trunk opening when closing the trunk. Be especially careful when small children are around. To stop the closing procedure, do one of the following:

- press trunk closing switch ①
- press KEYLESS-GO locking/closing switch
- press the remote trunk opening or closing switch (on driver's door)

- press the  button on the SmartKey with KEYLESS-GO

Even with the SmartKey with KEYLESS-GO removed from the vehicle, the trunk closing switch can be operated. Therefore, do not leave children unattended in the vehicle, or with access to an unlocked vehicle. Unsupervised use of vehicle equipment may cause an accident and/or serious personal injury.

Warning!



Only drive with the trunk closed as, among other dangers such as blocked visibility, exhaust fumes may enter the vehicle interior.

i If the vehicle was previously centrally locked, the trunk will lock automatically after closing it (▷ page 112). All turn signal lamps flash three times, and an acoustic signal sounds three times, to confirm locking.

Locking and unlocking

Closing the trunk and locking the vehicle from the outside (vehicles with KEYLESS-GO*)

In vehicles with trunk opening/closing system* and KEYLESS-GO, you can close the trunk lid and lock the vehicle simultaneously.

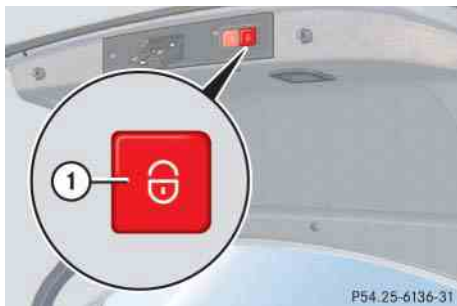

- ① KEYLESS-GO locking/closing switch
- ▶ Make sure you have the SmartKey with KEYLESS-GO with you.
 - ▶ Press switch ① briefly.

With all doors closed, the locking knobs in the doors move down and the trunk starts to close automatically. All

turn signal lamps flash three times to confirm locking once the trunk has closed completely. The anti-theft alarm system is armed.

i You can also close the trunk by hand (▷ page 113).

If the trunk lid comes into contact with an object while closing (e.g. luggage that has been piled too high), the closing procedure is stopped and the trunk reopens slightly.

i To prevent a possible inadvertent lockout, the trunk will open automatically if a SmartKey with KEYLESS-GO is recognized inside the vehicle or in the trunk.

Warning!



Monitor the closing procedure carefully to ensure that no one is in danger of being injured. To prevent possible personal injury, always keep hands and fingers away from the trunk opening when closing the trunk. Be especially careful when small children are around.

To stop the closing procedure, do one of the following:

- press KEYLESS-GO locking/closing switch ①
- press trunk closing switch
- press the  button on the SmartKey with KEYLESS-GO
- press the remote trunk opening or closing switch (on driver's door)

Even with the SmartKey with KEYLESS-GO removed from the vehicle, the trunk closing switch can be operated. Therefore, do not leave children unattended in the vehicle, or with access to an unlocked vehicle. Unsupervised use of vehicle equipment may cause an accident and/or serious personal injury.

Warning!



Only drive with the trunk closed as, among other dangers such as blocked visibility, exhaust fumes may enter the vehicle interior.

Trunk emergency release

With the emergency release button, the trunk can be opened from inside the trunk.

The emergency release button is located on the inside of the trunk lid.



① Emergency release button

- ▶ Briefly press emergency release button ①.

The trunk unlocks and opens slightly.

- ▶ Push up the trunk lid to fully open.

i The emergency release button unlocks and opens the trunk while the vehicle is standing still or in motion.

Illumination of the emergency release button:



- The button will flash for 30 minutes after opening the trunk.
- The button will flash for 60 minutes after closing the trunk.

i The emergency release button does not open the trunk if the vehicle battery is discharged or disconnected.

i If the trunk does not open, it is still locked separately (▷ page 118).

i If the vehicle has previously been locked using the SmartKey or KEYLESS-GO*, opening the trunk from the inside using the emergency release button will trigger the anti-theft alarm system.

To cancel the alarm, do one of the following:

- Insert the SmartKey in the starter switch.
- Press button  or  on the SmartKey.

In vehicles with KEYLESS-GO*:

- Pull an outside door handle.

The SmartKey with KEYLESS-GO* must be within 3 ft (1 m) of the vehicle.

- Press the KEYLESS-GO* start/stop button (▷ page 39).

The SmartKey with KEYLESS-GO* must be inside the vehicle.

Locking and unlocking

Valet locking

i To deny any unauthorized person access to the trunk, e.g. when you valet park the vehicle, lock it separately with the mechanical key. Leave only the SmartKey or SmartKey with KEYLESS-GO* less its mechanical key with the vehicle.

The lock is located next to the handle above the rear license plate recess.

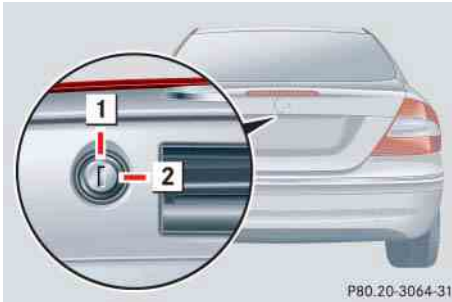

1 Neutral position

2 Locked

- ▶ Close the trunk (▷ page 112).
- ▶ Pull the mechanical key out of the SmartKey (▷ page 427).

- ▶ Insert the mechanical key in the trunk lid lock.
- ▶ Turn the mechanical key clockwise to position **2** and remove the mechanical key in that position to lock the trunk.

The trunk remains locked even when the vehicle is centrally unlocked.

i You can only cancel the separate trunk locking mode by means of the mechanical key.

- ▶ Insert the mechanical key in the trunk lid lock.
- ▶ Turn the mechanical key counterclockwise to neutral position **1** and remove the mechanical key in that position to unlock the trunk.

You can now open the trunk (▷ page 110).

Automatic central locking

The doors and the trunk automatically lock when the ignition is switched on and the wheels are turning at vehicle speeds of approximately 9 mph (15 km/h) or more.

You can open a locked door from the inside. Open doors only when conditions are safe to do so.

i The doors unlock automatically after an accident if the force of the impact exceeds a preset threshold.

To prevent the vehicle door locks from locking, deactivate the automatic central locking when the vehicle

- is pushed or towed
- is on a test stand

You can deactivate the automatic locking mode using the control system, see “Setting automatic locking” (▷ page 166).

Locking and unlocking from the inside

Warning!



When leaving the vehicle, always remove the SmartKey or SmartKey with KEYLESS-GO* from the starter switch, take it with you, and lock the vehicle. Do not leave children unattended in the vehicle, or with access to an unlocked vehicle. A child's unsupervised access to a vehicle could result in an accident and/or serious personal injury.

You can lock or unlock the doors and the trunk from the inside using the central locking or unlocking switch. This can be useful, for example, if you want to lock the vehicle before starting to drive.

The central locking or unlocking switch do not lock or unlock the fuel filler flap and/or the glove box.

The switches are located in the center console.

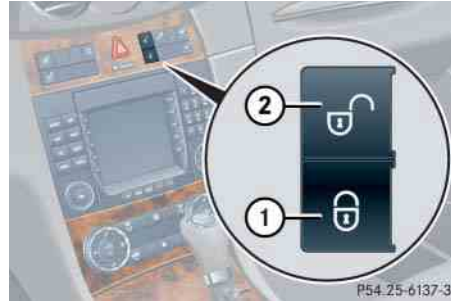

- ① Central locking switch
- ② Central unlocking switch

i You can open a locked door from the inside at any time. Open door only when conditions are safe to do so.

If the vehicle was previously centrally locked with the SmartKey or the SmartKey with KEYLESS-GO, it will not unlock using the central unlocking switch.*

If the vehicle was previously locked with the central locking switch:

- and the SmartKey or SmartKey with KEYLESS-GO* is set to factory settings, the complete vehicle is unlocked when a door is opened from the inside
- and the SmartKey or SmartKey with KEYLESS-GO* is set to selective settings, only the door opened from the inside is unlocked

Locking

- ▶ Press central locking switch ①.

If both doors are closed, the vehicle locks.

Unlocking

- ▶ Press central unlocking switch ②.

The vehicle unlocks.

Seats

For information on seat adjustment, see “Adjusting” (▷ page 41).

Front seat active head restraints

Warning!



For your protection, drive only with properly positioned head restraints.

Adjust the head restraint so that it is as close to the head as possible and the center of the head restraint supports the back of the head at eye level. This will reduce the potential for injury to the head and neck in the event of an accident or similar situation.

You cannot remove the active head restraints on the driver's and front passenger's seat.

For removal of the active head restraints we recommend that you contact an authorized Mercedes-Benz Center.

For information on head restraint adjustment, see “Seats” (▷ page 41).

For information on active head restraints, see “Active head restraints” (▷ page 81).

Rear seat head restraints (CLK coupe)

Warning!



For safety reasons, always drive with the rear head restraints in the upright position when the rear seats are occupied.

Keep the area around head restraints clear of articles (e.g. clothing) to not obstruct the folding operation of the head restraints.

i *Adjust the head restraint in such a way that it is as close to the head as possible.*

Head restraint height

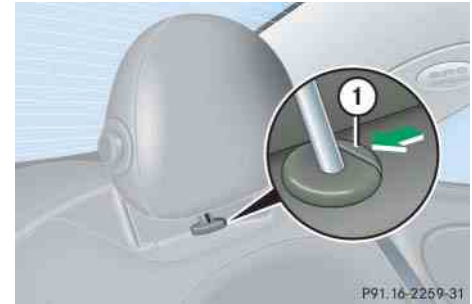

① Release button

Warning!



For your protection, drive only with properly positioned head restraints.

Adjust the head restraint so that it is as close to the head as possible and the center of the head restraint supports the back of the head at eye level. This will reduce the potential for injury to the head and neck in the event of an accident or similar situation.

Do not drive the vehicle without the seat head restraints. Head restraints are intended to help reduce injuries during an accident.

i Adjust the head restraint in such a way that it is as close to the head as possible.

Raising

- ▶ Manually adjust the height of the head restraint by pulling it upward.

If the head restraint is fully retracted, push release button ① and pull the head restraint up.

Lowering

- ▶ To lower the head restraint, push release button ① and push down on the head restraint.

Folding head restraints back with release button

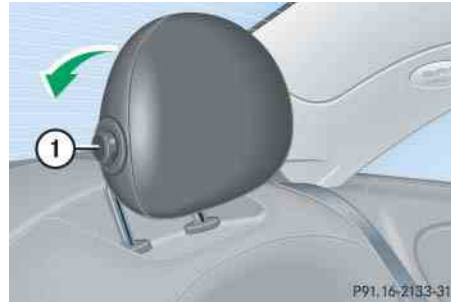

- ① Release button
- ▶ Push release button ①.
The head restraints will fold backward.

i You can also fold the head restraints back using the switch in the center console.

Folding head restraints back with switch in the center console



- ① Rear head restraints folding switch
- ▶ Start the engine (▷ page 51).
- ▶ Press switch ① to release the head restraints.
The head restraints will fold backward.

Seats

Placing rear head restraints upright



- ▶ Pull the rear head restraint forward until it locks into position.

Warning!



Make sure the head restraints engage when placing them upright. Otherwise their protective function cannot be assured.

Head restraint tilt

Two different head restraint angle positions are available.

- ▶ Press the release button (▷ page 121) and tilt the head restraint to the desired position.

i Adjust the head restraint in such a way that it is as close to the head as possible.

Removing and installing rear seats head restraints

Warning!



For your protection, drive only with properly positioned head restraints.

Adjust the head restraint so that it is as close to the head as possible and the center of the head restraint supports the back of the head at eye level. This will reduce the potential for injury to the head and neck in the event of an accident or similar situation.

Do not drive the vehicle without the seat head restraints. Head restraints are intended to help reduce injuries during an accident.

Do not interchange head restraints from front and rear seat.

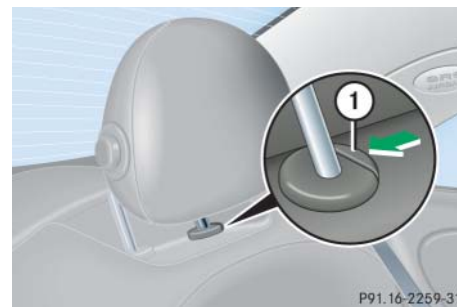

- ① Release button

Removing rear seat head restraints

- ▶ Fold back head restraint (▷ page 121).
- ▶ Pull head restraint to its highest position.
- ▶ Push release button ① and pull out head restraint.

Installing rear head restraints

- ▶ Insert head restraint and push it down until it engages.
- ▶ Push release button ① and adjust head restraint to desired position.

Rear seat head restraints (CLK cabriolet)

Warning!



For safety reasons, always drive with the rear head restraints in the raised position when the rear seats are occupied.

Keep the area around head restraints clear of articles (e.g. clothing) to not obstruct the lowering/raising operation of the head restraints.

Raising rear head restraints

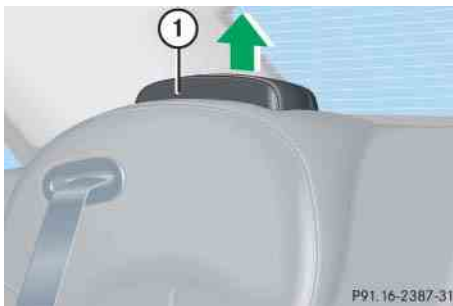

① Rear seat head restraint

- ▶ Pull head restraint ① to its highest position.

Lowering rear head restraints with switch in the center console

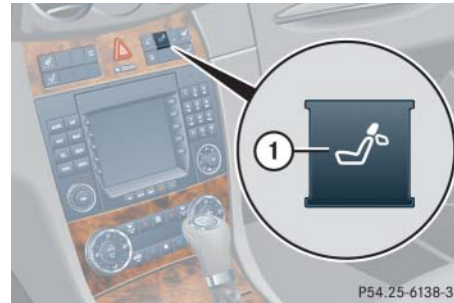

- ① Rear head restraint lowering switch
- ▶ Switch on the ignition (▷ page 38).
- ▶ Push the rear head restraints lowering switch ①.

The rear head restraints are lowered.

i The rear head restraints cannot be lowered using the switch ① when the roll bars have been released. The roll bars need to be lowered before the rear head restraints can be operated again using switch ①.

- If the roll bars have released and the soft top is closed, contact an authorized Mercedes-Benz Center to have the roll bars lowered. Do not attempt to lower the roll bars manually with the soft top closed. Lowering the roll bars manually with the soft top closed may impair the function of the roll bars.
- If the roll bars have released and the soft top is open, you can lower the roll bars manually (▷ page 431) or contact an authorized Mercedes-Benz Center to have the roll bars lowered.

Seats

Multicontour seat*

The multicontour seat has a movable seat cushion and inflatable air cushions built into the backrest to provide additional lumbar and side support.

The seat cushion movement, backrest cushion height and curvature can be continuously varied with switches on the side of the seat after the ignition is switched on (▷ page 40).

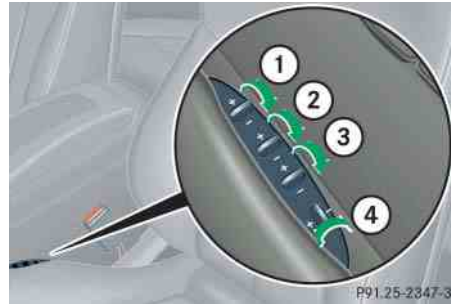

- ① Seat cushion depth
 - ② Backrest bottom
 - ③ Backrest center
 - ④ Side bolster adjustment
- ▶ Switch on ignition (▷ page 40).

Seat cushion depth

- ▶ Adjust the seat cushion depth to the length of your upper leg using switch ①.

Backrest contour

- ▶ Adjust the contour of the backrest to the desired position using switches ② and ③.

Backrest side bolsters

- ▶ Adjust the backrest side bolsters so that they provide good lateral support using switch ④.

i If, after a period of time, the seat no longer provides the desired contour, then repeat the adjustment procedure.

Seat heating*

Both switches for the front seats are located in the center console.



① Seat heating switch

The red indicator lamps on the switch ① show which heating level you have selected.

Level	
3	Three indicator lamps on (highest level). After approximately five minutes, seat heating is automatically switched to level 2.
2	Two indicator lamps on. After approximately ten minutes, seat heating is automatically switched to level 1.
1	One indicator lamp on (lowest level). After approximately 20 minutes, seat heating is automatically switched off.
off	No indicator lamp on.

- ▶ Switch on the ignition (> page 40).

Switching on seat heating

- ▶ Press seat heating switch ① once.
Three red indicator lamps in the switch come on.
- ▶ Continue pressing seat heating switch ① until desired seat heating level is reached.

Switching off seat heating

- ▶ Press seat heating switch ① repeatedly until all red indicator lamps go out.

i If one or more of the indicator lamps on the seat heater switch ① are flashing, there is insufficient voltage due to too many electrical consumers being switched on. The seat heating switches off automatically.

The seat heating will switch back on again automatically as soon as sufficient voltage is available.

Seats

Seat ventilation*

Both switches for the front seats are located in the center console.



① Seat ventilation switch

The blue indicator lamps in the switch ① show which ventilation level you have selected:

Level	
3	Three indicator lamps on
2	Two indicator lamps on
1	One indicator lamp on
off	No indicator lamp on

- ▶ Switch on the ignition (▷ page 40).

Switching on seat ventilation

- ▶ Press seat ventilation switch ①.

Three blue indicator lamps come on.

- ▶ Press seat ventilation switch ① repeatedly until the desired seat ventilation level is reached.

i The seat ventilation for the driver's seat is automatically set to the highest level if activated via summer opening feature (▷ page 253).

Switching off seat ventilation

- ▶ Press seat ventilation switch ① repeatedly until all blue indicator lamps go out.

i If one or more of the indicator lamps on the seat ventilation switch ① are flashing, there is insufficient voltage due to too many electrical consumers being switched on. The seat ventilation switches off automatically.

The seat ventilation will switch back on again automatically as soon as sufficient voltage is available.

▼ Memory function

Prior to operating the vehicle, the driver should check and adjust the seat height, seat position fore and aft, and seat backrest angle if necessary, to ensure adequate control, reach and comfort. The head restraint should also be adjusted for proper height. See also the section on air bags (▷ page 65) for proper seat positioning.

In addition, adjust the steering wheel to ensure adequate control, reach, operation and comfort. Both the interior and exterior rear view mirrors should be adjusted for adequate rear vision.

Fasten seat belts. Infants and small children should be seated in a properly secured restraint system that complies with U.S. Federal Motor Vehicle Safety Standards 213 and 225 and Canadian Motor Vehicle Safety Standards 213 and 210.2.

With the memory function you can store up to three different configuration.

Each stored position on the driver's side includes the following settings:

- Seat position
- Steering wheel position
- Exterior rear view mirror position
- Multicontour seat*: previously saved setting

Warning!



Do not activate the memory function while driving. Activating the memory function while driving could cause the driver to lose control of the vehicle.

Each stored position on the passenger side includes the following setting:

- Seat position

Memory function

The memory button and memory position switch are located on the door.



① Memory button

② Memory position switch

- ▶ Switch on the ignition (▷ page 40).

or

- ▶ Open the respective door and insert the SmartKey in the starter switch.

Storing positions into memory

- ▶ Adjust the seats, steering wheel and exterior rear view mirrors to the desired position (▷ page 42).
- ▶ Turn memory position switch ② to the desired memory position.
- ▶ Press memory button ①.
- ▶ Release memory button ① and press memory position switch ② within 3 seconds.

All settings are stored to the selected position.

Recalling positions from memory

! Do not operate the seats using the memory button if the seat backrest is in an excessively reclined position. Doing so could cause damage to front or rear seats.

First move the seat backrest to an upright position.

- ▶ Turn memory position switch ② to the desired memory position.
- ▶ Press and hold memory position switch ② until the seat, steering wheel and exterior rear view mirrors have completely moved to the stored positions.

i Releasing the memory position switch stops movement to the stored positions immediately.

▼ Lighting

For information on how to switch on the headlamps and use the turn signals, see “Switching on headlamps” (▷ page 55) and “Turn signals” (▷ page 56).

i If you drive in countries where vehicles drive on the other side of the road than the country where the vehicle is registered, you must have the headlamps modified for symmetrical low beams. Relevant information can be obtained at any authorized Mercedes-Benz Center.

i Vehicles equipped with active Bi-Xenon* headlamps:

The active Bi-Xenon headlamps monitor your steering angle and driving speed, then automatically shift their beams to either side to better follow the curvature of the road ahead, increasing usable illumination over conventional headlamps.

Exterior lamp switch



- 1 **←P** Standing lamps, left (turn left two stops)
- 2 **P→** Standing lamps, right (turn left one stop)
- 3 **0** Off
Daytime running lamp mode (▷ page 131)
- 4 **AUTO** Automatic headlamp mode
Daytime running lamp mode (▷ page 131)

- 5 **☰** Parking lamps (also tail lamps, license plate lamps, side marker lamps, instrument panel lamps)
- 6 **☰** Low beam headlamps or high beam headlamps.
- 7 **☰** Front fog lamps
- 8 **☰** Rear fog lamp

i If you hear a warning signal you have forgotten to switch off the low beam headlamps or the parking lamps before opening the driver’s door.

In addition the message Switch Off Lights appears in the multifunction display.

Switch off the low beam headlamps or the parking lamps.

If the message Switch Off Lights or Remove Key appears in the multifunction display remove the SmartKey from the starter switch or switch off the automatic headlamp mode.

! Failure to switch off the exterior lamps when leaving the vehicle may result in a discharged battery.

Lighting

Low beam headlamps

The low beam headlamps can be switched on and off with the exterior lamp switch using the manual headlamp mode.

- ▶ Turn the exterior lamp switch to position .

The following lamps switch on:

- Low beam headlamps
- Tail and parking lamps
- License plate lamps
- Side marker lamps

Automatic headlamp mode

The following lamps switch on and off automatically depending on the brightness of the ambient light:



- Low beam headlamps
- Tail and parking lamps
- License plate lamps
- Side marker lamps

Warning!



If the exterior lamp switch is set to **AUTO**, the headlamps will not be automatically switched on under foggy conditions.

To minimize risk to you and to others, activate headlamps by turning exterior lamp switch to  when driving or when traffic and/or ambient lighting conditions require you to do so.



In low ambient lighting conditions, only switch from position **AUTO** to  with the vehicle at a standstill in a safe location. Switching from **AUTO** to  will briefly switch off the headlamps. Doing so while driving in low ambient lighting conditions may result in an accident.

The automatic headlamp feature is only an aid to the driver. The driver is responsible for the operation of the vehicle's lights at all times.

- ▶ Turn the exterior lamp switch to position **AUTO**.

With the SmartKey in starter switch position **1** or the KEYLESS-GO* start/stop button pressed once, the tail and parking lamps, the license plate lamps and the side marker lamps will switch on and off depending on the brightness of the ambient light.

When the engine is running, the low beam headlamps, the tail and parking lamps, the license plate lamps, and the side marker lamps will switch on and off depending on the brightness of the ambient light.

 *Canada only:*
High beam headlamps are only available with the exterior lamp switch in position .

Daytime running lamp mode

The daytime running lamp mode is mandatory and therefore in a constant mode.

In the USA the daytime running lamp mode is deactivated by default. Activate the daytime running lamp mode using the control system, see “Setting daytime running lamp mode (USA only)” (▷ page 162).

- ▶ Turn the exterior lamp switch to position **0** or **AUTO**.

When the engine is running, the low beam headlamps are switched on.

In low ambient light conditions, the following lamps will switch on additionally:

- Tail and parking lamps
- License plate lamps
- Side marker lamps

i With the daytime running lamp mode activated and the engine running, you cannot switch off the low beam headlamps manually.

Canada only



i With the exterior lamp switch in position **0** or **AUTO**, you cannot switch on the high beam headlamps.

The high beam flasher is available at all times.

For nighttime driving turn the exterior lamp switch to position  to permit activation of the high beam headlamps.

When the engine is running, and you shift from a driving position to position **N** or **P**, with the vehicle at a standstill the low beam headlamps will switch off with a delay of 3 minutes.

When the engine is running, and you

- turn the exterior lamp switch to position , the low beam headlamps, the tail and parking lamps, the license plate lamp and the side marker lamps switch on.
- turn the exterior lamp switch to position , the manual headlamp mode has priority over the daytime running lamp mode.



The corresponding exterior lamps switch on (▷ page 129).

USA only

i With the daytime running lamp mode activated and the exterior lamp switch in position **0**, you cannot switch on the high beam headlamps.

The high beam flasher is available at all times.

*For nighttime driving turn the exterior lamp switch to position  or **AUTO** to permit activation of the high beam headlamps.*

When the engine is running, and you turn the exterior lamp switch to position  or , the manual headlamp mode has priority over the daytime running lamp mode.

The corresponding exterior lamps switch on (▷ page 129).

Lighting



Locator lighting and night security illumination

Locator lighting and night security illumination are described in the “Control system” section, see “Setting locator lighting” (▷ page 163) and “Setting night security illumination (Headlamps delayed shut-off)” (▷ page 164).



Fog lamps

Warning!





In low ambient lighting or foggy conditions, only switch from position **AUTO** to  with the vehicle at a standstill in a safe location. Switching from **AUTO** to  will briefly switch off the headlamps. Doing so while driving in low ambient lighting conditions may result in an accident.

 *Fog lamps will operate with the parking lamps and/or the low beam headlamps on. Fog lamps should only be used in conjunction with low beam headlamps. Consult your State or Province Motor Vehicle Regulations regarding permissible lamp operation.*

 *Fog lamps cannot be switched on with the exterior lamp switch in position **AUTO**. To switch on the fog lamps, turn the exterior lamp switch to position  first.*

Front fog lamps

- ▶ Turn the exterior lamp switch to position  or  (▷ page 55).
- ▶ Pull out the exterior lamp switch to first stop.

The front fog lamps switch on.

The green indicator lamp  in the exterior lamp switch comes on (▷ page 129).

- ▶ Push in the exterior lamp switch.

The front fog lamps switch off.

The green indicator lamp  in the exterior lamp switch goes out.

Rear fog lamp (driver's side only)

- ▶ Turn the exterior lamp switch to position  (▷ page 55).
- ▶ Pull out the exterior lamp switch to second stop.

The front fog lamps and the rear fog lamp switch on.

The yellow indicator lamp  in the exterior lamp switch comes on (▷ page 129).

- ▶ Push in the exterior lamp switch to first stop.

The rear fog lamp switches off.

The yellow indicator lamp  in the exterior lamp switch goes out. The front fog lamps remain lit.

Combination switch

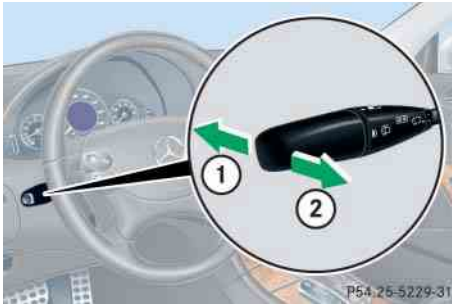

Combination switch

- ① High beam
- ② High beam flasher

High beam

- ▶ Turn the exterior lamp switch to position  (▷ page 129).
- ▶ Push the combination switch in direction of arrow ① to switch on the high beam.

The high beam headlamp indicator lamp  in the instrument cluster comes on (▷ page 28).

- ▶ Pull the combination switch in direction of arrow ② to its original position to switch off the high beam.

The high beam headlamp indicator lamp  in the instrument cluster goes out.

High beam flasher

- ▶ Pull the combination switch briefly in the direction of arrow ②.

Corner-illuminating front fog lamps* (With Bi-Xenon* headlamps only)

The corner-illuminating front fog lamps improve illumination of the area in the direction into which you are turning.

The corner-illuminating front fog lamps will operate with the engine running and with

- the exterior lamp switch in position  (▷ page 129)
- or
- the exterior lamp switch in position **AUTO** (▷ page 129)
- or
- the daytime running lamp mode activated (▷ page 131)

 *The corner-illuminating front fog lamps will only come on in low ambient lighting conditions.*

 *If you are driving faster than 25 mph (40 km/h) or have the front fog lamps switched on, the corner-illuminating front fog lamps function is not available.*

Lighting

Driving forward

Switching on corner-illuminating front fog lamps

- ▶ Switch on the left or right turn signal (▷ page 56), depending on whether you are turning left or right.

The respective front fog lamp comes on and illuminates the area in the direction into which you are turning.

or

- ▶ Turn steering wheel in desired direction.

The front fog lamp on the side of your steering direction comes on.

i *If you have switched on the turn signal for one side but turn the steering wheel in the opposite direction, the corner-illuminating front fog lamp comes on for the side indicated by the turn signal.*

The corner-illuminating front fog lamp remains lit for a maximum of three minutes. Afterward, it goes out even if the turn signal is still switched on.

i *The corner-illuminating front fog lamps temporarily come on, on both sides of the vehicle if you turn the steering wheel in one direction and then again in the other direction shortly thereafter.*

i *The corner-illuminating front fog lamps will come on automatically depending on the steering angle, even if you did not switch on either turn signal.*

If the corner-illuminating front fog lamps came on automatically, they will also go out automatically depending on the steering angle.

Switching off corner-illuminating front fog lamps

The combination switch for the turn signal resets automatically after major steering wheel movements. This will switch off the corner-illuminating front fog lamps if they were activated by switching on the left or right turn signal.

If the turn signal should stay on after making the turn, the turn signal and the corner-illuminating front fog lamp can be switched off by returning the combination switch to its original position.

i *There may be a brief delay before the corner-illuminating front fog lamps switch off.*

Driving in reverse

Switching on corner-illuminating front fog lamps

- ▶ Place the gear selector lever in position **R**.

The front fog lamp opposite to your steering direction comes on.

Switching off corner-illuminating front fog lamps

- ▶ Place the gear selector lever out of position **R**.

The respective front fog lamp goes out.

Hazard warning flasher

The hazard warning flasher can be switched on at all times, even with the SmartKey removed from the starter switch or with the SmartKey with KEYLESS-GO* removed from the vehicle.

The hazard warning flasher switches on automatically when an air bag deploys.

The hazard warning flasher switch is located on the center console.



- ① Hazard warning flasher switch

Switching on hazard warning flasher

- ▶ Press hazard warning flasher switch ①.

All turn signal lamps are flashing.

i With the hazard warning flasher activated and the combination switch set for either left or right turn, only the respective left or right turn signals will operate when the ignition is switched on (▷ page 40).

Switching off hazard warning flasher

- ▶ Press hazard warning flasher switch ① again.

i If the hazard warning flasher has been activated automatically, press hazard warning flasher switch ① once to switch it off.

Lighting

Interior lighting

The controls are located in the overhead control panel.



- ① Rear interior lighting on/off (CLK coupe only)
- ② Right front reading lamp on/off
- ③ Rocker switch for automatic control system
- ④ Left front reading lamp on/off

! An interior lamp switched on manually does not go out automatically.

Leaving an interior lamp switch in the ON position for extended periods of time with the engine turned off could result in a discharged battery.

Deactivating automatic control

i The interior lighting is factory-set to automatic mode.

- ▶ Press the  symbol on rocker switch ③.

The interior lighting remains switched off in darkness, even when you

- unlock the vehicle
- remove the SmartKey from the starter switch
- open a door
- open the trunk

Activating automatic control

- ▶ Press rocker switch ③ to center position.

The interior lighting switch on in darkness, when you

- unlock the vehicle
- remove the SmartKey from the starter switch
- open a door
- open the trunk

The interior lighting switches off after approximately 10 seconds, see “Setting interior lighting delayed shut-off” (▷ page 165).



i If a door remains open, the interior lighting switches off automatically after approximately 5 minutes.

Manual control



Switching front interior lighting on and off

- ▶ Press the  symbol on rocker switch ③.
The front interior lighting comes on.
- ▶ Press rocker switch ③ to center position to activate the automatic control.

Switching rear interior lighting on and off (CLK coupe only)

- ▶ Press button .
The lighting in the rear passenger compartment comes on.
- ▶ Press button  again.
The lighting in the rear passenger compartment goes out.

Switching front reading lamps on and off

- ▶ Press the left or right button  to switch on the desired front reading lamp.
- ▶ Press the left or right button  again to switch off the respective front reading lamp.

Door entry lamps

For better orientation in the dark, the corresponding door entry lamps will switch on in darkness when you open a door and the automatic control is activated.

The door entry lamps will switch off when the corresponding door is closed.

i If you turn the SmartKey in the starter switch to position **0** and switch off the headlamps, the door entry lamps will remain lit for approximately 5 minutes.

Trunk lamp

The trunk lamp switches on if the trunk is opened.

If the trunk lid remains open, the trunk lamp switches off automatically after approximately 10 minutes.

Instrument cluster

For a full view illustration of the instrument cluster, see “Instrument cluster” (▷ page 28).

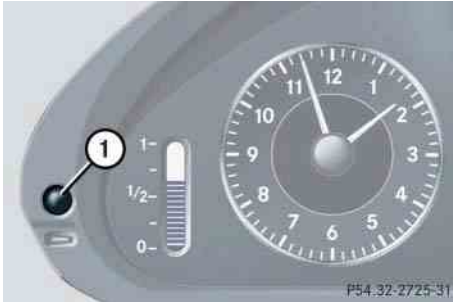

① Reset button

The instrument cluster is activated when you

- open a door
- switch on the ignition (▷ page 40)
- press the reset button ①
- switch on the exterior lamps

You can change the instrument cluster settings in the Instrument cluster submenu of the control system (▷ page 158).

Warning!



No messages will be displayed if either the instrument cluster or the multifunction display is inoperative.

As a result, you will not be able to see information about your driving conditions, such as speed or outside temperature, warning/indicator lamps, malfunction/warning messages or the failure of any systems. Driving characteristics may be impaired.

If you must continue to drive, please do so with added caution. Visit an authorized Mercedes-Benz Center as soon as possible.

Adjusting instrument cluster illumination

Use the reset button ① to adjust the illumination brightness for the instrument cluster.

i *The instrument cluster illumination is dimmed or brightened automatically to suit ambient light conditions.*

The instrument cluster illumination will also be adjusted automatically when you switch on the vehicle's exterior lamps.

To brighten illumination

- ▶ Turn reset button ① clockwise.

The instrument cluster illumination will brighten.

To dim illumination

- ▶ Turn reset button ① counterclockwise.

The instrument cluster illumination will dim.

Coolant temperature indicator

The coolant temperature indicator is on the right side in the instrument cluster (▷ page 28).

Warning!



- Driving when your engine is overheated can cause some fluids which may have leaked into the engine compartment to catch fire. You could be seriously burned.
- Steam from an overheated engine can cause serious burns which can occur just by opening the hood. Stay away from the engine if you see or hear steam coming from it.



Stop the vehicle in a safe location away from other traffic. Turn off the engine, get out of the vehicle and do not stand near the vehicle until the engine has cooled down.

! Excessive coolant temperature triggers a warning in the multifunction display (▷ page 406) and the red coolant warning lamp in the instrument cluster comes on (▷ page 383).

The engine should not be operated with the coolant temperature above 248°F (120°C). Doing so may cause serious engine damage which is not covered by the Mercedes-Benz Limited Warranty.

i During severe operating conditions, e.g. stop-and-go traffic, the coolant temperature may rise close to 248°F (120°C).

Resetting trip odometer

- ▶ Make sure you are viewing the standard display in the multifunction display (▷ page 147).
- ▶ If it is not displayed, press button  or  on the multifunction steering wheel repeatedly until the standard display appears (▷ page 142).
- ▶ Press and hold the reset button on the instrument cluster (▷ page 138) until the trip odometer is reset.

Tachometer

The red marking on the tachometer (▷ page 28) denotes excessive engine speed.

! *Avoid driving at excessive engine speeds, as it may result in serious engine damage that is not covered by the Mercedes-Benz Limited Warranty.*

To help protect the engine, the fuel supply is interrupted if the engine is operated within the red marking.

Clock

In vehicles with Audio 20, the clock can be set via the control system (▷ page 160).

i *Vehicles with COMAND*:
For information on setting the time in COMAND, refer to the separate COMAND operating instructions.*

Outside temperature indicator

Warning!



The outside temperature indicator is not designed to serve as an ice-warning device and is therefore unsuitable for that purpose.

Indicated temperatures just above the freezing point do not guarantee that the road surface is free of ice. The road may still be icy, especially in wooded areas or on bridges.

The outside temperature is indicated in the multifunction display (▷ page 141).

The outside temperature sensor is located in the front bumper area. Due to its location, the sensor can be affected by road or engine heat during idling or slow driving. This means that the accuracy of the displayed temperature can only be verified by comparison to a thermometer placed next to the sensor, not by comparison to external displays (e.g. bank signs etc.).

When moving the vehicle into colder ambient temperatures (e.g. when leaving your garage), you will notice a delay before the lower temperature is displayed.

A delay also occurs when ambient temperatures rise. This prevents inaccurate temperature indications caused by heat radiated from the engine during idling or slow driving.

▼ Control system

The control system is activated as soon as the SmartKey in the starter switch is turned to position **1** or as soon as the KEYLESS-GO* start/stop button is in position **1**. The control system enables you to

- call up information about your vehicle
- change vehicle settings

For example, you can use the control system to find out when your vehicle is next due for service, to set the language for messages in the instrument cluster display, and much more.

i *The displays for the audio systems (radio, CD player etc.) will appear in English, regardless of the language selected.*

Warning!



A driver's attention to the road and traffic conditions must always be his/her primary focus when driving.

For your safety and the safety of others, selecting features through the multifunction steering wheel should only be done by the driver when traffic and road conditions permit it to be done safely.

Bear in mind that at a speed of just 30 mph (approximately 50 km/h), your vehicle is covering a distance of 44 feet (approximately 14 m) every second.

The control system relays information to the multifunction display.

Multifunction display



- ① Outside temperature
- ② Trip odometer
- ③ Current shift program mode
- ④ Main odometer
- ⑤ Current gear selector lever position/gear range

For more information on menus displayed in the multifunction display, see “Menus” (▷ page 144).

Control system

Multifunction steering wheel

The displays in the multifunction display and the settings in the control system are controlled by the buttons on the multifunction steering wheel (> page 30).

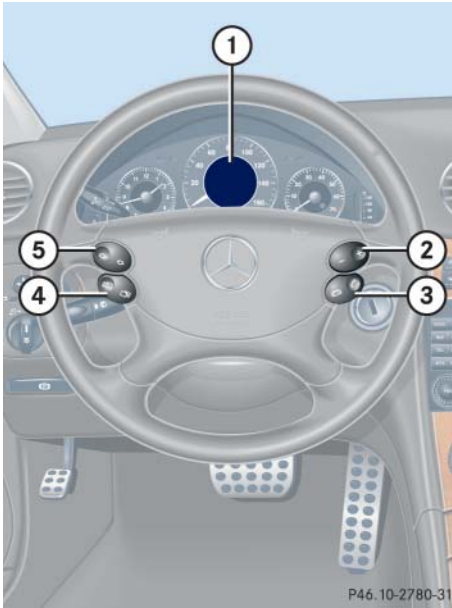

① Multifunction display

Operating the control system

② Selecting the submenu or setting the volume:

Press button

+ up / to increase

- down / to decrease

③ Telephone*:

Press button

 to take a call
to dial
to redial

 to end a call
to reject an incoming call

④ Menu systems:

Press button

 for next menu

 for previous menu

⑤ Moving within a menu:

Press button

 for next display





 for previous display

Depending on the selected menu (▷ page 144), pressing the buttons on the multifunction steering wheel will alter what is shown in the multifunction display.

The information available in the multifunction display is arranged in menus, and accompanying functions or submenus.

The individual functions are then found within the relevant menu (radio or CD operations under *Audio*, for example). These functions serve to call up relevant information or to customize the settings for your vehicle.

It is helpful to think of the menus, and the functions within each menu, as being arranged in a circular pattern.

- If you press button  or  repeatedly, you will pass through each menu one after the other.
- If you press button  or  repeatedly, you will pass through each function display, one after the other, in the current menu.

In the *Settings...* menu, instead of functions you will find a number of submenus for calling up and changing settings. For instructions on using these submenus, see “Submenus in the Settings menu” (▷ page 156).

The number of menus available in the system depends on which optional equipment is installed in your vehicle.

The menus are described on the following pages.

Control system

Menus

This is what you will see when you scroll through the menus.

The table on the next page provides an overview of the individual menus.

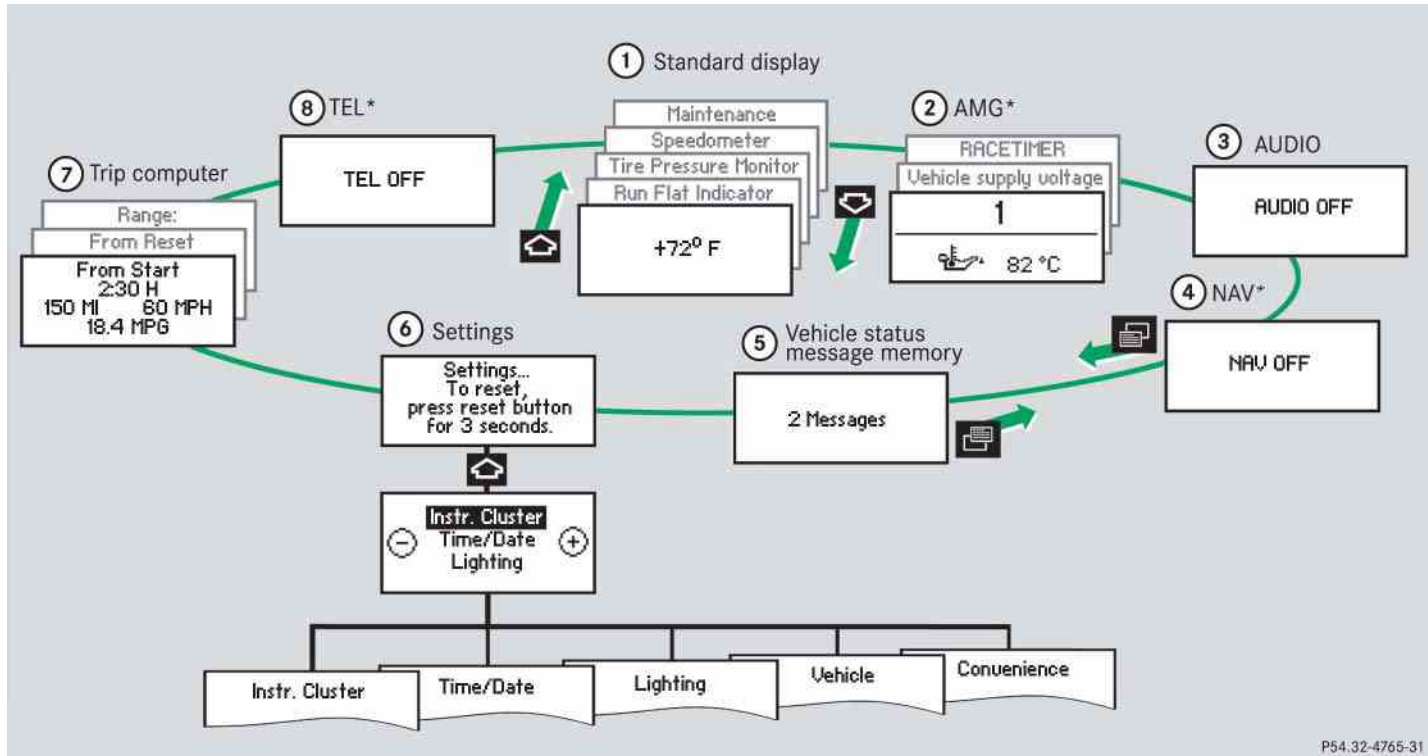

Menus, submenus and functions

	Menu ①	Menu ②	Menu ③	Menu ④
	Standard display (▷ page 147)	AMG¹ (▷ page 148)	AUDIO (▷ page 151)	NAV* (▷ page 153)
Commands/submenus	Run Flat Indicator (Canada only)	Engine oil temperature	Selecting radio station	Show route guidance instructions, current direction traveled
	Tire Pressure Monitoring (USA only)	Vehicle supply voltage	Selecting satellite radio station*	
	Digital speedometer	RACETIMER	Operating CD player	
	Call up maintenance service display	Overall analysis Lap analysis		

¹ AMG vehicles only

Table continued on next page.

Control system

	Menu ⑤ Vehicle status message memory ¹ (▷ page 154)	Menu ⑥ Settings (▷ page 155)	Menu ⑦ Trip computer (▷ page 167)	Menu ⑧ TEL* (▷ page 169)
Commands/submenus	Calling up vehicle malfunction, warning and system status messages stored in memory	Reset to factory settings	Fuel consumption statistics since start	Load phone book
		Instrument cluster submenu	Fuel consumption statistics since the last reset	Search for name in phone book
		Time/Date submenu	Call up range	
		Lighting submenu		
		Vehicle submenu Convenience submenu		

¹ The vehicle status message memory menu is only displayed if there is a message stored.

i *The headings used in the menus table are designed to facilitate navigation within the system and are not necessarily identical to those shown in the control system displays.*

The first function displayed in each menu will automatically show you which part of the system you are in.

Standard display menu

In the standard display, the outside temperature and the trip odometer are shown in the multifunction display.

i You can have the digital speedometer displayed instead of the outside temperature in the standard display. You can select the setting in the submenu Instr. Cluster via the function Basic Display (▷ page 159).



- ① Outside temperature
- ② Trip odometer

If you see another display, press button or repeatedly until the standard display appears.

- ▶ Press button or to select the functions in the standard display menu.

The following functions are available:

Function	Page
Run Flat Indicator (Canada only)	342
Tire Pressure Monitoring (USA only)	344
Call up digital speedometer	147
Call up maintenance service display	366

Display digital speedometer

- ▶ Press button or until the digital speedometer appears in the multifunction display.

The current vehicle speed is shown in the multifunction display and the status line appears.



- ① Digital Speedometer
- ② Status line with outside temperature
- ③ Trip odometer



i You can have the digital speedometer displayed instead of the outside temperature in the status line. You can select the setting in the submenu Instr. Cluster via the function Status Line Display (▷ page 159).

Control system

AMG menu

i This function is only available in AMG vehicles.



The main screen of the AMG menu shows you the gear currently engaged as well as the engine oil temperature.

- ▶ Press button  or  repeatedly until the AMG menu appears in the multifunction display.



- ① Gear indicator
- ② Engine oil temperature



i The engine oil temperature value and unit flash if the engine oil temperature has not yet reached 176 °F (80 °C). During this time, avoid driving at full engine speed.

- ▶ Press button  or  to select the following functions in the AMG menu:

Function	Page
Vehicle supply voltage	148
RACETIMER	149
Overall analysis	150
Lap analysis	151

i If the engine reaches the overspeed range in the manual shift program, the menu will be shown in red. In addition, you will see **UP** next to gear indicator ① as a reminder to upshift.

Vehicle supply voltage

- ▶ Press button  or  repeatedly until the AMG menu appears in the multifunction display.
- ▶ Press button  repeatedly until the vehicle supply voltage appears in the multifunction display.





- ① Gear indicator
- ② Vehicle supply voltage

RACETIMER

Warning!

The RACETIMER feature is only for use on roads and in conditions where high speed driving is permitted. Racing on public roads is prohibited under all circumstances and the driver is and must always remain responsible for following posted speed limits.

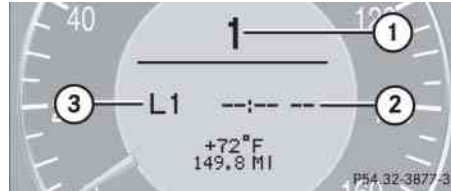

The RACETIMER allows you to time and save driving stretches in hours, minutes and seconds.

- ▶ Press button  or  repeatedly until the AMG menu appears in the multifunction display.
- ▶ Press button  repeatedly until the RACETIMER appears in the multifunction display.



- ① Gear indicator
- ② RACETIMER
- ③ Lap

i You can start the RACETIMER when the engine is running or the starter switch is in position **2** (▷ page 38).

i While the RACETIMER is being displayed, you can not adjust the volume using button  or .

Starting the RACETIMER

- ▶ Press button . The timer starts.

Displaying intermediate time

- ▶ Press button  while the timer is running.

The intermediate time is shown for 5 seconds.

Stopping the RACETIMER

- ▶ Press button .

The timer stops.

i When you stop the vehicle and turn the SmartKey to position **1** (▷ page 38) or, in vehicles with KEYLESS-GO*, turn off the engine and do not open the driver's door, the RACETIMER stops timing. Timing is resumed when you switch the ignition back on (▷ page 38) or restart the engine (▷ page 52) and then press the  button.

Saving lap time and starting a new lap

i You can save up to 9 laps.

- ▶ Press button  while the timer is running.



Control system

▷▷ The intermediate time is shown for 5 seconds.

- ▶ Press button **[-]** within the next 5 seconds.

The intermediate time shown will be saved as a lap time.

The RACETIMER begins timing the new lap. The new lap begins to be timed as soon as the intermediate time is called up.



- ① Gear indicator
- ② RACETIMER
- ③ Best lap time
- ④ Lap number

Resetting current lap

- ▶ Press button **[+]** while the timer is running.

The timer stops.

- ▶ Press button **[-]**.

The lap time is reset to "0".

Deleting all laps

i It is not possible to delete a single saved lap.

- ▶ Press button **[+]** while the timer is running.

The timer stops.

- ▶ Press the reset button twice (▷ page 138).

- ▶ Press button **[+]**.

The timer starts. The saved laps are deleted.

i When you turn off the engine, the RACETIMER will be reset to "0" after 30 seconds. All laps are deleted.

Overall analysis

i These functions are only available if you have saved at least one lap and have stopped the RACETIMER.

- ▶ Press button **[☰]** or **[☷]** repeatedly until the AMG menu appears in the multifunction display.

- ▶ Press button **[↶]** repeatedly until the overall analysis appears in the multifunction display.

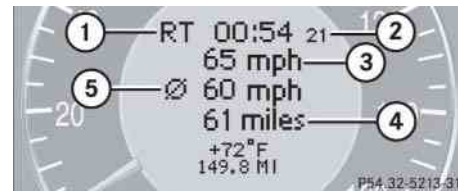

- ① Overall analysis of RACETIMER
- ② Overall driving time
- ③ Maximum speed
- ④ Overall distance driven
- ⑤ Average speed

Lap analysis

i These functions are only available if you have saved at least two laps and have stopped the RACETIMER.

- ▶ Press button or repeatedly until the AMG menu appears in the multifunction display.
- ▶ Press button repeatedly until the lap analysis appears in the multifunction display.

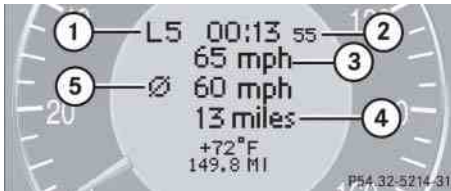

- ① Lap number
 - ② Lap time
 - ③ Maximum speed
 - ④ Lap length
 - ⑤ Average speed during lap
- ▶ Press button or to see other lap analysis.

i Each lap is shown in its own submenu. The fastest lap is indicated by flashing symbol ①.

AUDIO menu

The functions in the Audio menu operate the audio equipment which you currently have turned on.

If no audio equipment is currently turned on, the message Audio Off appears in the multifunction display.

The following functions are available:

Function	Page
Selecting radio station	151
Selecting satellite radio station*	152
Operating CD player	152

Selecting radio station

- ▶ Turn on the radio (▷ page 216) and select radio. Vehicles with COMAND*: Refer to separate operating instructions.

- ▶ Press button or repeatedly until the currently tuned station appears in the multifunction display.



- ① Waveband setting
 - ② Station frequency
- ▶ Press button or repeatedly until the desired station or the desired stored station is found.

The station search depends on the selected setting in the Vehicle submenu of the control system (▷ page 165). Pressing button or will either start a frequency scan or select the next stored radio station.

Control system

i You can only store new stations using the corresponding feature on the radio (▷ page 223).

Vehicles with COMAND*:
Refer to separate operating instructions.

You can also operate the radio in the usual manner.

Selecting satellite radio station*

The satellite radio is treated as a radio application.

- ▶ Select satellite radio with the corresponding soft key (SAT) in the radio menu.



- ① SAT mode and preset number
- ② Setting for station selection using memory
- ③ Channel name or number

- ▶ Press button or repeatedly until the desired channel is found.

i For more information on satellite radio operation, see “Satellite radio*” (▷ page 225).

Vehicles with COMAND*:
Refer to separate operating instructions.

Operating the CD player

i The COMAND* system and the CD changer* can play audio CDs as well as CDs with MP3 files.

Selecting CD track

- ▶ Turn on the radio and select CD (▷ page 233) or CD changer* (▷ page 233). Vehicles with COMAND*: Refer to separate operating instructions.
- ▶ Press button or repeatedly until the settings for the CD currently being played appear in the multifunction display.

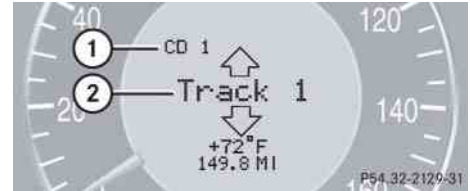

- ① Current CD (with additional number from 1 to 6 when running from CD changer*)

- ② Current track

- ▶ Press button or repeatedly until the desired track is selected.



i To select a CD from the CD changer* magazine, press a number on the audio system or the COMAND* system key pad located in the center console.

For more information on CD operation, see “CD mode” (▷ page 229) and for the CD changer*, see “CD changer*” (▷ page 233).

Selecting CD MP3-track (vehicles with COMAND* and/or CD changer*)

- ▶ Turn on the radio and select the CD changer* (> page 233) or turn on COMAND* and select CD or CD changer*. Vehicles with COMAND*: Refer to separate operating instructions.

i A CD with MP3 files insert in the CD changer* is handled by the audio/COMAND* system like an audio CD. Information contained on the CD with MP3 files will not shown in the multifunction display or in the audio/COMAND* display.

- ▶ Press button  or  repeatedly until the settings for the CD currently being played appear in the multifunction display.

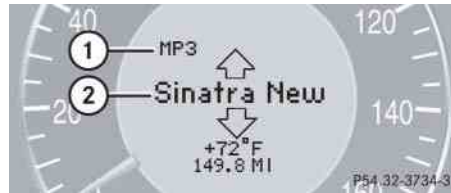

- ① MP3 mode (vehicles with COMAND*)
- ② Current track

- ▶ Press button  or  repeatedly until the desired track is selected.



i Level of information displayed will vary depending on the information contained on the CD with MP3 files insert in the single CD player of the COMAND* system.

To select a CD from the CD changer* magazine, press a number on the audio system or the COMAND* system key pad located in the center console.

For more information on MP3, see “MP3 notes” (> page 230), and for operating, see “MP3 playback” (> page 231)

Navi* menu

The Navi menu contains the functions needed to operate your navigation system.

- ▶ Press button  or  repeatedly until the message Navi appears in the multifunction display.
 - If COMAND* is switched off, the message Navi off appears in the multifunction display.
 - With COMAND* switched on but route guidance not activated, the direction of travel and, if available, the name of the street currently traveled on appear in the multifunction display.
 - With COMAND* switched on and route guidance activated, the direction of travel and maneuver instructions appear in the multifunction display.

Please refer to the COMAND* manual for instructions on how to activate the route guidance system*.

Control system

Vehicle status message memory menu



Use the vehicle status message memory menu to scan malfunction and warning messages that may be stored in the system. Such messages appear in the multifunction display and are based on conditions or system status the vehicle's system recorded.

The vehicle status message memory menu only appears if there are any messages stored.

Warning!



Malfunction and warning messages are only indicated for certain systems and are intentionally not very detailed. The malfunction and warning messages are simply a reminder with respect to the operation of certain systems and do not replace the owner's and/or driver's responsibility to maintain the vehicle's operating safety by having all required maintenance and safety checks performed on the vehicle and by bringing the vehicle to an authorized Mercedes-Benz Center to address the malfunction and warning messages (▷ page 392).

- ▶ Press button  or  repeatedly until the vehicle status message memory appears in the multifunction display.

If the vehicle status message memory menu does not appear, then there are no messages stored.

Vehicle status messages have been recorded

If conditions have occurred causing status messages to be recorded, the number of messages appears in the multifunction display:



- ① Number of messages

- ▶ Press button  or .

The stored messages will now be displayed in the order in which they have occurred.



For malfunction and warning messages, see “Vehicle status messages in the multifunction display” (▷ page 392).

Should the vehicle's system record any conditions while driving, the number of messages will reappear in the multifunction display when the SmartKey in the starter switch is turned to position **0** or removed from the starter switch. With KEYLESS-GO*, turn off the engine by pressing the KEYLESS-GO* start/stop button and open the driver's door.

i *The vehicle status message memory will be cleared when you switch on the ignition (▷ page 40). You will then only see high-priority messages in the multifunction display (▷ page 392).*

Settings menu

In the Settings... menu there are two functions:

- The function **Reset to factory settings?**, with which you can reset all the settings to the original factory settings.
 - A collection of submenus with which you can make individual settings for your vehicle.
- ▶ Press button  or  repeatedly until the Settings... menu appears in the multifunction display.



Resetting all settings

You can reset all the functions of all submenus to the factory settings.

- ▶ Press the reset button in the instrument cluster (▷ page 138) for approximately three seconds.

The request to press the reset button once more to confirm appears in the multifunction display.



- ▶ Press the reset button once more.

The functions of all the submenus will reset to factory settings.

Control system

i *The settings you have changed will not be reset unless you confirm the action by pressing the reset button a second time. After approximately five seconds, the Settings... menu reappears in the multifunction display.*

For safety reasons, the following function is not reset while driving:

- the Headlamp Mode function in the Lighting submenu.

Submenus in the Settings menu



- ▶ Press button .



The collection of the submenus appears in the multifunction display.





- ▶ Press button .

The selection marker moves to the next submenu.

The submenus are arranged by hierarchy. Scroll down with button , scroll up with button .

With the selection marker on the desired submenu, use button  to access the individual functions within that submenu. Once within the submenu, you can use button  to move to the next function or button  to move to the previous function within that submenu.

The settings themselves are made with button  or .

Resetting the functions of a submenu

For each submenu you can reset all the functions to the factory settings.

- ▶ Move to a function in the submenu.
- ▶ Press the reset button (▷ page 138) in the instrument cluster for approximately three seconds.

The request to press the reset button once more to confirm appears in the multifunction display.

- ▶ Press the reset button once more.

All functions of the submenu will reset to factory settings.

i *The settings you have changed will not be reset unless you confirm the action by pressing the reset button a second time. After approximately five seconds, the Settings... menu reappears in the multifunction display.*

The table below shows what settings can be changed within the various menus.

Detailed instructions on making individual settings can be found on the following pages.

Instrument Cluster (▷ page 158)	Time/Date (▷ page 160)	Lighting (▷ page 162)	Vehicle (▷ page 165)	Convenience (▷ page 166)
Selecting speedometer display mode	Setting time (hours)	Setting daytime running lamp mode (USA only)	Selecting audio search function	Activate easy-entry/exit feature
Selecting language	Setting time (minutes)	Setting locator lighting	Setting automatic locking	
Selecting display (speed display or outside temperature) for status indicator	Setting the date (month)	Setting night security illumination		
Selecting display (speed display or outside temperature) for standard display	Setting the date (day)	Setting interior lighting delayed shut-off		
	Setting the date (year)			

Control system

Instrument cluster submenu

Access the Instr. Cluster submenu via the Settings... menu. Use the Instr. Cluster submenu to change the instrument cluster display settings.

The following functions are available:

Function	Page
Selecting speedometer display mode	158
Selecting language	158
Selecting display (speed display or outside temperature) for status line	159
Selecting display (speed display or outside temperature) for standard display	159

Selecting speedometer display mode

- ▶ Move the selection marker with button **+** or **-** to the Instr. Cluster submenu.
- ▶ Press button **▲** or **▼** repeatedly until the message Display Unit Speed-/odometer appears in the multifunction display.

The selection marker is on the current setting.



- ▶ Press button **+** or **-** to set speedometer unit to KM or Miles.

Selecting language

- ▶ Move the selection marker with button **+** or **-** to the Instr. Cluster submenu.
- ▶ Press button **▲** or **▼** repeatedly until the message Language appears in the multifunction display.

The selection marker is on the current setting.



- ▶ Press button **+** or **-** to select the language to be used for the multifunction display messages.

Available languages:

- German
- English
- French
- Italian
- Spanish
- Dutch
- Danish
- Swedish
- Portuguese
- Turkish
- Russian (Canada only)

Selecting display (speed display or outside temperature) for status line

- ▶ Move the selection marker with button **+** or **-** to the Instr. Cluster submenu.
 - ▶ Press button **▲** or **▼** repeatedly until the message Status Line Display appears in the multifunction display.
- The selection marker is on the current setting.

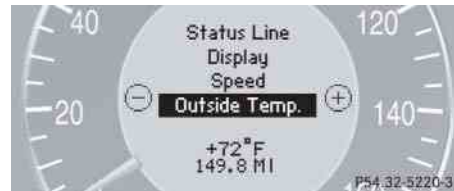

- ▶ Press button **+** or **-** to select the desired setting.

i You will see the status line when you have called up a different display from the standard display.

Selecting display (speed display or outside temperature) for standard display

- ▶ Move the selection marker with button **+** or **-** to the Instr. Cluster submenu.
 - ▶ Press button **▲** or **▼** repeatedly until the message Basic Display appears in the multifunction display.
- The selection marker is on the current setting.



- ▶ Press button **+** or **-** to select the display mode shown in the basic display.

Control system

Time/Date submenu

Access the Time/Date submenu via the Settings... menu. Use the Time/Date submenu to change the instrument cluster display settings.

The following functions are available:

Function	Page
Setting the time (hours)	160
Setting the time (minutes)	160
Setting the date (month)	161
Setting the date (day)	161
Setting the date (year)	162

i The Time/Date submenu is not shown in vehicles with COMAND*.

Setting time (hours)

This function can only be seen in vehicles with audio system.

i Vehicles with COMAND*: For information on setting the time in COMAND, refer to the separate COMAND operating instructions.

- ▶ Move the selection marker with button **+** or **-** to the Time/Date submenu.
- ▶ Press button **↶** or **↷** repeatedly until the message Time - Hours Press R To Confirm appears in the multifunction display.

The selection marker is on the hour setting.



- ▶ Press button **+** or **-** to set the hour.

- ▶ Press the reset button in the instrument cluster (▷ page 138) to confirm. The hour is set and stored.

Setting time (minutes)

This function can only be seen with audio system.

i Vehicles with COMAND*: For information on setting the time in COMAND, refer to the separate COMAND operating instructions.

- ▶ Move the selection marker with button **+** or **-** to the Time/Date submenu.
- ▶ Press button **↶** or **↷** repeatedly until the message Time - Minute(s) Press R To Confirm appears in the multifunction display.

The selection marker is on the minutes setting.



- ▶ Press button **+** or **-** to set the minutes.
- ▶ Press the reset button in the instrument cluster (▷ page 138) to confirm.

The minutes are set and stored.

Setting the date (month)

This function can only be seen with audio system.

i *Vehicles with COMAND*:*
For information on setting the date in COMAND, refer to the separate COMAND operating instructions.

- ▶ Move the selection marker with button **+** or **-** to the Time/Date submenu.
- ▶ Press button **↶** or **↷** repeatedly until the message Set Date Month appears in the multifunction display.

The selection marker is on the month setting.



- ▶ Press button **+** or **-** to set the month.

Setting the date (day)

This function can only be seen with audio system.

i *Vehicles with COMAND*:*
For information on setting the date in COMAND, refer to the separate COMAND operating instructions.

- ▶ Move the selection marker with button **+** or **-** to the Time/Date submenu.
- ▶ Press button **↶** or **↷** repeatedly until the message Set Date Day appears in the multifunction display.

The selection marker is on the day setting.



- ▶ Press button **+** or **-** to set the day.

Control system

Setting the date (year)

This function can only be seen with audio system.

i Vehicles with COMAND*:
For information on setting the date in COMAND, refer to the separate COMAND operating instructions.

- ▶ Move the selection marker with button **+** or **-** to the Time/Date submenu.
- ▶ Press button **↕** or **↓** repeatedly until the message Set Date Year appears in the multifunction display.

The selection marker is on the year setting.



- ▶ Press button **+** or **-** to set the year.

Lighting submenu

Access the Lighting submenu via the Settings... menu. Use the Lighting submenu to change the lamp and lighting settings on your vehicle.

The following functions are available:

Function	Page
Setting daytime running lamp mode (USA only)	162
Setting locator lighting	163
Setting night security illumination	164
Setting interior lighting delayed shut-off	165

Setting daytime running lamp mode (USA only)

i This function is not available in countries where the daytime running lamp mode is mandatory and therefore in a constant mode.

- ▶ Move the selection marker with button **+** or **-** to the Lighting submenu.
- ▶ Press button **↕** or **↓** repeatedly until the message Headlamp Mode appears in the multifunction display.

The selection marker is on the current setting.



- ▶ Press button **+** or **-** to select manual operation (Manual) or daytime running lamp mode (Constant).

With daytime running lamp mode activated and the exterior lamp switch in position **0** or **AUTO**, the low beam headlamps are switched on when the engine is running.

In low ambient light conditions the following lamps will switch on additionally:

- Parking lamps
- Tail lamps
- License plate lamps
- Side marker lamps

For more information on the daytime running lamp mode, see “Lighting” (▷ page 129).

i For safety reasons, resetting the Lighting submenu to factory settings (▷ page 156) while driving will not deactivate the daytime running lamp mode.

The following message appears in the multifunction display:

Cannot be completely reset to factory settings while driving.

Setting locator lighting

With the locator lighting feature activated and the exterior lamp switch in position **AUTO**, the following lamps will switch on during darkness when the vehicle is unlocked using button **U** on the SmartKey or SmartKey with KEYLESS-GO*:

- Parking lamps
- Tail lamps
- License plate lamps
- Side marker lamps
- Front fog lamps

The locator lighting switches off when the driver’s door is opened.

If you do not open a door after unlocking the vehicle with the SmartKey, the lamps will switch off automatically after approximately 40 seconds.

- ▶ Move the selection marker with button **+** or **-** to the Lighting submenu.

- ▶ Press button **▲** or **▼** repeatedly until the message Surround Light. Function appears in the multifunction display.

The selection marker is on the current setting.



- ▶ Press button **+** or **-** to switch the locator lighting function On or Off
- ▶ Turn the exterior lamp switch to position **AUTO** when exiting the vehicle.

The locator lighting feature is activated.

Control system

Setting night security illumination (Headlamps delayed shut-off feature)

Use this function to set whether you would like the exterior lamps to remain on for 15 seconds during darkness after exiting the vehicle and closing all doors.

With the headlamps delayed shut-off feature activated and the exterior lamp switch in position **AUTO** before the engine is turned off, the following lamps will switch on when the engine is turned off:

- Parking lamps
- Tail lamps
- License plate lamps
- Side marker lamps
- Front fog lamps

If after turning off the engine you do not open a door or do not close an opened door, the lamps will automatically switch off after 60 seconds.

- ▶ Move the selection marker with button **+** or **-** to the Lighting submenu.
- ▶ Press button **↶** or **↷** repeatedly until the message Headlamps Delayed Shut-off appears in the multifunction display.

The selection marker is on the current setting.



- ▶ Press button **+** or **-** to switch the headlamps delayed shut-off feature On or Off.
- ▶ Turn the exterior lamp switch to position **AUTO** before turning off the engine.

The headlamps delayed shut-off feature is activated.

You can temporarily deactivate the headlamps delayed shut-off feature:

- ▶ Before exiting the vehicle, turn the SmartKey in the starter switch to position **0**.
- ▶ Then turn it to position **2** and back to **0**.

The headlamps delayed shut-off feature is deactivated. It will reactivate as soon as you reinsert the SmartKey in the starter switch.

Vehicles with KEYLESS-GO*:

- ▶ Press the KEYLESS-GO start/stop button on the gear selector lever (▷ page 40).

Setting interior lighting delayed shut-off

Use this function to set whether you would like the interior lighting to remain on for 10 seconds during darkness after you have removed the SmartKey from the starter switch.

- ▶ Move the selection marker with button **+** or **-** to the Lighting submenu.
- ▶ Press button **▲** or **▼** repeatedly until the message Interior Lighting Delayed Shut-off appears in the multifunction display.

The selection marker is on the current setting.



- ▶ Press button **+** or **-** to switch the interior lighting delayed shut-off feature On or Off.

Vehicle submenu

Access the Vehicle submenu via the Settings... menu. Use the Vehicle submenu to make general vehicle settings.

The following functions are available:

Function	Page
Selecting audio search function	165
Setting automatic locking	166

Selecting audio search function

Use of the Audio Search Function to select a radio station (▷ page 151) will enable you to start a frequency scan (Frequenc.) or select a radio station stored in memory (Memory).

- ▶ Move the selection marker with button **+** or **-** to the Vehicle submenu.
- ▶ Press button **▲** or **▼** repeatedly until the message Audio Search Function appears in the multifunction display.

The selection marker is on the current setting.



- ▶ Press button **+** or **-** to set the audio search function to Frequenc. or Memory.

To select a radio station, see “Selecting radio station” (▷ page 151).

Control system

Setting automatic locking

Use this function to activate or deactivate the automatic central locking. With the automatic central locking system activated, the vehicle is centrally locked at vehicle speeds of approximately 9 mph (15 km/h).

- ▶ Move the selection marker with button **+** or **-** to the Vehicle submenu.
- ▶ Press button **▲** or **▼** repeatedly until the message Automatic Door Locking appears in the multifunction display.

The selection marker is on the current setting.



- ▶ Press button **+** or **-** to switch the automatic central locking On or Off.

Convenience submenu

Access the Convenience submenu via the Settings... menu. Use the Convenience submenu to change the settings for the easy-entry/exit convenience feature.

Function	Page
Activating easy-entry/exit feature	166

Activating easy-entry/exit feature

Use this function to activate and deactivate the easy-entry/exit feature (▷ page 45).

Warning!



You must make sure no one can become trapped or injured by the moving steering wheel when the easy-entry/exit feature is activated.

To stop steering wheel movement, do one of the following:

- Move steering wheel adjustment stalk (▷ page 45).
- Press the memory position switch (▷ page 128).

Do not leave children unattended in the vehicle, or with access to an unlocked vehicle. Children could open the driver's door and unintentionally activate the easy-entry/exit feature, which could result in an accident and/or serious personal injury.

- ▶ Move the selection marker with button **+** or **-** to the Convenience submenu.
- ▶ Press button **▲** or **▼** repeatedly until the message Easy-entry Function appears in the multifunction display.

The selection marker is on the current setting.



- ▶ Press button **+** or **-** to switch the easy-entry/exit feature On or Off.

Trip computer menu

Use the trip computer menu to call up statistical data on your vehicle.

The following information is available:

Function	Page
Fuel consumption statistics since start	167
Fuel consumption statistics since last reset	168
Resetting fuel consumption statistics	168
Distance to empty	168

Fuel consumption statistics since start

- ▶ Press button **☰** or **☷** repeatedly until the first function of the trip computer menu appears in the multifunction display.
- ▶ Press button **▲** or **▼** repeatedly until the message From Start appears in the multifunction display.







- ① Distance driven since start
- ② Time elapsed since start
- ③ Average speed since start
- ④ Average fuel consumption since start

i All statistics stored from the last engine start will be reset approximately four hours after the SmartKey in the starter switch is turned to position 0 or removed from the starter switch.

Resetting will not occur if you turn the SmartKey back to position 1 or 2 within this time period.

Control system



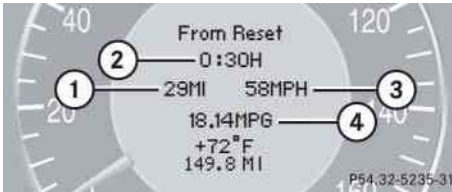

Fuel consumption since last reset

- ▶ Press button  or  repeatedly until the first function of the trip computer menu appears in the multifunction display.
- ▶ Press button  or  repeatedly until the message **From Reset** appears in the multifunction display.







- ① Distance driven since last reset
- ② Time elapsed since last reset
- ③ Average speed since last reset
- ④ Average fuel consumption since last reset

Resetting fuel consumption statistics

- ▶ Press button  or  repeatedly until the first function of the trip computer menu appears in the multifunction display.
- ▶ Press button  or  repeatedly until the reading that you want to reset appears in the multifunction display.
- ▶ Press and hold the reset button in the instrument cluster (▷ page 138) until the value is reset to 0.

Distance to empty

- ▶ Switch on the ignition (▷ page 40).
- ▶ Press button  or  repeatedly until the first function of the trip computer menu appears in the multifunction display.
- ▶ Press button  or  repeatedly until the message **Range :** appears in the multifunction display.

The calculated remaining driving range based on the current fuel tank level appears in the multifunction display. If the remaining fuel in the tank is sufficiently low, a fuel pump is shown instead of the range.

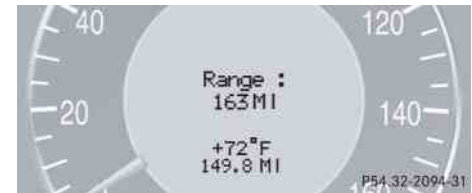

TEL* menu

Warning!



A driver's attention to the road must always be his/her primary focus when driving. For your safety and the safety of others, we recommend that you pull over to a safe location and stop before placing or taking a telephone call. If you choose to use the telephone while driving, please use the hands-free device and only use the telephone when weather, road and traffic conditions permit.

Some jurisdictions prohibit the driver from using a cellular telephone while driving a vehicle.

Bear in mind that at a speed of just 30 mph (approximately 50 km/h), your vehicle is covering a distance of 44 feet (approximately 14 m) every second.

Never operate radio transmitters equipped with a built-in or attached antenna (i.e. without being connected to an external antenna) from inside the vehicle while the engine is running. Doing so could lead to a malfunction of the vehicle's electronic system, possibly resulting in an accident and /or personal injury.

You can use the functions in the Tel menu to operate your telephone, provided it is connected to a hands-free system and switched on.

- ▶ Switch on the telephone and audio or COMAND*.
- ▶ Press button  or  on the steering wheel repeatedly until the message Tel appears in the multifunction display.

Which messages will appear in the multifunction display depends on whether your telephone is switched on or off:

- If the telephone is off, the message Tel Off appears in the multifunction display.

Control system

- If the telephone is on:

The telephone will then search for a network. During this time the multifunction display is empty.

As soon as the telephone has found a network, the message **READY** appears in the multifunction display.

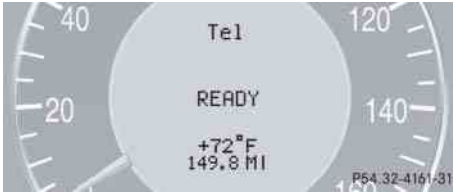

This standby message indicates that your telephone is ready for use and you can operate it using the control system.

Answering a call

When your telephone is ready to receive calls, you can answer a call at any time. In the multifunction display you will see the message, or if available, the caller ID (name and number):



- ▶ Press button .





You have answered the call. The duration of the call appears in the multifunction display.

Ending a call or rejecting an incoming call

- ▶ Press button .



Dialing a number from the phone book

If your telephone is ready to receive calls, you may select and dial a number from the phone book at any time.

- ▶ Press button  or  repeatedly until the message **Tel** appears in the multifunction display.
- ▶ Press button  or .

The control system reads the phone book which is stored in the telephone. This may take several minutes. The message **Please Wait** appears in the multifunction display.



When the message **Please Wait** disappears, the phone book has been loaded.

- ▶ Press button  or  repeatedly until the desired name appears in the multifunction display.

The stored names are displayed in ascending or descending alphabetical order.



① Name from phone book

i If you press and hold button  or  for longer than one second, the system scrolls rapidly through the list of names until you release the button again.

Cancel the quick search mode by pressing .

- ▶ Press button .

The system dials the selected phone number.

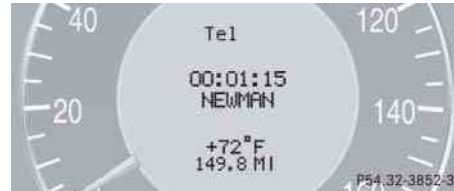

- If the connection is successful and this feature is supported by your network provider, the name of the party you are calling (if stored in your phone book) and the duration of the call will appear in the multifunction display.



- If no connection is made, the control system stores the dialed number in the redial memory.



Redialing

The control system stores the most recently dialed phone numbers. This eliminates the need to search through your entire phone book.

- ▶ Press button  or  repeatedly until the message Te1 appears in the multifunction display.

- ▶ Press button .

The first number in the redial memory appears in the multifunction display.

- ▶ Press button  or  repeatedly until the desired name appears in the multifunction display.

i If you do not want to use the telephone, press button .

- ▶ Press button .

The control system dials the selected phone number.

Automatic transmission

For more information on driving with an automatic transmission, see “Automatic transmission” (▷ page 51).

Your vehicle’s transmission adapts its gear shifting process to your individual driving style by continually adjusting the shift points up or down. These shift point adjustments are performed based on current operating and driving conditions.

If the operating conditions change, the automatic transmission reacts by adjusting its shift program.

i *During the brief warm-up, transmission upshifting is delayed. This allows the catalytic converter to heat up more quickly to operating temperature.*

Warning!



Make sure absolutely no objects are obstructing the pedals’ range of movement. Keep the driver’s footwell clear of all obstacles. If there are any floor mats or carpets in the footwell, make sure the pedals still have sufficient clearance.

During sudden driving or braking maneuvers the objects could get caught between or beneath the pedals. You could then no longer brake or accelerate. This could lead to accidents and injury.

Gear selector lever

The gear selector lever is located on the lower part of the center console.

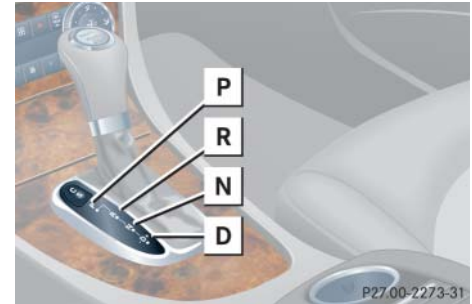

Gearshift pattern for automatic transmission

- P** Park position
- R** Reverse gear
- N** Neutral
- D** Drive position

i *The current gear selector lever position **P**, **R**, **N** or **D** appears in the multifunction display (▷ page 174).*

Warning!

It is dangerous to shift the gear selector lever out of park position **P** or neutral position **N** if the engine speed is higher than idle speed. If your foot is not firmly on the brake pedal, the vehicle could accelerate quickly forward or reverse. You could lose control of the vehicle and hit someone or something. Only shift into gear when the engine is idling normally and when your right foot is firmly on the brake pedal.

An additional indication of the current gear selector lever position can be found on the cover of the shifting-gate.

The indicators come on when you activate a switch (e.g. unlocking the vehicle or opening a door) and go out after approximately 15 minutes.

Shifting procedure

The automatic transmission selects individual gears automatically, depending on:

- gear selector lever position **D**
(▷ page 174) with gear ranges
(▷ page 177)
- the selected program mode (**C/S**)
(▷ page 178)
- or
(M/C/S) (CLK 63 AMG only)
(▷ page 182)
- the position of the accelerator pedal
(▷ page 176)
- the vehicle speed

! Allow engine to warm up under low load use. Do not place full load on the engine until the operating temperature has been reached.

Shift into reverse gear **R** or park position **P** only when the vehicle is stopped.

Avoid spinning of a drive wheel when driving off on slippery road surfaces. This may cause serious damage to the drivetrain which is not covered by the Mercedes-Benz Limited Warranty.

When the gear selector lever is in drive position **D**, you can influence transmission shifting by:

- limiting the gear range
- changing gears manually

Automatic transmission

Gear selector lever positions

The current gear selector lever position appears in the multifunction display.



① Current gear selector lever position

Effect

P Park position

Gear selector lever position when the vehicle is parked. Place gear selector lever in park position **P** only when vehicle is stopped. The park position is not intended to serve as a brake when the vehicle is parked.

Rather, the driver should always set the parking brake in addition to placing the gear selector lever in park position **P** to secure the vehicle.

Effect

The SmartKey can only be removed from the starter switch with the gear selector lever in park position **P**. With the SmartKey removed, the gear selector lever is locked in park position **P**.

If the vehicle's electrical system is malfunctioning, the gear selector lever could remain locked in park position **P** (▷ page 429).

R Reverse gear

Place gear selector lever in position **R** only when vehicle is stopped.

	Effect
N	<p>Neutral</p> <p>No power is transmitted from the engine to the drive axle. When the brakes are released, the vehicle can be moved freely (pushed or towed).</p> <p>To avoid damage to the transmission, never engage neutral position N while driving.</p> <p>If the ESP® is deactivated or malfunctioning: Move gear selector lever to neutral position N only if the vehicle is in danger of skidding, e.g. on icy roads.</p>
D	<p>Drive</p> <p>The transmission shifts automatically. All forward gears are available.</p>

! *Coasting the vehicle, or driving for any other reason with gear selector lever in neutral position **N** can result in transmission damage that is not covered by the Mercedes-Benz Limited Warranty.*

Warning!



Getting out of your vehicle without shifting into park position **P** is dangerous. Also, park position **P** alone is not intended to or capable of preventing your vehicle from moving, possibly hitting people or objects.

Always set the parking brake (▷ page 59) in addition to shifting to park position **P**.

When parked on an incline, turn the front wheels towards the road curb.

Do not park this vehicle in areas where combustible materials such as grass, hay or leaves can come into contact with the hot exhaust system, as these materials could be ignited and cause a vehicle fire.

Warning!



When leaving the vehicle, always remove the SmartKey or SmartKey with KEYLESS-GO* from the starter switch, take it with you, and lock the vehicle. Do not leave children unattended in the vehicle, or with access to an unlocked vehicle. Children could move the gear selector lever from park position **P**, which could result in an accident and/or serious personal injury.

Getting out of your vehicle without taking the above measurements to secure it is dangerous.

Automatic transmission

Driving tips

Accelerator position

Your driving style influences the transmission's shifting behavior:

Less throttle	Earlier upshifting
More throttle	Later upshifting

Kickdown

Use kickdown when you want maximum acceleration.

- ▶ Press the accelerator past the point of resistance.
Depending on the engine speed the transmission shifts into a lower gear.
- ▶ Ease on the accelerator when you have reached the desired speed.
The transmission shifts up again.

Stopping

When you stop briefly, e.g. at traffic lights:

- ▶ Leave the transmission in gear.
- ▶ Hold the vehicle with the brake.

When you stop for a longer period of time with the engine idling and/or on a hill:

- ▶ Set the parking brake.
- ▶ Move the gear selector lever to park position **P**.

Maneuvering

When you maneuver in tight areas, e.g. when pulling into a parking space:

- ▶ Control the vehicle speed by gradually releasing the brakes.
- ▶ Accelerate gently.
- ▶ Never abruptly step on the accelerator.

Working on the vehicle

Warning!



When working on the vehicle, set the parking brake and move gear selector lever to park position **P**. Otherwise the vehicle could roll away.

Gear ranges

With the gear selector lever in drive position **D** and driving in program mode **C** or **S** (▷ page 178), you can select a gear range for the automatic transmission to operate within.

Gear selector lever (▷ page 179):

You can limit the gear range by pressing the gear selector lever to the left (**D-**), and reverse the gear range limit by pressing the gear selector lever to the right (**D+**).

Steering wheel gearshift control* (▷ page 180):

You can limit the gear range by pulling the left gearshift paddle on the steering wheel gearshift control, and reverse the gear range limit by pulling the right gearshift paddle on the steering wheel gearshift control.

The selected gear range appears in the multifunction display.



① Current gear range

	Effect
6	The transmission shifts through sixth gear only.
5	The transmission shifts through fifth gear only.
4	The transmission shifts through fourth gear only.

	Effect
3	The transmission shifts through third gear only. With this selection you can use the braking effect of the engine.
2	The transmission shifts through second gear only. Allows the use of engine's braking power when driving <ul style="list-style-type: none"> • on steep downgrades • in mountainous regions • under extreme operating conditions
1	The transmission operates in first gear only. For maximum use of engine's braking effect on very steep or lengthy downgrades.

Automatic transmission

Automatic shift program

The program mode selector switch is located on the lower part of the center console.



Program mode selector switch

- C** Comfort For comfort driving
- S** Sport For standard driving



Program mode selector switch (CLK 63 AMG only)

- M** Manual For manual gear shifting (▷ page 182)
- C** Comfort For standard driving
- S** Sport For sporty driving

The selected program mode appears in the multifunction display.



- ① Selected program mode (comfort, sport, or manual (CLK 63 AMG only))

! Never change the program mode when the gear selector lever is out of park position **P**. This could result in a change of driving characteristics for which you may not be prepared.

i The last selected program mode (**C** or **S**) is switched on when the engine is restarted.

- ▶ Press program mode selector switch repeatedly until the letter of the desired program mode appears in the multifunction display.

Select **C** for comfort driving (CLK 63 AMG: for standard driving):

- The vehicle starts out in second gear (both forward and reverse) for gentler starts. This does not apply if full throttle is applied or gear range **1** is selected.
- Traction and driving stability are improved on icy roads.
- Upshifts occur earlier even when you give more gas. The engine then operates at lower rpms and the wheels are less likely to spin.

Select **S** for standard driving (CLK 63 AMG: for sporty driving):

- The vehicle starts out in first gear.
- Upshifts occur later.

Gear selector lever one-touch gearshifting

With the gear selector lever in drive position **D** and driving in program mode **C** or **S**, you can limit or extend the gear range.

If your vehicle is equipped with manual shift program **M**, you can use the gear selector lever to manually shift the gears.

 For information on using the gear selector lever in program mode **M**, see “Manual shift program CLK 63 AMG” (▷ page 182).

 Allow engine to warm up under low load use. Do not place full load on the engine until the operating temperature has been reached.

Shift into reverse gear **R** or park position **P** only when the vehicle is stopped.

Avoid spinning of a drive wheel when driving off on slippery road surfaces. This may cause serious damage to the drivetrain which is not covered by the Mercedes-Benz Limited Warranty.

The following instructions describe operation of the gear selector lever when driving in the automatic program mode **C** or **S**.

Limiting gear range

Warning!



On slippery road surfaces, never downshift in order to obtain braking action. This could result in drive wheel slip and reduced vehicle control. Your vehicle's ABS will not prevent this type of loss of control.

- ▶ Briefly press the gear selector lever to the left in the **D**- direction.

The transmission will shift to the next lower gear as permitted by the shift program. This action simultaneously limits the gear range of the transmission (▷ page 177).

 To avoid overrevving the engine when downshifting, the transmission will not shift to a lower gear if the engine's max. speed would be exceeded.

Automatic transmission

Extending gear range

- ▶ Briefly press the gear selector lever to the right in the **D+** direction.

The transmission will shift to the next higher gear as permitted by the shift program. This action simultaneously extends the gear range of the transmission.

i *If you press on the accelerator when the engine has reached its rpm limit, the transmission will upshift beyond any gear range limit selected.*

Canceling gear range limit

- ▶ Press and hold the gear selector lever in the **D+** direction until **D** reappears in the multifunction display (▷ page 174).

The transmission will shift from the current gear range directly to gear range **D**.

Shifting into optimal gear range

- ▶ Press and hold the gear selector lever in the **D-** direction.

The transmission will automatically select the gear range suited for optimal acceleration and deceleration. This will involve shifting down one or more gears.

Steering wheel gearshift control one-touch gearshifting*

With the gear selector lever in drive position **D** and driving in program mode **C** or **S**, you can limit or extend the gear range.

If your vehicle is equipped with manual shift program **M**, you can use the steering wheel gearshift control to manually shift the gears.

i *For information on using the steering wheel gearshift control in program mode **M**, see “Manual shift program CLK 63 AMG” (▷ page 182).*

! *Allow engine to warm up under low load use. Do not place full load on the engine until the operating temperature has been reached.*

*Shift into reverse gear **R** or park position **P** only when the vehicle is stopped.*

Avoid spinning of a drive wheel when driving off on slippery road surfaces. This may cause serious damage to the drivetrain which is not covered by the Mercedes-Benz Limited Warranty.

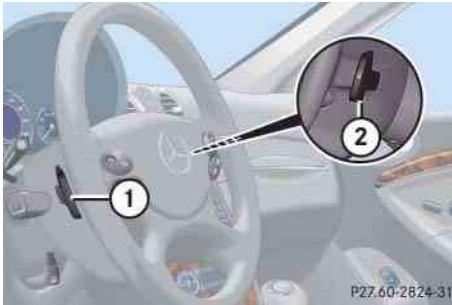

Gearshift paddles (example illustration CLK 550)

- ① Left shift paddle: limiting gear range or downshift (in program mode **M**)
- ② Right shift paddle: extending gear range or upshift (in program mode **M**)

i You cannot shift with the steering wheel gearshift paddles when the gear selector lever is in position **P**, **N** or **R**.

The following instructions describe operation of the steering wheel gearshift control when driving in the automatic program mode **C** or **S**.

Limiting gear range

Warning!



On slippery road surfaces, never downshift in order to obtain braking action. This could result in drive wheel slip and reduced vehicle control. Your vehicle's ABS will not prevent this type of loss of control.

- ▶ Briefly pull left shift paddle ①.

The transmission will shift to the next lower gear as permitted by the shift program. This action simultaneously limits the gear range of the transmission (▷ page 177).

i To avoid overrevving the engine when downshifting, the transmission will not shift to a lower gear if the engine's max. speed would be exceeded.

Extending gear range

- ▶ Briefly pull right shift paddle ②.

The transmission will shift to the next higher gear as permitted by the shift program. This action simultaneously extends the gear range of the transmission.

i If you press on the accelerator when the engine has reached its rpm limit, the transmission will upshift beyond any gear range limit selected.

Canceling gear range limit

- ▶ Pull and hold right shift paddle ② until **D** reappears in the multifunction display (▷ page 174).

The transmission will shift from the current gear range directly to gear **D**.

Automatic transmission

Shifting into optimal gear range

- ▶ Pull and hold left shift paddle ①.

The transmission will automatically select the gear range suited for optimal acceleration and deceleration. This will involve shifting down one or more gears.

Manual shift program CLK 63 AMG

In addition to the automatic shift program **C** or **S**, your vehicle is equipped with the manual shift program **M**.

In the manual program mode **M**, system-controlled automatic gearshifting is switched off and you need to change the gears by manually upshifting or downshifting using the steering wheel gearshift paddles (▷ page 181) or the gear selector lever.

! Allow engine to warm up under low load use. Do not place full load on the engine until the operating temperature has been reached.

Shift into reverse gear **R** or park position **P** only when the vehicle is stopped.

Avoid spinning of a drive wheel when driving off on slippery road surfaces. This may cause serious damage to the drivetrain which is not covered by the Mercedes-Benz Limited Warranty.

The program mode selector switch is located on the lower part of the center console.



Program mode selector switch

M Manual	For manual gear shifting
C Comfort	For standard driving
S Sport	For sporty driving

The selected program mode appears in the multifunction display (▷ page 178).

i For information on automatic program modes **C** or **S**, see “Automatic shift program” (▷ page 178), “Gear selector lever one-touch gearshifting” (▷ page 179), and “Steering wheel gearshift control one-touch gearshifting*” (▷ page 180).

Activating manual shift program

▶ Press program mode selector switch repeatedly until the **M** for manual program mode **M** appears in the multifunction display.

The transmission switches to the manual program mode **M**. Automatic shifting is switched off. The gear range is not limited.

You can change the gears manually when the gear selector lever is in drive position **D**. You can upshift or downshift through the gears in succession.

i The manual program mode **M** will not be stored. When the engine is turned off with the manual program mode **M** selected, the transmission will go to the automatic program mode (**C** or **S**) when the engine is restarted.

Upshifting

! In the manual program mode **M**, the transmission will not upshift, even if the engine has reached its overrevving range. Shift up to the next gear before the engine has reached its overrevving range. Make absolutely certain that the engine speed does not reach the red marking on the tachometer (▷ page 28). Otherwise the engine could be damaged which is not covered by the Mercedes-Benz Limited Warranty.

▶ Briefly press the gear selector lever to the right in the **D+** direction.

or

▶ Briefly pull right shift paddle ② (▷ page 181).

The transmission shifts to the next higher gear.

If, instead of the manual program mode symbol **M**, the  symbol appears in the multifunction display (▷ page 178), shift to the next higher gear. The fuel supply will otherwise be interrupted to prevent the engine from overrevving.

If you are driving in the manual program mode **M**, upshift indicator ② in the multifunction display advises you to upshift before the engine reaches the overspeed range. Thus you can drive at the maximum engine speed for each gear without overrevving the engine.



- ① Gear indicator
- ② Upshift indicator



Automatic transmission

- ▷▷ Shift to the next higher gear.

The fuel supply will otherwise be interrupted to prevent the engine from over-revving.

Downshifting

Warning!



On slippery road surfaces, never downshift in order to obtain braking action. This could result in drive wheel slip and reduced vehicle control. Your vehicle's ABS will not prevent this type of loss of control.

- ▶ Briefly press the gear selector lever to the left in the **D**- direction.

or

- ▶ Briefly pull left shift paddle ① (▷ page 181).

The transmission shifts to the next lower gear.

i When you brake or stop, the transmission shifts down to a gear from which you can easily accelerate or take off.

Kickdown

Using the kickdown when driving in the manual program mode **M** is not possible.

Deactivating manual shift program

- ▶ Press the program mode selector switch (▷ page 182) repeatedly until **C** or **S** appears in the multifunction display.

or

- ▶ Restart the engine.

The transmission will go to the automatic program mode (**C** or **S**).

The manual program mode **M** is not stored.

Emergency operation (Limp-Home Mode)

If vehicle acceleration becomes less responsive or sluggish or the transmission no longer shifts, the transmission is most likely operating in limp-home (emergency operation) mode. In this mode only second gear and reverse gear can be selected.

- ▶ Stop the vehicle in a safe location.
- ▶ Move the gear selector lever to park position **P**.
- ▶ Turn off the engine.
- ▶ Wait at least 10 seconds before restarting.
- ▶ Restart the engine.
- ▶ Move the gear selector lever to position **D** (for second gear) or position **R**.
- ▶ Have the transmission checked at an authorized Mercedes-Benz Center as soon as possible.

▼ **Good visibility**

For information on the windshield wipers, see “Windshield wipers” (▷ page 56).

Headlamp cleaning system*

The button is located on the left side of the dashboard.



① Headlamp washer button

- ▶ Switch on the ignition (▷ page 40).
- ▶ Press button ①.

The headlamps are cleaned with a high-pressure water jet.

i *The headlamps will automatically be cleaned when you have*

- *switched on the headlamps and*
- *operated the windshield wipers with windshield washer fluid fifteen times*

When you switch off the ignition, the counter resets.

For information on filling up the washer reservoir, see “Windshield washer system and headlamp cleaning system*” (▷ page 496).

Rear view mirrors

For more information on setting the rear view mirrors, see “Mirrors” (▷ page 47).

Interior rear view mirror, antiglare position

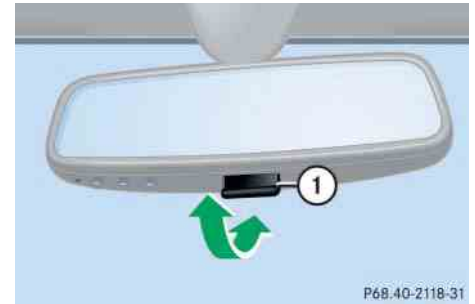

① Lever

- ▶ Tilt the mirror to the antiglare position by moving lever ① towards the windshield.

The interior rear view mirror is dimmed.

Good visibility

Auto-dimming rear view mirrors*

The reflection brightness of the exterior rear view mirror on the driver's side and the interior rear view mirror will respond automatically to glare when

- the ignition is switched on (> page 40), and
- incoming light from headlamps falls on the sensor in the interior rear view mirror.

The rear view mirror will not react if

- reverse gear **R** is engaged
- the interior lighting is turned on

Warning!



The auto-dimming function does not react if incoming light is not aimed directly at sensors in the interior rear view mirror.

The interior rear view mirror and the exterior rear view mirror on the driver's side do not react, for example, if the rear window sun shade* is in raised position, or if the wind screen is installed.

Light hitting the mirror(s) at certain angles (incident light) could blind you. As a result, you may not be able to observe traffic conditions and could cause an accident.

Warning!



Exercise care when using the passenger-side exterior rear view mirror. The mirror surface is convex (outwardly curved surface for a wider field of view). Objects in mirror are closer than they appear. Check your interior rear view mirror or glance over your shoulder before changing lanes.

Sun visors

The sun visors protect you from sun glare while driving.

Warning!



Do not use the vanity mirror while driving.

Keep the vanity mirror in the sun visors closed while vehicle is in motion. Reflected glare can endanger you and others.

- ▶ Swing sun visor ④ down when you experience glare.

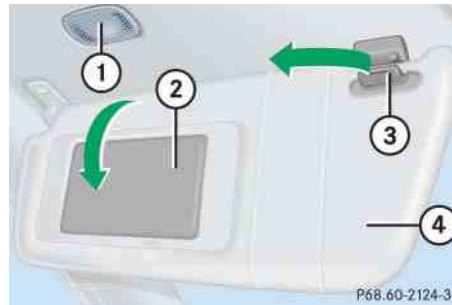

- ① Vanity mirror lamp
- ② Vanity mirror cover
- ③ Mounting
- ④ Sun visor

- ▶ To use the illuminated vanity mirror, lift up vanity mirror cover ②.

i If sun visor ④ is disengaged from mounting ③ with vanity mirror cover ② open, vanity mirror lamp ① will switch off.

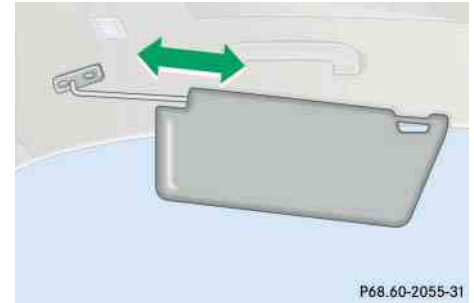

If sunlight enters through a side window:

- ▶ Disengage sun visor from mounting ③.
- ▶ Pivot sun visor to the side.

The sun visors are extendable.

- ▶ Adjust the sun visors by pushing or pulling in the direction of the arrows.

! Close vanity mirror cover ② (if open) before you disengage the sun visor ④ from mounting ③ and pivot it to the side.

Good visibility

Rear window sunshade* (CLK coupe: Canada only)

The switch is located in the center console.

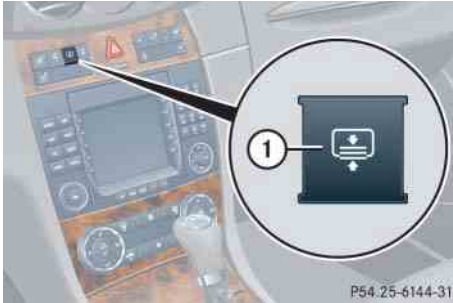

① Rear window sunshade switch

! Make sure the movement of the rear window sunshade is not restricted by objects on the rear window shelf. Otherwise, the sunshade or the objects could be damaged.

- ▶ Switch on the ignition (▷ page 40).

Always raise the sunshade fully for its support against the window frame.

Raising the sunshade

- ▶ Press switch ① briefly.
The sunshade is raised completely.

Stopping the raising procedure

- ▶ Press switch ① again.
The sunshade stops.

Lowering the sunshade

- ▶ Press switch ① briefly.
The sunshade is lowered completely.

Stopping the lowering procedure

- ▶ Press switch ① again.
The sunshade stops.

Warning!



When operating the rear window sunshade, make sure there is no danger of anyone being harmed by the raising or lowering procedure.

The raising or lowering procedure can be immediately halted by briefly pressing the switch ①.

Briefly press switch ① again to raise or lower the rear window sunshade completely.

Warning!



When leaving the vehicle, always remove the SmartKey or SmartKey with KEYLESS-GO* from the starter switch, take it with you, and lock the vehicle. Do not leave children unattended in the vehicle, or with access to an unlocked vehicle. Unsupervised use of vehicle equipment may cause an accident and/or serious personal injury.

Rear window defroster

The rear window defroster uses a large amount of power. To keep the battery drain to a minimum, switch off the defroster as soon as the rear window is clear. The defroster is automatically deactivated after approximately 6 to 17 minutes of operation depending on the outside temperature.



- ▶ Switch on the ignition (▷ page 38).

Warning!



Any accumulation of snow and ice should be removed from the rear window before driving. Visibility could otherwise be impaired, endangering you and others.

Activating

- ▶ Press button  or  in the climate control panel (▷ page 191) or automatic climate control panel (▷ page 201).

The indicator lamp on the button comes on.

Deactivating

- ▶ Press button  or  again.

The indicator lamp on the button goes out.

! *If the rear window defroster switches off too soon and the indicator lamp starts flashing, this means that too many electrical consumers are operating simultaneously and there is insufficient voltage in the battery. The system responds automatically by deactivating the rear window defroster.*

As soon as the battery has sufficient voltage, the rear window defroster automatically switches on again.

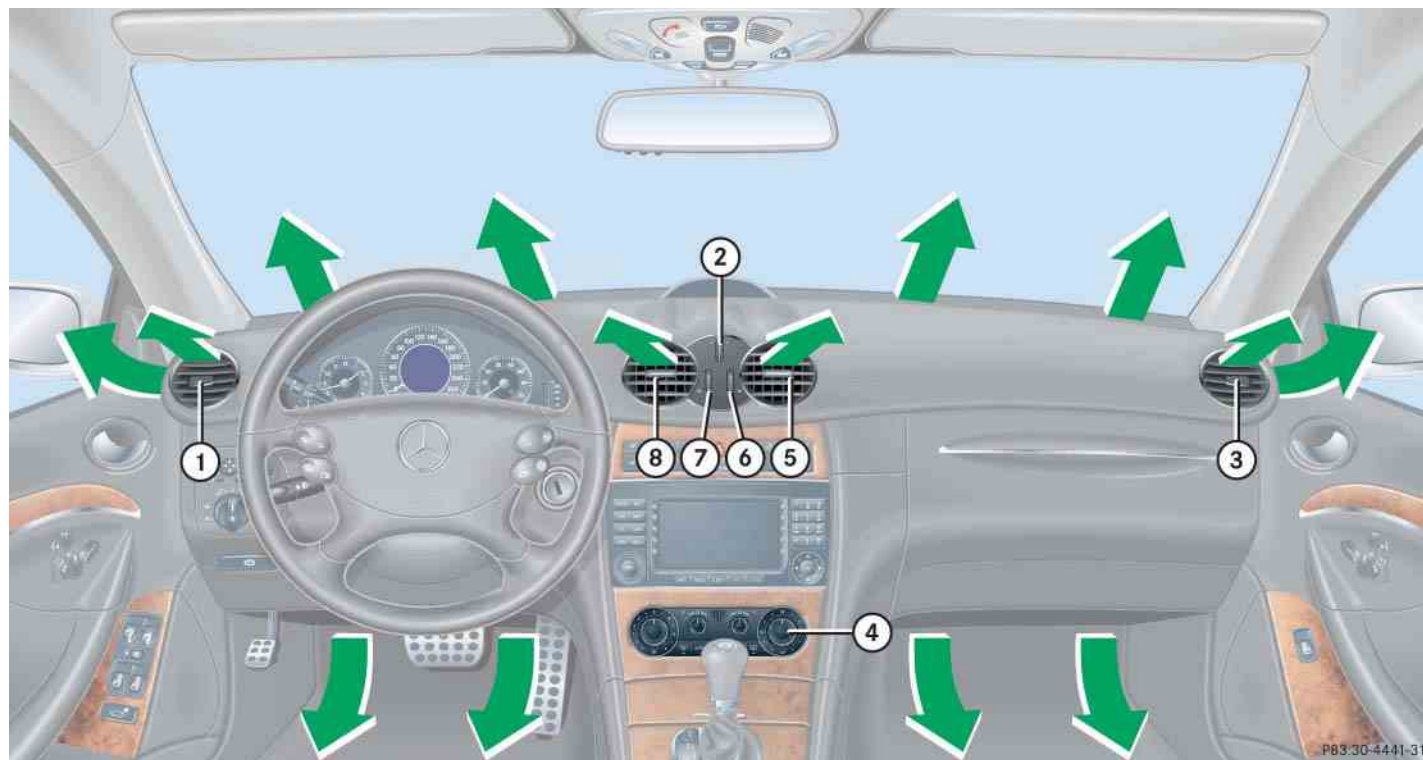

CLK 350 Canada

Item
① Left side air vent, adjustable
② Thumbwheel for air volume control for center air vents
③ Right side air vent, adjustable
④ Climate control panel
⑤ Right center air vent, adjustable
⑥ Thumbwheel for air volume control for right side center air vent
⑦ Thumbwheel for air volume control for left side center air vent
⑧ Left center air vent, adjustable



Item
① Air volume control
② Left side temperature control
③ Right side temperature control
④ Air distribution control
⑤ Rear window defroster
⑥ AC cooling on/off
⑦ Air distribution and air volume (automatic mode)
⑧ Air recirculation
⑨ Front defroster

i For draft-free ventilation, move the sliders for the side air vents and center air vents to the middle position.

Climate control

The climate control is operational whenever the engine is running. You can operate the climate control system in either the automatic or manual mode. The system cools or heats the interior depending on the selected interior temperature and the current outside temperature.

Warning!



When operating the climate control, the air that enters the passenger compartment through the air vents can be very hot or very cold (depending on the set temperature). This may cause burns or frostbite on unprotected skin in the immediate area of the air vents. Always keep sufficient distance between unprotected parts of the body and the air vents. If necessary, use the air distribution control (▷ page 191) to direct the air to air vents in the vehicle interior that are not in the immediate area of unprotected skin.

Nearly all dust particles, pollutants and odors are filtered out before outside air enters the passenger compartment through the air distribution system.

Warning!



Severe conditions (e.g. strong air pollution) may require replacement of the filter before its scheduled replacement interval. A clogged filter will reduce the air volume to the interior and the windows could fog up, impairing visibility and endangering you and others. Have a clogged filter replaced as soon as possible at an authorized Mercedes-Benz Center.

The air conditioning will not engage (no cooling) if the **A/C** mode is deactivated (▷ page 198).

Warning!



Follow the recommended settings for heating and cooling given on the following pages. Otherwise the windows could fog up, impairing visibility and endangering you and others.

i *Keep the air intake grille in front of the windshield free of snow and debris.*

Do not obstruct air flow by placing objects on the air flow-through exhaust slots below the rear window.

i *If the vehicle interior is hot, ventilate the interior before driving off, see “Summer opening feature” (▷ page 253). The climate control will then adjust the interior temperature to the set value much faster.*

Deactivating the climate control system

Warning!



When the climate control is switched off, the outside air supply and circulation are also switched off. Only choose this setting for a short time. Otherwise the windows could fog up, impairing visibility and endangering you and others.

Deactivating

- ▶ Set air volume control ① (▷ page 191) to position **0**.

Reactivating

- ▶ Make sure the ignition is switched on.
- ▶ Set air volume control ① (▷ page 191) to any speed.

The previous settings are once again in effect.

Operating the climate control system in automatic mode

i When operating the climate control system in automatic mode, you will only rarely need to adjust the temperature, air volume and air distribution.

*In automatic mode, the dehumidify function is switched on when the system is cooling. If necessary, this function can be switched off by pushing the **A/C** button.*

Activating

- ▶ Press button **AUTO** (▷ page 191) while the engine is running.

The indicator lamp on the button comes on. The air volume and air distribution are adjusted automatically.

- ▶ Use temperature controls ② and ③ (▷ page 191) to separately adjust the air temperature on each side of the passenger compartment.

The temperature of the vehicle interior is adjusted automatically.

Deactivating

- ▶ Press button **AUTO** (▷ page 191) again.

The indicator lamp on the button goes out. The automatic operation of air volume and air distribution switches off.

Climate control

Setting the temperature

Use temperature controls ② and ③ (▷ page 191) to separately adjust the air temperature on each side of the passenger compartment. You should raise or lower the temperature setting in small increments, preferably starting at 72°F (22°C). The climate control will adjust to the set temperature as fast as possible.

Increasing

- ▶ Turn temperature control ② and/or ③ (▷ page 191) slightly clockwise.

The climate control system will correspondingly adjust the interior air temperature.

i *If you turn the temperature control fully clockwise for one side of the vehicle, you are increasing the temperature for the other side of the vehicle as well.*

Decreasing





- ▶ Turn temperature control ② and/or ③ (▷ page 191) slightly counterclockwise.

The climate control system will correspondingly adjust the interior air temperature.

i *If you turn the temperature control fully counterclockwise for one side of the vehicle, you are decreasing the temperature for the other side of the vehicle as well.*

Adjusting air distribution

Use air distribution control ④ (▷ page 191) to adjust the air distribution. The following symbols are located on the controls:

Symbol	Function
	Directs air through the center, side and rear passenger compartment air vents
	Directs air to the windshield and the side defroster vents
	Directs air into the entire vehicle interior
	Directs air to the footwells

- ▶ Press button **AUTO** (▷ page 191).

The indicator lamp on the button goes out. The automatic air distribution is switched off. The air distribution is controlled according to the selected control setting.

- ▶ Turn air distribution control ④ (▷ page 191) to the desired symbol.

Opening center and side air vents

- ▶ Turn thumbwheels ②, ⑥ and ⑦ (▷ page 190) upward.

The side air vents ① and ③ and center air vents ⑤ and ⑧ are open.

Closing center and side air vents

- ▶ Turn thumbwheels ②, ⑥ and ⑦ (▷ page 190) downward.

The side air vents ① and ③ and center air vents ⑤ and ⑧ are closed.

Adjusting air volume

Six blower speeds are available.

- ▶ Press button **AUTO** (▷ page 191).

The indicator lamp on the button goes out. The automatic air volume control is switched off. The air volume is controlled according to the currently selected control setting.



- ▶ Use the air volume control ① (▷ page 191) to adjust the air volume.

Front defroster

You can use this setting to defrost the windshield, for example if it is iced up. You can also defog the windshield and the side windows.

 *Keep this setting selected only until the windshield or the side windows are clear again.*

Activating

- ▶ Press button  or  (▷ page 191).

The indicator lamp on the button comes on.



The air conditioning switches automatically to the following functions:

- cooling on to dehumidify
- maximum blowing and heating power
- air flows onto the windshield and the front side windows
- the air recirculation mode is switched off

Climate control

i If you have switched on the defrost function using the  or  button, you cannot make any other settings.

Deactivating

- ▶ Press button  or  (▷ page 191) again.

The indicator lamp on the button goes out. Defrosting is turned off.

The previous settings are once again in effect.

i The cooling remains switched on.

Windshield fogged on the outside

i Keep this setting selected only until the windshield is clear again.

- ▶ Switch the windshield wipers on (▷ page 56).

If the automatic mode of the climate control is switched off:



- ▶ Turn air distribution control  to  or  (▷ page 191).

Air recirculation mode

Switch to air recirculation mode to prevent unpleasant odors from entering the vehicle from the outside (e.g. before driving through a tunnel). This setting cuts off the intake of outside air and recirculates the air in the passenger compartment.

Warning!



Fogged windows impair visibility, endangering you and others. If the windows begin to fog on the inside, switching off the air recirculation mode immediately should clear interior window fogging. If interior window fogging persists, make sure the air conditioning (▷ page 198) is activated, or press button  or .

Activating

- ▶ Press button  (▷ page 191).

The indicator lamp on the button comes on.

i The air recirculation mode is activated automatically at high outside temperatures.

The indicator lamp on button  is not lit when the air recirculation mode is automatically switched on.

A quantity of outside air is added after approximately 30 minutes.

Deactivating

- ▶ Press button  (▷ page 191).

The indicator lamp on the button goes out.

i The air recirculation mode is deactivated automatically:

- after 5 minutes if the outside temperature is below approximately 41 °F (5 °C)
- after 5 minutes if the air conditioning is turned off
- after 30 minutes if the outside temperature is above approximately 41 °F (5 °C)

Air recirculation mode with convenience closing or opening feature

Warning!



Never operate the side windows and the tilt/sliding sunroof* (CLK coupe) if there is the possibility of anyone being harmed by the closing procedure.

When using the air recirculation mode with convenience closing feature, should the upward movement of a window be blocked by some obstructions including but not limited to arms, hands, fingers. etc., the automatic reversal feature will not operate.

In the event that the procedure causes potential danger, the closing of the side windows can be immediately halted by releasing the  button or by pressing or pulling the respective window switch.

CLK coupe:



The closing of the tilt/sliding sunroof* can be immediately halted by releasing the  button or by moving the tilt/sliding sunroof* switch in the overhead control panel in any direction.

Convenience closing

- ▶ Press and hold button  (▷ page 191) until the windows and the tilt/sliding sunroof* (CLK coupe) are closed or have reached the desired position. The indicator lamp on the button comes on. The air recirculation mode is activated.

Convenience opening

- ▶ Press and hold button  (▷ page 191) until the windows and the tilt/sliding sunroof* (CLK coupe) have returned to their previous position or they have reached the desired position. The indicator lamp on the button goes out. The air recirculation mode is deactivated.

i A side window or the tilt/sliding sunroof* (CLK coupe) will only return to its previous position if it has not been moved to another position using the respective side window switch or tilt/sliding sunroof* (CLK coupe) switch after it was closed with button . A side window or tilt/sliding sunroof* (CLK coupe) that was moved will remain in its current position if button  is used to re-open the remaining side windows or tilt/sliding sunroof* (CLK coupe).

Climate control

Air conditioning

The cooling function, is only operational when the engine is running, cools the vehicle interior down to the selected temperature. The cooling function also dehumidifies the air in the vehicle interior, thus preventing the windows from fogging up.

 *Condensation may drip out from underneath the vehicle. This is normal and not an indication of a malfunction.*

Warning!



If you turn off the cooling function, the vehicle will not be cooled when weather conditions are warm. The windows can fog up more quickly. Window fogging may impair visibility and endanger you and others.

Deactivating

It is possible to deactivate the air conditioning (cooling) function of the climate control system. The air in the vehicle will then no longer be cooled or dehumidified.

- ▶ Press button  (▷ page 191).

The indicator lamp on the button goes out.

The cooling function switches off after a short delay.

Activating

Moist air can fog up the windows. You can dehumidify the air with the air conditioning.

- ▶ Press button  (▷ page 191) again.

The indicator lamp on the button comes on.

The air conditioning uses the refrigerant R134a. This refrigerant is free of CFCs which are harmful to the ozone layer.

 *If the air conditioning cannot be turned on again, this indicates that the air conditioning is losing refrigerant. The compressor has turned itself off.*

Have the air conditioning checked at the nearest authorized Mercedes-Benz Center.

Rear passenger compartment adjustable air vents

The air conditioning for the rear passenger compartment is controlled via the climate control panel (> page 191).

i The temperature at the center air vents ② and ③ for the rear passenger compartment (> page 199) is the same as at the dashboard center air vents.

The air vents for the rear passenger compartment are located in the rear center console.

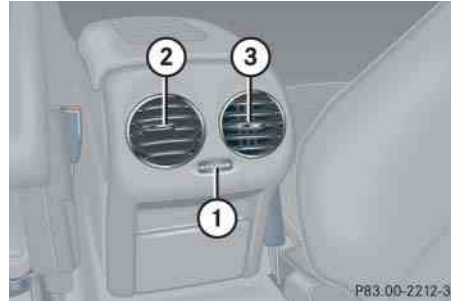

- ① Thumbwheel for air volume control for center air vents
- ② Left center air vent
- ③ Right center air vent

Adjusting air distribution

- ▶ Push the slide for the left center vent ② or right center vent ③ to the left, right, up or down.

The air flow is directed in the corresponding direction.

i For draft-free ventilation, move the slider for the center air vents ② and ③ upward.

Adjusting air volume

- ▶ Turn thumbwheel ① to the left or right.

The air volume is increased or decreased.

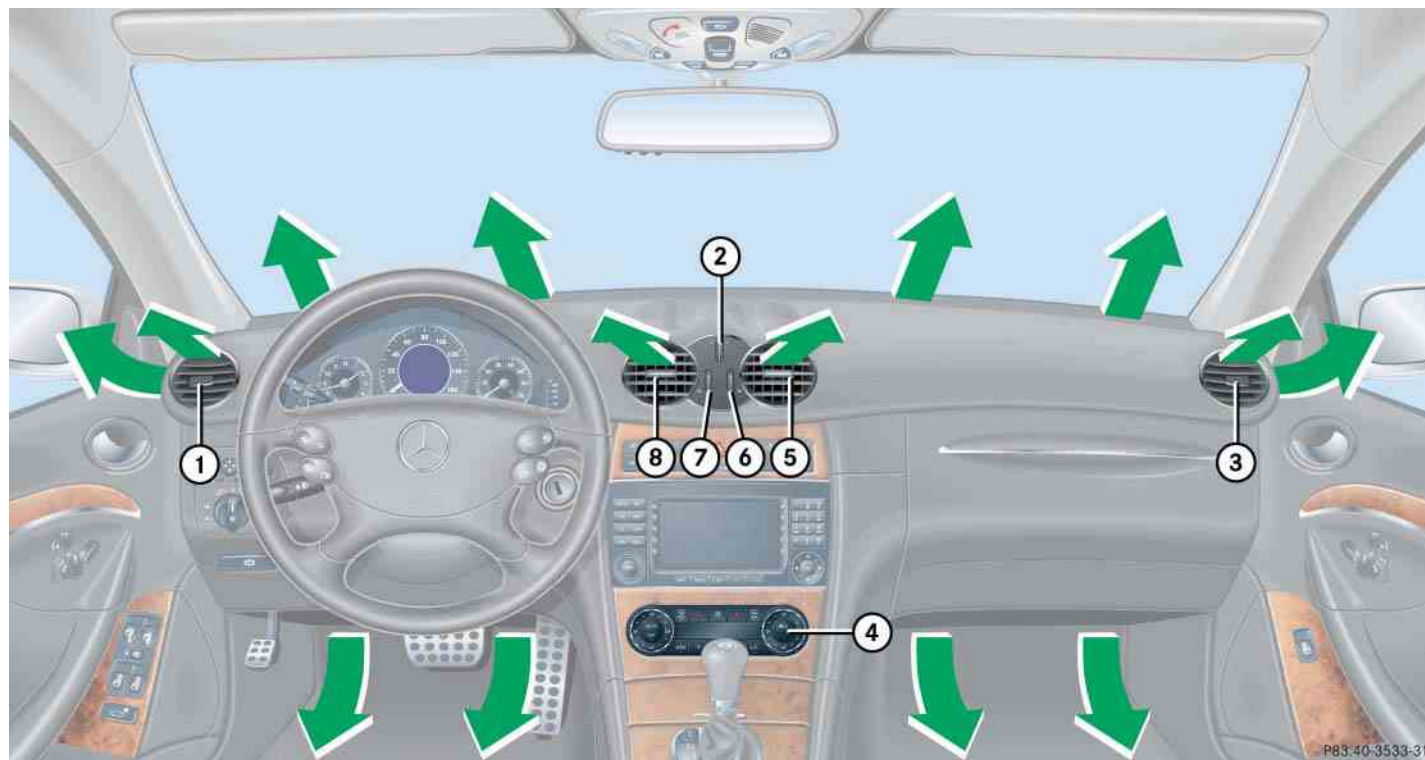

Except CLK 350 Canada

Automatic climate control

Item
① Left side air vent, adjustable
② Thumbwheel for air volume control for center air vents
③ Right side air vent, adjustable
④ Automatic climate control panel
⑤ Right center air vent, adjustable
⑥ Thumbwheel for air volume control for right side center air vent
⑦ Thumbwheel for air volume control for left side center air vent
⑧ Left center air vent, adjustable

i For draft-free ventilation, move the sliders for the center air vents and side air vents to the middle position.



USA only



Canada only

Item
① Left side air distribution control
② Front defroster

Item
③ Temperature control, left, raising
④ Display
⑤ Air volume control, raising
⑥ Temperature control, right, raising
⑦ Rear window defroster
⑧ Right side air distribution control
⑨ Charcoal filter
⑩ AC cooling on/off Residual heat/ventilation (Canada only)
⑪ Temperature control, right, lowering
⑫ Air volume control, lowering
⑬ Temperature control, left, lowering
⑭ Air recirculation
⑮ Automatic climate control on/off (complete system)
⑯ Air distribution and air volume (automatic mode)

Automatic climate control

The automatic climate control is operational whenever the engine is running. You can operate the automatic climate control system in either the automatic or manual mode. The system cools or heats the interior depending on the selected interior temperature and the current outside temperature.

Warning!



When operating the automatic climate control, the air that enters the passenger compartment through the air vents can be very hot or very cold (depending on the set temperature). This may cause burns or frostbite on unprotected skin in the immediate area of the air vents. Always keep sufficient distance between unprotected parts of the body and the air vents. If necessary, use the air distribution controls (▷ page 201) to direct the air to air vents in the vehicle interior that are not in the immediate area of unprotected skin.

Nearly all dust particles, pollutants and odors are filtered out before outside air enters the passenger compartment through the air distribution system.

Warning!



Severe conditions (e.g. strong air pollution) may require replacement of the filter before its scheduled interval. A clogged filter will reduce the air volume to the interior and the windows could fog up, impairing visibility and endangering you and others. Have a clogged filter replaced as soon as possible at an authorized Mercedes-Benz Center.

The air conditioning will not engage (no cooling) if the **A/C** mode is deactivated (▷ page 210).

Warning!



Follow the recommended settings for heating and cooling given on the following pages. Otherwise the windows could fog up, impairing visibility and endangering you and others.

i Keep the air intake grille in front of the windshield free of snow and debris.

Do not obstruct air flow by placing objects on the air flow-through exhaust slots below the rear window.

i If the vehicle interior is hot, ventilate the interior before driving off, see “Summer opening feature” (▷ page 253). The automatic climate control will then adjust the interior temperature to the set value much faster.

Deactivating the automatic climate control system

Warning!



When the automatic climate control is switched off, the outside air supply and circulation are also switched off. Only choose this setting for a short time. Otherwise the windows could fog up, impairing visibility and endangering you and others.

Deactivating

- ▶ Press button **OFF** (▷ page 201).
The indicator lamp on the button comes on.

Reactivating

- ▶ Make sure the ignition is switched on.
- ▶ Press button **OFF** (▷ page 201).
The indicator lamp on the button goes out. The previous settings are once again in effect.

Operating the automatic climate control system in automatic mode

i When operating the climate control system in automatic mode, you will only rarely need to adjust the temperature, air volume and air distribution.

*In automatic mode, the dehumidify function is switched on when the system is cooling. If necessary, this function can be switched off by pushing the button **A/C** or **A/C BEST** (▷ page 201).*

i You can switch the automatic climate control system on and off for each side of the passenger compartment as desired.

Activating

- ▶ Press button **AUTO** (▷ page 201) while the engine is running.
The indicator lamp on the button comes on. The air volume and air distribution are adjusted automatically.

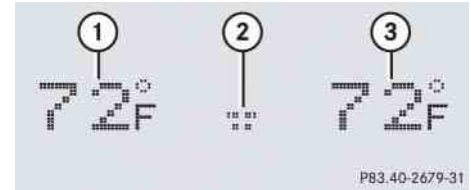

- ① Temperature, left
- ② Blower speed
- ③ Temperature, right

- ▶ Use temperature controls ③ and ⑬ or ⑥ and ⑪ (▷ page 201) to separately adjust the air temperature on each side of the passenger compartment.

The temperature of the vehicle interior is adjusted automatically.

Deactivating

- ▶ Press button **AUTO** (▷ page 201) again.
The indicator lamp on the button goes out. The automatic operation of air volume and air distribution switches off.

Automatic climate control

Setting the temperature

Use temperature controls ③ and ⑬ for the left side or ⑥ and ⑪ for the right side (▷ page 201) to separately adjust the air temperature on each side of the passenger compartment. You should raise or lower the temperature setting in small increments, preferably starting at 72°F (22°C). The automatic climate control will adjust to the set temperature as fast as possible.

Increasing

- ▶ Press and hold temperature button ③ and/or ⑥ (▷ page 201) until the desired temperature appears in the display ④ (▷ page 201).

The automatic climate control system will correspondingly adjust the interior air temperature.

i *If you increase the temperature for one side of the vehicle to the highest adjustable value then you will see the message HI in the display. This also increases the temperature for the other side of the vehicle.*

Decreasing





- ▶ Press and hold temperature button ⑪ and/or ⑬ (▷ page 201) until the desired temperature appears in the display ④ (▷ page 201).

The automatic climate control system will correspondingly adjust the interior air temperature.

i *If you decrease the temperature for one side of the vehicle to the lowest adjustable value then you will see the message LO in the display. This also decreases the temperature for the other side of the vehicle.*

Adjusting air distribution

Use the air distribution controls ① and ⑧ (▷ page 201) to separately adjust the air distribution on each side of the passenger compartment. The following symbols are located on the controls:

Symbol	Function
	Directs air to the windshield and the side defroster vents
	Directs air into the entire vehicle interior
	Directs air to the footwells
	Directs air through the center, side and rear passenger compartment air vents

- ▶ Turn air distribution control ① or ⑧ (▷ page 201) to the desired symbol.

The indicator lamp on the button **AUTO** goes out.

The automatic air distribution is switched off. The air distribution is controlled according to the selected control setting.

- i** You can also turn the air distribution control to a position between two symbols.

Opening center and side air vents

- ▶ Turn thumbwheels ②, ⑥ and ⑦ (▷ page 200) upward.

The center air vents ⑤ and ⑧ and side air vents ① and ③ (▷ page 200) are open.



Closing center and side air vents

- ▶ Turn thumbwheels ②, ⑥ and ⑦ (▷ page 200) downward.



The center air vents ⑤ and ⑧ and side air vents ① and ③ (▷ page 200) are closed.

Automatic climate control

Adjusting air volume

Use button **AUTO** (▷ page 201) for automatic mode or air volume controls  or  (▷ page 201) to adjust air volume manually.

Seven blower speeds are available.

- ▶ Press button  to decrease or  (▷ page 201) to increase air volume to the desired level.

The indicator lamp on the button **AUTO** goes out.



The automatic air distribution remains switched on.

Front defroster

You can use this setting to defrost the windshield, for example if it is iced up. You can also defog the windshield and the side windows.

i *Keep this setting selected only until the windshield or the side windows are clear again.*

Activating

- ▶ Press button  or  (▷ page 201).

The indicator lamp on the button comes on.

The air conditioning switches automatically to the following functions:

- cooling on to dehumidify
- maximum blowing and heating power
- air flows onto the windshield and the front side windows
- the air recirculation mode is switched off

i *If you have switched on the defrost function using the  or  button, you cannot make any other settings.*

Deactivating

- ▶ Press button  or  (▷ page 201) again.

The indicator lamp on the button goes out.

The previous settings are once again in effect.



i *The cooling remains switched on.*

Windshield fogged on the outside

i *Keep this setting selected only until the windshield is clear again.*

- ▶ Switch the windshield wipers on (▷ page 56).

If the automatic mode of the automatic climate control is switched off:

- ▶ Turn air distribution control ① or ⑧ to  or  (▷ page 201).

Maximum cooling MAXCOOL

If the left and right air distribution controls as well as the airflow volume control are set to **AUTO** (▷ page 201) and there is a high need for cooling, the display “MAXCOOL” appears.



This provides the fastest possible cooling of the vehicle interior (when side windows and tilt/sliding sunroof* or soft top are closed).

Air recirculation mode

Switch to air recirculation mode to prevent unpleasant odors from entering the vehicle from the outside (e.g. before driving through a tunnel). This setting cuts off the intake of outside air and recirculates the air in the passenger compartment.

Warning!



Fogged windows impair visibility, endangering you and others. If the windows begin to fog on the inside, switching off the air recirculation mode immediately should clear interior window fogging. If interior window fogging persists, make sure the air conditioning (▷ page 210) is activated, or press button  or .

Activating

- ▶ Press button  (▷ page 201).
The indicator lamp on the button comes on.

 The air recirculation mode is activated automatically at high outside temperatures.

The indicator lamp on button  is not lit when the air recirculation mode is automatically switched on.

A quantity of outside air is added after approximately 30 minutes.

Deactivating

- ▶ Press button  (▷ page 201).

The indicator lamp on the button goes out.

 The air recirculation mode is deactivated automatically:

- after 5 minutes if the outside temperature is below approximately 41 °F (5 °C)
- after 5 minutes if the air conditioning is turned off
- after 30 minutes if the outside temperature is above approximately 41 °F (5 °C)

Automatic climate control

Air recirculation mode with convenience closing or opening feature

Warning!



Never operate the side windows and the tilt/sliding sunroof* (CLK coupe) if there is the possibility of anyone being harmed by the closing procedure.

When using the air recirculation mode with convenience closing feature, should the upward movement of a window be blocked by some obstructions including but not limited to arms, hands, fingers. etc., the automatic reversal feature will not operate.

In the event that the procedure causes potential danger, the closing of the side windows can be immediately halted by releasing the  button or by pressing or pulling the respective window switch.

CLK coupe:



The closing of the tilt/sliding sunroof* can be immediately halted by releasing the  button or by moving the tilt/sliding sunroof* switch in the overhead control panel in any direction.

Convenience closing

- ▶ Press and hold button  (▷ page 201) until the windows and the tilt/sliding sunroof* (CLK coupe) are closed or have reached the desired position. The indicator lamp on the button comes on. The air recirculation mode is activated.

Convenience opening

- ▶ Press and hold button  (▷ page 201) until the windows and the tilt/sliding sunroof* (CLK coupe) have return to their previous position or they have reached the desired position. The indicator lamp on the button goes out. The air recirculation mode is deactivated.



i A side window or the tilt/sliding sunroof* (CLK coupe) will only return to its previous position if it has not been moved to another position using the respective side window switch or tilt/sliding sunroof* (CLK coupe) switch after it was closed with button . A side window or tilt/sliding sunroof* (CLK coupe) that was moved will remain in its current position if button  is used to re-open the remaining side windows or tilt/sliding sunroof* (CLK coupe).

Charcoal filter

An activated charcoal filter markedly reduces bad odors and removes pollutants from air entering the passenger compartment. The charcoal filter can be activated or deactivated.

The system switches automatically to the air recirculation mode, if the

- charcoal filter is switched on
- carbon monoxide (CO) or nitrogen oxide (NO_x) concentration of the outside air increases beyond a predetermined level

i *The automatic air recirculation mode does not function if the A/C (indicator lamp on button  or  not lit) mode is deactivated, or if the outside temperature has fallen below 41 °F (5 °C).*

Activating

- ▶ Press button  (▷ page 201).
The indicator lamp on the button comes on.

i *If you press and hold button , the side windows and tilt/sliding sunroof* will close.*

i *The activated charcoal filter should be switched off when windows fog up on the inside, or if the passenger compartment needs to be quickly heated or cooled down.*

Warning!



Never operate the side windows and the tilt/sliding sunroof* (CLK coupe) if there is the possibility of anyone being harmed by the closing procedure.

When using the air recirculation mode with convenience closing feature, should the upward movement of a window be blocked by some obstructions including but not limited to arms, hands, fingers. etc., the automatic reversal feature will not operate.

In the event that the procedure causes potential danger, the closing of the side windows can be immediately halted by releasing the  button or by pressing or pulling the respective window switch.

CLK coupe:



The closing of the tilt/sliding sunroof* can be immediately halted by releasing the  button or by moving the tilt/sliding sunroof* switch in the overhead control panel in any direction.

Deactivating

- ▶ Press button  (▷ page 201).

The indicator lamp on the button goes out.

i *If you press and hold button , the side windows and the tilt/sliding sunroof* (CLK coupe) will return to their previous position.*

A side window or tilt/sliding sunroof (CLK coupe) will only return to its previous position if it has not been moved to another position using the respective side window switch or tilt/sliding sunroof* (CLK coupe) switch after it was closed with button . A side window or tilt/sliding sunroof* (CLK coupe) that was moved will remain in its current position if button  is used to re-open the remaining side windows or tilt/sliding sunroof* (CLK coupe).*

Automatic climate control

Air conditioning

The cooling function, only operational when the engine is running, cools the vehicle interior down to the selected temperature. The cooling function also dehumidifies the air in the vehicle interior, thus preventing the windows from fogging up.

 *Condensation may drip out from underneath the vehicle. This is normal and not an indication of a malfunction.*



Warning!



If you turn off the cooling function, the vehicle will not be cooled when weather conditions are warm. The windows can fog up more quickly. Window fogging may impair visibility and endanger you and others.

Deactivating

It is possible to deactivate the air conditioning (cooling) function of the automatic climate control system. The air in the vehicle will then no longer be cooled or dehumidified.



- ▶ Press button  or  (▷ page 201).

The indicator lamp on the button goes out.

The cooling function switches off after a short delay.

Activating

Moist air can fog up the windows. You can dehumidify the air with the air conditioning.

- ▶ Press button  or  (▷ page 201) again.

The indicator lamp on the button comes on.

The air conditioning uses the refrigerant R134a. This refrigerant is free of CFCs which are harmful to the ozone layer.

 *If the air conditioning cannot be turned on again, this indicates that the air conditioning is losing refrigerant. The compressor has turned itself off.*

Have the air conditioning checked at the nearest authorized Mercedes-Benz Center.

Residual heat and ventilation* (Canada only)

With the engine switched off, it is possible to continue to heat or ventilate the interior for up to 30 minutes. This feature makes use of the residual heat produced by the engine.

 *How long the system will provide heating depends on*

- *the coolant temperature*
- *the temperature set by the operator*

The blower will run at speed setting 1 regardless of the air distribution control setting.

Activating

- ▶ Switch off the ignition (▷ page 40).
- ▶ Press button  (▷ page 201).

The indicator lamp on the button comes on.

Deactivating

- ▶ Press button  (▷ page 201).

The indicator lamp on the button goes out.

The residual heat is automatically turned off:

- when the ignition is switched on
- after about 30 minutes
- if the battery voltage drops

Automatic climate control

Rear passenger compartment adjustable air vents

The air conditioning for the rear passenger compartment is controlled via the automatic climate control panel (▷ page 201).

i The temperature at the center air vents ② and ③ for the rear passenger compartment (▷ page 212) is the same as at the dashboard center air vents.

The air vents for the rear passenger compartment are located in the rear center console.

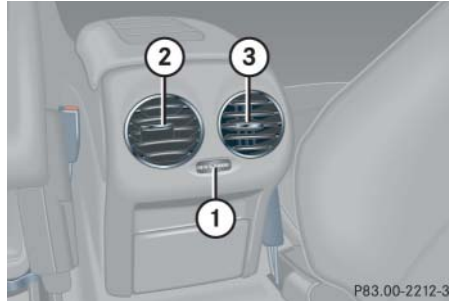

- ① Thumbwheel for air volume control for center air vents
- ② Left center air vent
- ③ Right center air vent

Adjusting air distribution

- ▶ Push the slide for the left center vent ② or right center vent ③ to the left, right, up or down.

The air flow is directed in the corresponding direction.

i For draft-free ventilation, move the slider for the center air vents ② and ③ upward.

Adjusting air volume

- ▶ Turn thumbwheel ① to the left or right.

The air volume is increased or decreased.

▼ Audio system

Audio and telephone*, operation

These instructions are intended to help you become familiar with your Mercedes-Benz audio system. They contain useful tips and a detailed description of the user functions.

Warning!



In order to avoid distraction which could lead to an accident, the driver should enter system settings with the vehicle at a standstill and operate the system only when road and traffic conditions permit. Always pay full attention to traffic conditions first before operating system controls while driving.

Bear in mind that at a speed of just 30 mph (approximately 50 km/h), your car is covering a distance of 44 feet (approximately 14 m) every second.

Operating safety

Warning!



Any alterations made to electronic components can cause malfunctions.

The radio, amplifier, CD changer*, satellite radio*, and telephone* are interconnected. When one of the components is not operational or has not been removed/replaced properly, the function of other components may be impaired.

This condition might seriously impair the operating safety of your vehicle.

We recommend that you have any service work on electronic components carried out at an authorized Mercedes-Benz Center.

Sound system*

Your vehicle is equipped with a sound system. The subwoofer in the CLK cabriolet is located between the rear seats.

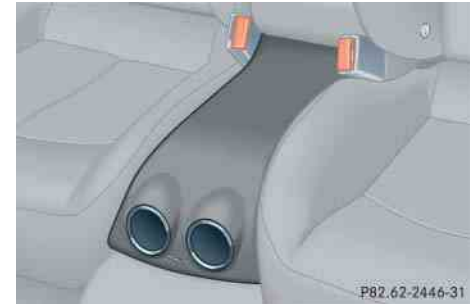

! Make sure no objects fall into the openings of the subwoofer between the rear seats.

If necessary, contact an authorized Mercedes-Benz Center to remove any objects which may have fallen into the openings.

Audio system

Operating and display elements

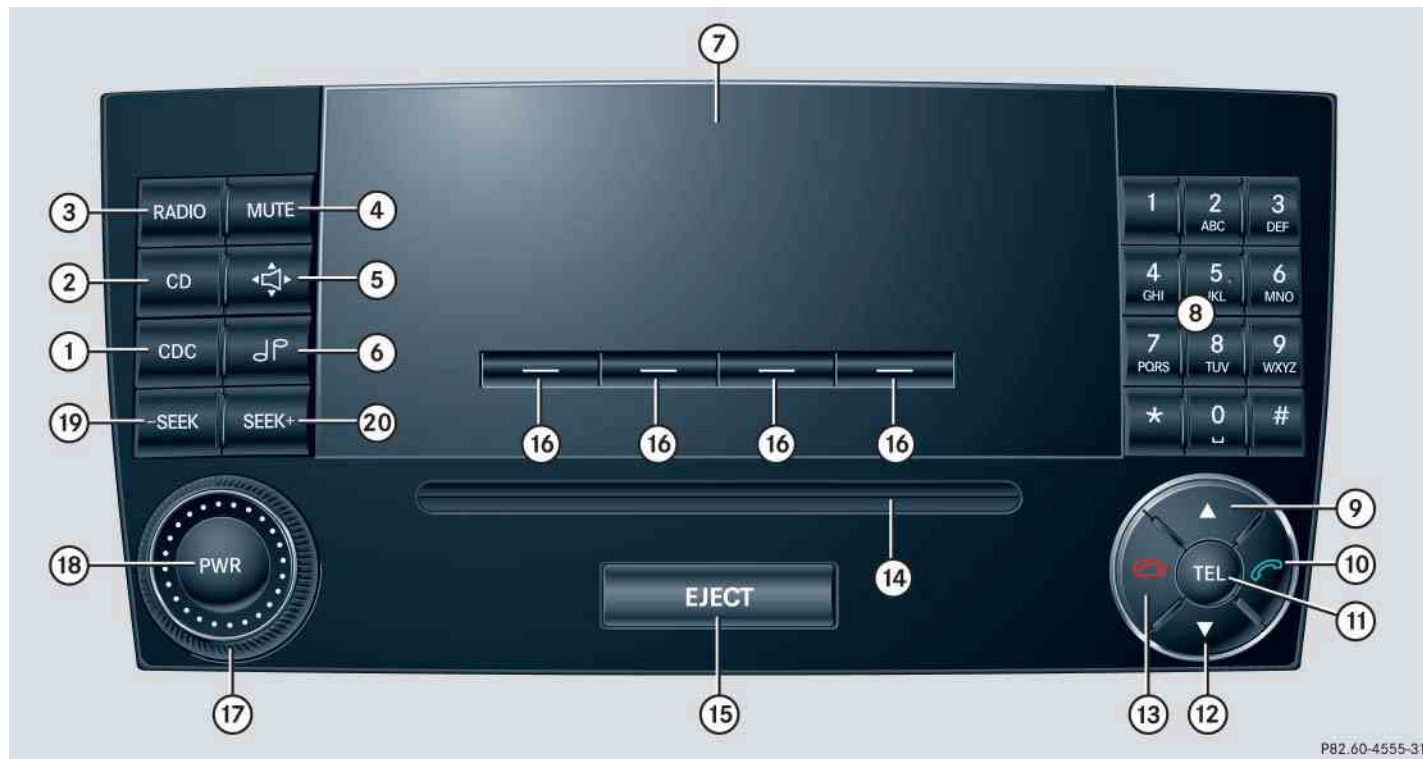

P82.60-4555-31

Item	Page
① CD changer mode selector	229
AUX mode selector	219
② Single CD mode selector	231
③ Radio mode selector	
④ Mute function (radio)	224
Pause (CD)	235
⑤ Volume distribution	218
⑥ Sound settings	216
⑦ Display	
⑧ Alphanumeric keypad	

Item	Page
⑨ Speed dialing memory (telephone) in descending order	
⑩ Accepting a call (telephone)	240
⑪ Telephone mode selector	236
⑫ Speed dialing memory (telephone) in ascending order	237
⑬ Terminating a call (telephone)	241
⑭ CD slot	
⑮ CD ejection	232

Item	Page
⑯ Soft keys	216
⑰ Volume	216
⑱ Switching on/off	216
⑲ Manual tuning / seek tuning (radio)	222
Track search, reverse (CD)	234
⑳ Manual tuning / seek tuning (radio)	222
Track search, fast forward (CD)	234

Audio system

Button and soft key operation

In these instructions, the alphanumeric keypad (right side of radio panel) and the function buttons (left side of radio panel) are referred to as “buttons”. The four keys below the display panel are referred to as “soft keys”.

! Do not press directly in the display face. Otherwise, the display will be damaged.

Operation

Switching the unit on/off

Switching on

- ▶ Turn the SmartKey in the starter switch to position **1** or **2**.
- ▶ If the audio system was on as you removed the SmartKey from the starter switch, the audio system will automatically come back on as you turn the SmartKey to position **1** or **2**.

or

- ▶ Press **POWER** button.

i If the radio is switched on without the key in the starter switch, it will automatically switch off again after approximately 30 minutes.

If your vehicle is equipped with a telephone, the display may prompt you to enter your PIN (GSM network) or code (TDMA or CDMA network).

Switching off

- ▶ Remove SmartKey from starter switch.
- or
- ▶ Press **POWER** button.

i Should excessively high temperatures occur while the audio system is being operated, the display will dim. If temperatures continue to rise, HIGH TEMP will appear in the display, after which the audio system will be switched off for a cooling-down period.

Adjusting the volume

- ▶ Turn rotary control of **POWER** button.

The volume will increase or decrease depending on the direction turned.

i If your vehicle equipment includes a Mercedes-Benz specified mobile phone*, you can adjust its volume separately from the volume of the audio system while the telephone is being used.

Adjusting sound functions

The bass and treble functions are called up by pressing the **BASS** button.

Settings for bass and treble are stored separately for the AM and FM wavebands, weather band, CD mode and telephone mode.

Bass

- ▶ Press **BASS** button repeatedly until BASS appears in the display.



PB2.60-4450-31

- ▶ Press + or - soft key to increase or decrease tone level accordingly.

or

- ▶ Press RES soft key briefly to reset bass tones to their center level.

The radio switches back to the standard radio menu eight seconds after the last soft key is pressed.

Adjusting treble

- ▶ Press **JP** button repeatedly until TREBLE appears in the display.



- ▶ Press + or - soft key to increase or decrease tone level accordingly.

or

- ▶ Press RES soft key briefly to reset treble tones to their center level.

The radio switches back to the standard radio menu eight seconds after the last soft key is pressed.

Sound system*

You can either program the sound settings manually (▷ page 216) or choose settings via preset sound characteristics.

You can select from among the following settings:

- STANDARD: conventional stereo sound.
 - SURROUND: the sound is set for better three-dimensional acoustic characteristics.
 - SPEECH: the sound is optimized for the spoken word.
- ▶ Press **JP** button repeatedly until STANDARD, SURROUND or SPEECH appears in the display.

- ▶ Press <<< or >>> soft key repeatedly until the desired sound setting has been reached.

The sound is set accordingly.

or

- ▶ Press RES soft key briefly.

The sound setting is reset depending on the sound source activated.

- Radio mode: STANDARD
- CD/AUX mode: SURROUND
- Telephone: SPEECH

The radio switches back to the standard radio menu eight seconds after the last soft key is pressed.

Audio system

Returning sound functions to factory settings

- ▶ Press  button to call up settings menu in the display.



- ▶ Press RES soft key briefly; the respective sound function is reset to its center level.

or

- ▶ Press and hold RES soft key until RESET appears in the display.

The sound settings for bass and treble are returned to their center level and the volume is set to a predefined level.

Vehicles with sound system*:

The sound setting is reset depending on the sound source activated.

- Radio mode: STANDARD
- CD/AUX mode: SURROUND
- Telephone: SPEECH

The radio switches back to the standard radio menu four seconds after the last soft key is pressed.



Adjusting volume distribution

Call up fader and balance functions by pressing the  button.

Fader

- ▶ Press  button repeatedly until FADER appears in the display.



- ▶ Press  or  soft key.

The volume is distributed accordingly between the front and rear of the vehicle.

or

- ▶ Press RES soft key briefly.

The fader is reset to its center level.

The radio switches back to the standard radio menu eight seconds after the last soft key is pressed.

Adjusting balance

- ▶ Press  button repeatedly until BALANCE appears in the display.



- ▶ Press <<< or >>> soft key.

The volume is distributed between the left and right sides of the vehicle.

or

- ▶ Press RES soft key briefly.

The balance is reset to its center level.

The radio switches back to the standard radio menu eight seconds after the last button is pressed.

Returning volume distribution to factory settings

- ▶ Press  button to call up settings menu in the display.



- ▶ Press RES soft key briefly; the respective volume distribution is reset to its center (flat) level.

or

- ▶ Press and hold RES soft key until RESET appears in the display.

The volume distribution settings for fader and balance are set to their center level.

The radio switches back to the standard radio menu four seconds after the last soft key is pressed.

Telephone* muting

If your vehicle equipment includes a Mercedes-Benz specified mobile phone*, you can adjust its volume separately from the volume of the audio system while the telephone is being used.

Connecting an external audio source (AUX) to the radio

An external audio source (AUX) can be connected to the audio system. The cinch-connector for connecting the external audio source (AUX) is located in the glove box. Please contact an authorized Mercedes-Benz Center for more information.



- ① External audio source (AUX) cinch-connector

Audio system

Warning!



Only operate an external audio source (AUX) when the vehicle is stationary. There is a risk of accident by being distracted from road and traffic conditions if you operate an external audio source (AUX) while the vehicle is in motion.

Bear in mind that at a speed of just 30 mph (approximately 50 km/h), your car is covering a distance of 44 feet (approximately 14 m) every second.

Calling up AUX mode

Warning!



Due to the different volumes of the external audio sources, system messages (e.g. traffic and navigation announcements) may be much louder. You may need to disable these system messages or adjust the volume of these messages manually.

- ▶ Press and hold **cdc** button until AUX appears in the display.

The device connected with the external audio source cinch-connector is heard, provided it is switched to playback.

- i** Please refer to the relevant manufacturers operating instruction for the external audio source device.

You can adjust the volume (▷ page 216), the sound settings (▷ page 216) and the volume distribution (▷ page 218) for the AUX input.

The following settings can be made in the audio AUX mode:

- Volume (▷ page 216)
- Sound settings (▷ page 216)
- Volume distribution (▷ page 218)

i The volume of external audio sources is extremely variable. It is possible that a device connected as an external audio source will sound quieter or louder in the vehicle or that the usual maximum volume cannot be achieved. On certain devices the volume can be set separately. In this case, start at a moderate volume and increase it slowly. In this way, you can determine whether the system is capable of playback without distortion, even at high volume.

Canceling AUX mode

- ▶ Press any audio source button.

The AUX mode is canceled.

Radio operation

Selecting radio mode

- ▶ Press **RADIO** button.

Calling up wavebands

You can choose from among the FM, AM and WB wavebands.

Weather band (▷ page 224).

i *FM waveband: 87.7.....107.9 MHz*

AM waveband: 530.....1710 KHz

Calling up wavebands for radios without SAT*

- ▶ Press FM or AM soft key to switch between FM and AM.

The FM and AM wavebands are called up one after another.

or

- ▶ Press WB soft key.

The weather band menu is called up.

The waveband currently selected appears in the upper left-hand corner of the display.

Calling up wavebands for radios with SAT*

- ▶ Press FM, AM or WB soft key repeatedly until desired waveband has been selected.

The FM, AM and WB wavebands are called up one after another.

The waveband currently selected appears in the upper left-hand corner of the display.

Selecting a station

The following options are available for selecting a station:

- Direct frequency input (▷ page 222)
- Manual tuning (▷ page 222)
- Automatic seek tuning (▷ page 222)
- Scan search (▷ page 222)
- Station memory (▷ page 223)
- Automatic station memory (Autostore) (▷ page 223)

The station search proceeds in the following frequency increments:

- 200 kHz in FM range
- 10 kHz in AM range

Audio system

Direct frequency input

- ▶ Select desired waveband.



PB2.60-4454-31

- ▶ Press ***** button.
- ▶ Enter desired frequency with buttons **1** to **0**.

i You can only enter frequencies within the respective waveband.

If a button is not pressed within four seconds, the radio will return to the last station tuned.

Manual tuning

- ▶ Select desired waveband.
- ▶ Press **SEEK+** or **-SEEK** button for approximately three seconds.
- ▶ Press button repeatedly until desired frequency has been reached.

Step-by-step station tuning takes place in ascending or descending order. Each time the button is pressed, the radio tunes further by 0.2 MHz. During manual tuning, the radio is muted.

Automatic seek tuning

- ▶ Select desired waveband.
- ▶ Press **SEEK+** or **-SEEK** button briefly.

The radio will tune to the next highest or next lowest receivable frequency.

i If no station is received after two consecutive scans of the complete frequency range, then the scan stops at the frequency from which it began.

Scan search

- Starting scan search
 - ▶ Select desired waveband.



PB2.60-4459-31

- ▶ Press **SC** soft key.
 - SC will appear in the display. The radio briefly tunes in all receivable stations on the waveband selected.
- Ending scan search
 - ▶ Press **SC** soft key or **SEEK+** or **-SEEK**.
 - The station last played will be selected and SC disappears from the display.

Station memory

You can store ten AM and ten FM stations in the memory.

- Storing stations
 - ▶ Tune in desired station.
 - ▶ Press and hold desired station button **1** to **0** until a brief signal tone is heard.
The frequency is stored on the selected station button.
- Calling up stations
 - ▶ Press desired station button **1** to **0** briefly.

Autostore – automatic station memory

The Autostore memory function provides an additional memory level. The station memory for manually stored stations is not overwritten.

- Calling up Autostore memory level and storing stations



- ▶ Press AS soft key briefly.
The radio switches to the Autostore memory level. AS and SEARCH appear in the display and the radio finds the ten stations with the strongest signals. These stations are stored on the station buttons **1** to **0** in order of signal strength.
- Calling up stations
 - ▶ Press desired station button **1** to **0**.
- Leaving the Autostore memory level
 - ▶ Press FM or AM soft key briefly.

Audio system

Interrupting radio mode

The radio mode is interrupted by an incoming call on the telephone* (▷ page 240)

- Mute on
 - ▶ Press **MUTE** button.
The radio mode is interrupted and MUTED appears in the display.
- Mute off
 - ▶ Press **MUTE** button.
The radio mode is again active.

Weather band



- ▶ Press WB soft key.

The weather band station last received is tuned in.

Selecting a weather band station directly

- ▶ Select desired weather band station with buttons **1** to **7** PRESET.

If a station cannot be tuned in, a search is automatically started.

Search

- ▶ Press **SEEK+** or **-SEEK** button to tune in the next receivable weather band station.

i *If no weather band station is received after three consecutive scans of the complete frequency range, then the scan stops at the channel with which it began and NO WB FOUND appears in the display.*

If this happens, switch back to standard radio mode.

Scan search

- Starting scan search
 - ▶ Press **SC** soft key.
SC will appear in the display. The radio briefly tunes in all receivable weather band stations.
- Ending scan search
 - ▶ Press **SC** soft key or **SEEK+** or **-SEEK**.
The weather band station last played will be selected and SC disappears from the display.

Satellite radio*

SIRIUS satellite radio provides over 100 channels of digital-quality radio. That includes music, sports, news, and entertainment, free of commercials. SIRIUS satellite radio uses three high-orbit satellites to broadcast 24 hours per day, coast to coast.

This diverse, satellite-delivered programming is available for a monthly subscription fee.

For more information and service availability, call the SIRIUS Service Center (1-888-539-7474), or contact www.siriusradio.com for USA or www.siriuscanada.ca for Canada.

i *Additional satellite radio equipment and a subscription to a satellite radio service provider are required for the satellite radio operation described here.*

Contact an authorized Mercedes-Benz Center for details and availability for your vehicle.

Note that categories and channels shown in illustrations are dependent on programming content delivered by the service provider. Programming content is subject to change. Therefore, channels and categories shown in illustrations and descriptions contained in this manual may differ from the channels and categories delivered by the service provider.

i *Satellite radio service may be unavailable or interrupted from time to time for a variety of reasons, such as environmental or topographic conditions and other things beyond the service provider's or our control. Service might also not be available in certain places (e.g., in tunnels, parking garages, or within or next to buildings) or near other technologies.*

Program categories

The channels are categorized. Categories allow you to tune to stations broadcasting a certain type of program (category mode) (▷ page 227).

Calling up the SAT main menu

▶ Press SAT soft key.

SAT is displayed in the upper left-hand corner of the display.

Prior to activation of the satellite radio service (▷ page 226).

After activation of satellite radio service (▷ page 226).

Audio system

Prior to activation of the satellite radio service



The telephone number of the SIRIUS Service Center (888-539-7474) is displayed.

- ▶ Press ESN soft key.

The twelve-digit electronic serial number (ESN) of the SAT tuner* installed in your vehicle is displayed.

This information is required to call the SIRIUS Service Center for an activation request.

i Credit card information may also be required for your application.

The activation process takes approximately five to ten minutes after calling the SIRIUS Service Center.

After activation of the satellite radio service

The satellite radio main menu appears. The radio station selected last is audible, provided it can be received.

i The system will tune to a default station if no station had been selected previously.



The first channel 001 is called up and the PTY system changes to All categories.

If no station can be received, ACQUIRING appears in the display.

If the Satellite radio service is not activated, ACQUIRING will also appear in the radio display and NO SAT will appear in the multifunction display.

Selecting a station

The following options are available:

- Selecting a station using the selected category (▷ page 227),
- Tuning via station presets (▷ page 226),
- Tuning via scan search (▷ page 228),
- Tuning via manual channel input (▷ page 227),
- Tuning via the program category list (▷ page 227).

Tuning via station presets

Ten satellite radio station presets are available.

You can access the presets via number keys.

Accessing via number keys

- ▶ Enter number of preset you wish to select, e.g. **1**.

The radio plays the station stored under this number and the PTY function changes to the category corresponding to the station.

Tuning via manual channel input



Example: tuning in channel 16

- ▶ Press *****.

Input line appears in the main radio menu.

- ▶ Use number keys to enter desired channel within eight seconds, e.g. **1** **6**.

The system tunes to channel 16.

The station you have selected begins to play.

i You can only enter available channel numbers.

Tuning via the program category list

The category list contains all currently receivable categories of programs. It is arranged alphabetically.

- Selecting a category
 - ▶ Press PTY soft key.



The current PTY category of the station is displayed.

- ▶ Press <<< or >>> soft key.

This switches between the individual categories.

When changing the category, the channel selected last in the new category becomes audible.

The system will automatically switch to a station of the selected category if the currently selected station is not of the selected category. Otherwise, the currently selected station remains tuned.

- Tuning a station within the selected category

The channels identified for the currently selected category are arranged numerically. Only one entry is visible at a time.

- ▶ Press **SEEK+** or **-SEEK** button briefly.

The next station within the category is started.

or



Audio system

- ▷▷ ▶ Press and hold **SEEK+** or **SEEK-** button for approximately three seconds until desired station has been reached.

Tuning via scan search

Scan search is characterized as follows:

- Scan search plays a channel for approximately eight seconds and then skips to the next channel within the current category.
- Scan search can be terminated manually.
- ▶ Press **SC** soft key.
The search starts. **SC** appears in the display.
- ▶ Press **SC** soft key again.
The search stops.

Obtaining additional text information

Additional text information (artist, title) related to the current channel can be displayed.

- ▶ Press **INF** soft key.
The title being played is displayed.
- ▶ Press **INF** soft key again.
The name of the artist performing the title being played is displayed.

i *If a button is not pressed within four seconds, the radio will return to the standard display.*

Storing stations

- ▶ Tune in desired station.
- ▶ Press and hold desired station button **1** to **0** until a brief signal tone is heard.
The frequency is stored on the selected station button.

The radio saves the current station at the memory preset selected. The memory preset selected appears in the status line, e.g. S3.

i *There are ten presets available.*

An existing entry is overwritten in the memory list when a new entry is given.

Calling up the ESN information menu

- ▶ Press **INF** soft key.
- ▶ Press **ESN** soft key.
The twelve-digit electronic serial number (ESN) of the SAT tuner* installed in your vehicle is displayed.
- ▶ Press **RET** soft key to exit the menu.

CD mode

Safety precautions

Warning!



The single CD player and the CD changer* are Class 1 laser products. There is a danger of invisible laser radiation if the housing is opened or damaged.

Do not open the housing. The single CD player and the CD changer* do not contain any parts that can be serviced by the user. For safety reasons, have any necessary service work performed only by qualified personnel.

Warning!



In order to avoid distraction which could lead to an accident, the driver should insert CDs with the vehicle at a standstill and operate the audio system only if permitted by road, weather and traffic conditions.

Bear in mind that at a speed of just 30 mph (approximately 50 km/h), your car covers a distance of 44 feet (approximately 14 m) every second.

General notes

The system may not be able to play audio CDs with copy protection.

Playing copied CDs may cause malfunctions during playback.

! *If you affix stickers to the CDs, they can become warped due to the heat that develops in the CD drive or CD changer.*

In certain situations, the CDs can then no longer be ejected and cause damage to the drive. Such damage is not covered by the Mercedes-Benz Limited Warranty.

! *Your CD drive or CD changer* has been designed to play CDs which correspond to the EN 60908 standard. You can therefore only use CDs with a maximum thickness of 1.3 mm.*

If you insert thicker data carriers, e.g. ones that have data on both sides (one side with DVD data, the other side with audio data), they cannot be ejected and will damage the drive.

Do not use CDs with an eight cm diameter, not even with a CD adapter. Attempting to play CDs with an eight cm diameter or playing such CDs with an adapter may cause damage to the CD drive. Such damage is not covered by the Mercedes-Benz Limited Warranty.

Should excessively high or low temperatures occur while in CD changer mode*, CD ERROR will appear in the display, and the CD will be muted until the temperature has reached an acceptable level for the system to continue operation.

The single CD player play audio CDs, the CD changer* can play audio CDs as well as CDs with MP3 files.

Audio system

Tips on handling CDs

- Handle CDs carefully to prevent interference during playback.
- Avoid scratches, fingerprints and dust on the CDs.
- Do not write on CDs or apply any labels or other material to them.
- Clean CDs from time to time with a commercially available cleaning cloth. Never wipe the CD in a circular motion; instead, wipe it in a straight line starting in the center and moving outward. Do not use solvents, anti-static sprays, etc. for cleaning.
- Replace the CD in its case after use.
- Protect CDs from heat and direct sunlight.

MP3 notes

The CD changer* can play audio CDs as well as CDs with MP3 files.

Information on MP3 data carriers

i CD media, CD burning software and CD writers are available in great variety. Due to this variety, it cannot be guaranteed that the CD changer will be able to play every user-written CD.

The burning process can lead to data errors and aging of the medium may result in data loss. Therefore, the CD changer may be restricted in its ability to play MP3 data carriers; it may play them with reduced sound quality, or it may not be able to play them at all.

Problems may be encountered during playback of user-written CDs with a storage capacity of more than 700 MB. These CDs do not meet valid standards as of this printing.

Compatible MP3 data carriers

The CD changer can read the following data carriers in MP3 mode:

- CD-DA
- CD-R
- CD-RW

Compatible file systems and compression methods

Use Romeo or Joliet. Depending on file format used, up to 128 characters are possible

The following compression methods are compatible:

- MP3
- WMA
- WAV

Compatible bit and sampling rates

Fixed and variable bit rates of up to 320 kBit/s are possible.

The following table lists possible sampling rates:

MPEG1 Audio Layer 3	44.1 kHz, 48 kHz, 32 kHz
MPEG2 Audio Layer 3	22.5 kHz, 24 kHz, 16 kHz
MPEG 2.5 Audio Layer 3	11.025 kHz, 12 kHz, 8 kHz
WMA	32 kHz, 44.1 kHz, 48 kHz

i Only use MP3 tracks with a bite rate of 128 kBit/s or higher and with the specified sampling rates.

The use of rates other than those specified may lead to noticeably inferior sound quality.

Information on copyright

The music tracks that you create for use in MP3 mode or that you play in MP3 mode are subject to copyright laws under applicable international and national regulations.

In many countries, the reproduction of copyrighted materials is not permitted, even if only for personal use, without the express prior consent of the copyright holder.

Please check the current copyright laws for your country and comply with them.

These restrictions do not apply, for example, to your own compositions and recordings, or for recordings for which authorization has been obtained from the copyright holder.

MP3 playback

You can play an CD with MP3 files on the CD changer* as you would play any standard audio CD. All of the functions described for the CD changer also apply for the playback of CDs with MP3 files. Keep in mind that the single CD player in the audio system unit is not able to read CDs with MP3 files.

The first 99 tracks on the CD, including tracks in subdirectories, are recognized and played. Any additional tracks will not be played.

i Due to the branched data structure, playback of the first track may be delayed slightly.

Operating the single CD player in the audio system unit

Loading a CD

The single CD player in the audio system unit has capacity for one CD. The CD slot for loading the drive is located underneath the soft keys.

i Keep in mind that the single CD player in the audio system unit is not able to play CDs with MP3 files.

- ▶ Make sure the system is switched on.
- ▶ Insert CD into CD slot. The label side of the CD must face upwards.

The system automatically pulls the CD into the CD slot. The audio CD begins to play.



Audio system

▷▷ **i** If a CD is already loaded, it must be ejected before inserting a new CD. Inserting a second CD in the slot with another CD still loaded will cause damage to the CD drive not covered by the Mercedes-Benz Limited Warranty.

i If a CD has been inserted incorrectly or cannot be read, **WRONG CD ERROR** will appear in the display.

Ejecting a CD

- ▶ Make sure the system is switched on.
- ▶ Press **EJECT** button.

The system ejects the CD. **NO CD** will appear in the display.

- ▶ Remove CD from slot.

i If you do not take the CD out of the CD slot within approximately 15 seconds, the system automatically pulls the CD back in and plays it.

If a CD is pulled back in, press the **EJECT** button for five seconds; the CD will then be ejected.

Operational readiness of CD changer*

If a CD changer has been installed in the vehicle, it can be operated from the front control panel of the audio system. A loaded magazine must be installed to play CDs.

The CD changer is located in the glove box.

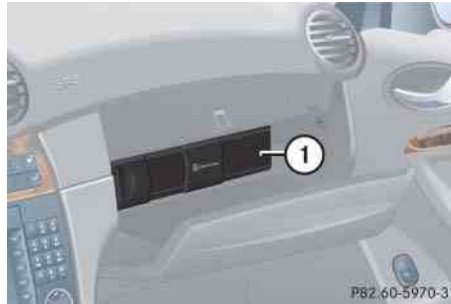

① CD changer

Loading/unloading the CD magazine

i The CD changer* may not be able to play audio CDs with copy protection.

- ▶ Slide changer door to the right and press  button.
- ▶ Magazine will be ejected.

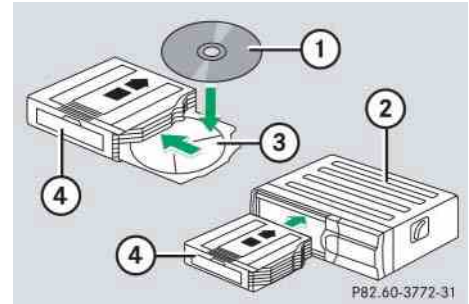

- ① CD
- ② CD changer
- ③ CD tray
- ④ CD magazine

- ▶ Remove magazine ④ and pull CD tray ③ fully out.
- ▶ Place CD ① in recess of tray, label side up.
- ▶ Push tray into magazine in the direction of arrow.

i Improperly inserted or unreadable CDs will not be played.

- ▶ Push magazine into CD changer* ② in the direction of arrow and close sliding door.

Playing CDs

Single CD player in the audio unit

- ▶ Press **CD** button.

CD 0 will appear in the upper left-hand corner of the display.

The CD will resume playback at the point where it was switched off.

CD changer*

- ▶ Press **cdc** button.

CD and the selected magazine slot number appear in the upper left-hand corner of the display.

If you have not removed a CD since the last time the CD audio source was activated, the last CD listened to will begin to play at the point where it was switched off.

After the last track on a CD has finished, the next CD is automatically played.

Playing tracks

You have the following options:

- Audio system with CD changer*: selecting CDs
- Direct track entry
- Track skip forward/reverse
- Fast forward/reverse
- Scan
- Random tracks
- Repeat track

Selecting CDs in the audio unit with CD changer*



- ▶ You can select from among the inserted CDs with buttons

0 to **6**.

0 = CD player in the audio unit

1 to **6** = CDs in the CD changer*

The magazine slot number of the selected CD appears next to CD in the display, and the number of the currently played track appears next to TRACK.

i If there is no CD in the selected magazine slot, NO CD appears in the display with the corresponding slot number.

Audio system

Direct track entry



You can make a direct selection from among the tracks on a CD.

- ▶ Press ***** button.
- ▶ Enter track number using buttons **1** to **0**.

The number of the track being played appears next to **TRACK** in the display.

You can only enter available track numbers.

Skipping tracks forward/backward

- Skipping tracks forward
 - ▶ Press **SEEK+** button briefly.
The next track will be played.
- Skipping tracks backward
 - ▶ Press **-SEEK** button briefly.

If the track has been playing for more than ten seconds, the unit skips back to the beginning of the track currently playing. If less than ten seconds have been played, the unit skips back to the beginning of the previous track.

Pressing the **-SEEK** or **SEEK+** button repeatedly will result in multiple tracks being skipped.

Fast forward/reverse

- Fast forward
 - ▶ Press and hold **SEEK+** button until desired point has been reached.
- Reverse
 - ▶ Press and hold **-SEEK** button until desired point has been reached.

i *The track number and the relative time of the track is shown in the display during the search.*

Scan

- Starting scan
 - ▶ Press **SC** soft key.
SC will appear in the display.
Each track on the current CD will be played for approximately eight seconds in ascending order.
- Ending scan
 - ▶ Press **SC** soft key or **-SEEK** or **SEEK+**.

Random play

The random function (RDM) plays the tracks of the current CD in random order.

i When you start the RDM function, the RPT function is automatically switched off.

- Switching on random
 - ▶ Press RDM soft key.

RDM appears in the display. A randomly selected track is played.
- Switching off random
 - ▶ Press RDM soft key again.

Repeat

The track being played is repeated until the repeat function is switched off.

i When you start the RPT function, the RDM function is automatically switched off.

- Switching on repeat
 - ▶ Press RPT soft key.

RPT appears in the display.

- Switching off repeat
 - ▶ Press RPT soft key again.

Pause function

The CD changer mode is interrupted by an incoming call on the telephone* (▷ page 240).

- Switching on pause function



- ▶ Press **MUTE** button.

The CD changer mode is interrupted and PAUSE appears in the display.
- Switching off pause function
 - ▶ Press **MUTE** button.

The CD changer mode is active again.

Track and time display



- ▶ Press T soft key.

The number of the track being played and the elapsed playing time appear in the display.
- ▶ Press T soft key again.

The total number of tracks and the total playing time of the CD appear in the display.
- ▶ Press T soft key.

The standard CD playback menu appears in the display.

Audio system

GSM network phones

Warning!



Please do not forget that your primary responsibility is to drive the vehicle. A driver's attention to the road must always be his/her primary focus when driving. For your safety and the safety of others, we recommend that you pull over to a safe location and stop before placing or taking a telephone call.

If you choose to use the telephone¹ while driving, please use the hands-free device and only use the telephone when road, weather and traffic conditions permit. Some jurisdictions prohibit the driver from using a cellular telephone while driving a vehicle.

Bear in mind that at a speed of just 30 mph (approximately 50 km/h), your vehicle is covering a distance of 44 feet (approximately 13.5 m) every second.

¹ Observe all legal requirements.

Using your Mercedes-Benz specified mobile phone*, a number of functions and operating steps can be performed and displayed in the audio system display.

Further operating instructions not covered here can be found in the operating instructions for the multifunction steering wheel and the cellular telephone*.

If your audio system is set up for telephone operation, the  symbol will appear in the display.

When you insert your Mercedes-Benz specified mobile phone* into the telephone cradle, you will be prompted to enter your PIN for 30 seconds (▷ page 237). This display disappears when you press any button.

When your mobile phone is inserted into the telephone cradle, you will see the reception strength in the upper right-hand corner of the display.

Switching on the telephone

Switching on the telephone

- ▶ Press **TEL** button.

If the telephone was previously switched off, **PROCESSING** appears in the display and you will then be prompted to enter your PIN.

Switching off the telephone

- ▶ Press **TEL** button for approximately three seconds.

PROCESSING appears in the display until the telephone is off. Afterward, **PHONE OFF** appears in the display.

PIN entry



- ▶ Enter PIN number using buttons **1** to **0**.
- ▶ If necessary, correct number entered with the CLR soft key. Press soft key briefly to delete the last digit entered; press soft key and hold to delete the complete number.
- ▶ Press OK soft key after entering correct PIN.
- ▶ READY or ROAMING will appear in the display.

i If the PIN is entered incorrectly three times, NEED PUK will appear in the display. Enter PUK via your telephone. Please refer to the separate telephone operating instructions for more information.

Adjusting the volume

- ▶ Turn rotary control of  button during a telephone call.

The volume will increase or decrease depending on the direction turned.

i The volume can be adjusted separately for telephone mode and audio mode.

Adjusting sound

- ▶ Adjust sound during a telephone call. Sound adjustment (▷ page 216).

Placing a call

Entering a telephone number and starting the dialing process



- ▶ Enter desired telephone number using buttons **1** to **0**.

The number can have up to 32 digits, but only twelve of these are visible in the display.

- ▶ If necessary, correct number entered with the CLR soft key. Press soft key briefly to delete the last digit entered; press soft key and hold to delete the complete number.
- ▶ After correct telephone number has been entered, press  button.

Audio system

i If the telephone number has been saved together with a name in the telephone book, the name will appear in the display.

Phone book

The numbers stored in the phone book of the telephone can be called up either by name or number.

In addition, incoming calls are stored in the phone book.

i This is only possible, however, when the call information transmitted includes the number of the person calling. If the telephone number is not transmitted, NO NUMBER will be stored in the phone book.

- Searching and calling up telephone book entries by name

You can access your mobile phone's phone book using the audio system. You can access both the main entries and the sub-entries of your phone book.



- ▶ Press MEM soft key or press **▲** or **▼**.

- ▶ Press desired numerical key **2 ABC** to **9 WXYZ**.

The stored entries are selected according to the alphabetical order of the initial letters (e.g. for S -Schneider, press button **7 PQRS** four times).

or

- ▶ Press and hold button **▲** or **▼**.

The system jumps from one initial letter to the next in ascending or descending order.

- ▶ Press and hold button **▲** or **▼** until desired initial letter has been reached.

or

- ▶ Press button **▲** or **▼** repeatedly until desired entry has been reached.

The stored entries are selected in alphabetical order with the sub-entries.



i Several sub-entries can be stored for each main entry (name). These entries are marked by a corresponding abbreviation that appears in the upper left-hand corner of the display. The following abbreviations for sub-entries are possible:



CEL = Mobile phone
HOM = Home
WOR = Work
FAX = Fax
PAG = Pager
TEL = Main

- ▶ When you have selected a number, press  button.
The call will be made.
- Viewing the telephone number of a telephone book entry
 - ▶ Search for desired entry.
 - ▶ Press NUM soft key.



The telephone number of the phone book entry appears in the display.
- Returning calls received







- ▶ Press MEM soft key or press  or .



- ▶ Press RCV soft key (received calls).
The number of received calls and then the call last received appear briefly in the display.
 - ▶ Select desired telephone number with button  or .
- The letter R and the number of the memory position appear in the upper left-hand corner of the display. The numbers are stored in the order of the calls received.
- ▶ When you have selected a number, press  button.
The call will be made.

- Speed dial

If you have stored telephone numbers as speed dial numbers in your telephone, you can also enter these with buttons  to  on the radio head unit.

 - ▶ Press desired button  to  briefly.
 - ▶ Press  button.
The call will be made.
- Turbo dial

If you have stored telephone numbers as turbo dial numbers in your telephone, you can also enter these with buttons  to  on the radio head unit.

 - ▶ Press desired button  to  until the call is made.

Audio system

Redial

If the number you have dialed is busy, you can again place calls to the last ten telephone numbers dialed using the redial function.

i If you have activated the automatic redial function on your telephone, the number of the person being called is automatically redialed after a short waiting period if there is a busy signal. Refer to the separate operating instructions for the mobile phone.

- Manual redial



- ▶ Press  button.

The telephone number last dialed will appear in the display.

- ▶ Select desired telephone number with button  or .

The letter L and the number of the memory position appears in the left-hand corner of the display. The numbers are stored in the order of the calls made.

- ▶ When you have selected a number, press  button.

The call will be made.

Accepting an incoming call

If the telephone is active in the background (reception symbol is visible in the display), the audio source is muted when an incoming call is received. A ringing tone can be heard and the caller's telephone number, or the name under which the telephone number has been saved in the phone book, appears in the display. If the caller's number is not transmitted with the call, CALL will appear in the display.

- ▶ Press  button.

The call is accepted.

Muting a call

It is possible to mute a call; the caller is then no longer able to hear you.

- Mute on
 - ▶ Press MUT soft key.
 - ▶ MIC MUTE will appear in the display.
- Mute off
 - ▶ Press MUT soft key again.

Terminating a call

- ▶ Press  button.

The current call is terminated and the muted audio source becomes active again.

Talking with two callers at the same time

If you wish to receive or place another call during an already active call, you can accept or place the second call and switch between the callers or combine them into one call. Note that the features described here are depending on availability from your mobile phone service provider.







- Placing/accepting a second call
 - ▶ Place new call by entering telephone number manually.
 - ▶ Press  button.
You are connected to the second caller; the first caller is kept on hold.

or

- ▶ Press  button to accept a second call.

 You will be notified of the second call acoustically, but you will not see this in the display.

You are connected with the second caller; the first caller is kept on hold.

- Switching between calls
 - ▶ Press  and  buttons.
This switches between the calls. The non-active call is kept on hold.
- Terminating a call
 - ▶ Press  button.
The current call is terminated. You are again connected with the caller previously placed on hold.
- Combining two calls
 - ▶ Press  and  buttons.
The calls are combined into one call.
- Terminating a combined call
 - ▶ Press  button.
The connection to both callers is terminated.

Audio system

TDMA or CDMA network phones

Warning!



Please do not forget that your primary responsibility is to drive the vehicle. A driver's attention to the road must always be his/her primary focus when driving. For your safety and the safety of others, we recommend that you pull over to a safe location and stop before placing or taking a telephone call.

If you choose to use the telephone¹ while driving, please use the hands-free device and only use the telephone when road, weather and traffic conditions permit. Some jurisdictions prohibit the driver from using a cellular telephone while driving a vehicle.

Bear in mind that at a speed of just 30 mph (approximately 50 km/h), your vehicle is covering a distance of 44 feet (approximately 13.5 m) every second.

¹ Observe all legal requirements.

Using your Mercedes-Benz specified mobile phone*, a number of functions and operating steps can be performed and displayed in the audio system display.

Further operating instructions not covered here can be found in the operating instructions for the multifunction steering wheel and the mobile phone*.

If your audio system is set up for telephone operation, the  symbol will appear in the display.

When you insert your Mercedes-Benz specified mobile phone* into the telephone cradle, you will be prompted to enter your PIN for 30 seconds (▷ page 237). This display disappears when you press any button.

When your mobile phone is inserted into the telephone cradle, you will see the reception strength in the upper right-hand corner of the display.

Switching on the telephone

Switching on the telephone

- ▶ Press **TEL** button.

If you have programmed an unlock code for the telephone, you must now enter the code.



- ▶ Enter code using buttons **1** to **0**.
- ▶ If necessary, correct number entered with the CLR soft key. Press soft key briefly to delete the last digit entered; press soft key and hold to delete the complete number.

- ▶ Press OK soft key after entering correct code.

The telephone is unlocked. If you have entered an incorrect code, you must enter the correct code.

Switching off the telephone

- ▶ Press **TEL** button for approximately three seconds.

PROCESSING appears in the display until the telephone is off. Afterward, PHONE OFF appears in the display.

Adjusting the volume

- ▶ Turn rotary control of  button during a telephone call.

The volume will increase or decrease depending on the direction turned.

 The volume can be adjusted separately for telephone mode and audio mode.

Adjusting sound

- ▶ Adjust sound during a telephone call. Sound adjustment (▷ page 216).

Placing a call

Entering a telephone number and starting the dialing process



- ▶ Enter desired telephone number using buttons **1** to **0**.

The number can have up to 32 digits, but only twelve of these are visible in the display.

- ▶ If necessary, correct number entered with the CLR soft key. Press soft key briefly to delete the last digit entered; press soft key and hold to delete the complete number.
- ▶ After correct telephone number has been entered, press  button. ▷▷

Audio system

- ▷▷ **i** *If the telephone number has been saved together with a name in the phone book, the name will appear in the display.*

Phone book

The numbers stored in the phone book of the mobile phone can be called up either by name or number.

In addition, incoming calls are stored in the phone book.

i *This is only possible, however, when the call information transmitted includes the number of the person calling. If the telephone number is not transmitted, NO NUMBER will be stored in the phone book.*

- Searching and calling up phone book entries by name

You can access your mobile phone's phone book with the audio system. You can access both the main entries and the sub-entries of your phone book.



- ▶ Press MEM soft key or press **▲** or **▼**.

- ▶ Press desired numerical key **2 ABC** to **9 WXYZ**.

The stored entries are selected according to the alphabetical order of the initial letters (e.g. for S-Schneider, press button **7 PQRS** four times).

or

- ▶ Press and hold button **▲** or **▼**.

The system jumps from one initial letter to the next in ascending or descending order.

- ▶ Press and hold button **▲** or **▼** until desired initial letter has been reached.

or

- ▶ Press button **▲** or **▼** repeatedly until desired entry has been reached.

The stored entries are selected in alphabetical order with the sub-entries.

i Several sub-entries can be stored for each main entry (name). These entries are marked by a corresponding abbreviation that appears in the upper left-hand corner of the display. The following abbreviations for sub-entries are possible:

CEL = Mobile phone

HOM = Home

WOR = Work

FAX = Fax

PAG = Pager

TEL = Main



- ▶ When you have selected a number, press  button.



The call will be made.

- Viewing the telephone number of a phone book entry
 - ▶ Search for desired entry.
 - ▶ Press NUM soft key.

The telephone number of the phone book entry appears in the display.
- Returning calls received





- ▶ Press MEM soft key or press  or .
- ▶ Press RCV soft key (received calls).



The number of received calls and then the call last received appear briefly in the display.
- ▶ Select desired telephone number with button  or .

The letter R and the number of the memory position appear in the upper left-hand corner of the display. The numbers are stored in the order of the calls received.
- ▶ When you have selected a number, press  button.

The call will be made.



- Speed dial



If you have stored telephone numbers as speed dial numbers in your telephone, you can also enter these with buttons  to  on the radio unit.

- ▶ Press desired button  to  briefly.
- ▶ Press  button.

The call will be made.

- Turbo dial

If you have stored telephone numbers as turbo dial numbers in your telephone, you can also enter these with buttons  to  on the radio unit.

- ▶ Press desired button  to  until the call is made.

Audio system

Redial

If the number you have dialed is busy, you can again place calls to the last ten telephone numbers dialed using the redial function.

i If you have activated the automatic redial function on your mobile phone, the number of the person being called is automatically redialed after a short waiting period if there is a busy signal.

Refer to the separate operating instructions for the mobile phone.

- Manual redial



- ▶ Press  button.

The telephone number last dialed will appear in the display.

- ▶ Select desired telephone number with button  or .

The letter L and the number of the memory position appears in the left-hand corner of the display. The numbers are stored in the order of the calls made.

- ▶ When you have selected a number, press  button.

The call will be made.

Accepting an incoming call

If the telephone is active in the background (reception symbol is visible in the display), the audio source is muted when an incoming call is received. A ringing tone can be heard and the caller's telephone number, or the name under which the telephone number has been saved in the telephone book, appears in the display. If the caller's number is not relayed, CALL will appear in the display.

- ▶ Press  button.

The call is accepted.

Muting a call

It is possible to mute a call; the caller is then no longer able to hear you.

- Mute on
 - ▶ Press MUT soft key.
 - ▶ MIC MUTE will appear in the display.
- Mute off
 - ▶ Press MUT soft key again.

Terminating a call

- ▶ Press  button.

The current call is terminated and the muted audio source becomes active again.



Accepting a second incoming call

If you receive another call during an already active call, you can accept the second call and switch between the two.

- Accepting a second call
 - ▶ Place new call by entering telephone number manually.

 *You will be notified of the second call acoustically, but you will not see this in the display.*

You are connected to the second caller; the first caller is kept on hold.

- Switching between calls
 - ▶ Press  button.
This switches between the calls. The non-active call is kept on hold.
- Terminating a call
 - ▶ Press  button.
The current call is terminated. The connection to the caller previously kept on hold is also interrupted; however, reconnection is indicated by an acoustic signal.



Placing a second call

If you wish to place another call during an already active call, you can place the second call and switch between the callers or combine them into one call. Note that this feature is dependent on availability from your mobile phone service provider.

- Placing a second call
 - ▶ Place a new call by entering telephone number manually.

- ▶ Press  button.

You are connected to the second caller; the first caller is kept on hold.

- Terminating a call
 - ▶ Press  button.
The current call is terminated. The connection to the caller previously kept on hold is also interrupted; however, reconnection is indicated by an acoustic signal.
- Combining two calls
 - ▶ Press  button.
The calls are combined into one call.
- Terminating a combined call
 - ▶ Press  button.
The connection to both callers is terminated.

Audio system

Emergency calls “911”

The following describes how to dial a “911” emergency call using the audio system head unit when a Mercedes-Benz specified mobile phone* is inserted in the phone cradle*. Unless otherwise specified, the descriptions refer to the audio system head unit.

Consult the separate telephone operating instructions that came with your mobile phone* for information on how to place a “911” emergency call on the mobile phone*.

Warning!



The “911” emergency call system is a public service. Using it without due cause is a criminal offense.

The following conditions must be met for a “911” emergency call:

- Telephone must be switched on.
- The corresponding mobile communications network must be available.

 *Emergency calls may not be possible with all telephone networks or if certain network services and/or telephone functions are active. Check with your local service providers.*

If you cannot make an emergency call, you will have to initiate rescue measures yourself.

GSM network phones

Placing a “911” emergency call using audio head unit with the phone locked

- ▶ Press **TEL** button to switch to telephone operation.
PIN? appears in the audio display.
- ▶ Enter 911 using the number keypad on the audio head unit.
- ▶ Press OK soft key or  button for dialing to begin.
DIALING appears in the audio display while the telephone establishes the connection.
- ▶ Wait until the emergency call center answers, then describe the emergency.

Placing a “911” emergency call using audio head unit with the phone unlocked

- ▶ Press **TEL** button to switch to telephone operation.
- ▶ Enter 911 using the number keypad on the audio head unit.
- ▶ Press  button for dialing to begin.
DIALING appears in the audio display while the telephone establishes the connection.
- ▶ Wait until the emergency call center answers, then describe the emergency.

i *If no SIM card is in the mobile phone, NO SERVICE appears in the audio display. In that case, you only can make an emergency call on the mobile phone itself, without the use of the head unit.*

TDMA/CDMA network phones

Placing a “911” emergency call using audio head unit with the phone locked

- ▶ Press **TEL** button to switch to telephone operation.
CODE? appears in the audio display.
- ▶ Enter 911 using the number keypad on the audio head unit.
- ▶ Press OK soft key or  button for dialing to begin.
DIALING appears in the audio display while the telephone establishes the connection.
- ▶ Wait until the emergency call center answers, then describe the emergency.

Placing a “911” emergency call using audio head unit with the phone unlocked

- ▶ Press **TEL** button to switch to telephone operation.
- ▶ Enter 911 using the number keypad on the audio head unit.
- ▶ Press  button for dialing to begin.
DIALING appears in the audio display while the telephone establishes the connection.
- ▶ Wait until the emergency call center answers, then describe the emergency.

Power windows

Opening and closing the windows

The side windows are opened and closed electrically. The switches for all the side windows are on the driver's door. The switches for the respective windows are on the front passenger door and the rear side trim panels.



- ① Left front window
 - ② Right front window
 - ③ Right rear window
 - ④ Left rear window
 - ⑤ Rear window override switch
- (▷ page 88)

Warning!





When closing the windows, make sure there is no danger of anyone being harmed by the closing procedure.

The closing of the door windows can be immediately halted by releasing the switch or, if switch was pulled past the resistance point and released, by either pressing or pulling the respective switch.

The closing of the rear side windows can be immediately halted by releasing the switch.

The door windows are equipped with the express-close and automatic reversal function. If a door window encounters an obstruction that blocks its path in a circumstance where you pulled the switch past the resistance point and released it to close the window, the automatic reversal function will stop the window and open it slightly.



If a door window encounters an obstruction that blocks its path in a circumstance where you are closing the window by pulling and holding the switch, by pressing and holding button  on the SmartKey, by pressing and holding the lock button (vehicles with KEYLESS-GO*) on an outside door handle, CLK cabriolet: by operating the soft top switch, or by pressing and holding button  or  on the climate control panel, the automatic reversal function will not operate.

When leaving the vehicle, always remove the SmartKey or SmartKey with KEYLESS-GO* from the starter switch, take it with you, and lock the vehicle. Do not leave children unattended in the vehicle, or with access to an unlocked vehicle. A child's unsupervised access to a vehicle could result in an accident and/or serious personal injury.

i You can also open or close the windows using the:

- SmartKey (summer opening/convenience feature) (▷ page 253)
- CLK cabriolet: Soft top switch (▷ page 255).

Depending on current position, the windows may also open or close when:

- the air recirculation button  in the control panel of the climate control (▷ page 191) or automatic climate control (▷ page 201) is pressed and held
or
- the charcoal filter button  in the control panel of the automatic climate control (▷ page 201) is pressed and held

i Operating the rear side windows from the rear is not possible if you activate the override switch (▷ page 88).

i After switching off the ignition (▷ page 38) or removing the SmartKey from the starter switch, the power windows can be operated:

- until you open a door
- for at least 5 minutes if no door was opened

- ▶ Switch on the ignition (▷ page 40).

Opening the windows

- ▶ Press switch ① to ④ to the resistance point.

The corresponding window will move downwards until you release the switch.

Closing the windows

- ▶ Pull switch ① to ④ to the resistance point.

The corresponding window will move upwards until you release the switch.

Warning!



If you pull and hold the switch up when closing the window, and upward movement of the window is blocked by some obstruction including but not limited to arms, hands, fingers, etc., the automatic reversal will not operate.

Fully opening the door windows (Express-open)

- ▶ Press switch ① or ② past the resistance point and release.

The corresponding window opens completely.

Power windows

Fully closing the door windows (Express-close)

- ▶ Pull switch ① or ② past the resistance point and release.

The corresponding window closes completely.

! *If the upward movement of a door window is blocked during the closing procedure, the door window will stop and open slightly.*

Remove the obstruction, pull the switch again past the resistance point and release.

If the door window still does not close when there is no obstruction, then pull the switch and hold it. The door window will then close without the obstruction sensor function.

Warning!



Driver's door only:

If within five seconds you again pull the switch past the resistance point and release, the automatic reversal will not function.

Stopping windows during Express-operation

- ▶ Press or pull the respective power window switch again.

Synchronizing power windows

The power windows must be resynchronized each time

- after the battery has been disconnected.
 - if the power windows cannot be fully opened (Express-open) or closed (Express-close).
- ▶ Switch on the ignition (▷ page 40).
 - ▶ Pull the power window switches until the side windows are closed.
 - ▶ Hold the switches for approximately one second.



The power windows are synchronized.

Summer opening feature

Warning!



Never operate the windows and/or the tilt/sliding sunroof* (CLK coupe), or soft top (CLK cabriolet), if there is the possibility of anyone being harmed by the opening or closing procedure.

In the event that the procedure causes potential danger, the procedure can be immediately halted by releasing the button on the SmartKey. To reverse direction of movement, press  for opening or  for closing.

If the weather is warm, you can ventilate the vehicle before driving off by simultaneously:

- opening the side windows
- opening the tilt/sliding sunroof* (CLK coupe)
- opening the soft top (CLK cabriolet)

- turning on the seat ventilation* for the driver's seat

 *The seat ventilation* for the driver's seat is automatically set to the highest level if activated via summer opening feature.*



- ▶ Aim transmitter eye of the SmartKey or SmartKey with KEYLESS-GO* at the driver's outside door handle. The SmartKey or SmartKey with KEYLESS-GO* must be in close proximity to the driver's door handle.

- ▶ Press and hold button  after unlocking the vehicle until the windows and the tilt/sliding sunroof* (CLK coupe) have reached the desired position or the soft top (CLK cabriolet) is fully open.

The windows and tilt/sliding sunroof* (CLK coupe) or soft top (CLK cabriolet) begin to open after approximately one second.

CLK cabriolet: The message *Top In Operation* appears in the multifunction display.

- ▶ Release button  to interrupt procedure.

CLK cabriolet: Make sure the soft top is fully opened.

Power windows

Convenience closing feature



Warning!



When closing the side windows and/or the tilt/sliding sunroof* (CLK coupe), or soft top (CLK cabriolet), make sure there is no danger of anyone being harmed by the closing procedure.

The windows will not automatically re-open if blocked during convenience closing.

If potential danger exists, proceed as follows:

- Release button  to stop the closing procedure. To open, press and hold button . To continue the closing procedure after making sure that there is no danger of anyone being harmed by the closing procedure, press and hold button .

Vehicles with KEYLESS-GO*:

- Release the lock button (▷ page 62) on exterior door handle to stop the closing procedure.

- Immediately pull on the same outside door handle and hold firmly. The side windows and the tilt/sliding sunroof* (CLK coupe), or soft top (CLK cabriolet) will open for as long as the door handle is held but the door is not opened.

When you lock the vehicle, you can close the windows and the tilt/sliding sunroof* (CLK coupe), or soft top (CLK cabriolet) simultaneously.

- ▶ Aim transmitter eye of the SmartKey or SmartKey with KEYLESS-GO* at the driver's outside door handle (▷ page 253). The SmartKey or SmartKey with KEYLESS-GO* must be in close proximity to the driver's door handle.
- ▶ Press and hold button  until the windows and the tilt/sliding sunroof* (CLK coupe), or soft top (CLK cabriolet) are completely closed.

The windows and the tilt/sliding sunroof* (CLK coupe), or soft top (CLK cabriolet) begin to close after approximately one second.

The message **Top In Operation** appears in the multifunction display.

- ▶ Release button  to interrupt procedure.

Vehicles with KEYLESS-GO*:

- ▶ Press and hold the lock button on an outside door handle (▷ page 62) until the side windows and the tilt/sliding sunroof* (CLK coupe) are completely closed.
- ▶ Release the lock button on the outside door handle to interrupt procedure.

Make sure all side windows and the tilt/sliding sunroof* (CLK coupe), or soft top (CLK cabriolet) are properly closed before leaving the vehicle.

Opening and closing all side windows with the soft top switch (CLK cabriolet)

The soft top switch is located in the center console.

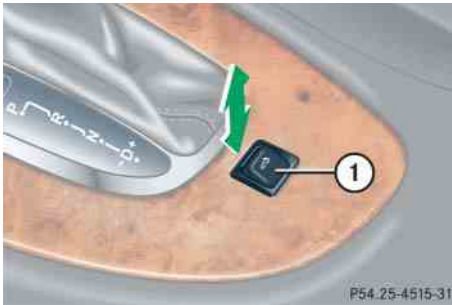

① Soft top switch

As an alternate method to using the power window switches, all side windows can be opened or closed using the soft top switch ①.

Warning!



Never operate the windows if there is the possibility of anyone being harmed by the opening or closing procedure.

In case the procedure causes potential danger, the procedure can be immediately halted by releasing the soft top switch. To open the windows again, press the soft top switch twice. Press the switch briefly the first time. Then press the switch a second time and hold it until the side windows have reached the desired position.

- ▶ Switch on the ignition.

Opening

- ▶ Press soft top switch ① twice. Press the switch briefly the first time. Then press the switch a second time and hold it until the side windows have reached the desired position.

Closing

- ▶ Pull soft top switch ① twice. Pull the switch briefly the first time. Then pull the switch a second time and hold it until the side windows have reached the desired position.

Power tilt/sliding sunroof* (Coupe)

Opening and closing the power tilt/sliding sunroof

The tilt/sliding sunroof can be opened and closed electrically. The switch for the tilt/sliding sunroof is on the overhead control panel.

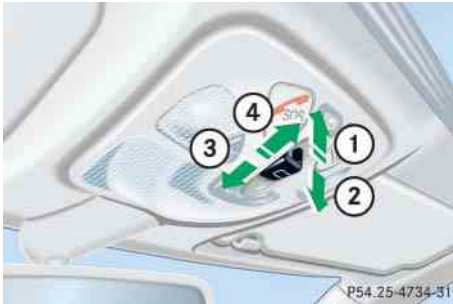

Sunroof switch

- ① Push up to raise sunroof at rear
- ② Pull down to lower sunroof at rear
- ③ Push forward to slide sunroof closed
- ④ Push back to slide sunroof open

With the sunroof closed or tilted open, a screen can be slid into the roof opening to guard against sun rays. When sliding the sunroof open, the screen will also retract.



Screen

Warning!



When closing the tilt/sliding sunroof, make sure there is no danger of anyone being harmed by the closing procedure.

The opening/closing procedure of the tilt/sliding sunroof can be immediately halted by releasing the switch or, if the

switch was moved past the resistance point and released, by moving the switch in any direction.

The tilt/sliding sunroof is made out of glass. In the event of an accident, the glass may shatter. This may result in an opening in the roof.

In a vehicle rollover, occupants not wearing their seat belts or not wearing them properly may be thrown out of the opening. Such an opening also presents a potential for injury for occupants wearing their seat belts properly as entire body parts or portions of them may protrude from the passenger compartment.

When leaving the vehicle, always remove the SmartKey or SmartKey with KEYLESS-GO* from the starter switch, take it with you, and lock the vehicle. Do not leave children unattended in the vehicle, or with access to an unlocked vehicle. A child's unsupervised access to a vehicle could result in an accident and/or serious personal injury.

Power tilt/sliding sunroof* (Coupe)

! To avoid damaging the seals, do not transport any objects with sharp edges which can stick out of the tilt/sliding sunroof.

Do not open the tilt/sliding sunroof if there is snow or ice on the roof, as this could result in malfunctions.

The tilt/sliding sunroof can be opened or closed manually should an electrical malfunction occur (▷ page 430).



! Please keep in mind that weather conditions can sometimes change rapidly. Make sure to close the tilt/sliding sunroof when leaving the vehicle. If water enters the vehicle interior, vehicle electronics could be damaged which is not covered by the Mercedes-Benz Limited Warranty.

i When the tilt/sliding sunroof is open, resonance noises may result in addition to the usual wind noises. They are caused by minimal pressure changes in the passenger compartment. To reduce or eliminate these noises, change the position of the tilt/sliding sunroof or open a side window slightly.

i You can also open or close the tilt/sliding sunroof using the:

- SmartKey (summer opening/convenience feature) (▷ page 253)

Depending on current position, the tilt/sliding sunroof may also open or close when:

- the air recirculation button  in the control panel of the climate control (▷ page 191) or automatic climate control (▷ page 201) is pressed and held or
 - the charcoal filter button  in the control panel of the automatic climate control (▷ page 201) is pressed and held.
- ▶ Switch on the ignition (▷ page 40).

Opening and closing the power tilt/sliding sunroof

- ▶ To open, close, raise, or lower the tilt/sliding sunroof, move the sunroof switch to resistance point in the required direction of arrows ① to ④.

Release the sunroof switch when the tilt/sliding sunroof has reached the desired position.

Fully opening (Express-open) and closing (Express-close) the power tilt/sliding sunroof

- ▶ To open, close, raise, or lower the tilt/sliding sunroof, move the sunroof switch past the resistance point in the required direction of arrow ① to ④ and release.

The tilt/sliding sunroof opens or closes completely.

Power tilt/sliding sunroof* (Coupe)

Stopping the power tilt/sliding sunroof during Express-operation

- ▶ Move the sunroof switch in any direction.

i *If the movement of the tilt/sliding sunroof is blocked during the Express-close procedure, the tilt/sliding sunroof will stop and re-open slightly.*

Synchronizing the power tilt/sliding sunroof

The tilt/sliding sunroof must be synchronized each time after:

- the battery has been disconnected or discharged
- the tilt/sliding sunroof has been closed manually (▷ page 430)
- the tilt/sliding sunroof does not open smoothly
- a malfunction

- ▶ Switch on the ignition (▷ page 40).
- ▶ Move and hold the sunroof switch in the direction of arrow ① (▷ page 256) until the tilt/sliding sunroof is fully raised at the rear.

Hold the sunroof switch for approximately one second.

- ▶ Check the Express-open feature (▷ page 257).

If the tilt/sliding sunroof opens completely, the tilt/sliding sunroof is synchronized. Otherwise repeat the above steps.

▼ Soft top (Cabriolet)

Opening and closing the soft top

For safety reasons, the soft top can only be opened and closed when the vehicle is standing still.

Warning!



Before operating the switch for the soft top, make sure no persons can be injured by the moving parts (roll bars, soft top frame, and soft top compartment cover).

Hands must never be placed near the roll bar, soft top frame, upper windshield area, shelf behind roll bar, or soft top storage compartment while the soft top is being raised or lowered. Serious personal injury may occur.

If potential danger exists, release the soft top switch. This immediately interrupts the raising or lowering procedure. You then can operate the soft top switch to raise or lower the soft top away from the danger zone.

Warning!



When leaving the vehicle, always remove the SmartKey or SmartKey with KEYLESS-GO* from the starter switch, take it with you, and lock the vehicle. Do not leave children unattended in the vehicle, or with access to an unlocked vehicle. A child's unsupervised access to a vehicle could result in an accident and/or serious personal injury.

! *Never sit or place heavy objects on the rear shelf. Doing so could cause damage to the soft top and the rear shelf.*

! *Please keep in mind that weather conditions can sometimes change rapidly. Make sure to close the soft top when leaving the vehicle. If water enters the vehicle interior, vehicle electronics could be damaged which is not covered by the Mercedes-Benz Limited Warranty.*

! *When opening and closing the soft top, make sure:*

- *there is sufficient clearance for the soft top to move up*
- *the luggage cover is engaged in place (▷ page 264)*
- *the trunk is only loaded to the height of the luggage cover*
- *the luggage/cargo does not push the closed luggage cover up*
- *the trunk lid is closed*
- *nothing is placed on the soft top compartment cover*
- *the outside temperature is above +5°F (-15°C)*

Otherwise the soft top and other parts of the vehicle could be damaged.

Soft top (Cabriolet)

Opening the soft top

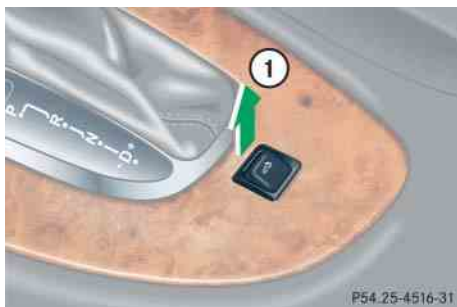

① Soft top, opening

Before pulling on the soft top switch, you must make sure:

- the parking brake is engaged (▷ page 59)
- the luggage cover is latched, see “Latch luggage cover” (▷ page 264)
- the trunk lid is closed
- the ignition is switched on (▷ page 38)

i The soft top cannot be opened using the soft top switch when the roll bars have been re-released. The roll bars need to be lowered before the soft top can be operated again using the soft top switch. If the roll bars have released and the soft top is closed, contact an authorized Mercedes-Benz Center to have the roll bars lowered. Do not attempt to lower the roll bars manually with the soft top closed. Lowering the roll bars manually with the soft top closed may impair the function of the roll bars (▷ page 82).

If the roll bars have released and the soft top is open, you can lower the roll bars manually (▷ page 431) or contact an authorized Mercedes-Benz Center to have the roll bars lowered.

- ▶ Pull up on the soft top switch as indicated by the arrow ① until the soft top is completely lowered into its trunk storage compartment.

During the opening procedure the multifunction display shows the message Top In Operation.

If you continuously pull on the soft top switch, the windows will close.

However, the windows can also be closed/opened later on, for more information see “Opening and closing all side windows with the soft top switch (CLK cabriolet)” (▷ page 255), or see “Opening and closing the windows” (▷ page 250).

i For safety reasons, the soft top cannot be opened while driving.

Make sure the soft top is dry before you open it. Otherwise water may enter the trunk interior.

! To prevent mildew, the soft top must be dry before lowering it into the storage compartment.

Do not lower a frozen soft top until thawed and dry. Lowering a frozen soft top may result in damage not covered by the Mercedes-Benz Limited Warranty.

Warning!



Do not place anything on the soft top compartment cover.

The soft top compartment cover must never be used by any persons as a seat bench.

Raising of the roll bars could result in serious personal injury.

Closing the soft top

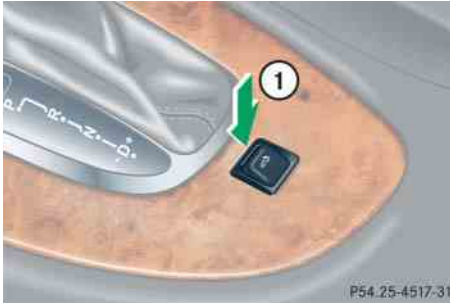

① Soft top, closing

Before pressing the soft top switch, you must make sure:

- the parking brake is engaged (▷ page 59)
- the trunk lid is closed
- the ignition is switched on (▷ page 38)

- ▶ Press the soft top switch as indicated by the arrow ① until the soft top is completely closed and locked.

During the closing procedure the multifunction display shows the message Top In Operation.

If you continuously press on the soft top switch the windows will close.

However, the windows can also be closed/opened later on, for more information see “Opening and closing all side windows with the soft top switch (CLK cabriolet)” (▷ page 255) or see “Opening and closing the windows” (▷ page 250).

- ⓘ *For safety reasons, the soft top cannot be closed while driving.*

- ⓘ *The soft top cannot be closed using the soft top switch when the roll bars have been released. The roll bars need to be lowered before the soft top can be operated again using the soft top switch. If the roll bars have released and the soft top is open, you can lower the roll bars manually (▷ page 431) or contact an authorized Mercedes-Benz Center to have the roll bars lowered.*

Warning!



To prevent possible accidents, drive the vehicle only with the soft top either completely closed and locked, or fully lowered into its storage compartment.

If the soft top does not completely open or close, a warning sounds. In the multifunction display you will see , and the message Open/Close Top Completely appears. After about 15 seconds the roof hydraulics lose pressure if the ignition is switched off.

Properly lock the soft top (▷ page 262) before continuing to drive.

Soft top (Cabriolet)

Locking the soft top after raising/lowering

Warning!



The soft top is not fully closed and locked or not fully opened if:

- the message *Top In Operation* is shown in the multifunction display
- a warning sounds for 10 seconds when starting to drive

To prevent possible accidents, drive the vehicle only with the soft top either completely closed and locked, or fully lowered into its storage compartment.

If the soft top is not properly locked, lock it as described below.

Unlocked status noticed when stopped

- ▶ Switch on the ignition (▷ page 38).
- ▶ To lock the soft top in its fully closed position, press soft top switch.

or:

- ▶ To lock the soft top in its fully opened position, pull up on the soft top switch.

Unlocked status noticed while driving

Warning!



Stop the vehicle in a safe location or as soon as it is safe to do so and lock the soft top before continuing to drive. You could otherwise endanger yourself and others.

- ▶ Stop the vehicle.
- ▶ Leave the ignition switched on.
- ▶ To lock the soft top in its fully closed position, press soft top switch.

or:

- ▶ To lock the soft top in its fully opened position, pull up on the soft top switch.

Warning!



If the soft top does not completely open or close, the roof hydraulics will lose pressure and the soft top will lower

- after approximately seven minutes when the ignition is switched on.
- after approximately 15 seconds when the ignition is switched off.

Shortly before the soft top is lowered, a warning will sound. In the multifunction display you will see , and the message *Top Lowering* appears.

- Properly lock the soft top (▷ page 262) before continuing to drive.

Opening and closing the soft top with the SmartKey



The windows will also be opened or closed when you operate the soft top with the SmartKey.

Warning!



Before operating the soft top, make sure no persons can be injured by the moving parts (roll bar, soft top frame, and soft top compartment cover) due to negligence.

Hands must never be placed near the roll bar, soft top frame, upper windshield area, shelf behind roll bar, or soft top storage compartment while the soft top is being raised or lowered. Serious personal injury may occur.

If potential dangers exists, release the respective button on the SmartKey. This immediately interrupts the raising or lowering procedure. You then can operate  to lower or  to raise the soft top away from the danger zone.



- ▶ Aim transmitter eye of the SmartKey or SmartKey with KEYLESS-GO* at the driver's outside door handle. The SmartKey or SmartKey with KEYLESS-GO* must be in close proximity to the driver's outside door handle.

Opening (Summer opening feature)

- ▶ Press and hold button  until the soft top is completely open.

The windows and soft top begin to open after approximately one second.

During the opening procedure the multifunction display shows the message Top In Operation.

- ▶ Release transmit button  to interrupt procedure.

Make sure the soft top is fully opened.

Closing (Convenience feature)

- ▶ Press and hold button  until the soft top is completely closed.

The windows and soft top begin to close after approximately one second.

During the closing procedure the multifunction display shows the message Top In Operation.

- ▶ Release transmit button  to interrupt procedure.

Soft top (Cabriolet)

Make sure all side windows and the soft top are properly closed before leaving the vehicle.

Warning!



If the soft top does not completely open or close, a warning sounds and the soft top switch flashes. In the multifunction display you will see , and the message **Open/Close Top Completely** appears. After about 15 seconds the roof hydraulics lose pressure.

Properly lock the soft top (▷ page 262) before continuing to drive.

Luggage cover

The luggage cover is located in the trunk.

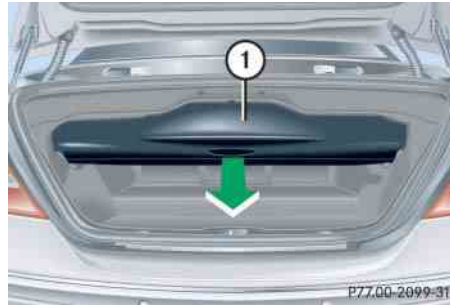

① Luggage cover

- ▶ Open the trunk

Latch luggage cover

- ▶ Pull luggage cover ① out in direction of arrow until it engages in place.

Folding back luggage cover

- ▶ Press luggage cover ① in direction of rear seat.

! To prevent damage to the soft top or luggage/cargo when lowering the roof:

- load trunk only to the height of the luggage cover
- do not permit luggage/cargo to push up the closed luggage cover
- do not place anything on the shelf behind the roll bars
- do not place anything on the soft top compartment cover

! Never place anything behind the side nets when the luggage cover has been folded back. You could forget about objects placed there, which could result in damage when operating the soft top.

Wind screen

Warning!



The wind screen can restrict the driver's vision to the rear of the vehicle. To prevent a possible accident when visibility is limited (e.g. in darkness), the upper part of the wind screen should be folded back.

The wind screen deflects drafts away from the driver and passenger when the soft top is lowered. It is stored in a separate storage bag in the trunk.

Installing

- ▶ Remove the wind screen from its storage bag.



- ① Upper section
- ② Lower section
- ▶ Fold sections ① and ② together.



- ③ Catch
- ④ Retainer claw
- ⑤ Snap fastener

- ▶ Press retainer claw ④ on upper section into snap fastener ⑤ of lower section. ▷▷

Soft top (Cabriolet)

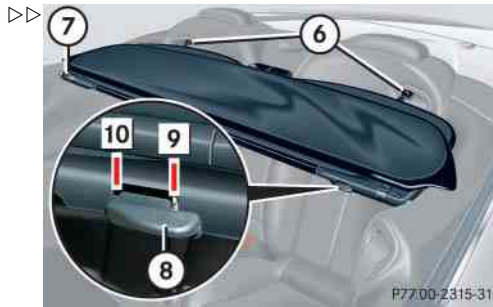

- ⑥ Retaining lugs
- ⑦ Mounting fixture on right side
- ⑧ Catch
- ⑨ Locking
- ⑩ Unlocking

- ▶ Fold retaining lugs ⑥ out.
- ▶ Slide pre-assembled wind screen into mounting fixture on right side ⑦ using retaining pin on right side. Simultaneously, retaining lugs ⑥ should slide into seat belt passage in rear bench seat.

- ▶ Pull catch ⑧ in position ⑨ and guide left retaining pin into mounting fixture on left side.
- ▶ Fold upper section of wind screen up toward head restraints until it stops.

Warning!



Check for secure locking by pulling up on the wind screen.

To prevent personal injury, remove wind screen if rear seats are to be occupied by passengers.

Removing

- ▶ Fold upper section of wind screen back down.
- ▶ Pull catch ⑧ in position ⑩ and pull wind screen out toward front of vehicle. Be careful not to damage interior trim with guide tabs.
- ▶ Fold retaining lugs ⑥ back.



⑪ Catch

- ▶ Press catch ⑪ to the right and fold upper and lower sections back.
- ▶ Place the wind screen back into the bag.

▼ Driving systems

The driving systems of your vehicle are described on the following pages:

- Cruise control, with which the vehicle can maintain a preset speed.
- Parktronic* (CLK 63 AMG (USA), Canada all vehicles), which serves as a parking assistant.

For information on the BAS, ABS, and ESP®, see “Driving safety systems” (▷ page 90).

Cruise control

Cruise control automatically maintains the speed you set for your vehicle.

Use of cruise control is recommended for driving at a constant speed for extended periods of time.

You can set or resume cruise control at any speed over 20 mph (30 km/h).

The cruise control function is operated by means of the cruise control lever.

The cruise control lever is the uppermost lever on the left-hand side of the steering column (▷ page 26).

Warning!



Cruise control is a convenience system designed to assist the driver during vehicle operation. The driver is and must always remain responsible for the vehicle's speed and for safe brake operation.

Only use cruise control if the road, traffic and weather conditions make it advisable to travel at a steady speed.

- The use of cruise control can be dangerous on winding roads or in heavy traffic because conditions do not allow safe driving at a steady speed.
- The use of cruise control can be dangerous on slippery roads. Rapid changes in tire traction can result in wheel spin and loss of control.
- Deactivate cruise control when driving in fog.

The “Resume” function should only be operated if the driver is fully aware of the previously set speed and wishes to resume this particular preset speed.

Driving systems



- ① Set current or higher speed
- ② Set current or lower speed
- ③ Cancel cruise control
- ④ Resume to last set speed

Warning!



Cruise control brakes automatically so that the set speed is not exceeded. The brake pedal depresses when the cruise control engages the brakes.

Keep driver's foot area clear at all times, including the area under the brake pedal. Objects stored in this area may impair pedal movement which could interfere with the braking ability of the cruise control system.

Do not place your foot under the brake pedal - your foot could become caught.

Keep in mind that cruise control is a convenience system designed to assist the driver during vehicle operation. The driver is and must always remain responsible for the vehicle's speed and for safe brake operation.

Setting current speed

- ▶ Accelerate or decelerate to the desired speed.
- ▶ Briefly lift ① or depress ② the cruise control lever.

The current speed is set.

- ▶ Remove your foot from the accelerator pedal.

Cruise control is activated.

The selected speed appears in the multi-function display for approximately five seconds, and the corresponding speedometer segments from the selected speed to the vehicle maximum speed are illuminated.

i *On uphill or downhill grades, cruise control may not be able to maintain the set speed. Once the grade eases, the set speed will be resumed.*

On downhill grades, the cruise control will hold the set speed with braking from the vehicle's brake system.

In addition, on longer downhill grades the automatic transmission will automatically downshift.

Canceling cruise control

There are several ways to cancel cruise control:

- ▶ Step on the brake pedal.

Cruise control is canceled. The last speed set is stored for later use.

or

- ▶ Briefly push the cruise control lever to position ③.

Cruise control is canceled. The last speed set is stored for later use.

i The last stored speed is canceled when you turn off the engine.

i Cruise control automatically switched off, if

- you step on the brake pedal.
- you press the parking brake pedal.

In this case the segments in the multifunction display (▷ page 268) go out and no warning sounds.

- the vehicle speed is below 20 mph (30 km/h).
- ESP® is in operation or switched off with the ESP® switch (▷ page 94).
- you move the gear selector lever in position **N** while driving.

The segments in the multifunction display (▷ page 268) go out, and an acoustic warning sounds.

! Moving gear selector lever to position **N** while driving also cancels cruise control. However, the gear selector lever should not be moved to position **N** while driving except to coast when the vehicle is in danger of skidding (e.g. on icy roads).

i Depressing the accelerator pedal does not deactivate cruise control. After brief acceleration (e.g. for passing), cruise control will resume the last speed set.

Setting a higher speed

Warning!



If you increase the set vehicle speed, keep in mind that it may take a brief moment until the vehicle has made the necessary adjustments.

Increase the set vehicle speed to a value that the prevailing road conditions and legal speed limits permit. Otherwise, sudden and unexpected acceleration of the vehicle could cause an accident and/or serious injury to you and others.

- ▶ Lift cruise control lever in the direction of arrow ① and hold it up until the desired speed is reached.
- ▶ Release the cruise control lever.
The new speed is set.

Setting a lower speed

Warning!



If you decrease the set vehicle speed, keep in mind that it may take a brief moment until the vehicle has made the necessary adjustments.

Decrease the set vehicle speed to a value that the prevailing road conditions and legal speed limits permit. Otherwise, sudden and unexpected deceleration of the vehicle could cause an accident and/or serious injury to you and others.

- ▶ Depress cruise control lever in the direction of arrow ② and hold it down until the desired speed is reached.
- ▶ Release the cruise control lever.

The new speed is set.

i When you use the cruise control lever to decelerate, the brake system will automatically brake the vehicle if the engine's braking power does not brake the vehicle sufficiently.

Fine adjustment in 1 mph (Canada: 1 km/h) increments

Faster

- ▶ Briefly tip cruise control lever in the direction of arrow ①.

Slower

- ▶ Briefly tip cruise control lever in the direction of arrow ②.

Setting to last stored speed ("Resume" function)

Warning!



The speed stored in memory should only be set again if prevailing road conditions permit. Possible acceleration or deceleration differences arising from returning to the preset speed could cause an accident and/or serious injury to you and others.

- ▶ Briefly push cruise control lever in the direction of arrow ④.
The cruise control resumes the last set speed.
- ▶ Remove your foot from the accelerator pedal.

The selected speed appears in the multi-function display for approximately five seconds, and the corresponding speedometer segments from the selected speed to the vehicle maximum speed are illuminated (▷ page 268).

Parktronic system (Parking assist)*, CLK 63 AMG (USA), Canada all models

Warning!



Parktronic is a supplemental system. It is not intended to, nor does it replace, the need for extreme care. The responsibility during parking and other critical maneuvers always remains with the driver.

Interference caused by other ultrasonic signals (e.g. working jackhammers, car wash, or the air brakes of trucks) can cause the system to send erratic indications, and should be taken into consideration.

! *Special attention must be paid to objects with smooth surfaces or low silhouettes (e.g. trailer couplings, painted posts, elevated cross-bars or road curbs). Such objects may not be detected by the system and can damage the vehicle.*

Warning!



Make sure no persons or animals are in the area in which you are maneuvering. You could otherwise injure them.

! *The operational function of the Parktronic system can be affected by dirty sensors, especially at times of snow and ice.*

Make sure that the area on the bumpers around the sensors is free of dirt, ice and/or slush, otherwise Parktronic may not function properly, see "Cleaning the Parktronic system sensors (CLK 63 AMG (USA), Canada all vehicles)" (▷ page 372).*

The Parktronic system is an electronic aid designed to assist the driver during parking maneuvers. It visually and audibly indicates the relative distance between the vehicle and an obstacle.

The Parktronic system is automatically activated when you switch on the ignition (▷ page 38) and placed the gear selector lever in position **D**, **R**, or **N**.

The Parktronic system deactivates at speeds over approximately 11 mph (18 km/h). At lower speeds the Parktronic system turns on again.

The Parktronic system also deactivates when you place the gear selector lever in position **P**.

The Parktronic system monitors the surroundings of your vehicle with six sensors in the front bumper and four sensors in the rear bumper.

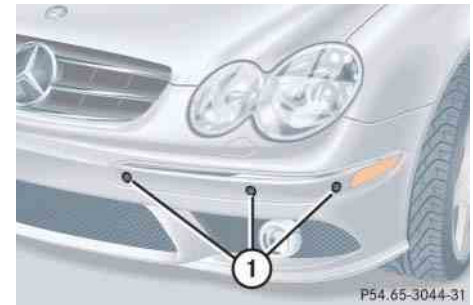

① Sensors in the front bumper

Driving systems

Range of the sensors

To function properly, the sensors must be free of dirt, ice, snow and slush. Clean the sensors regularly, being careful not to scratch or damage the sensors, see “Cleaning the Parktronic system* sensors (CLK 63 AMG (USA), Canada all vehicles)” (▷ page 372).

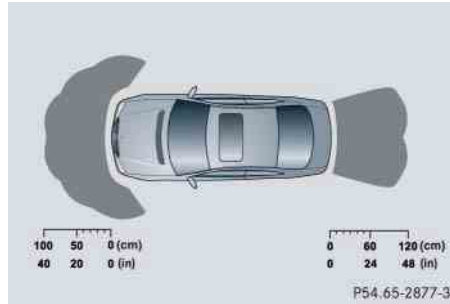
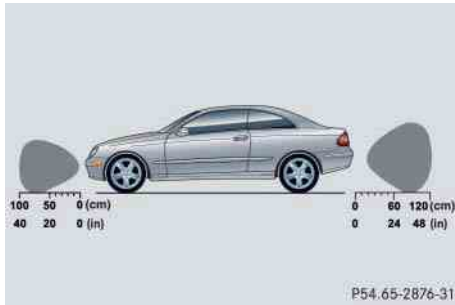

Front sensors

Center	approx. 40 in (100 cm)
Corners	approx. 24 in (60 cm)

Rear sensors

Center	approx. 48 in (120 cm)
Corners	approx. 32 in (80 cm)

! During parking maneuvers, pay special attention to objects located above or below the height of the sensors (e.g. planters or trailer hitches). The Parktronic system will not detect such objects at close range and damage to your vehicle or the object may result.

Ultrasonic signals from outside sources (e.g. truck air brakes, car wash, or jackhammers) may impair the operation of the Parktronic system.

Minimum distance

Center	approx. 8 in (20 cm)
Corners	approx. 6 in (15 cm)

If the system detects an obstacle in this range, all the distance warning segments illuminate and you hear a warning signal. If the obstacle is closer than the minimum distance, the actual distance may no longer be indicated by the system.

Warning indicators

Visual signals indicate to the driver the relative distance between the sensors and an obstacle. The warning indicator for the front area is located above the center air vents in the dashboard.

CLK coupe:

The warning indicator for the rear area is integrated in the rear dome lighting.

CLK cabriolet:

The warning indicator for the rear area is integrated between the rear backrests.



- ① Left side of the vehicle
- ② Right side of the vehicle

Each warning indicator is divided into six yellow and two red distance segments for either side of the vehicle. The Parktronic system is ready when the border around the indicator is illuminated.

The position of the gear selector lever determines which warning indicators will be activated.

Gear selector lever position	Warning indicator
D	Front area activated
R or N	Front and rear area activated
P	Neither activated

As your vehicle approaches an object, one or more distance segments will illuminate, depending on the distance. When the eighth distance segment illuminates, you have reached the minimum distance.

- **Front area:** An intermittent acoustic warning will sound as the first red distance segment illuminates and a constant acoustic warning lasting a maximum of two seconds will sound for the second red distance segment. The signal is canceled when the gear selector lever is placed in position **P**.
- **Rear area:** An intermittent acoustic warning will sound as the first red distance segment illuminates and a constant acoustic warning lasting a maximum of two seconds will sound for the second red distance segment. The signal is canceled when the gear selector lever is placed in position **D** or **P**.

Driving systems

Switching the Parktronic system on/off

The Parktronic system can be switched off manually.

The Parktronic switch is located in the upper part of the center console.



- ① Parktronic switch
- ② Indicator lamp

Switching off the Parktronic system

- ▶ Press Parktronic switch ①.
- Indicator lamp ② comes on.

Switching on the Parktronic system

- ▶ Press Parktronic switch ① again.
- Indicator lamp ② goes out.

i The Parktronic system is automatically switched on when the ignition is switched on (▷ page 38).

Parktronic system malfunction

If only the red distance segments illuminate and a acoustic warning sounds, there is a malfunction in the Parktronic system. The Parktronic system will automatically switch off after 20 seconds and the indicator lamp in the Parktronic switch comes on.

- ▶ Have the Parktronic system checked at an authorized Mercedes-Benz Center as soon as possible.

If only the red distance segments illuminate and no acoustic warning sounds, the Parktronic system sensors are dirty or there is an interference from other radio or ultrasonic signals. The Parktronic system will automatically switch off after 20 seconds and the indicator lamp in the Parktronic switch comes on.

- ▶ Switch off the ignition (▷ page 38).
 - ▶ Clean the Parktronic system sensors (▷ page 372).
 - ▶ Switch on the ignition.
- or
- ▶ Check the Parktronic system operation at another location to rule out interference from outside radio or ultrasonic signals.

▼ Loading

Roof rack (CLK coupe only)

Warning!

Only use roof racks approved by Mercedes-Benz for your vehicle model to avoid damage to the vehicle.

Follow the manufacturer's installation instructions. Otherwise, an improperly attached roof-rack system or its load could become detached from the vehicle.

Do not exceed the maximum roof load of 220 lbs (100 kg).

Take into consideration that when the roof rack is loaded, the handling characteristics are different from those when operating the vehicles without the roof rack loaded.

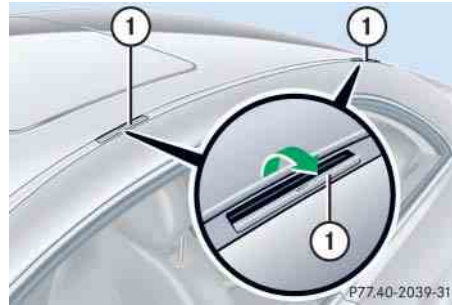

① Trim cover

! Load the roof rack in such a way that the vehicle cannot be damaged while driving.

Make sure

- you can fully raise the tilt/sliding sunroof*
- you can fully open the trunk

Preparing roof rack installation

- ▶ Open trim covers ① at the trim strips in the roof.
- ▶ Only attach the roof-rack system to the anchorage points under the trim covers ①.

Observe manufacturer's instructions for installation.

Loading

Ski bag* (Canada only)

Unfolding ski bag (CLK cabriolet)

- ▶ Close soft top completely (▷ page 261).
- ▶ Open the trunk.



- ▶ Fold luggage cover back in direction of the arrow.

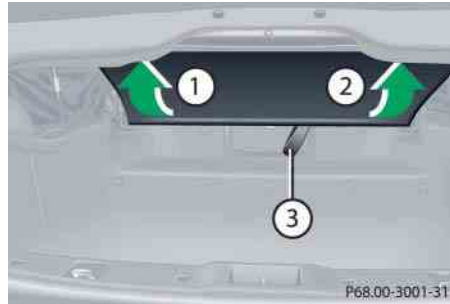

- ① Left hinge
- ② Right hinge
- ③ Pull strap

- ▶ Pull ski bag roller blind upward using pull strap ③.
- ▶ Manually fold left ① and right hinges ② of ski bag roller blind all the way up.



- ④ Handle
- ⑤ Cover
- ⑥ Armrest

- ▶ Fold armrest ⑥ down (arrow).
- ▶ Pull handle ④ and swing cover ⑤ down.



⑦ Hook and loop fastener

- ▶ Unfasten hook and loop fastener ⑦.
- ▶ Pull ski bag into passenger compartment and unfold.

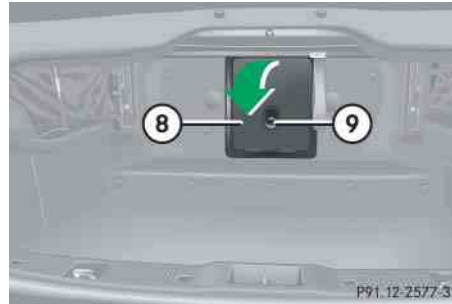

⑧ Flap

⑨ Catch

- ▶ Pull down catch ⑨.
- ▶ Open the flap ⑧ downwards in the direction of the arrow.

Unfolding ski bag (CLK coupe)



① Handle

② Cover

③ Armrest

- ▶ Fold armrest ③ down (arrow).
- ▶ Pull handle ① and swing cover ② down.



Loading



④ Hook and loop fastener

- ▶ Unfasten hook and loop fastener ④.
- ▶ Pull ski bag into passenger compartment and unfold.

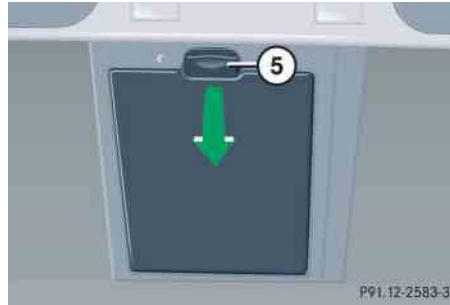

⑤ Button

- ▶ Open the trunk.
- ▶ Press button ⑤.
The flap opens downward.

Loading



- ▶ From trunk, slide skis into ski bag.

Warning!



The ski bag is designed for up to four pairs of skis in the CLK coupe and for two pairs of skis in the CLK cabriolet. Do not load the ski bag with other objects.

Always fasten the ski bag securely. In an accident, an unfastened ski bag can cause injury to vehicle occupants.



⑥ Strap

- ▶ Tighten strap ⑥ by pulling at the loose end (arrow) until the skis in the ski bag are tightly secured.

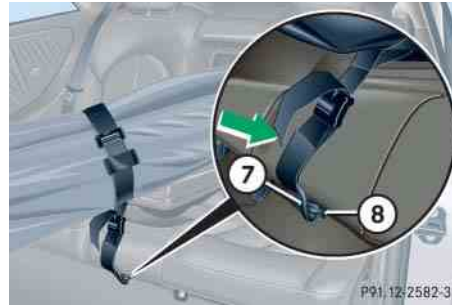

⑦ Hook

⑧ Eye

- ▶ Connect hook ⑦ to eye ⑧ located on center tunnel in front of rear seat bench.
- ▶ Tighten strap by pulling at the loose end (arrow).

Unloading and folding

- ▶ Loosen both straps.
- ▶ Disconnect hook ⑦ from eye ⑧.
- ▶ Unload skis.
- ▶ Close flap in trunk.
- ▶ Fold and flatten ski bag lengthwise.
- ▶ Place folded ski bag inside recess of backrest.
- ▶ Fasten hook and loop fastener.



- ▶ Close ski bag compartment cover.

Loading

Closing ski bag roller blind

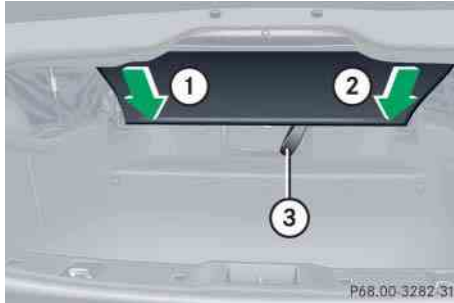

- ① Left hinge
- ② Right hinge
- ③ Pull strap

- ▶ Pull ski bag roller blind downward using pull strap ③.
- ▶ Manually fold left ① and right hinges ② of ski bag roller blind all the way down.
- ▶ To snap ski bag roller blind into place, press left and right hinges where the word PRESS can be seen.
- ▶ Fold luggage cover back and close it securely (▷ page 264).

Removing the ski bag

CLK cabriolet

For ski bag removal, we recommend that you contact an authorized Mercedes-Benz Center.

Warning!



Never drive vehicle with trunk open while the ski bag is removed. Deadly carbon monoxide (CO) gases may enter vehicle interior, resulting in unconsciousness and death.

i To prevent unauthorized persons from access to the trunk, always close the flap.

CLK coupe

You can remove the ski bag for cleaning or drying.



- ① Button
- ② Ski bag frame
- ③ Flap

- ▶ Open trunk lid.
- ▶ Press button ①.
- ▶ The flap ③ opens downward.
- ▶ Press button ① firmly until ski bag frame ② is released.
- ▶ Pull ski bag frame ② with ski bag out.

Warning!

Never drive vehicle with trunk open while the ski bag is removed. Deadly carbon monoxide (CO) gases may enter vehicle interior, resulting in unconsciousness and death.

i To prevent unauthorized persons from access to the trunk, always close the flap.

Installing the ski bag

Install the ski bag in the reverse order.

- ▶ Push ski bag frame ② with ski bag inward until the ski bag frame snaps into place.
- ▶ Close flap ③.
- ▶ Close trunk lid.

Split rear bench seat (CLK coupe only)

To expand the cargo area, you can fold down the left and right rear seat backrests.

The two sections can be folded down separately.

Warning!

When expanding the luggage compartment, always fold the seat cushions fully forward.

Unless you are transporting cargo, the backrests must remain properly locked in the upright position.

In an accident, during hard braking or sudden maneuvers, loose items will be thrown around inside the vehicle, and cause injury to vehicle occupants unless the items are securely fastened in the vehicle.

Always use the cargo tie down rings (▷ page 284).

Folding the backrest forward

The release handle ① is located in the trunk.

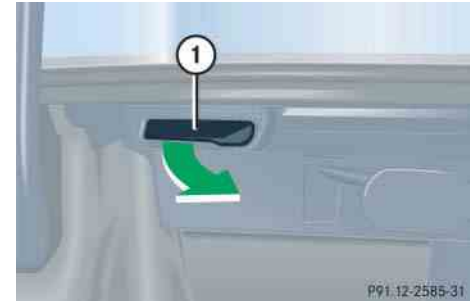

① Release handle

- ▶ Pull release handle ①.
- ▶ Fully retract and fold rearward head restraint (▷ page 121). ▷▷

Loading

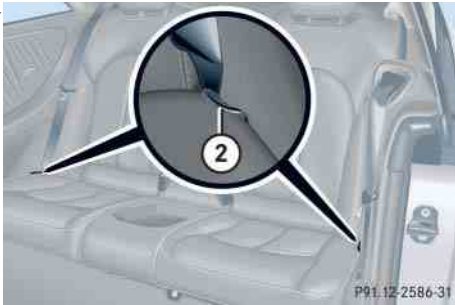

- ② Release handle
- ▶ Pull release handle ②.



- ③ Seat cushion
- ④ Seat backrest
- ▶ Fold seat cushion ③ forward.
- ▶ Fold rear seat backrest ④ forward.

! Always release the seat cushion and fold it forward before folding the corresponding seat backrest forward. The covering on the seat backrest may otherwise be damaged.

Setting up rear seat bench



- ⑤ Indicator right
- ⑥ Indicator left
- ▶ Fold backrest ④ (▷ page 282) rearward until it engages.
- ▶ Fold seat cushions ③ (▷ page 282) rearward until it locks into position.

If a backrest is not locked into position, a red indicator ⑤ or ⑥ will be visible.

- ▶ Check for secure locking by pushing and pulling on the backrest.

Warning!

If a red indicator is visible with the backrest up, then the backrest is not properly locked into position.

Always lock backrest in its upright position when rear seat bench is occupied, or the extended trunk compartment is not in use. Check for secure locking by pushing and pulling on the backrest.

In an accident, during hard braking or sudden maneuvers, loose items will be thrown around inside the vehicle, and cause injury to vehicle occupants unless the items are securely fastened in the vehicle.

To help avoid personal injury during a collision or sudden maneuver, exercise care when transporting cargo.

i To prevent unauthorized persons from access to the trunk, always lock backrest in its upright position.

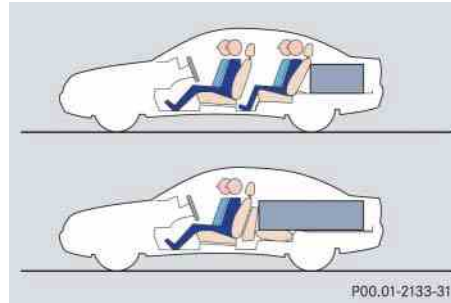
Loading instructions

The total load weight including vehicle occupants and luggage/cargo should not exceed the load limit indicated on the corresponding Tire and Loading Information placard located on the driver's door B-pillar (▷ page 334).

The handling characteristics of a fully loaded vehicle depend greatly on the load distribution. It is therefore recommended to load the vehicle according to the illustrations shown, with the heaviest items being placed towards the front of the vehicle.

Always place items being carried against front or rear seat backrests, and fasten them as securely as possible.

The heaviest portion of the cargo should always be kept as low as possible since it influences the handling characteristics of the vehicle.

! CLK cabriolet:

To prevent damage to the soft top or luggage/cargo when lowering the roof:

- load trunk only to the height of the luggage cover
- do not permit luggage/cargo to push up the closed luggage cover
- do not place anything on the shelf behind the roll bar
- do not place anything on the soft top compartment cover

Loading

Warning!



CLK coupe:

Always fasten items being carried as securely as possible using cargo tie-down rings and fastening materials appropriate for the weight and size of the load.

CLK cabriolet:

Always fasten items being carried as securely as possible using fastening materials appropriate for the weight and size of the load.

In an accident, during hard braking or sudden maneuvers, loose items will be thrown around inside the vehicle and can cause injury to vehicle occupants unless the items are securely fastened in the vehicle.

To help avoid personal injury during a collision or sudden maneuver, exercise care when transporting cargo. Put luggage or cargo in the trunk if possible.

Never drive vehicle with trunk open. Deadly carbon monoxide (CO) gases may enter vehicle interior resulting in unconsciousness and death.

i *The trunk is the preferred place to carry objects.*

CLK coupe: The enlarged cargo area should only be used for items which do not fit in the trunk alone.

Cargo tie-down rings (CLK coupe only)

The four cargo tie-down rings are located in the trunk.



Cargo tie-down rings

- ▶ Carefully secure cargo by applying even load on all rings with rope of sufficient strength to hold down the cargo.

Always follow loading instructions (▷ page 283).

▼ Useful features

Storage compartments

Warning!



Do not store any flammable substances inside the vehicle or in the trunk. Otherwise the flammable substances could ignite and start a fire inside the vehicle.

To help avoid personal injury during a collision or sudden maneuver, exercise care when storing objects in the vehicle. Put luggage or cargo in the trunk if possible. Do not pile luggage or cargo higher than the seat backs.

Parcel nets cannot secure hard or heavy objects.

Keep compartment lids closed. This will help to prevent stored objects from being thrown about and injuring vehicle occupants during an accident.

Glove box

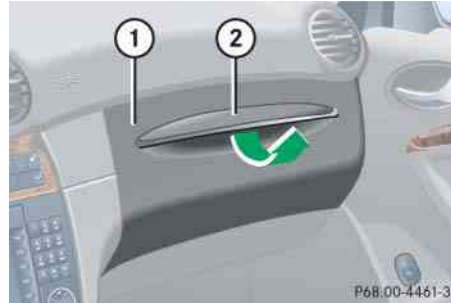

- ① Glove box lid
- ② Glove box lid release

Opening the glove box

- ▶ Pull glove box lid release ②.
- The glove box lid ① opens downward.

Closing the glove box

- ▶ Push glove box lid ① up to close.

i Audio system/COMAND* with CD changer*: The CD changer and the AUX-socket are located in the glove box.

Storage compartment in the dashboard



- ① Cover

Opening storage box

- ▶ Push cover ①.
- The storage box opens automatically.

Closing storage box

- ▶ Push the storage box back until it engages.

Useful features

Ruffled storage bags



Storage bags are located on the rear side of the front seats.

Warning!



The ruffled storage bag is intended for storing light-weight items only.

Heavy objects, objects with sharp edges or fragile objects may not be transported in the ruffled storage bag. In an accident, during hard braking, or sudden maneuvers, they could be thrown around inside the vehicle and cause injury to vehicle occupants.

The ruffled storage bag cannot protect transported goods in the event of an accident.

Parcel net in front passenger footwell

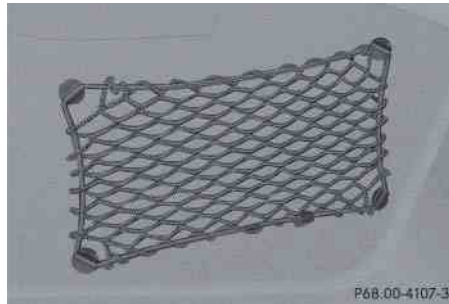

A small convenience parcel net is located in the front passenger footwell. It is for small and light items, such as road maps, mail, etc.

Warning!



The parcel net is intended for storing light-weight items only.

Heavy objects, objects with sharp edges or fragile objects may not be transported in the parcel net. In an accident, during hard braking, or sudden maneuvers, they could be thrown around inside the vehicle and cause injury to vehicle occupants.



The parcel net cannot protect transported goods in the event of an accident.

Center armrest

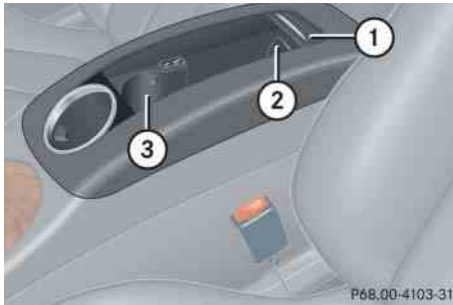
The compartment in the center armrest contains a cup holder and the telephone* compartment.



- ① Cover
- ② Telephone* compartment
- ③ Cup holder

i The Roadside Assistance button  (▷ page 298) and the Information button  (▷ page 299) are located below the cover ①.

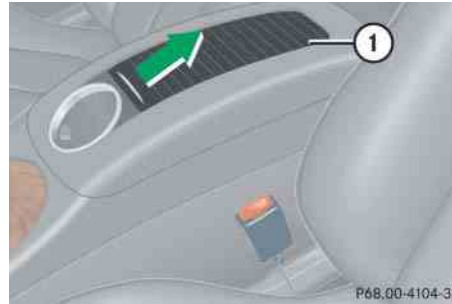

- ① Cover

Opening compartment

- ▶ Slide cover ① in direction of arrow.

Closing compartment

- ▶ Slide cover ① back.

Opening telephone compartment

- ▶ Slide cover ① in direction of arrow and open it fully.

Closing telephone compartment

- ▶ Slide cover ① back.

Armrest in the rear passenger compartment



- ▶ Pull the top of the armrest out and fold it down.

i CLK coupe: The armrest contains a cup holder (▷ page 288).

! Do not sit on or lean your full body weight against the armrest when it is folded down, as you could otherwise damage it.

Useful features

Cup holders

Warning!



In order to help prevent spilling liquids on vehicle occupants and/or vehicle equipment, only use containers that fit into the cup holder. Use lids on open containers and do not fill containers to a height where the contents, especially hot liquids, could spill during braking, vehicle maneuvers, or in an accident. Liquids spilled on vehicle occupants may cause serious personal injury. Liquids spilled on vehicle equipment may cause damage not covered by the Mercedes-Benz Limited Warranty.

When not in use, keep the cup holder closed. An open cup holder may cause injury to you and others when contacted during braking, vehicle maneuvers, or in an accident.

Keep in mind that objects placed in cup holder may come loose during braking, vehicle maneuvers, or in an accident and be thrown around in the vehicle interior. Objects thrown around in the vehicle interior may cause an accident and/or serious personal injury.

Cup holder in the center armrest

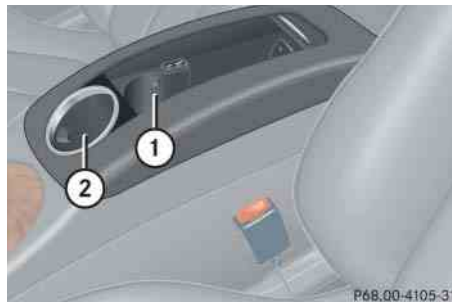

- ① Cup holder in compartment
(▷ page 287)
- ② Cup holder

Cup holder in rear seat armrest (CLK coupe only)



Opening cup holder

- ▶ Briefly press the front of cup holder.
The cup holder slides out slightly.
- ▶ Pull out the cup holder until it stops.

Closing cup holder

- ▶ Slide cup holder back in the direction of arrow ① until it engages.

Ashtrays

Center console ashtray



- ① Cover plate
- ② Sliding button
- ③ Ashtray insert

Opening ashtray

- ▶ Briefly press the bottom of cover plate ①.
The cover plate opens automatically.

Removing ashtray insert

Warning!



Remove front ashtray only with vehicle standing still. Set the parking brake to secure vehicle from movement. Move the gear selector lever to position **N** and turn off the engine.

- ▶ Secure vehicle from movement by setting the parking brake.
- ▶ Move the gear selector lever to position **N**.
Now you have more room to take out the insert.
- ▶ Push sliding button ② to the right.
The ashtray is disengaged and slides a short way in the direction of arrow ③.
- ▶ Remove the ashtray insert.

Reinstalling the ashtray insert

- ▶ Push the ashtray insert ③ down into the retainer until it engages.
- ▶ Push down cover plate ① to close the ashtray.
The cover plate engages.

Rear seat ashtray

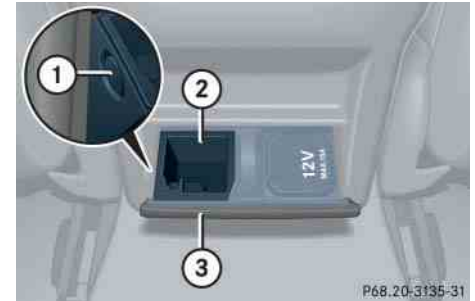

- ① Button
- ② Ashtray insert
- ③ Cover

Opening ashtray

- ▶ Pull at top of cover ③.

Useful features

Removing ashtray insert

- ▶ Push button ① to disengage ashtray insert ② and remove it.

Reinstalling ashtray insert

- ▶ Push the ashtray insert ② down into the retainer until it engages.
- ▶ Push at top of cover ③ to close ashtray.

Cigarette lighter

Warning!



Never touch the heating element or sides of the cigarette lighter; they are extremely hot. Hold the knob only.

Make sure any children traveling with you do not injure themselves or start a fire with the hot cigarette lighter.

When leaving the vehicle, always remove the SmartKey or SmartKey with KEYLESS-GO* from the starter switch, take it with you,

and lock the vehicle. Do not leave children unattended in the vehicle, or with access to an unlocked vehicle. A child's unsupervised access to a vehicle could result in an accident and/or serious personal injury.

- ▶ Switch on the ignition (▷ page 40).



- ① Cover
- ② Cigarette lighter

- ▶ Briefly press the bottom of cover plate ①.

The cover plate opens automatically.

- ▶ Push in cigarette lighter ②.

The cigarette lighter will pop out automatically when hot.

- ▶ Push down cover plate ① to close the ashtray.

The cover plate engages.

! The lighter socket can accommodate 12V DC electrical accessories (up to a maximum of 85 W) designed for use with the standard "cigarette lighter" plug type. Keep in mind, however, that connecting accessories to the lighter socket (for example extensive connecting and disconnecting, or using plugs that do not fit properly) can damage the lighter socket. With the socket damaged, the lighter may no longer be able to be placed in the heating (pushed-in) position, or the lighter may pop out too early with the lighter not hot enough.

To help avoid damaging the cigarette lighter socket, we recommend connecting 12V DC electrical accessories designed for use with the standard "cigarette lighter" plug type to the 12V power outlet (▷ page 291) in your vehicle whenever possible.

Power outlet in the rear passenger compartment



- ① Power outlet
- ② Cover
- ▶ Switch on the ignition (▷ page 38).
- ▶ Pull at top of cover ②.
- ▶ Flip cover ① to the left and insert electrical plug (cigarette lighter type).

i The power outlet can be used to accommodate electrical consumers (e.g. air pump, auxiliary lamps) up to a maximum of 180 W.

Floormats*

Warning!



Whenever you are using floormats, make sure there is enough clearance and that the floormats are securely fastened.

Floormats should always be securely fastened using eyelets ④ and retainer pins ⑤.

Before driving off, check that the floormats are securely in place and adjust them if necessary. A loose floormat could slip and hinder proper functioning of the pedals.

Do not place several floormats on top of each other as this may impair pedal movement.

i To install or remove the floormat more easily, move the driver's seat or front passenger seat as far to the rear as possible (▷ page 42).

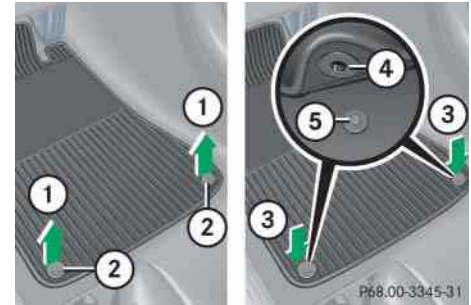

Removing

- ▶ Pull floormats off of retainer pins ② in the direction of arrow ①.
- ▶ Remove the floormats.

Installing

- ▶ Lay down the floormat.
- ▶ Press the floormat eyelets ④ onto retainer pins ⑤ in the direction of arrow ③.

Telephone*

Warning!



Never operate radio transmitters equipped with a built-in or attached antenna (i.e. without being connected to an external antenna) from inside the vehicle while the engine is running. Doing so could lead to a malfunction of the vehicle's electronic system, possibly resulting in an accident and/or serious personal injury.

Radio transmitters, such as a portable telephone or a citizens band unit, should only be used inside the vehicle if they are connected to an antenna that is installed on the outside of the vehicle.

The external antenna must be approved by Mercedes-Benz. Please contact an authorized Mercedes-Benz Center for information on the installation of an approved external antenna. Refer to the radio transmitter operation instructions regarding use of an external antenna.

Warning!



Please do not forget that your primary responsibility is to drive the vehicle. A driver's attention to the road must always be his/her primary focus when driving. For your safety and the safety of others, we recommend that you pull over to a safe location and stop before placing or taking a telephone call.

If you choose to use the telephone¹ while driving, please use the hands-free device and only use the telephone when road, weather and traffic conditions permit. Some jurisdictions prohibit the driver from using a mobile telephone while driving a vehicle.

Only operate the COMAND*¹ if road, weather and traffic conditions permit.



Bear in mind that at a speed of just 30 mph (approximately 50 km/h), your vehicle is covering a distance of 44 feet (approximately 14 m) every second.

¹ Observe all legal requirements.

i Various mobile phone cradles can be installed in the front center armrest, see separate installation instructions for the mobile phone cradle. These mobile phone cradles can be obtained from an authorized Mercedes-Benz Center.

The functions and services available to you while using the mobile phone depend on your service provider and the type of mobile phone you are using. See also separate operating manual for instructions on how to use your mobile phone.

When the mobile phone is inserted in the cradle, you can operate the telephone using the following devices:

- mobile phone keypad
- COMAND* (see separate operating instructions)
- buttons  and  on the multifunction steering wheel (▷ page 142)
- audio system (▷ page 236)

Please note that these functions are only available with Mercedes-Benz approved mobile phones. Please contact an authorized Mercedes-Benz Center for information on features available for your mobile phone of choice.

The cradle is located in the front center armrest.

- ▶ Open telephone compartment (▷ page 287).

Inserting mobile phone in mobile phone cradle

Once the mobile phone has been inserted in the mobile phone cradle, you have to use the hands-free device to respond during phone calls.

! Do not try to remove the mobile phone along with the cradle. You could otherwise damage the mobile phone cradle.

- ▶ If applicable, remove the cover for the external antenna connection from the back of the mobile phone and store it in a safe place. Be sure to comply with the mobile phone's operating instructions as well.



Example illustration

- ① Insert the mobile phone
 - ② Connector contact
 - ③ Mobile phone cradle
- ▶ Slide the lower end of the mobile phone into connector contact ② on cradle ③.

- ▶ Push the top of the mobile phone in direction of arrow ①, until the lug on the mobile phone release button engages.

The mobile phone is connected to the network via the external antenna.

The mobile phone is linked to the hands-free device and the multifunction steering wheel.

The battery is charged depending on its charge status and the position of the SmartKey in the starter switch. The charge procedure will be indicated in the mobile phone's display.

You can place or receive phone calls. You can control other functions of the mobile phone via the control system (▷ page 169), audio system (▷ page 236), COMAND* (see separate operating instructions).

i When you take the SmartKey or SmartKey with KEYLESS-GO* out of the starter switch, the mobile phone remains switched on for approximately 10 minutes. If you place or receive a call during this time, the mobile phone switches off 10 minutes after the call has been completed.

Useful features

Removing mobile phone from mobile phone cradle



Example illustration

- ① Release catch for mobile phone
- ② Mobile phone cradle

i When using a flip-style mobile phone, open flip top before removing from the cradle while a call is connected. Otherwise, the call will be disconnected.

- ▶ Press release catch in direction of arrow ① and take mobile phone out of mobile phone cradle ②.

Changing mobile phone cradle

If you require a different cradle for your mobile phone, remove the present cradle before installing a new one.

Removing an existing mobile phone cradle



Example illustration

- ① To release the mobile phone cradle
 - ② To remove the mobile phone cradle
 - ③ Mobile phone cradle
- ▶ Press release button in direction of arrow ① and take mobile phone cradle ③ out in direction of arrow ②.

Installing a different mobile phone cradle

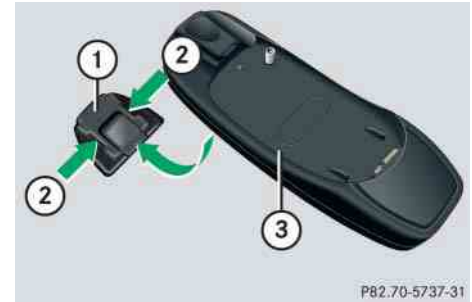

Example illustration

- ① Contact plate
 - ② Recesses
 - ③ Mobile phone cradle
- ▶ Insert mobile phone cradle ③ into recesses ② of contact plate ①.
 - ▶ Push mobile phone cradle ③ forward until it engages.

Tele Aid

! *The initial activation of the Tele Aid system may only be performed by completing the subscriber agreement and placing an acquaintance call using the  button. Failure to complete either of these steps will result in a system that is not activated.*

If you have any questions regarding activation, please call the Response Center at 1-800-756-9018 (in the USA) or 1-888-923-8367 (in Canada).



The Tele Aid system



(Telematic Alarm Identification on Demand)

The Tele Aid system consists of three types of response:



- automatic and manual emergency
- roadside assistance and
- information

The Tele Aid system is operational providing that the vehicle's battery is charged, properly connected, not damaged and cellular and GPS coverage is available.

The speaker volume of a Tele Aid call can be adjusted when using the volume control on the multifunction steering wheel. To raise, press button  and to lower, press button . The volume can also be adjusted using the volume knob on your audio system or COMAND* head unit.

- ▶ To activate, press the SOS button, the Roadside Assistance button  or the Information button , depending on the type of response required.



i *The SOS button is located in the overhead control panel (▷ page 33).*

The Roadside Assistance button  and the Information button  are located in the center armrest below the cover (▷ page 287).

Shortly after the completion of your Tele Aid acquaintance call, you will receive a user ID and password. By visiting www.mbusa.com and selecting "Tele Aid" (USA only), you will have access to account information, remote door unlock and more.

i *The Tele Aid system utilizes the cellular network for communication and the GPS (Global Positioning System) satellites for vehicle location. If either of these signals is unavailable, the Tele Aid system may not function and if this occurs, assistance must be summoned by other means.*

System self-check

Initially, after switching on the ignition, malfunctions are detected and indicated (the indicator lamps in the SOS button, the Roadside Assistance button  and the Information button  stay on longer than 10 seconds or do not come on). The message Tele Aid Inoperative appears in the multifunction display.

Warning!



If the indicator lamps in the SOS button, in the Roadside Assistance button and/or in the Information button remain illuminated constantly in red and/or message `Tele Aid Inoperative` is displayed in the multifunction display after the system self-check, a malfunction in the system has been detected.

If a malfunction is indicated as outlined above, the system may not operate as expected. Have the system checked at the nearest Mercedes-Benz Center as soon as possible.

Emergency calls

An emergency call is initiated automatically following an accident in which the emergency tensioning devices (ETDs) or air bags deploy.

An emergency call can also be initiated manually by opening the cover next to the interior rear view mirror labeled SOS, then briefly pressing the button located under the cover. See (▷ page 297) for instructions on initiating an emergency call manually.

Once the emergency call is in progress, the indicator lamp in the SOS button will begin to flash. The message `Connecting Call` appears in the multifunction display and the audio system is muted. When the connection is established, the message `Call Connected` appears in the multifunction display. All information relevant to the emergency, such as the location of the vehicle (determined by the GPS satellite location system), vehicle model, identification number and color are generated.

A voice connection between the Response Center and the occupants of the vehicle will be established automatically soon after the emergency call has been initiated. The Response Center will attempt to determine more precisely the nature of the emergency provided they can speak to an occupant of the vehicle.

The Tele Aid system is available if:

- it has been activated and is operational. Activation requires a subscription for monitoring services, connection and cellular air time
- the relevant cellular phone network and GPS signals are available and pass the information on to the Response Center

i *Location of the vehicle on a map is only possible if the vehicle is able to receive signals from the GPS satellite network and pass the information on to the Response Center.*

Warning!

If the indicator lamp in the SOS button is flashing continuously and there was no voice connection to the Response Center established, then the Tele Aid system could not initiate an emergency call (e.g. the relevant cellular phone network is not available). The message *Call Failed* appears in the multifunction display for approximately 10 seconds.

Should this occur, assistance must be summoned by other means.

Initiating an emergency call manually

- ① Cover
- ② SOS button

- ▶ Briefly press on cover ①.
The cover will open.
- ▶ Press SOS button ② briefly.
The indicator lamp in SOS button ② will flash until the emergency call is concluded.

- ▶ Wait for a voice connection to the Response Center.
- ▶ Close cover ① after the emergency call is concluded.

Warning!

If you feel at any way in jeopardy when in the vehicle (e.g. smoke or fire in the vehicle, vehicle in a dangerous road location), please do not wait for voice contact after you have pressed the emergency button. Carefully leave the vehicle and move to a safe location. The Response Center will automatically contact local emergency officials with the vehicle's approximate location if they receive an automatic SOS signal and cannot make voice contact with the vehicle occupants.

Useful features

Roadside Assistance button

The Roadside Assistance button  is located below the center armrest cover.

- ▶ Press and hold the  button (for longer than 2 seconds).

A call to a Mercedes-Benz Roadside Assistance dispatcher will be initiated. The  button will flash while the call is in progress. The message **Connecting Call** will appear in the multifunction display and the audio system is muted.

When the connection is established, the message **Call Connected** appears in the multifunction display. The Tele Aid system will transmit data generating the vehicle identification number, model, color and location (subject to availability of cellular and GPS signals).



A voice connection between the Roadside Assistance dispatcher and the occupants of the vehicle will be established.

- ▶ Describe the nature of the need for assistance.

The Mercedes-Benz Roadside Assistance dispatcher will either dispatch a qualified Mercedes-Benz technician or arrange to tow your vehicle to the nearest authorized Mercedes-Benz Center. For services such as labor and/or towing, charges may apply. Refer to the Roadside Assistance manual for more information.

The following is only available in the USA:

- Sign and Drive services: Services such as jump start, a few gallons of fuel or the replacement of a flat tire with the vehicle spare tire are obtainable.

 *The indicator lamp on the Roadside Assistance button  remains illuminated in red for approximately 10 seconds during the system self-check after switching on the ignition (together with the SOS button and the Information button .*

See system self-check (▷ page 295) when the indicator lamp does not come on in red or stays on longer than approximately 10 seconds.

*If the indicator lamp on the Roadside Assistance button  is flashing continuously and there was no voice connection to the Response Center established, then the Tele Aid system could not initiate a Roadside Assistance call (e.g. the relevant cellular phone network is not available). The message **Call Failed** appears in the multifunction display.*

Roadside Assistance calls can be terminated using the  button on the multifunction steering wheel or the respective button for ending a telephone call on the audio system or the COMAND head unit.*

Information button 

The Information button  is located below the center armrest cover.

- ▶ Press and hold the  button (for longer than 2 seconds).



A call to the Customer Assistance Center will be initiated. The  button will flash while the call is in progress. The message **Connecting Call** will appear in the multifunction display and the audio system is muted.

When the connection is established, the message **Call Connected** appears in the multifunction display. The Tele Aid system will transmit data generating the vehicle identification number, model, color and location (subject to availability of cellular and GPS signals).

A voice connection between the Customer Assistance Center representative and the occupants of the vehicle will be established. Information regarding the operation of your vehicle, the nearest

Mercedes-Benz Center or Mercedes-Benz USA products and services is available to you.

For more details concerning the Tele Aid system, please visit www.mbusa.com and use your ID and password (sent to you separately) to learn more (USA only).

 *The indicator lamp on the Information button  remains illuminated in red for approximately 10 seconds during the system self-check after switching on the ignition (together with the SOS button and the Roadside Assistance button ).*

See System self-check (▷ page 295) when the indicator lamp does not come on in red or stays on longer than approximately 10 seconds.

*If the indicator lamp on the Information button  is flashing continuously and there was no voice connection to the Response Center established, then the Tele Aid system could not initiate an Information call (e.g. the relevant cellular phone network is not available). The message **Call Failed** appears in the multifunction display.*

Information calls can be terminated using the  button on the multifunction steering wheel or the respective button for ending a telephone call on the audio system or the COMAND head unit.*

 *If the indicator lamps do not start flashing after pressing one of the buttons or remain illuminated (in red) at any time, the Tele Aid system has detected a malfunction or the service is not currently active, and may not initiate a call. Visit an Mercedes-Benz Center and have the system checked or contact the Response Center at 1-800-756-9018 (in the USA) or 1-888-923-8367 (in Canada) as soon as possible.*

Useful features

Call priority

If other service calls such as a Roadside Assistance call or Information call are active, an Emergency call is still possible. In this case, the Emergency call will take priority and override all other active calls.

i The indicator lamp in the respective button flashes until the call is concluded. Calls can only be terminated by a Response Center or Customer Assistance Center representative except Roadside Assistance and Information calls, which can also be terminated by pressing button  on the multifunction steering wheel or the respective button for ending a telephone call on the audio system or the COMAND* head unit.

! If the indicator lamp continues to flash or the system does not reset, contact the Response Center at 1-800-756-9018 (in the USA), or 1-888-923-8367 (in Canada), or Mercedes-Benz Customer Assistance at 1-800-FOR-MERCEDES (1-800-367-6372) in the USA, or Customer Service at 1-800-387-0100 in Canada.

i When a Tele Aid call has been initiated, the audio system or the COMAND* system audio is muted and the selected mode (radio or CD) pauses. The optional cellular phone (if installed) switches off. If you must use this phone, the vehicle must be parked. Disconnect the coiled cord and place the call. The COMAND* navigation system (if engaged) will continue to run. The display in the instrument cluster is available for use, and spoken commands are only available by pressing the RPT button on the COMAND* head unit. A pop-up window will appear in the COMAND* display to indicate that a Tele Aid call is in progress.

Remote door unlock

In case you have locked your vehicle unintentionally (e.g. SmartKey inside vehicle), and the reserve SmartKey is not handy:

▶ Contact the Mercedes-Benz Response Center at 1-800-756-9018 (in the USA) or 1-888-923-8367 (in Canada).

You will be asked to provide your password which you provided when you completed the subscriber agreement.

▶ Then return to your vehicle and pull the trunk recessed handle for a minimum of 20 seconds until the SOS button is flashing.

The message **Connecting Call** appears in the multifunction display.

As an alternative, you may unlock the vehicle via Internet using the ID and password sent to you shortly after the completion of your acquaintance call.

The Response Center will then unlock your vehicle with the remote door unlocking feature.

i The remote door unlock feature is available if the relevant cellular phone network is available.

The SOS button will flash and the message Connecting Call will appear in the multifunction display to indicate receipt of the door unlock command.

Once the vehicle is unlocked, a Response Center specialist will attempt to establish voice contact with the vehicle occupants.

If the trunk recessed handle was pulled for more than 20 seconds before door unlock authorization was received by the Response Center, you must wait 15 minutes before pulling the trunk recessed handle again.

Stolen Vehicle Recovery services

In the event your vehicle was stolen:

- ▶ Report the incident to the police.
The police will issue a numbered incident report.
- ▶ Pass this number on to the Mercedes-Benz Response Center along with your password issued to you when you subscribed to the service.

The Response Center will then attempt to covertly contact the vehicle's Tele Aid system. Once the vehicle is located, the Response Center will contact the local law enforcement and you. The vehicle's location will only be provided to law enforcement.

If you have any questions, please call the Response Center at 1-800-756-9018 (in the USA) or 1-888-923-8367 (in Canada).

i When the anti-theft alarm stays on for more than 30 seconds, a call is initiated automatically to the Response Center, see "Anti-theft alarm system" (▷ page 97).

Garage door opener*

The integrated remote control is capable of operating up to three separately controlled devices. It provides a convenient way to replace up to three hand-held remote controls used to operate devices such as garage door openers, gate openers, or other devices compatible with HomeLink® or some other systems.

Before the integrated remote control can be used, it must be programmed to the garage door opener, gate operator or other device you wish to operate. See the following instructions for programming information.

Useful features

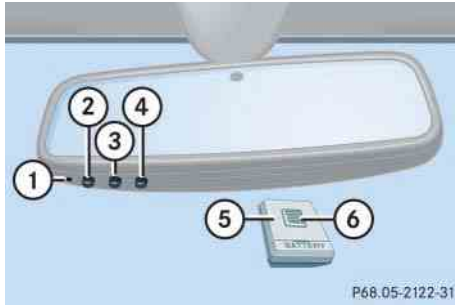

Interior rear view mirror with integrated remote control

- ① Indicator lamp
- ② ③ ④ Signal transmitter button

Needed for programming (not part of vehicle equipment):

- ⑤ Hand-held remote control of garage door opener, gate operator or other device
- ⑥ Hand-held remote control button

Warning!



Before programming the integrated remote control to a garage door opener or gate operator, make sure people and objects are out of the way of the device to prevent potential harm or damage. When programming a garage door opener, the door moves up or down. When programming a gate operator, the gate opens or closes.

Do not use the integrated remote control with any garage door opener that lacks safety stop and reverse features as required by U.S. federal safety standards (this includes any garage door opener model manufactured before April 1, 1982). A garage door that cannot detect an object – signaling the door to stop and reverse – does not meet current U.S. federal safety standards.

When programming a garage door opener, park outside the garage.

Do not run the engine while programming the integrated remote control. Inhalation of exhaust gas is hazardous to your health. All exhaust gas contains carbon monoxide (CO), and inhaling it can cause unconsciousness and possible death.

Programming the integrated remote control

Step 1:

- ▶ Switch on the ignition (▷ page 40).

Step 2:

- ▶ If you have previously programmed a signal transmitter button and wish to retain its programming, proceed to step 3.

If you are programming the integrated remote control for the first time, press and hold the two outer signal transmitter buttons ② and ④ and release them only when indicator lamp ①

begins to flash after approximately 20 seconds (do not hold the button for longer than 30 seconds). This procedure erases any previous settings for all three channels and initializes the memory.

If you later wish to program a second and/or third hand-held transmitter to the remaining two signal transmitter buttons, do not repeat this step and begin directly with step 3.

Step 3:

- ▶ Hold the end of hand-held remote control ⑤ of the device you wish to train approximately 2 to 5 inches (5 to 12 cm) away from the signal transmitter button (②, ③ or ④) to be programmed, while keeping indicator lamp ① in view.

Step 4:

- ▶ Using both hands, simultaneously press hand-held remote control button ⑥ and the desired signal trans-

mitter button (②, ③ or ④). Do not release the buttons until step 5 is completed.

Indicator lamp ① will flash, first slowly and then rapidly.

i Indicator lamp ① flashes immediately the first time the signal transmitter button is programmed. If this button has already been programmed, the indicator lamp will only start flashing after 20 seconds.

Step 5:

- ▶ After indicator lamp ① changes from a slow to a rapidly flashing light, release the hand-held remote control button and the signal transmitter button.

Step 6:

- ▶ Press and hold the just-trained signal transmitter button (②, ③ or ④) and observe indicator lamp ①.

If indicator lamp ① stays on constantly, programming is complete and your device should activate when the respective signal transmitter button (②, ③ or ④) is pressed and released.

i If indicator lamp ① flashes rapidly for about 2 seconds and then turns to a constant light, continue with programming steps 8 through 12 as your garage door opener may be equipped with the “rolling code” feature.

Step 7:

- ▶ To program the remaining two signal transmitter buttons, repeat the steps above starting with step 3.

Useful features

Rolling code programming

To train a garage door opener (or other rolling code devices) with the rolling code feature, follow these instructions after completing the “Programming” portion (steps 1 through 6) of this text. (A second person may make the following training procedures quicker and easier.)

Step 8:

- ▶ Locate “training” button on the garage door opener motor head unit.

Exact location and color of the button may vary by garage door opener brand. Depending on manufacturer, the “training” button may also be referred to as “learn” or “smart” button. If there is difficulty locating the transmitting button, refer to the garage door opener Operator’s Manual.

Step 9:

- ▶ Press the “training” button on the garage door opener motor head unit.

The “training light” is activated.

You have 30 seconds to initiate the following step.

Step 10:

- ▶ Return to the vehicle and firmly press, hold for 2 seconds and release the programmed signal transmitter button (②, ③ or ④).

Step 11:

- ▶ Press, hold for 2 seconds and release same signal transmitter button a second time to complete the training process.

i *Some garage door openers (or other rolling code equipped devices) may require you to press, hold for 2 seconds and release the same signal transmitter button a third time to complete the training process.*

Step 12:

- ▶ Confirm the garage door operation by pressing the programmed signal transmitter button (②, ③ or ④).

Step 13:

- ▶ To program the remaining two signal transmitter buttons, repeat the steps above starting with step 3.

Gate operator/Canadian programming

Canadian radio-frequency laws require transmitter signals to “time-out” (or quit) after several seconds of transmission which may not be long enough for the integrated signal transmitter to pick up the signal during programming. Similar to this Canadian law, some U.S. gate operators are designed to “time-out” in the same manner.

If you live in Canada or if you are having difficulties programming a gate operator (regardless of where you live) by using the programming procedures, replace step 4 with the following:

Step 4:

- ▶ Press and hold the signal transmitter button (②, ③ or ④). Do not release this button until it has been successfully trained.
- ▶ While still holding down the signal transmitter button (②, ③ or ④), “cycle” your hand-held remote control button ⑥ as follows: Press and hold button ⑥ for 2 seconds, then release it for 2 seconds, and again press and hold it for 2 seconds. Repeat this sequence on the hand-held remote control until the frequency signal has been learned. Upon successful training, indicator lamp ① will flash slowly and then rapidly after several seconds.
- ▶ Proceed with programming step 5 and step 6 to complete.

i Upon completion of programming the integrated remote control, make sure you retain the hand-held remote control that came with the garage door opener, gate operator or other device. You may need it for use in other vehicles, for future programming of an integrated remote control, or simply for continued use as a hand-held remote control to operate the respective device in other situations.

Reprogramming a single signal transmitter button

To program a device using a signal transmitter button previously trained, follow these steps:

- ▶ Switch on the ignition (▷ page 40).
- ▶ Press and hold the desired signal transmitter button (②, ③ or ④). Do not release the button.
- ▶ Indicator lamp ① will begin to flash after 20 seconds. Without releasing the signal transmitter button, proceed with programming starting with step 3.

Operation of integrated remote control

- ▶ Switch on the ignition (▷ page 40).
- ▶ Select and press the appropriate integrated signal transmitter button (②, ③ or ④) to activate the remote controlled device.

The integrated remote control transmitter continues to send the signal as long as the button is pressed – up to 20 seconds.

Erasing the integrated remote control memory

- ▶ Switch on the ignition (▷ page 40).
- ▶ Simultaneously press and hold outer signal transmitter buttons ② and ④, for approximately 20 seconds, until indicator lamp ① flashes rapidly. Do not hold for longer than 30 seconds.

The codes of all three channels are erased.

i If you sell your vehicle, erase the codes of all three channels.

Useful features

Programming tips

If you are having difficulty programming the integrated remote control, here are some helpful tips:

- Check the frequency of hand-held remote control ⑤ (typically located on the reverse side of the remote). The integrated remote control is compatible with radio-frequency devices operating between 280-390 MHz.
- Put a new battery in hand-held remote control ⑤. This will increase the likelihood of the hand-held remote control sending a faster and more accurate signal to the integrated remote control.
- While performing step 3, hold hand-held remote control ⑤ at different lengths and angles from the signal transmitter button (②, ③ or ④) you are programming. Attempt varying angles at the distance of 2 to 5 in (5 to 12 cm) away or the same angle at varying distances.

- If another hand-held remote control is available for the same device, try the programming steps again using that other hand-held remote control. Make sure new batteries are in the hand-held remote control before beginning the procedure.
- Straighten the antenna wire from the garage door opener assembly. This may help improve transmitting and/or receiving signals.

i *Certain types of garage door openers are incompatible with the integrated remote control. If you should experience further difficulties with programming the integrated remote control, contact an authorized Mercedes-Benz Center, or call Mercedes-Benz Customer Assistance Center (in the USA only) at 1-800-FOR-MERCEdes, or Customer Service (in Canada) at 1-800-387-0100.*

i *USA only:*

This device complies with Part 15 of the FCC Rules. Operation is subject to the following two conditions:

- (1) This device may not cause harmful interference, and*
- (2) this device must accept any interference received, including interference that may cause undesired operation.*

Any unauthorized modification to this device could void the user's authority to operate the equipment.

i *Canada only:*

This device complies with RSS-210 of Industry Canada. Operation is subject to the following two conditions:

- (1) This device may not cause interference, and*
- (2) this device must accept any interference received, including interference that may cause undesired operation of the device.*

Any unauthorized modification to this device could void the user's authority to operate the equipment.

The first 1 000 miles (1 500 km)

Driving instructions

At the gas station

Engine compartment

Tires and wheels

Winter driving

Maintenance

Vehicle care



The first 1 000 miles (1 500 km)

In the “Operation” section you will find detailed information on operating, maintaining and caring for your vehicle.

The more cautiously you treat your vehicle during the break-in period, the more satisfied you will be with its performance later on.

- Drive your vehicle during the first 1 000 miles (1 500 km) at varying but moderate vehicle and engine speeds.
- During this period, avoid heavy loads (full throttle driving) and excessive engine speeds (no more than $\frac{2}{3}$ of maximum rpm in each gear).
- Shift gears in a timely manner.
- Avoid accelerating by kickdown.
- Do not attempt to slow the vehicle down by shifting to a lower gear using the gear selector lever.
- Select positions **3**, **2** or **1** only when driving at moderate speeds (for hill driving).
- Select mode **C** as the preferred shift program (▷ page 178) for the first 1 000 miles (1 500 km).

After 1 000 miles (1 500 km), you may gradually increase vehicle and engine speeds to the permissible maximum.

Additional instructions for AMG vehicles:

- *During the first 1 000 miles (1 500 km), do not exceed a speed of 85 mph (140 km/h).*
- *During this period, avoid engine speeds above 4500 rpm in each gear.*
- *Shift gears at the correct time.*

All of the above instructions, as may apply to your vehicle type, also apply when driving the first 1 000 miles (1 500 km) after the engine or the rear differential has been replaced.

 *Always obey applicable speed limits.*

▼ Driving instructions

Drive sensibly – save fuel

Fuel consumption, to a great extent, depends on driving habits and operating conditions.

To save fuel you should:

- Keep tires at the recommended tire inflation pressures.
- Remove unnecessary loads.
- Allow engine to warm up under low load use.
- Avoid frequent acceleration and deceleration.
- Have all maintenance work performed at the intervals specified in the Maintenance Booklet and as required by the Maintenance System. Contact an authorized Mercedes-Benz Center.
- CLK coupe: Remove roof rack when not in use.

Fuel consumption is also increased by driving in cold weather, in stop-and-go traffic, on short trips and in hilly area.

Drinking and driving

Warning!



Drinking and driving and/or taking drugs and driving are very dangerous combinations. Even a small amount of alcohol or drugs can affect your reflexes, perceptions and judgment.

The possibility of a serious or even fatal accident are greatly increased when you drink or take drugs and drive.

Do not drink or take drugs and drive or allow anyone to drive who has been drinking or taking drugs.

Pedals

Warning!



Make sure absolutely no objects are obstructing the pedals' range of movement. Keep the driver's footwell clear of all obstacles. If there are any floor mats or carpets in the footwell, make sure the pedals still have sufficient clearance.

During sudden driving or braking maneuvers, the objects could get caught between or beneath the pedals. You could then no longer brake or accelerate. This could lead to accidents and injury.

Driving instructions

Power assistance

Warning!



With the engine not running, there is no power assistance for the brake and steering systems. In this case, it is important to keep in mind that a considerably higher degree of effort is necessary to brake and steer the vehicle.

Brakes

Warning!



After driving in heavy rain for some time without applying the brakes or through water deep enough to wet brake components, the first braking action may be somewhat reduced and increased pedal pressure may be necessary to obtain expected braking effect. Maintain a safe distance from vehicles in front.

Resting your foot on the brake pedal will cause excessive and premature wear of the brake pads.

It can also result in the brakes overheating, thereby significantly reducing their effectiveness. It may not be possible to stop the vehicle in sufficient time to avoid an accident.

! *Because the ESP® operates automatically, the engine must be shut off (SmartKey in starter switch position 0 or 1 or KEYLESS-GO start/stop button* in position 0 or 1) when*

- *the parking brake is being tested on a brake test dynamometer*
- *the vehicle is being towed with the front axle raised*

Active braking action through the ESP® may otherwise seriously damage the brake system.

To help prevent brake disk corrosion after driving on wet road surfaces (particularly salted roads), it is advisable to brake the vehicle with considerable force prior to parking. The heat generated serves to dry the brakes.

If your brake system is normally only subject to moderate loads, you should occasionally test the effectiveness of the brakes by applying above-normal braking pressure at higher speeds. This will also enhance the grip of the brake pads.

Warning!



Make sure not to endanger any other road users when carrying out these braking maneuvers.

Refer to the description of the Brake Assist System (BAS) (▷ page 92).

Brake pad wear or a leak in the system may be the reason for low brake fluid level in the reservoir.

The brake fluid level in the reservoir may be too low if the brake warning lamp in the instrument cluster comes on and an acoustic warning sounds although the parking brake is released (▷ page 380).

Observe additional messages in the multi-function display that may appear (▷ page 404).

Have the brake system inspected immediately. Contact an authorized Mercedes-Benz Center.

All checks and service work on the brake system should be carried out by qualified technicians only. Contact an authorized Mercedes-Benz Center.

Only install brake pads and brake fluid recommended by Mercedes-Benz.

Warning!



If other than recommended brake pads are installed, or other than recommended brake fluid is used, the braking properties of the vehicle can be degraded to an extent that safe braking is substantially impaired. This could result in an accident.

! *When driving down long and steep grades, relieve the load on the brakes by shifting into a lower gear to use the engine's braking power. This helps prevent overheating of the brakes and reduces brake pad wear.*

After hard braking, it is advisable to drive on for some time, rather than immediately park, so that the air stream can cool down the brakes faster.

High-performance brake system (CLK 63 AMG only)

The high-performance brake system is designed to operate under the extremely high operating demands required to accommodate the performance capabilities of the vehicle. The brakes may produce a squeaking-type noise depending on the

- vehicle speed
- brake force applied
- ambient conditions, e.g. temperature and humidity

As with any brake system, the wear of individual brake system components such as brake pads or discs strongly depends on your driving style and the conditions under which you operate the vehicle. Thus, a driving style calling for high demand braking will cause your vehicle's brakes to wear more quickly.

Driving instructions

Warning!



New vehicle brake pads and discs, and replacement brake pads and discs may take several hundred miles of driving until they provide optimum braking efficiency. Until that time, you may need to use increased brake pedal pressure while braking. Please be aware of this and adjust your driving and braking accordingly during this break-in period.

Excessive high demand braking will cause correspondingly high brake wear. Please be attentive to the brake warning lamp in the instrument cluster and brake condition messages in the multifunction display. Especially for high performance driving, it is important to maintain and have the brake system checked regularly.

Driving off

Apply the brakes to test them briefly after driving off. Perform this procedure only when the road is clear of other traffic.

Warm up the engine gradually. Do not place full load on the engine until the operating temperature has been reached.

! *When driving off on a slippery surface, do not allow a drive wheel to spin for an extended period with the ESP[®] switched off. Doing so may cause serious damage to the drivetrain which is not covered by the Mercedes-Benz Limited Warranty.*

! *Simultaneously depressing the accelerator pedal and applying the brakes reduces engine performance and causes premature brake wear and drivetrain wear.*

Parking

Warning!



Do not park this vehicle in areas where combustible materials such as grass, hay or leaves can come into contact with the hot exhaust system, as these materials could be ignited and cause a vehicle fire.

To reduce the risk of personal injury, or damage to the vehicle or the vehicle drivetrain, as a result of vehicle movement, always do the following before turning off the engine and leaving the vehicle:

- Keep right foot firmly on brake pedal.
- Firmly depress parking brake pedal.
- Move the gear selector lever to position **P**.
- Slowly release brake pedal.
- When parked on an incline, always turn the front wheels towards the road curb.

- Turn the SmartKey or the SmartKey with KEYLESS-GO* to starter switch position **0** and remove, or press KEYLESS-GO* start/stop button.
- Take the SmartKey or the SmartKey with KEYLESS-GO* with you and lock the vehicle when leaving.

Tires

Warning!



If you feel a sudden significant vibration or ride disturbance, or you suspect that possible damage to your vehicle has occurred, you should turn on the hazard warning flashers, carefully slow down, and drive with caution to an area which is a safe distance from the road.

Inspect the tires and the vehicle underbody for possible damage. If the vehicle or tires appear unsafe, have the vehicle towed to the nearest Mercedes-Benz Center or tire dealer for repairs.

Treadwear indicators (TWI) are required by law. These indicators are located in six places on the tread circumference and become visible at a tread depth of approximately $\frac{1}{16}$ in (1.6 mm), at which point the tire is considered worn and should be replaced.

The treadwear indicator appears as a solid band across the tread.

Warning!



Although the applicable federal motor vehicle safety laws consider a tire to be worn when the treadwear indicators (TWI) become visible at approximately $\frac{1}{16}$ in (1.6 mm), we recommend that you do not allow your tires to wear down to that level. As tread depth approaches $\frac{1}{8}$ in (3 mm), the adhesion properties on a wet road are sharply reduced.

Depending upon the weather and/or road surface (conditions), the tire traction varies widely.

Specified tire inflation pressures must be maintained. This applies particularly if the tires are subject to extreme operating conditions (e.g. high speeds, heavy loads, high ambient temperatures).

Driving instructions

Warning!



Do not drive with a flat tire. A flat tire affects the ability to steer or brake the vehicle. You may lose control of the vehicle. Continued driving with a flat tire or driving at high speed with a flat tire will cause excessive heat build-up and possibly a fire.

For more information, see “Tires and wheels” (▷ page 331).

Hydroplaning

Depending on the depth of the water layer on the road, hydroplaning may occur, even at low speeds and with new tires. Reduce vehicle speed, avoid track grooves in the road and apply brakes cautiously in the rain.

Tire traction

The safe speed on a wet, snow covered or icy road is always lower than on a dry road.

You should pay particular attention to the condition of the road whenever the outside temperatures are close to the freezing point.

Warning!



If ice has formed on the road, tire traction will be substantially reduced. Under such weather conditions, drive, steer and brake with extreme caution.

Mercedes-Benz recommends winter tires (▷ page 362) with a minimum tread depth of approximately $\frac{1}{6}$ in (4 mm) on all four wheels for the winter season to ensure normal balanced handling characteristics. On packed snow, they can reduce your stopping distance compared to summer tires. Stopping distance, however, is still considerably greater than when the road is not covered with snow or ice. Exercise appropriate caution.

! *Avoid spinning of a drive wheel. This may cause serious damage to the drivetrain which is not covered by the Mercedes-Benz Limited Warranty.*

Tire speed rating

Regardless of the tire speed rating, local speed limits should be obeyed. Use prudent driving speeds appropriate to prevailing conditions.

Warning!



Even when permitted by law, never operate a vehicle at speeds greater than the maximum speed rating of the tires.

Exceeding the maximum speed for which tires are rated can lead to sudden tire failure, causing loss of vehicle control and possibly resulting in an accident and/or personal injury and possible death, for you and for others.

An electronic speed limiter prevents your vehicle from exceeding a speed of

- CLK 350, CLK 550:
130 mph (210 km/h)
- CLK 63 AMG:
155 mph (250 km/h)
- CLK 63 AMG with increased top speed*:
174 mph (280 km/h)

The factory equipped tires on your vehicle may have a tire speed rating above the maximum speed permitted by the electronic speed limiter.

Make sure your tires have the required tire speed rating as specified for your vehicle in the “Technical data” section (▷ page 482), for example when purchasing new tires.

For information on how to identify the tire speed rating on a tire’s sidewall, see “Tire size designation, load and speed rating” (▷ page 349).

If you are uncertain about the correct reading of the information given on a tire’s sidewall, any authorized Mercedes-Benz Center will be glad to assist you.

 For information on tire speed rating for winter tires, see “Winter tires” (▷ page 362).

For additional general information on tire speed markings on tire sidewall, see “Tire speed rating” (▷ page 351).

Driving instructions

Winter driving instructions

The most important rule for slippery or icy roads is to drive sensibly and to avoid abrupt acceleration, braking and steering maneuvers. Do not use the cruise control system under such conditions.

When the vehicle is in danger of skidding, move gear selector lever to position **N**. Try to keep the vehicle under control by corrective steering action.

i For information on driving with snow chains, see “Snow chains” (▷ page 363).

Warning!



On slippery road surfaces, never downshift in order to obtain braking action. This could result in drive wheel slip and reduced vehicle control. Your vehicle’s ABS will not prevent this type of control loss.

Road salts and chemicals can adversely affect braking efficiency. Increased pedal force may become necessary to produce the normal braking effect.

Depressing the brake pedal periodically when traveling at length on salt-strewn roads can bring road-salt-impaired braking efficiency back to normal.

If the vehicle is parked after being driven on salt-treated roads, the braking efficiency should be tested as soon as possible after driving is resumed.

Warning!



Make sure not to endanger any other road users when carrying out these braking maneuvers.

Warning!



If the vehicle becomes stuck in snow, make sure snow is kept clear of the exhaust pipe and from around the vehicle with the engine running. Otherwise, deadly carbon monoxide (CO) gases may enter vehicle interior resulting in unconsciousness and death.

To assure sufficient fresh air ventilation, open a window slightly on the side of the vehicle not facing the wind.

Warning!



The outside temperature indicator is not designed to serve as an ice-warning device and is therefore unsuitable for that purpose. Indicated temperatures just above the freezing point do not guarantee that the road surface is free of ice.

For more information, see “Winter driving” (▷ page 362).

Standing water

! Do not drive through flooded areas or water of unknown depth. Before driving through water, determine its depth. Never accelerate before driving into water. The bow wave could force water into the engine and auxiliary equipment, thus damaging them.

If you must drive through standing water, drive slowly to prevent water from entering the passenger compartment or the engine compartment. Water in these areas could cause damage to electrical components or wiring of the engine or transmission, or could result in water being ingested by the engine through the air intake, causing severe internal engine damage. Any such damage is not covered by the Mercedes-Benz Limited Warranty.

Passenger compartment

Warning!



Always fasten items being carried as securely as possible.

In an accident, during hard braking or sudden maneuvers, loose items will be thrown around inside the vehicle, and cause injury to vehicle occupants unless the items are securely fastened in the vehicle.

The trunk is the preferred place to carry objects.

Driving abroad

Abroad, there is an extensive Mercedes-Benz service network at your disposal. If you plan to drive into areas which are not listed in the index of your Mercedes-Benz Center directory, you should request pertinent information from an authorized Mercedes-Benz Center.

Control and operation of radio transmitters

COMAND*, radio and telephone*

Warning!



Please do not forget that your primary responsibility is to drive the vehicle safely. Only operate the COMAND (Cockpit Management and Data System), radio or telephone¹ if road, weather and traffic conditions permit.

Bear in mind that at a speed of just 30 mph (approximately 50 km/h), your vehicle is covering a distance of 44 feet (approximately 14 m) every second.

¹ Observe all legal requirements.

Driving instructions

Telephones* and two-way radios

Warning!



Never operate radio transmitters equipped with a built-in or attached antenna (i.e. without being connected to an external antenna) from inside the vehicle while the engine is running. Doing so could lead to a malfunction of the vehicle's electronic system, possibly resulting in an accident and/or serious personal injury.

Radio transmitters, such as a mobile phone or a citizens band unit should only be used inside the vehicle if they are connected to an antenna that is installed on the outside of the vehicle.

Refer to the radio transmitter operation instructions regarding use of an external antenna.

Catalytic converter

Your Mercedes-Benz is equipped with monolithic-type catalytic converters, an important element in conjunction with the oxygen sensors to achieve substantial control of the pollutants in the exhaust emissions. Keep your vehicle in proper operating condition by following our recommended maintenance instructions as outlined in your Maintenance Booklet.

! *To prevent damage to the catalytic converters, only use premium unleaded gasoline in this vehicle.*

Any noticeable irregularities in engine operation should be repaired promptly. Otherwise, excessive unburned fuel may reach the catalytic converter, causing it to overheat and potentially start a fire.

Warning!



As with any vehicle, do not idle, park or operate this vehicle in areas where combustible materials such as grass, hay, or leaves can come into contact with the hot exhaust system, as these materials could be ignited and cause a vehicle fire.

Emission control

Certain systems of the engine serve to keep the toxic components of the exhaust gases within permissible limits required by law.

These systems, of course, will function properly only when maintained strictly according to factory specifications. Any adjustments to the engine should therefore be carried out only by qualified Mercedes-Benz Center authorized technicians.

Engine adjustments should not be altered in any way. Moreover, the specified service jobs must be carried out regularly according to Mercedes-Benz servicing requirements. For details refer to the Maintenance Booklet.

Warning!

Inhalation of exhaust gas is hazardous to your health. All exhaust gas contains carbon monoxide (CO), and inhaling it can cause unconsciousness and lead to death.

Do not run the engine in confined areas (such as a garage) which are not properly ventilated. If you think that exhaust gas fumes are entering the vehicle while driving, have the cause determined and corrected immediately. If you must drive under these conditions, drive with at least one window fully open at all times.

Coolant temperature

During severe operating conditions and stop-and-go city traffic, the coolant temperature may rise close to approximately 248°F (120°C).

The engine should not be operated with the coolant temperature over 248°F (120°C). Doing so may cause serious engine damage which is not covered by the Mercedes-Benz Limited Warranty.

Warning!

- Driving when your engine is overheated can cause some fluids, which may have leaked into the engine compartment, to catch fire. You could be seriously burned.
- Steam from an overheated engine can cause serious burns which can occur just by opening the hood. Stay away from the engine if you see or hear steam coming from it.

Turn off the engine, get out of the vehicle and do not stand near the vehicle until the engine has cooled down.

At the gas station

Refueling

Warning!



Gasoline is highly flammable and poisonous. It burns violently and can cause serious personal injury.

Never allow sparks, flame or smoking materials near gasoline!

Turn off the engine before refueling.

Whenever you are around gasoline, avoid inhaling fumes and skin or clothing contact, extinguish all smoking materials.

Direct skin contact with fuels and the inhalation of fuel vapors can damage to your health.

The fuel filler flap is located on the right-hand side of the vehicle towards the rear. Locking/unlocking the vehicle with the SmartKey or the SmartKey with KEYLESS-GO* automatically locks/unlocks the fuel filler flap.

i In cases where the central locking system is not releasing the fuel filler flap, or the opening mechanism is clamping, notify Roadside Assistance or an authorized Mercedes-Benz Center.



- ① To open the fuel filler flap
- ② To insert the fuel filler cap

- ▶ Turn off the engine
- ▶ Vehicles with SmartKey: Remove the SmartKey from the starter switch.

Vehicles with KEYLESS-GO*: Open the driver's door (with driver's door open, starter switch is now in position **0**, same as with SmartKey removed from starter switch). The driver's door then can be closed again.

- ▶ Open the fuel filler flap by pushing at the point indicated by arrow ①.
The fuel filler flap springs open.
- ▶ Turn the fuel cap counterclockwise and hold on to it until possible pressure is released.

- ▶ Take off the fuel cap and set it in the direction of arrow ② in the recess on the fuel filler flap.

To prevent fuel vapors from escaping into open air, fully insert the filler nozzle unit.

- ▶ Only fill your tank until the filler nozzle unit cuts out – **do not top off or overfill.**

Warning!



Overfilling of the fuel tank may create pressure in the system which could cause a gas discharge. This could cause the gas to spray back out when removing the fuel pump nozzle, which could cause personal injury.

- ▶ Replace the fuel cap by turning it clockwise until it audibly engages.



i Make sure to close the fuel filler flap before locking your vehicle as the flap locking pin prevents closing after you have locked the vehicle.

- ▶ Close the fuel filler flap.

i Only use premium unleaded gasoline with a minimum Posted Octane Rating of 91 (average of 96 RON/86 MON).

Information on gasoline quality can normally be found on the fuel pump. Please contact gas station personnel in case labels on the pump cannot be found.

For more information on gasoline, see “Premium unleaded gasoline” (▷ page 492), or the Factory Approved Service Products pamphlet (USA only), or contact an authorized Mercedes-Benz Center.

i Leaving the engine running and the fuel cap open can cause the  malfunction indicator lamp (USA only) or the  malfunction indicator lamp (Canada only) to illuminate.

More information can be found in the “Practical hints” section (▷ page 381).

At the gas station

Check regularly and before a long trip

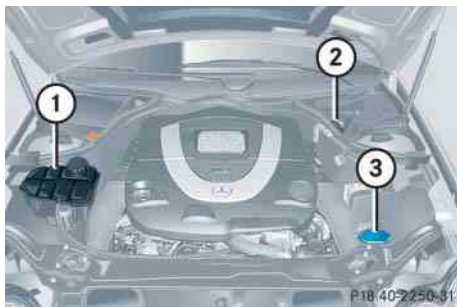

Engine compartment (CLK 550, example)

- ① Coolant level
- ② Brake fluid (fuse box cover removed)
- ③ Windshield washer and headlamp cleaning system*

i Opening the hood, see (▷ page 323).

Coolant

For normal replenishing, use water (potable water quality). For more information, see “Coolant” (▷ page 328) and see “Fuels, coolants, lubricants, etc.” (▷ page 489).

Brake fluid

Removing fuse box cover, see (▷ page 473).

! *If you find that the brake fluid in the brake fluid reservoir has fallen to the minimum mark or below, have the brake system checked for brake pad thickness and leaks immediately. Notify an authorized Mercedes-Benz Center immediately. Do not add brake fluid as this will not solve the problem. For more information, see also “Practical hints” (▷ page 380).*

Windshield washer and headlamp cleaning system*

For more information on filling up the washer reservoir, see “Windshield washer system and headlamp cleaning system*” (▷ page 330).

Engine oil level

For more information on engine oil, see “Engine oil” (▷ page 325).

Vehicle lighting

Check function and cleanliness. For more information on replacing light bulbs, see “Replacing bulbs” (▷ page 443).

For more information, see “Exterior lamp switch” (▷ page 55).

Tire inflation pressure

For more information, see “Checking tire inflation pressure” (▷ page 341).

▼ Engine compartment

Hood

Warning!



Do not pull the release lever while the vehicle is in motion. Otherwise the hood could be forced open by passing air flow.

This could cause the hood to come loose and injure you and/or others.

Opening

Warning!



If you see flames or smoke coming from the engine compartment, or if the coolant temperature indicator indicates that the engine is overheated, do not open the hood. Move away from vehicle and do not open the hood until the engine has cooled. If necessary, call the fire department.

Warning!



You could be injured when the hood is open - even when the engine is turned off.

Parts of the engine can become very hot. To prevent burns, let the engine cool off completely before touching any components on the vehicle. Comply with all relevant safety precautions.

Warning!



To help prevent personal injury, stay clear of moving parts when the hood is open and the engine is running.

The radiator fan may continue to run for approximately 30 seconds or even restart after the engine has been turned off. Stay clear of fan blades.

Warning!



The engine is equipped with a transistorized ignition system. Because of the high voltage it is dangerous to touch any components (ignition coils, spark plug sockets, diagnostic socket) of the ignition system

- with the engine running
- while starting the engine
- if the ignition is “on” and the engine is turned manually.

Engine compartment

The hood lock release lever is located to the left of the steering wheel under the dashboard.

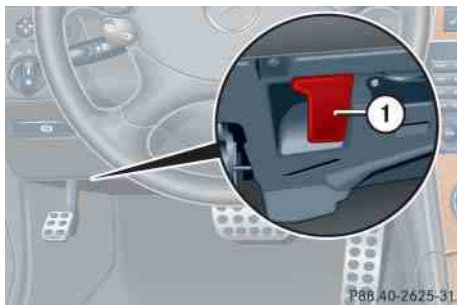

- ① Hood lock release lever
- ▶ Pull lever ① downwards.
The hood is unlocked.

! To avoid damage to the windshield wipers or hood, never open the hood if the wiper arms are folded forward away from the windshield.

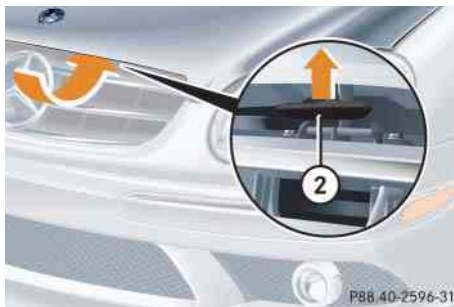

- ② Lever for opening the hood
- ▶ Push lever ② under the hood upwards.
- ▶ Pull up on the hood and then release it.
The hood will be automatically held open at shoulder height by gas-filled struts.

Closing

Warning!



When closing the hood, use extreme caution not to catch hands or fingers.

Be careful that you do not close the hood on anyone.

Make sure the hood is securely engaged before driving off. Do not continue driving if the hood can no longer engage after an accident, for example. The hood could otherwise come loose while the vehicle is in motion and injure you and/or others.

- ▶ Let the hood drop from a height of approximately 1 ft (30 cm).
The hood will lock audibly.
- ▶ Check to make sure the hood is fully closed.

If you can raise the hood at a point above the headlamps, then it is not properly closed. Open it again and let it drop with somewhat greater force.

Engine oil

The amount of oil your engine needs will depend on a number of factors, including driving style. Higher oil consumption can occur when

- the vehicle is new
- the vehicle is driven frequently at higher engine speeds

Engine oil consumption checks should only be made after the vehicle break-in period.

! *Do not use any special lubricant additives, as these may damage the drive assemblies. Using special additives not approved by Mercedes-Benz may cause damage not covered by the Mercedes-Benz Limited Warranty. More information on this subject is available at any Mercedes-Benz Center.*

Checking engine oil level

When checking the oil level

- the vehicle must be parked on level ground.
- with the engine at operating temperature yet, the vehicle must have been stationary for at least 5 minutes with the engine turned off.
- with the engine not at operating temperature, the vehicle must have been stationary for at least 30 minutes with the engine turned off.

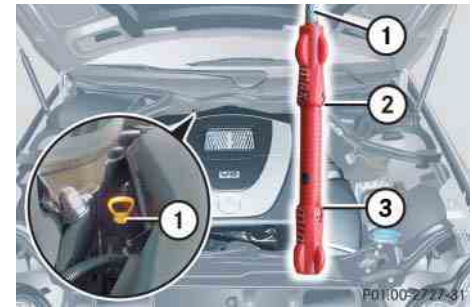

CLK 350 / CLK 550

- ① Oil dipstick
- ② Upper (max) mark
- ③ Lower (min) mark



Engine compartment



CLK 63 AMG

- ① Oil dipstick
- ② Upper (max) mark
- ③ Lower (min) mark

To check the engine oil level with the oil dipstick, do the following:

- ▶ Open the hood (▷ page 323).
- ▶ Pull out oil dipstick ①.
- ▶ Wipe oil dipstick ① clean.
- ▶ Fully insert oil dipstick ① into the dipstick guide tube.
- ▶ Pull out oil dipstick ① again after approximately 3 seconds to obtain accurate reading.

The oil level is correct when it is between the lower (min) mark ③ and upper (max) mark ② of oil dipstick ①.

i CLK 350:

The filling quantity between the upper and lower marks on the oil dipstick is approximately 2.1 US qt. (2.0 l).

CLK 550 / CLK 63 AMG:

The filling quantity between the upper and lower marks on the oil dipstick is approximately 1.6 US qt. (1.5 l).

- ▶ If necessary, add engine oil.

For adding engine oil, see “Adding engine oil” (▷ page 327).

For more information on engine oil, see “Fuels, coolants, lubricants, etc.” (▷ page 489).

For more information on messages in the multifunction display concerning engine oil, see the “Practical hints” section (▷ page 409).

Adding engine oil

! Only use approved engine oils and oil filters required for vehicles with Maintenance System. For a listing of approved engine oils and oil filters, refer to the Factory Approved Service Products pamphlet (USA only) in your vehicle literature portfolio, or contact an authorized Mercedes-Benz Center.

Using engine oils and oil filters of specification other than those expressly required for the Maintenance System, or changing of oil and oil filter at change intervals longer than those called for by the Maintenance System will result in engine or emission control system damage not covered by the Mercedes-Benz Limited Warranty.



CLK 350 / CLK 550

① Filler cap



CLK 63 AMG

① Filler cap

- ▶ Unscrew filler cap ① from filler neck.
- ▶ Add engine oil as required. Be careful not to overfill with oil.

Be careful not to spill any oil when adding. Avoid environmental damage caused by oil entering the ground or water.

! Excess oil must be siphoned or drained off. It could cause damage to the engine and emission control system not covered by the Mercedes-Benz Limited Warranty.

- ▶ Screw filler cap ① back on filler neck.

More information on engine oil can be found in the “Technical data” section (▷ page 489) and (▷ page 491).

Transmission fluid level

The transmission fluid level does not need to be checked. If you notice transmission fluid loss or gear shifting malfunctions, have an authorized Mercedes-Benz Center check the automatic transmission.

Engine compartment

Coolant

The engine coolant is a mixture of water and anticorrosion/antifreeze.

When checking the coolant level,

- the vehicle must be parked on level ground
- the coolant temperature must be below 158°F (70°C)

Warning!



In order to avoid potentially serious burns:

- Use extreme caution when opening the hood if there are any signs of steam or coolant leaking from the cooling system, or if the coolant temperature indicator indicates that the coolant is overheated.
- Do not remove pressure cap on coolant reservoir if the coolant temperature is above 158°F (70°C). Allow the coolant to cool down before removing cap.

The coolant reservoir contains hot fluid and is under pressure.

- Using a rag, slowly open the cap approximately $\frac{1}{2}$ turn to relieve excess pressure. If opened immediately, scalding hot fluid and steam will be blown out under pressure.
- Do not spill antifreeze on hot engine parts. Antifreeze contains ethylene glycol which may burn if it comes into contact with hot engine parts.

The coolant expansion tank is located on the passenger side of the engine compartment.



- ① Coolant expansion tank
- ② Cap

- ▶ Using a rag, turn cap ② slowly approximately one half turn counter-clockwise to release any excess pressure.
- ▶ Continue turning the cap ② counter-clockwise and remove it.

The coolant level is correct if the level

- for cold coolant: reaches the marking (plastic bridge) inside the reservoir
 - for warm coolant: is approximately 0.6 in (1.5 cm) higher
- ▶ Add coolant as required.
 - ▶ Replace and tighten cap ②.

More information on coolant can be found in the “Technical data” section (▷ page 494).

Battery

Your vehicle's battery is located in the engine compartment on the right-hand side (> page 464).

The battery should always be sufficiently charged in order to achieve its rated service life. Refer to Maintenance Booklet for battery maintenance intervals.

If you use your vehicle mostly for short-distance trips, you will need to have the battery charge checked more frequently.

When replacing the battery, always use batteries approved by Mercedes-Benz.

If you do not intend to operate your vehicle for an extended period of time, consult an authorized Mercedes-Benz Center about steps you need to observe.

Warning!



Observe all safety instructions and precautions when handling automotive batteries.



Risk of explosion.



Fire, open flames and smoking are prohibited when handling batteries. Avoid creating sparks.



Battery acid is caustic. Do not allow it to come into contact with skin, eyes or clothing.

Wear suitable protective clothing, especially gloves, apron and faceguard.



Wear eye protection.

Rinse any acid spills immediately with clear water. Contact a physician if necessary.



Keep children away.



Follow the instructions in this Operator's Manual.

Batteries contain materials that can harm the environment if disposed of improperly. Recycling of batteries is the preferred method of disposal. Many states require sellers of batteries to accept old batteries for recycling.

Engine compartment

Windshield washer system and headlamp cleaning system*

The windshield washer reservoir is located in the engine compartment.

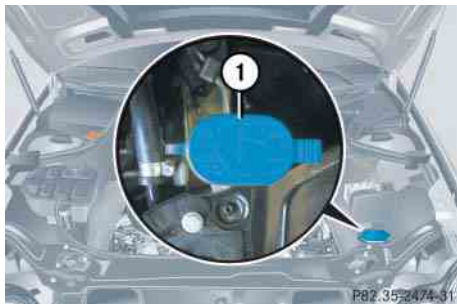

① Washer fluid reservoir cap

Fluid for the windshield washer system and the headlamp cleaning system* is supplied from the windshield washer reservoir. It has a capacity of:

- 3.2 US qt (3.0 l) in vehicles with windshield washer system
- 6.4 US qt (6.0 l) in vehicles with heated windshield washer system* and headlamp cleaning system*.

During all seasons, add MB Windshield Washer Concentrate “MB SummerFit” to water. Premix the windshield washer fluid in a suitable container.

Warning!



Washer solvent/antifreeze is highly flammable. Do not spill washer solvent/antifreeze on hot engine parts, because it may ignite and burn. You could be seriously burned.

- ▶ Refill the reservoir with MB Windshield Washer Concentrate “MB SummerFit” and water (or commercially available premixed windshield washer solvent / antifreeze, depending on ambient temperatures).

! *Always use washer solvent/antifreeze where temperatures may fall below the freezing point. Failure to do so could result in damage to the washer system/reservoir.*

! *Only use washer fluid which is suitable for plastic lenses. Improper washer fluid can damage the plastic lenses of the headlamps.*

For more information, see “Windshield washer system and headlamp cleaning system*” (▷ page 496).

▼ Tires and wheels

Contact an authorized Mercedes-Benz Center for information on tested and recommended rims and tires for summer and winter operation. They can also offer advice concerning tire service and purchase.

Warning!



Replace rims or tires with the same designation, manufacturer and type as shown on the original part. See an authorized Mercedes-Benz Center for further information. If incorrectly sized rims and tires are mounted:

- The wheel brakes or suspension components can be damaged.
- The operating clearance of the wheels and the tires may no longer be correct.

Warning!



Worn, old tires can cause accidents. If the tire tread is badly worn, or if the tires have sustained damage, replace them.

When replacing rims, only use genuine Mercedes-Benz wheel bolts specified for the particular rim type. Failure to do so can result in the bolts loosening and possibly an accident.

Retreaded tires are not tested or recommended by Mercedes-Benz, since previous damage cannot always be recognized on re-treads. The operating safety of the vehicle cannot be assured when such tires are used.

Important guidelines

- Only use sets of tires and rims of the same type and make.
- Tires must be of the correct size for the rim.
- Break in new tires for approximately 60 miles (100 km) at moderate speeds.
- Regularly check the tires and rims for damage. Dented or bent rims can cause tire inflation pressure loss and damage to the tire beads.
- If vehicle is heavily loaded, check tire inflation pressure and correct as required.
- Do not allow your tires to wear down too far. Adhesion properties on wet roads are sharply reduced at tread depths of less than $\frac{1}{8}$ in (3 mm).
- When replacing individual tires, you should mount new tires on the front wheels first (on vehicles with same-sized wheels all around).

Tires and wheels

Tire care and maintenance

Warning!



Regularly check the tires for damage. Damaged tires can cause tire inflation pressure loss. As a result, you could lose control of your vehicle.

Worn, old tires can cause accidents. If the tire tread is badly worn, or if the tires have sustained damage, replace them.

Regularly check your tire inflation pressure at least once a month. For more information on checking tire inflation pressure see “Recommended tire inflation pressure” (▷ page 339).

Tire inspection

Every time you check your tire inflation pressure, you should also inspect your tires for the following:

- excessive treadwear (▷ page 333)
- cord or fabric showing through the tire’s rubber
- bumps, bulges, cuts, cracks or splits in the tread or side of the tire

Replace the tire if you find any of the above conditions.

Make sure you also inspect the spare tire periodically for condition and inflation. Spare tires will age and become worn over time even if never used, and thus should be inspected and replaced when necessary.

Life of tire

The service life of a tire is dependent upon varying factors including but not limited to:

- Driving style
- Tire inflation pressure
- Distance driven

Warning!



Tires and spare tire should be replaced after 6 years, regardless of the remaining tread.

Tread depth

Do not allow your tires to wear down too far. Adhesion properties on wet roads are sharply reduced at tread depths of less than $\frac{1}{8}$ in (3 mm).

Treadwear indicators (TWI) are required by law. These indicators are located in six places on the tread circumference and become visible at a tread depth of approximately $\frac{1}{16}$ in (1.6 mm), at which point the tire is considered worn and should be replaced.

Recommended minimum tire tread depth:

- Summer tires $\frac{1}{8}$ in (3 mm)
- Winter tires $\frac{1}{6}$ in (4 mm)

Warning!



Although the applicable federal motor safety laws consider a tire to be worn when the treadwear indicators (TWI) become visible at approximately $\frac{1}{16}$ in (1.6 mm), we recommend that you do not allow your tires

to wear down to that level. As tread depth approaches $\frac{1}{8}$ in (3 mm), the adhesion properties on a wet road are sharply reduced.

Depending upon the weather and/or road surface (conditions), the tire traction varies widely.

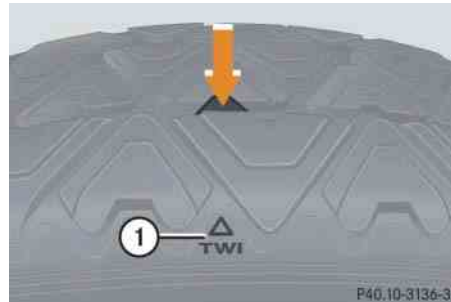

① TWI (Tread Wear Indicator)

The treadwear indicator appears as a solid band across the tread.

Storing tires

! *Keep unmounted tires in a cool, dry place with as little exposure to light as possible. Protect tires from contact with oil, grease and gasoline.*

Cleaning tires

! *Never use a round nozzle to power wash tires. The intense jet of water can result in damage to the tire.*

Always replace a damaged tire.

Tires and wheels

Direction of rotation

Unidirectional tires offer added advantages, such as better hydroplaning performance. To benefit, however, you must make sure the tires rotate in the direction specified.

An arrow on the sidewall indicates the intended direction of rotation (spinning) of the tire.

i *Spare wheels may be mounted against the direction of rotation (spinning) even with a unidirectional tire for temporary use only until the regular drive wheel has been repaired or replaced. Always observe and follow applicable temporary use restrictions and speed limitations indicated on the spare wheel.*

Loading the vehicle

Two labels on your vehicle show how much weight it may properly carry.

- 1) The Tire and Loading Information placard can be found on the driver's door B-pillar. This Tire and Loading Information placard tells you important information about the number of people that can be in the vehicle and the total weight that can be carried in the vehicle. It also contains information on the proper size and recommended tire inflation pressures for the original equipment tires on your vehicle.
- 2) The certification label, also found on the driver's door B-pillar tells you about the gross weight capacity of your vehicle, called the Gross Vehicle Weight Rating (GVWR). The GVWR includes the weight of the vehicle, all occupants, fuel and cargo. The certification label also tells you about the front and rear axle weight capacity, called the Gross Axle Weight Rating (GAWR). The GAWR

is the total allowable weight that can be carried by a single axle (front or rear). Never exceed the GVWR or GAWR for either the front axle or rear axle.



① Driver's door B-pillar

Following is a discussion on how to work with the information contained on the Tire and Loading Information placard with regards to loading your vehicle.

Tire and Loading Information

Warning!



Do not overload the tires by exceeding the specified load limit as indicated on the Tire and Loading Information placard on the driver’s door B-pillar. Overloading the tires can overheat them, possibly causing a blowout. Overloading the tires can also result in handling or steering problems, or brake failure.

Tire and Loading Information placard

i Data shown on Tire and Loading Information placard example are for illustration purposes only. Load limit data is specific to each vehicle and may vary from data shown in the illustration below. Refer to Tire and Loading Information placard on vehicle for actual data specific to your vehicle.

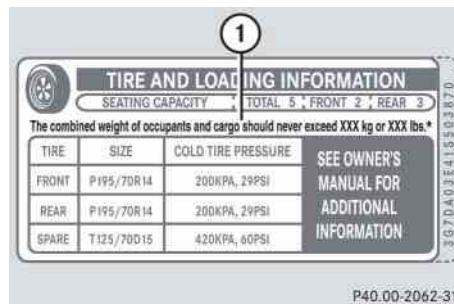

① Load limit information on the Tire and Loading Information placard

The Tire and Loading Information placard showing the load limit information is located on the driver’s door B-pillar.

► Locate the statement “The combined weight of occupants and cargo should never exceed XXX kilograms or XXX lbs.” on the Tire and Loading Information placard.

The combined weight of all occupants, cargo / luggage and trailer tongue load (if applicable) should never exceed the weight referenced in that statement.

Seating capacity

The seating capacity gives you important information on the number of occupants that can be in the vehicle. Observe front and rear seating capacity. The Tire and Loading Information placard showing the seating capacity is located on the driver’s door B-pillar (► page 334).

Tires and wheels

i Data shown on Tire and Loading Information placard example are for illustration purposes only. Seating data are specific to each vehicle and may vary from data shown in the illustration below. Refer to Tire and Loading Information placard on vehicle for actual data specific to your vehicle.

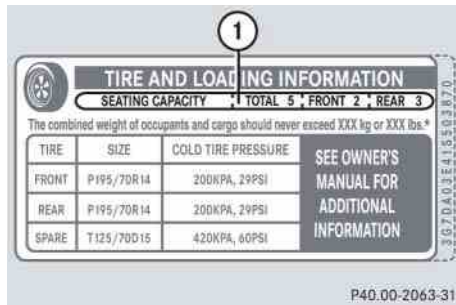

① Seating capacity information on the Tire and Loading Information placard.

Steps for determining correct load limit

The following steps have been developed as required of all manufacturers under Title 49, Code of U.S. Federal Regulations, Part 575 pursuant to the “National Traffic and Motor Vehicle Safety Act of 1966”.

Step 1

- ▶ Locate the statement “The combined weight of occupants and cargo should never exceed XXX kg or XXX lbs.” on your vehicle’s Tire and Loading Information placard.

Step 2

- ▶ Determine the combined weight of the driver and passengers that will be riding in your vehicle.

Step 3

- ▶ Subtract the combined weight of the driver and passengers from XXX kilograms or XXX lbs.

Step 4

- ▶ The resulting figure equals the available amount of cargo and luggage load capacity. For example, if the “XXX” amount equals 1400 lbs and there will be five 150 lbs passengers in your vehicle, the amount of available cargo and luggage load capacity is 650 lbs (1400-750 (5 x150) = 650 lbs).

Step 5

- ▶ Determine the combined weight of luggage and cargo being loaded on the vehicle. That weight may not safely exceed the available cargo and luggage load capacity calculated in step 4.

Step 6 (if applicable)

- ▶ If your vehicle will be towing a trailer, load from your trailer will be transferred to your vehicle. Consult this manual to determine how this reduces the available cargo and luggage load capacity of your vehicle (▷ page 338).

The following table shows examples on how to calculate total and cargo load capacities with varying seating configurations and number and size of occupants. The following examples use a load limit of 1500 lbs. **This is for illustration purposes only.** Make sure you are using the actual load limit for your vehicle stated on the vehicle’s Tire and Loading Information placard (▷ page 335).

Example	Combined weight limit of occupants and cargo from Tire and Loading Information placard	Number of occupants (driver and passengers)	Seating configuration	Occupants weight	Combined weight of all occupants	Available cargo/luggage and trailer tongue weight (total load limit weight from Tire and Loading Information placard minus combined weight of all occupants)
1	1500 lbs	4	front: 2 rear: 2	Occupant 1: 150 lbs Occupant 2: 180 lbs Occupant 3: 160 lbs Occupant 4: 140 lbs	630 lbs	1500 lbs - 630 lbs = 870 lbs
2	1500 lbs	3	front: 1 rear: 2	Occupant 1: 200 lbs Occupant 2: 190 lbs Occupant 3: 150 lbs	540 lbs	1500 lbs - 540 lbs = 960 lbs
3	1500 lbs	1	front:1	Occupant 1: 150 lbs	150 lbs	1500 lbs - 150 lbs = 1350 lbs

The higher the weight of all occupants, the less cargo and luggage load capacity is available.

For more information, see “Trailer tongue load” (> page 338).

Tires and wheels

Certification label

Even after careful determination of the combined weight of all occupants, cargo and the trailer tongue load (if applicable) (▷ page 338) as to not exceed the permissible load limit, you must make sure your vehicle never exceeds the Gross Vehicle Weight Rating (GVWR) and the Gross Axle Weight Rating (GAWR) for either the front or rear axle. You can obtain the GVWR and GAWR from the certification label. The certification label can be found on the driver's door B-pillar, see "Technical data" (▷ page 478).

Gross Vehicle Weight Rating (GVWR): The total weight of the vehicle, all occupants, all cargo, and the trailer tongue load (▷ page 338) must never exceed the GVWR.

Gross Axle Weight Rating (GAWR): The total allowable weight that can be carried by a single axle (front or rear).

To assure that your vehicle does not exceed the maximum permissible weight limits (GVWR and GAWR for front and rear axle), have the loaded vehicle (including driver, passengers and all cargo and, if applicable, trailer fully loaded) weighed on a suitable commercial scale.

Trailer tongue load

The tongue load of any trailer is an important weight to measure because it affects the load you can carry in your vehicle. If a trailer is towed, the tongue load must be added to the weight of all occupants riding and any cargo you are carrying in the vehicle. The tongue load typically is ten percent of the trailer weight and everything loaded in it.

Your Mercedes-Benz has been designed primarily to carry passengers and their cargo. Mercedes-Benz does not recommend trailer towing with your vehicle.

Recommended tire inflation pressure

Warning!



Follow recommended tire inflation pressures.

Do not underinflate tires. Underinflated tires wear excessively and / or unevenly, adversely affect handling and fuel economy, and are more likely to fail from being overheated.

Do not overinflate tires. Overinflated tires can adversely affect handling and ride comfort, wear unevenly, increase stopping distance, and result in sudden deflation (blowout) because they are more likely to become punctured or damaged by road debris, potholes etc.

Do not overload the tires by exceeding the specified load limit as indicated on the Tire and Loading Information placard on the driver's door B-pillar. Overloading the tires can overheat them, possibly causing a blowout. Overloading the tires can also result in handling or steering problems, or brake failure.

Your vehicle is equipped with a Tire and Loading Information placard located on the driver's door B-pillar (▷ page 334).

The tire inflation pressure should be checked regularly and should only be adjusted on cold tires. The tires can be considered cold if the vehicle has been parked for at least three hours or driven less than 1 mile (1.6 km).

Follow recommended cold tire inflation pressures listed on the Tire and Loading Information placard on the driver's door B-pillar.

Keeping the tires properly inflated provides the best handling, tread life and riding comfort.

In addition to the Tire and Loading Information placard on the driver's door B-pillar, also consult the tire inflation pressure label (if available) on the fuel filler flap (▷ page 320) for any additional information pertaining to special driving situations. For more information, see "Important notes on tire inflation pressure" (▷ page 340).

 *Data shown on Tire and Loading Information placard example are for illustration purposes only. Tire data are specific to each vehicle and may vary from data shown in the illustration below. Refer to Tire and Loading Information placard on vehicle for actual data specific to your vehicle.*

Tires and wheels

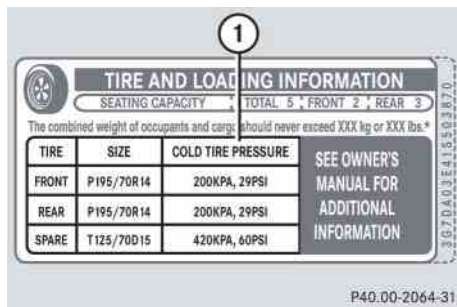

① Tire and Loading Information placard with recommended cold tire inflation pressures

The Tire and Loading Information placard lists the recommended cold tire inflation pressures for maximum loaded vehicle weight. The tire inflation pressures listed apply to the tires installed as original equipment.

Important notes on tire inflation pressure

Warning!



If the tire inflation pressure drops repeatedly:

- Check the tires for punctures from foreign objects.
- Check to see whether air is leaking from the valves or from around the rim.

Tire temperature and tire inflation pressure are also increased while driving, depending on the driving speed and the tire load.

If you will be driving your vehicle at high speeds of 100 mph (160 km/h) or higher, where it is legal and conditions allow, consult the tire inflation pressure label on the inside of the fuel filler flap (if available) on how to adjust the cold tire inflation pressure. If you do not adjust the tire inflation pressure, excessive heat can build up and result in sudden tire failure.

If your vehicle is not equipped with the tire inflation pressure label on the inside of the fuel filler flap, contact an authorized Mercedes-Benz Center for proper tire inflation pressure.

i *Driving comfort may be reduced when the tire inflation pressure is adjusted to the value for speeds above 100 mph (160 km/h) as specified on the tire inflation pressure label (if available) located on the inside of the fuel filler flap.*

Be sure to readjust the tire inflation pressure for normal driving speeds. You should wait until the tires are cold before adjusting the tire inflation pressure.

Some vehicles may have supplemental tire inflation pressure information for vehicle loads less than the maximum loaded vehicle condition. If such information is provided, it can be found on the tire inflation pressure label (if available) located on the inside of the fuel filler flap.

Tire inflation pressure changes by approximately 1.5 psi (0.1 bar) per 18°F (10°C) of air temperature change. Keep this in mind

when checking tire inflation pressure where the temperature is different from the outside temperature.

Checking tire inflation pressure

Regularly check your tire inflation pressure at least once a month.

Check and adjust the tire inflation pressure when the tires are cold. The tires can be considered cold if the vehicle has been parked for at least three hours or driven less than one mile (1.6 km).

If you check the tire inflation pressure when the tires are warm (the vehicle has been driven for several miles or sitting less than three hours), the reading will be approximately 4 psi (0.3 bar) higher than the cold reading. This is normal. Do not let air out to match the specified cold tire inflation pressure. Otherwise, the tire will be underinflated.

Warning!



Follow recommended tire inflation pressures.

Do not underinflate tires. Underinflated tires wear excessively and / or unevenly, adversely affect handling and fuel economy, and are more likely to fail from being overheated.

Do not overinflate tires. Overinflated tires can adversely affect handling and ride comfort, wear unevenly, increase stopping distance, and result in sudden deflation (blowout) because they are more likely to become punctured or damaged by road debris, potholes etc.

Do not overload the tires by exceeding the specified load limit as indicated on the Tire and Loading Information placard on the driver's door B-pillar. Overloading the tires can overheat them, possibly causing a blowout. Overloading the tires can also result in handling or steering problems, or brake failure.

Checking tire inflation pressure manually

Follow the steps below to achieve correct tire inflation pressure:

- ▶ Remove the cap from the valve on one tire.
- ▶ Firmly press a tire gauge onto the valve.
- ▶ Read tire inflation pressure on tire gauge and check against the recommended tire inflation pressure on the Tire and Loading Information placard on the driver's door B-pillar (▷ page 334). If necessary, add air to achieve the recommended tire inflation pressure.

i *If you have overfilled the tire, release tire inflation pressure by pushing the metal stem of the valve with e.g. a tip of a pen. Then recheck the tire inflation pressure with the tire gauge.*

- ▶ Install the valve cap.
- ▶ Repeat this procedure for each tire.

Tires and wheels

Run Flat Indicator (Canada only)

While the vehicle is being driven, the Run Flat Indicator monitors the set tire inflation pressures by evaluating each wheel's rotational speed. This allows the system to detect a significant loss of pressure in a tire. If a wheel's rotational speed changes due to falling tire inflation pressure, you will see a corresponding warning message in the multifunction display.

The Run Flat Indicator may function in a restricted manner or with a delay

- if snow chains are mounted to the vehicle
- in presence of ice and snow
- if you are driving on a loose surface (e.g. sand or gravel)
- if you are driving in a very sporty manner (involving rapid acceleration or high speeds in curves)
- if you are driving with the roof loaded (CLK coupe) or very heavy cargo

Warning!



When the multifunction display shows the message **Tire Pressure Check Tires**, one or more of your tires is significantly underinflated. You should stop and check your tires as soon as possible, and inflate them to the proper tire inflation pressure as indicated on the vehicle's Tire and Loading Information placard or, if available, on the tire inflation pressure label. Driving on a significantly under-inflated tire causes the tire to overheat and can lead to tire failure. Underinflation also reduces fuel efficiency and tire tread life, and may affect the vehicle's handling and stopping ability. Each tire, including the spare, should be checked monthly when cold and set to the recommended tire inflation pressure as specified on the Tire and Loading Information placard on the driver's door B-pillar (▷ page 334) or, if available, on the tire inflation pressure label located on the inside of the fuel filler flap (▷ page 320).

Warning!



The Run Flat Indicator does not provide a warning for wrongly selected tire inflation pressures. Always adjust tire inflation pressure according to the Tire and Loading Information placard on the driver's door B-pillar (▷ page 334) or, if available, on the tire inflation pressure label located on the inside of the fuel filler flap (▷ page 320).

The Run Flat Indicator does not replace regular checks of the tire inflation pressures since a gradual pressure loss in more than one tire cannot be detected by the Run Flat Indicator.

The Run Flat Indicator is not able to issue a warning due to a sudden dramatic loss of tire inflation pressure (e.g. tire blowout caused by a foreign object). In this case bring the vehicle to a halt by carefully applying the brakes and avoiding abrupt steering maneuvers.

Restarting the Run Flat Indicator

The tire inflation pressure monitor must be restarted in the following situations:



- If you have changed the tire inflation pressure
- If you have replaced the wheels or tires
- If you have installed new wheels or tires
- ▶ Using the Tire and Loading Information placard on the driver's door B-pillar or, if available, the tire inflation pressure label on the inside of the fuel filler flap, make sure the tire inflation pressure of all four tires is correct.

Warning!



The Run Flat Indicator can only warn you in a reliable manner if you have set the correct tire inflation pressures for each tire.

If an incorrect tire inflation pressure was set, the system will monitor the pressure according to the incorrect value.

- ▶ Switch on the ignition (▷ page 38).
Make sure the standard display menu appears in the multifunction display (▷ page 147).
- ▶ Press button  or  repeatedly until the following message appears in the multifunction display:



- ▶ Press the reset button in the instrument cluster (▷ page 138).
The following message will appear in the multifunction display:

Restart
Run Flat Indicator?
Cancel
Yes

If you wish to confirm activation:

- ▶ Press button .

The following message will appear in the multifunction display:

Run Flat Indicator
Restarted

After a certain “learning phase”, the Run Flat Indicator checks the set pressure values for all four tires.

If you wish to cancel activation:

- ▶ Press button .

or

- ▶ Wait until the message

Restart
Run Flat Indicator?
Cancel
Yes
disappears.

Tires and wheels

Checking tire pressure electronically with the Tire Pressure Monitoring System (TPMS), (USA only)

i The Tire Pressure Monitoring System (TPMS) is equipped with a combination low tire pressure/TPMS malfunction telltale in the instrument cluster (▷ page 29). Depending on how the telltale illuminates, it indicates a low tire pressure condition or a malfunction in the TPMS system itself:

- If the telltale illuminates continuously, one or more of your tires is significantly underinflated. There is no malfunction in the TPMS.
- If the telltale flashes for 60 seconds and then stays illuminated, the TPMS system itself is not operating properly.

i This device complies with Part 15 of the FCC Rules. Operation is subject to the following two conditions:

- (1) This device may not cause harmful interference, and
- (2) this device must accept any interference received, including interference that may cause undesired operation.

Any unauthorized modification to this device could void the user's authority to operate the equipment.

The TPMS only functions on wheels that are equipped with the proper electronic sensors. It monitors the tire inflation pressure, as selected by the driver, in all four tires. A warning is issued to alert you to a decrease in pressure in one or more of the tires.

Warning!



The TPMS does not indicate a warning for wrongly selected inflation pressures. Always adjust tire inflation pressure according to the Tire and Loading Information placard on the driver's door B-pillar or, if available, the supplemental tire pressure information on the inside of the fuel filler flap.

The TPMS is not able to issue a warning due to a sudden dramatic loss of pressure (e.g. tire blowout caused by a foreign object). In this case bring the vehicle to a halt by carefully applying the brakes and avoiding abrupt steering maneuvers.

Warning!

Each tire, including the Minispare, should be checked monthly when cold and inflated to the inflation pressure recommended by the vehicle manufacturer on the Tire and Loading Information placard or, if available, on the tire inflation pressure label. If your vehicle has tires of a different size than the size indicated on the Tire and Loading Information placard or, if available, the tire inflation pressure label, you should determine the proper tire inflation pressure for those tires.

As an added safety feature, your vehicle has been equipped with a tire pressure monitoring system (TPMS) that illuminates a low tire pressure telltale when one or more of your tires is significantly underinflated. Accordingly, when the low tire pressure telltale illuminates, you should stop and check your tires as soon as possible, and inflate them to the proper pressure. Driving on a significantly underinflated tire causes the tire to overheat and can lead to tire failure.

Underinflation also reduces fuel efficiency and tire tread life, and may affect the vehicle's handling and stopping ability. Please note that the TPMS is not a substitute for proper tire maintenance, and it is the driver's responsibility to maintain correct tire pressure, even if underinflation has not reached the level to trigger illumination of the TPMS low tire pressure telltale.

Your vehicle has also been equipped with a TPMS malfunction indicator to indicate when the system is not operating properly. The TPMS malfunction indicator is combined with the low tire pressure telltale. When the system detects a malfunction, the telltale will flash for approximately 1 minute and then remain continuously illuminated. This sequence will continue upon subsequent vehicle start-ups as long as the malfunction exists. When the malfunction indicator is illuminated, the system may not be able to detect or signal low tire pressure as intended.

TPMS malfunctions may occur for a variety of reasons, including the installation of replacement or alternate tires or wheels on the vehicle that prevent the TPMS from functioning properly. Always check the TPMS malfunction telltale after replacing one or more tires or wheels on your vehicle to ensure that the replacement or alternate tires and wheels allow the TPMS to continue to function properly.

i *If a condition causing the TPMS to malfunction develops, it may take up to 10 minutes for the system to signal a malfunction using the TPMS telltale flashing and illumination sequence.*

The telltale extinguishes after a few minutes driving if the malfunction has been corrected.

i *Operating radio transmission equipment (e.g. wireless headsets, two-way radios) in or near the vehicle could cause the TPMS to malfunction.*

Tires and wheels

Tire inflation pressure warnings

If the system detects a significant loss of tire inflation pressure in one or more than one tire, a message appears in the multifunction display.



Example illustration

In addition, a warning signal sounds.

Restarting the TPMS

Warning!







It is the driver's responsibility to calibrate the TPMS on the recommended cold inflation pressure. Underinflated tires affect the ability to steer or brake the vehicle. You might lose control over the vehicle.

The TPMS must be restarted when you have adjusted the tire inflation pressure to a new level (e.g. because of different load or driving conditions). The TPMS is then recalibrated to the current tire inflation pressures.

- ▶ Using the Tire and Loading Information placard on the driver's door B-pillar (▷ page 334) or, if available, the supplemental tire inflation pressure information on the inside of the fuel filler flap (▷ page 320), make sure the tire inflation pressure of all four tires is correct.

i Restart the TPMS after adjusting the tire inflation pressure to the inflation pressure recommended for the vehicle operating condition. Tire pressure should only be adjusted on cold tires. Observe the recommended tire inflation pressure on the Tire and Loading Information placard on the driver's door B-pillar (▷ page 334). Some vehicles may have supplemental tire inflation pressure information for driving at high speeds (▷ page 340) or for vehicle loads less than the maximum loaded vehicle condition (▷ page 335). If such information is provided, it can be found on the inside of the fuel filler flap.

- ▶ Switch on the ignition (▷ page 38).
- ▶ Press button  or  on the multifunction steering wheel repeatedly until the standard display menu appears in the multifunction display (▷ page 147).

- ▶ Press button  or  repeatedly until the following message appears in the multifunction display:



Tire Pressure
Monitor Active
Menu: R-Button



- ▶ Press the reset button ( page 138).

The following message will appear in the multifunction display:

Restart tire
tire pressure
monitor?
Cancel
Yes

- ▶ Press button  or  to selected Yes.

- ▶ Press the  button.

The following message will appear in the multifunction display:

Tire Pressure
Monitor
Restarted

After driving a few minutes the current tire inflation pressure values are accepted as reference pressures and then monitored.

If you wish to cancel activation:

- ▶ Press button  or  to selected Cancel.

- ▶ Press the  button.

Potential problems associated with underinflated and overinflated tires

Underinflated tires

Underinflated tires can:

- cause excessive and uneven tire wear
- adversely affect fuel economy
- lead to tire failure from being overheated
- adversely affect handling characteristics

Warning!



Follow recommended tire inflation pressures.

Do not underinflate tires. Underinflated tires wear excessively and / or unevenly, adversely affect handling and fuel economy, and are more likely to fail from being overheated.

Tires and wheels

Overinflated tires

Overinflated tires can:

- adversely affect handling characteristics
- cause uneven tire wear
- be more prone to damage from road hazards
- adversely affect ride comfort
- increase stopping distance

Warning!



Follow recommended tire inflation pressures.

Do not overinflate tires. Overinflated tires can adversely affect handling and ride comfort, wear unevenly, increase stopping distance, and result in sudden deflation (blowout) because they are more likely to become punctured or damaged by road debris, potholes etc.

MOExtended system*

The *MOExtended* system allows you to continue driving your vehicle even if there is a total loss of pressure in one or more tires.

You may only use the *MOExtended* system in conjunction with the Run Flat Indicator (▷ page 342).

For information on driving in the event of pressure loss in one or more tires (emergency mode), see the “Practical hints” section (▷ page 463).

Tire labeling

Besides tire name (sales designation) and manufacturer name, a number of markings can be found on a tire.

Following are some explanations for the markings on your vehicle’s tires:

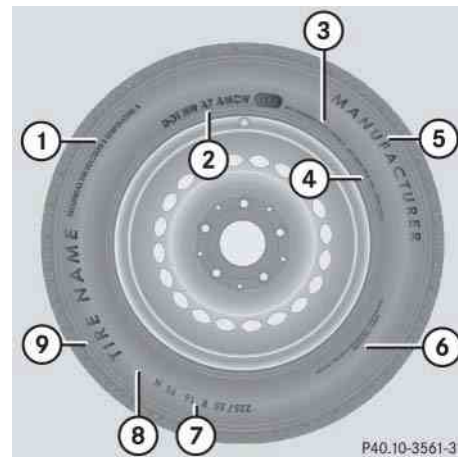

- ① Uniform Quality Grading Standards
(▷ page 356)
- ② DOT, Tire Identification Number (TIN)
(▷ page 353)
- ③ Maximum tire load (▷ page 354)
- ④ Maximum tire inflation pressure
(▷ page 355)
- ⑤ Manufacturer
- ⑥ Tire ply material (▷ page 357)
- ⑦ Tire size designation, load and speed rating (▷ page 349)
- ⑧ Load identification (▷ page 352)
- ⑨ Tire name

i For illustration purposes only. Actual data on tires are specific to each vehicle and may vary from data shown in above illustration.

For more information, see “Rims and tires”
(▷ page 482).

Tire size designation, load and speed rating

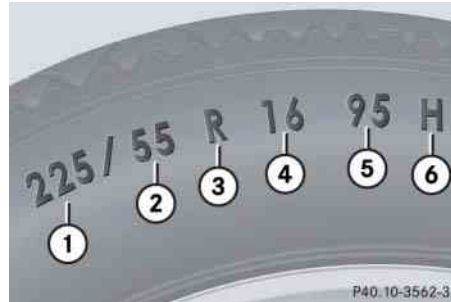

- ① Tire width
- ② Aspect ratio in %
- ③ Radial tire code
- ④ Rim diameter
- ⑤ Tire load rating
- ⑥ Tire speed rating

i For illustration purposes only. Actual data on tires are specific to each vehicle and may vary from data shown in above illustration.

General:

Depending on the design standards used, the tire size molded into the sidewall may have no letter or a letter preceding the tire size designation.

No letter preceding the size designation (as illustrated above): Passenger car tire based on European design standards.

Letter “P” preceding the size designation: Passenger car tire based on U.S. design standards.

Letter “LT” preceding the size designation: Light Truck tire based on U.S. design standards.

Letter “T” preceding the size designation: Temporary spare tires which are high pressure compact spares designed for temporary emergency use only.

Tires and wheels

Tire width

The tire width ① (▷ page 349) indicates the nominal tire width in mm.

Aspect ratio

The aspect ratio ② (▷ page 349) is the dimensional relationship between tire section height and section width and is expressed in percentage. The aspect ratio is arrived at by dividing section height by section width.

Tire code

The tire code ③ (▷ page 349) indicates the tire construction type. The “R” stands for radial tire type. Letter “D” means diagonal or bias ply construction; letter “B” means belted-bias ply construction.

At the tire manufacturer’s option, any tire with a speed capability above 149 mph (240 km/h) can include a “ZR” in the size designation (for example: 245/40 ZR 18). For additional information, see “Tire speed rating” (▷ page 351).

Rim diameter

The rim diameter ④ (▷ page 349) is the diameter of the bead seat, not the diameter of the rim edge. Rim diameter is indicated in inches (in).

Tire load rating

The tire load rating ⑤ (▷ page 349) is a numerical code associated with the maximum load a tire can support.

For example, a load rating of 91 corresponds to a maximum load of 1356 lbs (615 kg) the tire is designed to support. See also “Maximum tire load” (▷ page 354) where the maximum load associated with the load index is indicated in kilograms and lbs.

Warning!



The tire load rating must always be at least half of the GAWR (▷ page 358) of your vehicle. Otherwise, tire failure may be the result which may cause an accident and/or serious personal injury to you or others.

Always replace rims and tires with the same designation, manufacturer and type as shown on the original part.

Warning!



Do not overload the tires by exceeding the specified load limit as indicated on the Tire and Loading Information placard located on the driver’s door B-pillar. Overloading the tires can overheat them, possibly causing a blowout. Overloading the tires can also result in handling or steering problems, or brake failure.

For additional information on tire load rating, see “Load identification” (▷ page 352).

i Tire load rating ⑤ (▷ page 349) and tire speed rating ⑥ (▷ page 349) are also referred to as “service description”.

Tire speed rating

The tire speed rating ⑥ (▷ page 349) indicates the approved maximum speed for the tire.

Warning!



Even when permitted by law, never operate a vehicle at speeds greater than the maximum speed rating of the tires.

Exceeding the maximum speed for which tires are rated can lead to sudden tire failure, causing loss of vehicle control and possibly resulting in an accident and/or personal injury and possible death, for you and for others.

i Tire load rating ⑤ (▷ page 349) and tire speed rating ⑥ (▷ page 349) are also referred to as “service description”.

Summer tires

Index	Speed rating
Q	up to 100 mph (160 km/h)
R	up to 106 mph (170 km/h)
S	up to 112 mph (180 km/h)
T	up to 118 mph (190 km/h)
H	up to 130 mph (210 km/h)
V	up to 149 mph (240 km/h)
W	up to 168 mph (270 km/h)
Y	up to 186 mph (300 km/h)
(Y)	above 186 mph (300 km/h)
ZR	above 149 mph (240 km/h)

- At the tire manufacturer’s option, any tire with a speed capability above 149 mph (240 km/h) can include a “ZR” in the size designation (for example: 245/40 ZR18). To determine the maximum speed capability of the tire, the service description for the tire must be referred to. The service description is comprised of the tire load rating ⑤ (▷ page 349) and the tire speed rating ⑥ (▷ page 349).

If your tire includes “ZR” in the size designation and no service description ⑤ and ⑥ (▷ page 349) is given, the tire manufacturer must be consulted for the maximum speed capability.

Tires and wheels

If a service description ⑤ and ⑥ (▷ page 349) is given, the speed capability is limited by the speed symbol in the service description.

Example: 245/40 ZR18 97Y.

In this example, “97Y” is the service description. The letter “Y” designates the speed rating and the speed capability of the tire is limited to 186 mph (300 km/h).

- Any tire with a speed capability above 186 mph (300 km/h) must include a “ZR” in the size designation AND the service description must be placed in parenthesis. Example: 275/40 ZR 18 (99Y). The “(Y)” speed rating in parenthesis designates the maximum speed capability of the tire as being above 186 mph (300 km/h). Consult the tire manufacturer for the actual maximum permissible speed of the tire.

All-season and winter tires

Index	Speed rating
Q M+S ¹	up to 100 mph (160 km/h)
T M+S ¹	up to 118 mph (190 km/h)
H M+S ¹	up to 130 mph (210 km/h)
V M+S ¹	up to 149 mph (240 km/h)

¹ or M+S  for winter tires.

i Not all M+S rated tires provide special winter performance. Make sure the tires you use show M+S and the mountain/snowflake  marking on the tire sidewall. These tires meet specific snow traction performance requirements of the Rubber Manufacturers Association (RMA) and the Rubber Association of Canada (RAC) and have been designed specifically for use in snow conditions.

Load identification



① Load identification

i For illustration purposes only. Actual data on tires are specific to each vehicle and may vary from data shown in above illustration.

In addition to tire load rating, special load identification ① may be molded into the tire sidewall following the letter designating the tire speed rating (▷ page 349).

No specification given: absence of any text (like in above example) indicates a standard load (SL) tire.

XL or Extra Load: designates an extra load (or reinforced) tire.

Light Load: designates a light load tire.

C, D, E: designates load range associated with the maximum load a tire can carry at a specified pressure.

DOT, Tire Identification Number (TIN)

U.S. tire regulations require each new tire manufacturer or tire retreader to mold a TIN into or onto a sidewall of each tire produced.

The TIN is a unique identifier which facilitates efforts by tire manufacturers to notify purchasers in recall situations or other safety matters concerning tires and gives purchasers the means to easily identify such tires.

The TIN is comprised of “Manufacturer’s identification mark”, “Tire size”, “Tire type code” and “Date of manufacture”.

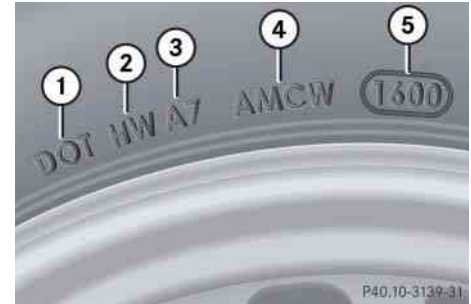

- ① DOT
- ② Manufacturer’s identification mark
- ③ Tire size
- ④ Tire type code (at the option of the tire manufacturer)
- ⑤ Date of manufacture

i For illustration purposes only. Actual data on tires are specific to each vehicle and may vary from data shown in above illustration.

Tires and wheels

DOT (Department of Transportation)

A tire branding symbol ① (▷ page 353) which denotes the tire meets requirements of the U.S. Department of Transportation.

Manufacturer's identification mark

The manufacturer's identification mark ② (▷ page 353) denotes the tire manufacturer.

New tires have a mark with two symbols.

Retreaded tires have a mark with four symbols. For more information on retreaded tires, see (▷ page 331).

Tire size

The code ③ (▷ page 353) indicates the tire size.

Tire type code

The code ④ (▷ page 353) may, at the option of the manufacturer, be used as a descriptive code for identifying significant characteristics of the tire.

Date of manufacture

The date of manufacture ⑤ (▷ page 353) identifies the week and year of manufacture.

The first two figures identify the week, starting with "01" to represent the first full week of the calendar year. The second two figures represent the year.

For example, "3202" represents the 32nd week of 2002.

Maximum tire load



① Maximum tire load rating

i For illustration purposes only. Actual data on tires are specific to each vehicle and may vary from data shown in above illustration.

The maximum tire load is the maximum weight the tires are designed to support.

Warning!

Do not overload the tires by exceeding the specified load limit as indicated on the Tire and Loading Information placard located on the driver's door B-pillar. Overloading the tires can overheat them, possibly causing a blowout. Overloading the tires can also result in handling or steering problems, or brake failure.

For more information on tire load rating (▷ page 350).

For information on calculating total and cargo load capacities (▷ page 336).

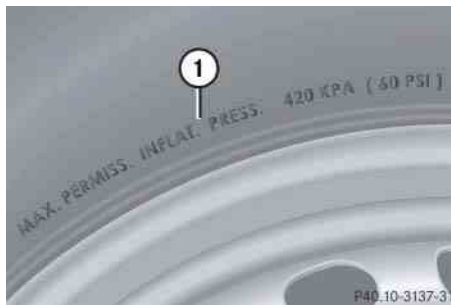
Maximum tire inflation pressure

① Maximum permissible tire inflation pressure

i *For illustration purposes only. Actual data on tires are specific to each vehicle and may vary from data shown in above illustration.*

This is the maximum permissible tire inflation pressure for the tire.

Always follow the recommended tire inflation pressure (▷ page 339) for proper tire inflation.

Warning!

Never exceed the max. tire inflation pressure. Follow recommended tire inflation pressures.

Do not underinflate tires. Underinflated tires wear excessively and / or unevenly, adversely affect handling and fuel economy, and are more likely to fail from being overheated.

Do not overinflate tires. Overinflated tires can adversely affect handling and ride comfort, wear unevenly, increase stopping distance, and result in sudden deflation (blowout) because they are more likely to become punctured or damaged by road debris, potholes etc.

Tires and wheels

Uniform Tire Quality Grading Standards (U.S. vehicles)

Tire manufacturers are required to grade tires based on three performance factors: treadwear, traction and temperature resistance.

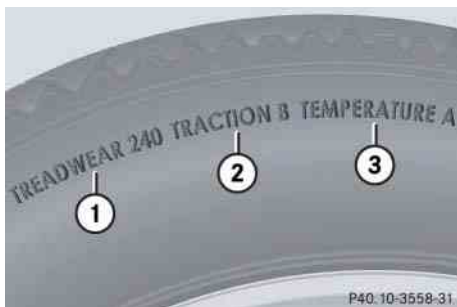

- ① Treadwear
- ② Traction
- ③ Temperature resistance

i For illustration purposes only. Actual data on tires are specific to each vehicle and may vary from data shown in above illustration.

Quality grades can be found, where applicable, on the tire sidewall between tread shoulder and maximum section width. For example:

Treadwear	Traction	Temperature
200	AA	A

All passenger car tires must conform to federal safety requirements in addition to these grades.

Treadwear

The treadwear grade is a comparative rating based on the wear rate of the tire when tested under controlled conditions on a specified government test course. For example, a tire graded 150 would wear one and one-half ($1\frac{1}{2}$) times as well on the government course as a tire graded 100. The relative performance of tires depends upon the actual conditions of their use, however, and may depart significantly

from the norm due to variations in driving habits, service practices and differences in road characteristics and climate.

Traction

The traction grades, from highest to lowest, are AA, A, B, and C. Those grades represent the tire's ability to stop on wet pavement as measured under controlled conditions on specified government test surfaces of asphalt and concrete. A tire marked C may have poor traction performance.

Warning!



The traction grade assigned to this tire is based on straight-ahead braking traction tests, and does not include acceleration, cornering, hydroplaning, or peak traction characteristics.

Temperature

The temperature grades are A (the highest), B, and C, representing the tire's resistance to the generation of heat and its ability to dissipate heat when tested under controlled conditions on a specified indoor laboratory test wheel. Sustained high temperature can cause the material of the tire to degenerate and reduce tire life, and excessive temperature can lead to sudden tire failure. The grade C corresponds to a level of performance which all passenger car tires must meet under the Federal Motor Vehicle Safety Standard No. 109. Grades B and A represent higher levels of performance on the laboratory test wheel than the minimum required by law.

Warning!



The temperature grade for this tire is established for a tire that is properly inflated and not overloaded. Excessive speed, underinflation, or excessive loading, either separately or in combination, can cause excessive heat build-up and possible tire failure.

Tire ply material



- ① Pliés in sidewall
- ② Pliés under tread

i For illustration purposes only. Actual data on tires are specific to each vehicle and may vary from data shown in above illustration.

This marking tells you about the type of cord and number of plies in the sidewall and under the tread.

Tires and wheels

Tire and loading terminology

Accessory weight

The combined weight (in excess of those standard items which may be replaced) of automatic transmission, power steering, power brakes, power windows, power seats, radio, and heater, to the extent that these items are available as factory-installed equipment (whether installed or not).

Air pressure

The amount of air inside the tire pressing outward on each square inch of the tire. Air pressure is expressed in pounds per square inch (psi), or kilopascal (kPa) or bars.

Aspect ratio

Dimensional relationship between tire section height and section width expressed in percentage.

Bar

Another metric unit for air pressure. There are 14.5038 pounds per square inch (psi) to 1 bar; there are 100 kilopascals (kPa) to 1 bar.

Bead

The tire bead contains steel wires wrapped by steel cords that hold the tire onto the rim.

Cold tire inflation pressure

Tire inflation pressure when your vehicle has been sitting for at least 3 hours or driven no more than 1 mile (1.6 km).

Curb weight

The weight of a motor vehicle with standard equipment including the maximum capacity of fuel, oil, and coolant, and, if so equipped, air conditioning and additional optional equipment, but without passengers and cargo.

DOT (Department of Transportation)

A tire branding symbol which denotes the tire meets requirements of the U.S. Department of Transportation.

GAWR (Gross Axle Weight Rating)

The GAWR is the maximum permissible axle weight. The gross vehicle weight on each axle must never exceed the GAWR for the front and rear axle indicated on the certification label located on the driver's door B-pillar.

GVW (Gross Vehicle Weight)

The GVW comprises the weight of the vehicle including fuel, tools, spare wheel, installed accessories, passengers and cargo and, if applicable, trailer tongue load. The GVW must never exceed the GVWR indicated on the certification label located on the driver's door B-pillar.

GVWR (Gross Vehicle Weight Rating)

This is the maximum permissible vehicle weight of the fully loaded vehicle (weight of the vehicle including all options, passengers, fuel, and cargo and, if applicable, trailer tongue load). It is indicated on certification label located on the driver's door B-pillar.

Kilopascal (kPa)

The metric unit for air pressure. There are 6.9 kPa to 1 psi; another metric unit for air pressure is bars. There are 100 kilopascals (kPa) to 1 bar.

Maximum load rating

The maximum load in kilograms and pounds that can be carried by the tire.

Maximum loaded vehicle weight

The sum of curb weight, accessory weight, total load limit and production options weight.

Maximum tire inflation pressure

This number is the greatest amount of air pressure that should ever be put in the tire under normal driving conditions.

Normal occupant weight

The number of occupants the vehicle is designed to seat, multiplied by 68 kilograms (150 lbs).

Occupant distribution

The distribution of occupants in a vehicle at their designated seating positions.

Production options weight

The combined weight of those installed regular production options weighing over 5 lbs (2.3 kilograms) in excess of those standard items which they replace, not previously considered in curb weight or accessory weight, including heavy duty brakes, ride levelers, roof rack, heavy duty battery, and special trim.

PSI (Pounds per square inch)

A standard unit of measure for air pressure -> bar, kilopascal (kPa).

Recommended tire inflation pressure

The recommended tire inflation pressure is listed on Tire and Loading Information placard located on driver's door B-pillar for normal driving conditions and provides best handling, tread life and riding comfort. If so equipped, supplemental information pertaining to special driving situations can be found on the tire inflation pressure label on the inside of the fuel filler flap.

Rim

A metal support for a tire or a tire and tube assembly upon which the tire beads are seated.

Sidewall

The portion of a tire between the tread and the bead.

Tires and wheels

TIN (Tire Identification Number)

Unique identifier which facilitates efforts by tire manufacturers to notify purchasers in recall situations or other safety matters concerning tires and gives purchases the means to easily identify such tires. The TIN is comprised of “Manufacturer’s identification mark”, “Tire size”, “Tire type code” and “Date of manufacture”.

Tire load rating

Numerical code associated with the maximum load a tire can support.

Tire ply composition and material used

This indicates the number of plies or the number of layers of rubber-coated fabric in the tire tread and sidewall. Tire manufacturers also must indicate the ply materials in the tire and sidewall, which include steel, nylon, polyester, and others.

Tire speed rating

Part of tire designation; indicates the speed range for which a tire is approved.

Total load limit

Rated cargo and luggage load plus 68 kilograms (150 lbs) times the vehicle’s designated seating capacity.

Traction

Force exerted by the vehicle on the road via the tires. The amount of grip provided.

Tread

The portion of a tire that comes into contact with the road.

Treadwear indicators

Narrow bands, sometimes called “wear bars” that show across the tread of a tire when only $\frac{1}{16}$ in (1.6 mm) of tread remains.

Uniform Tire Quality Grading Standards

A tire information system that provides consumers with ratings for a tire’s traction, temperature and treadwear. Ratings are determined by tire manufacturers using government testing procedures. The ratings are molded into the sidewall of the tire.

Vehicle maximum load on the tire

Load on an individual tire that is determined by distributing to each axle its share of the maximum loaded vehicle weight and dividing it by two.

Rotating tires

Warning!



Rotate front and rear wheels only if the tires are of the same dimension.

If your vehicle is equipped with mixed-size tires (different tire dimensions front vs. rear), tire rotation is not possible.

Tire rotation can be performed on vehicles with tires of the same dimension all around. If your vehicle is equipped with tires of the same dimension all around, tires can be rotated, observing a front-to-rear rotation pattern that will maintain the intended rotation (spinning) direction of the tire (▷ page 334).

In some cases, such as when your vehicle is equipped with mixed-size tires (different tire dimension front vs. rear), tire rotation is not possible.

If applicable to your vehicle's tire configuration, tires can be rotated according to the tire manufacturer's recommended intervals in the tire manufacturer's warranty pamphlet located in your vehicle literature portfolio. If none is available, tires should be rotated every 3000 to 6000 miles (5000 to 10000 km), or sooner if necessary, according to the degree of tire wear. The same rotation (spinning) direction must be maintained (▷ page 334).

Rotate tires before the characteristic tire wear pattern becomes visible (shoulder wear on front tires and tread center wear on rear tires).

Thoroughly clean the mounting face of wheels and brake disks, i.e. the inner side of the wheels/tires, during each rotation. Check for and ensure proper tire inflation pressure.

Warning!



Have the tightening torque checked after changing a wheel. Wheels could become loose if not tightened with a torque of 80 lb-ft (110 Nm).

Only use Genuine Mercedes-Benz wheel bolts specified for your vehicle's rims.

For information on wheel change, see the "Practical hints" section (▷ page 422) and (▷ page 452).

Winter driving

Before the onset of winter, have your vehicle winterized at an authorized Mercedes-Benz Center. This service includes:

- Check of anticorrosion and antifreeze concentration.
- Addition of cleaning concentrate to the water of the windshield and headlamp cleaning system. Add MB Concentrate “MB SummerFit” to a premixed windshield washer solvent/antifreeze which is formulated for temperatures below freezing point (▷ page 496).
- Battery test. Battery capacity drops with decreasing ambient temperature. A well charged battery helps to make sure the engine can be started even at low ambient temperatures.
- Tire change.

Winter tires

Always use winter tires at temperatures below 45°F (7°C) and whenever wintry road conditions prevail. Not all M+S rated tires provide special winter performance. Make sure the tires you use show the mountain/snowflake  marking on the tire sidewall. These tires meet specific snow traction performance requirements of the Rubber Manufacturers Association (RMA) and The Rubber Association of Canada (RAC) and have been designed specifically for use in snow conditions. Use of winter tires is the only way to achieve the maximum effectiveness of the ABS and the ESP® in winter operation.

For safe handling, make sure all mounted winter tires are of the same make and have the same tread design.

Warning!



Winter tires with a tread depth of less than $\frac{1}{6}$ in (4 mm) must be replaced. They are no longer suitable for winter operation.

Always observe the speed rating of the winter tires installed on your vehicle. If the maximum speed for which your tires are rated is below the speed rating of your vehicle, you must place a notice to this effect where it will be seen by the driver. Such notices are available at your tire dealer or any authorized Mercedes-Benz Center.

Warning!

If you use your spare tire when winter tires are fitted on the other wheels, be aware that the difference in tire characteristics may very well impair turning stability and that overall driving stability may be reduced. Adapt your driving style accordingly.

Have the spare tire replaced with a winter tire at the nearest authorized Mercedes-Benz Center.

Block heater (Canada only)

The engine is equipped with a block heater.

The electrical cable may be installed at an authorized Mercedes-Benz Center.

Snow chains

! Some tire sizes do not leave adequate clearance for snow chains. To help avoid serious damage to your vehicle or tires, make sure the use of snow chains is permissible as specified in the “Technical data” section of this Operator’s Manual, see “Rims and tires” (▷ page 482).

Snow chains should only be driven on snow-covered roads at speeds not higher than 30 mph (50 km/h). Remove chains as soon as possible when driving on roads without snow.

Please observe the following guidelines when using snow chains:

- Using snow chains is not permissible with all wheel/tire combinations (▷ page 482).
- Use snow chains in pairs and on rear wheels only. Follow the manufacturer's mounting instructions.

! If snow chains are mounted to the front wheels, they may scrape against the body or axle components. The tires or the vehicle could be damaged as a result.

- Only use snow chains that are approved by Mercedes-Benz. Any authorized Mercedes-Benz Center will be glad to advise you on this subject.
- Use of snow chains may be prohibited depending on location. Always check local and state laws before installing snow chains.
- Do not use snow chains on the spare wheel (▷ page 482).

i When driving with snow chains, you may wish to deactivate the ESP® (▷ page 94) before setting the vehicle in motion. This will improve the vehicle’s traction.

CLK 63 AMG:

Do not switch off the ESP® when driving in snow or with snow chains mounted.

We strongly recommend that you have your vehicle serviced at an authorized Mercedes-Benz Center, in accordance with the Maintenance Booklet at the times called for by the maintenance service indicator.

! *Failure to have the vehicle maintained in accordance with the Maintenance Booklet and maintenance service indicator at the designated times/mileage will result in vehicle damage not covered by the Mercedes-Benz Limited Warranty.*

Maintenance service indicator message



The maintenance service indicator message will notify you when the next maintenance service is due.

Starting approximately 1 month before the next maintenance service is due, one of the following messages will appear in the multifunction display while you are driving or when you switch on the ignition (example service A):

Service A Due In XXXXX Miles (Km)
Service A Due In XXX Days
Service A Due Now



The type of maintenance service due is indicated in the multifunction display:

-  Basic service (A)
-  Extended service (B)

i *The Maintenance System in your vehicle tracks distance driven and the time elapsed since the last maintenance service and calculates other maintenance service work required.*

Clearing the maintenance service indicator message

The maintenance service indicator message is automatically cleared after approximately 30 seconds when you switch on the ignition or when reaching the maintenance service threshold while driving.

You can also clear it yourself.

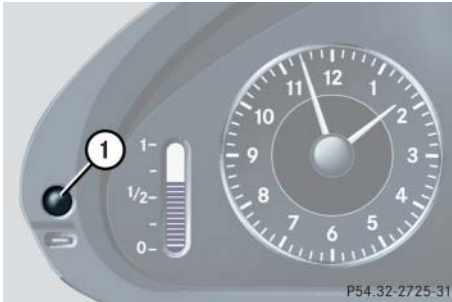

① Reset button

- ▶ Press reset button ① on the instrument cluster.

The maintenance service indicator message is cleared and the standard display appears in the multifunction display (▷ page 147).

Maintenance service term exceeded

If you have exceeded the suggested maintenance service term, you will see the following message in the multifunction display:







Service A Exceeded By XXXXX Miles (km)
Service A Exceeded By XXX Days

In addition, a signal sounds when the message appears.

Any authorized Mercedes-Benz Center will reset the maintenance service indicator following a completed maintenance service.

Calling up the maintenance service indicator display

You can call up the maintenance service indicator display at any time to check when the next maintenance service is due.

- ▶ Switch on the ignition (▷ page 40).
- ▶ Press button  or  on the multifunction steering wheel repeatedly until the standard display appears in the multifunction display (▷ page 147).
- ▶ Press button  or  until the maintenance service indicator display with the service symbol  or  and the service deadline appears in the multifunction display.

i *If the battery is disconnected, the days of disconnection will not be included in the count shown by the maintenance service indicator. To arrive at the true maintenance service deadline, you will need to subtract these days from the days shown in the maintenance service indicator message or maintenance service indicator display.*

Do not confuse the maintenance service indicator with the engine oil level indicator .

Resetting the maintenance service indicator

In the event that the maintenance service on your vehicle is not carried out at an authorized Mercedes-Benz Center, you can have the maintenance service indicator reset. The automotive maintenance facility carrying out the maintenance service will find the information for resetting the maintenance service indicator in the maintenance-relevant information for your vehicle. Such information is available from any authorized Mercedes-Benz Center or directly from Mercedes-Benz.

i *If the maintenance service indicator was inadvertently reset, have an authorized Mercedes-Benz Center correct it.*

Only reset if the proper maintenance service has been performed. Resetting the system without performing the proper service as called for by the maintenance service indicator will result in engine damage and/or other vehicle damage not covered by the Mercedes-Benz Limited Warranty.

▼ Vehicle care

Cleaning and care of vehicle

Regular and proper care will help to maintain the value of your vehicle. The best way to protect your vehicle from harmful environmental influences is to wash it and use protective treatments regularly.

Warning!



Many cleaning products can be hazardous. Some are poisonous, others are flammable. Always follow the instructions on the particular container. Always open your vehicle's doors or windows when cleaning the inside.

Never use fluids or solvents that are not designed for cleaning your vehicle.

Always lock away cleaning products and keep them out of reach of children.

While in operation, even while parked, your vehicle is subjected to varying external influences which, if gone unchecked, can attack the paintwork as well as the vehicle underbody and cause lasting damage.

Such damage is caused not only by extreme and varying climatic conditions, but also by:

- Air pollution
- Road salt
- Tar
- Gravel and stone chipping

To avoid paint damage, you should immediately remove:

- Grease and oil
- Fuel
- Coolant
- Brake fluid
- Bird droppings
- Insects
- Tree resins, etc.

Frequent washing reduces and / or eliminates the aggressiveness and potency of the above adverse influences.

More frequent washings are necessary to deal with unfavorable conditions:

- near the ocean
- in industrial areas (smoke, exhaust emissions)
- during winter operation

You should check your vehicle from time to time for stone chipping or other damage. Any damage should be repaired as soon as possible to prevent corrosion.

In doing so, do not neglect the underbody of the vehicle. A prerequisite for a thorough check is a washing of the underbody followed by a thorough inspection. Damaged areas need to be re-undercoated.

Your vehicle has been treated at the factory with a wax-base rustproofing in the body cavities which will last for the lifetime of the vehicle. Post-production treatment

is neither necessary nor recommended by Mercedes-Benz because of the possibility of incompatibility between materials used in the production process and others applied later.

We have selected car-care products and compiled recommendations which are specially matched to our vehicles and which always reflect the latest technology. You can obtain Mercedes-Benz approved car-care products at an authorized Mercedes-Benz Center.

Scratches, corrosive deposits, corrosion or damage due to negligent or incorrect care cannot always be removed or repaired with the car-care products recommended here. In such cases it is best to seek aid at an authorized Mercedes-Benz Center.

The following topics deal with the cleaning and care of your vehicle and give important “how-to” information as well as references to Mercedes-Benz approved car-care products.

Power washer

! *Follow the instructions provided by the power washer manufacturer on maintaining a distance between the vehicle and the nozzle of the power washer.*

Never use a round nozzle to power-wash tires. The intense jet of water can result in damage to the tire.

Always replace a damaged tire.

Always keep the jet of water moving across the surface. Do not aim directly at electrical parts, electrical connectors, seals, or other rubber parts.

i *Vehicles with KEYLESS-GO*:
If a door handle is hit by a strong jet of water, and a SmartKey with KEYLESS-GO* is in close proximity, i.e. within approximately 3 ft (approximately 1 m), the vehicle could be inadvertently locked or unlocked.*

Tar stains

Quickly remove tar stains before they dry and become more difficult to remove. A tar remover is recommended.

Paintwork, painted body components

! *Affixing stickers, magnets, adhesive tape or similar materials to painted body components may damage the paintwork.*

Mercedes-Benz approved Paint Care should be applied when water drops on the paint surface do not “bead up”. This should normally be done every 3 to 5 months, depending on the climate and washing detergent used.

Mercedes-Benz approved Paint Cleaner should be applied if the paint surface shows signs of embedded dirt (i.e. loss of gloss).

Do not apply any of these products or wax if your vehicle is parked in the sun or if the hood is still hot.

- ▶ Use the appropriate MB-Touch-Up Stick for quick and provisional repairs of minor paint damage (i.e. chips from stones, vehicle doors, etc.).

Engine cleaning

Prior to cleaning the engine compartment, make sure to protect electrical components and connectors from contact with water and cleaning agents.

Corrosion protection, such as MB Anticorrosion Wax, should be applied to the engine compartment after every engine cleaning. Before applying, all control linkage bushings and joints should be lubricated. The poly-V-belt and all pulleys should be protected from any wax.

Vehicle washing

In the winter, thoroughly remove all traces of road salt as soon as possible.

When washing the vehicle underbody, do not forget to clean the inner sides of the wheels.

i *Vehicles with KEYLESS-GO*:
If a door handle is hit by a strong jet of water, and a SmartKey with KEYLESS-GO* is in close proximity, i.e. within approximately 3 ft (approximately 1 m), the vehicle could be inadvertently locked or unlocked.*

Hand-wash

Do not use hot water or wash your vehicle in direct sunlight.

- ▶ Only use a mild car wash detergent, such as Mercedes-Benz approved Car Shampoo.
- ▶ Thoroughly spray the vehicle with a diffused jet of water.

Direct only a very weak spray towards the ventilation intake.

- ▶ Use plenty of water and rinse the sponge and chamois frequently.
- ▶ Rinse with clean water and thoroughly dry with a chamois.

Do not allow cleaning agents to dry on the finish.

! *Do not use scouring agents on these parts.
Never apply strong force and only use a soft, non-scratching cloth when cleaning the vehicle.
Do not attempt to wipe the surface with a dry cloth or sponge.*

Otherwise you may scratch or damage the paint.

Automatic car wash

You can have your car washed in an automatic car wash from the start. Automatic car washes without brushes are preferable.

- ▶ To protect the filter system, switch the climate control or automatic climate control to air recirculation mode, see “Air recirculation” (▷ page 191) for climate control or (▷ page 201) for automatic climate control.

! *Do not clean your vehicle in an automatic touchless car wash which uses caustic spray. Otherwise the caustic spray will damage the paint, ornamental moldings, or soft top (CLK cabriolet).*

If the vehicle is very dirty, prewash it before running it through the automatic car wash.

! Make sure the windshield wiper switch is set to **0** (▷ page 56). Otherwise, e.g. the rain sensor could activate and cause the wipers to move unintentionally. This may lead to vehicle damage.

Due to the width of the vehicle, fold in exterior rear view mirrors prior to running the vehicle through an automatic car wash to prevent damage to the mirrors.

i After running the vehicle through an automatic car wash, wipe any wax off of the windshield (▷ page 373). This will prevent smears and reduce wiping noise which can be caused by residual wax on the windshield.

When leaving the car wash, make sure the mirrors are folded out. Otherwise they may vibrate.

Soft top (CLK cabriolet)

Frequent cleaning reduces the dirt-repellent effect of the soft top.

Intensive cleaning with Mercedes-Benz car-care products for convertible soft tops can help to restore the dirt-repellent effect. Contact an authorized Mercedes-Benz Center for detailed information.

Light colored soft tops should be cleaned frequently to prevent spots and dirt from setting in, which could stain and discolor the soft top material permanently.

Incorrect cleaning and care, as well as ageing, can cause the soft-top seams to leak. Have the soft-top seams sealed at a Mercedes-Benz Center.

i If the soft top is kept in the storage compartment for a lengthy period, raise it and air out with the windows open about every 4 months.

Place a suitable cover over the soft top if you are leaving the vehicle parked in the open for an extended period of time.

! Remove bird droppings immediately. The organic acid damages the material and causes the soft top to leak.

Never use a power washer to clean the soft top, as you may damage the soft top material.

Do not use sharp-edged instruments for the removal of ice and snow.

Never use hot-wax when you run the vehicle through an automatic car wash, as you may damage the soft top material.

i *Depending on the operation mode of the car wash, there is the possibility of water drops entering the vehicle's interior. This is not an indication of a defect or malfunction in the soft top.*

Clean soft top with soft top raised and locked. Lower the soft top into the storage compartment only if the soft top is completely dry.

Dry cleaning:

- ▶ Brush the dry top with a soft-bristled brush.

Brush top always from front to rear.

Wet cleaning:

- ▶ Brush the top with a soft-bristled brush.

Wash with clear water or with a mild detergent and an ample supply of lukewarm water by wiping with a soft-bristled brush or sponge from front to rear. Then rinse thoroughly with clear water.

Wash the top only when heavily soiled.

If only parts of the top have been washed, wet the entire top and allow it to air-dry before lowering it into the storage compartment.

i *In general, regular spraying or cleaning with clear water is sufficient to keep the soft top clean.*

For cleaning soft top or wind screen never use:

- gasoline
- thinner
- tar and stain removers
- glass cleaner
- similar organic solvents

They will cause damage which is not covered by the Mercedes-Benz Limited Warranty.

Vehicle care

Ornamental moldings

For regular cleaning and care of ornamental moldings, use a damp cloth.

! Do not use chrome cleaner on ornamental moldings. Although ornamental moldings may have chrome appearance, they could be made of anodized aluminum that will be damaged when cleaned with chrome cleaner. Instead, use a damp cloth to clean those ornamental moldings.

For very dirty ornamental moldings of which you are sure are chrome-plated, use a chrome cleaner. If in doubt whether an ornamental molding is chrome-plated, contact an authorized Mercedes-Benz Center.

Headlamps, tail lamps, side markers, turn signal lenses

► Use a mild car wash detergent, such as Mercedes-Benz approved Car Shampoo, with plenty of water.

! Only use window cleaning solutions that are suitable for plastic lamp lenses. Window cleaning solutions which are not suitable may damage the plastic lamp lenses of the headlamps. Therefore, do not use abrasives, solvents or cleaners that contain solvents.

Never apply strong force and only use a soft, non-scratching cloth when cleaning the lenses. Do not attempt to wipe dirty lenses with a dry cloth or sponge.

Otherwise you may scratch or damage the lens surface.

Cleaning the Parktronic system* sensors (CLK 63 AMG (USA), Canada all vehicles)

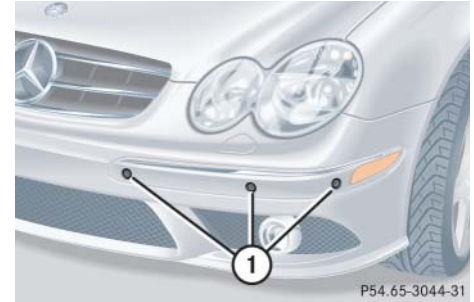

① Parktronic system* sensors in front bumper

► Use a mild car wash detergent, such as Mercedes-Benz approved Car Shampoo, with plenty of water and a soft, non-scratching cloth to clean sensors ① on the bumpers.

! Do not apply strong pressure to the sensor covers. Applying strong pressure may damage the sensor covers.

Follow the instructions provided by the power washer manufacturer on maintaining a distance between the vehicle and the nozzle of the power washer.

! To prevent scratches, never apply strong force and only use a soft, non-scratching cloth when cleaning the sensors. Do not attempt to wipe dirty sensors with a dry cloth or sponge.

Cleaning the windows and the wiper blades

! Never open the hood when the wiper arms are folded forward.

- ▶ Make sure the hood is fully closed.
- ▶ Make sure the vehicle's on-board electronics have status **0** (> page 38).

Warning!



For safety reasons, switch off wipers and remove SmartKey from starter switch (vehicles with KEYLESS-GO*: Make sure the vehicle's on-board electronics have status **0**) before cleaning the windshield and/or the wiper blades. Otherwise, the wiper motor could suddenly turn on and cause injury.

- ▶ Fold the wiper arms forward until they snap into place.

! Do not pull on the wiper blade inserts. They could tear.

- ▶ Clean the wiper blade inserts with a clean cloth and detergent solution.
- ▶ Use a soft, clean cloth and a mild window cleaning solution on all outside and inside glass surfaces.

An automotive glass cleaner is recommended.

! Fold the windshield wiper arms back onto the windshield before turning the SmartKey in the starter switch or pressing the KEYLESS-GO start/stop button (vehicles with KEYLESS-GO*).

Hold on to the wiper when folding the wiper arm back. If released, the force of the impact from the tensioning spring could crack the windshield.

! To clean the window interior, do not use a dry cloth, abrasives, solvents or cleaners containing solvents. Do not touch the inside of the front, rear or side windows with hard objects such as an ice scraper or ring. Doing so may damage the windows.

Chrome-plated exhaust tip*

Regular cleaning and care of chrome-plated exhaust tips will help to maintain their shine and the classy appearance.

- ▶ Use Mercedes-Benz approved Chrome Polishing Paste each time the vehicle has been washed, especially during the winter.

! Do not use alkaline cleaners such as wheel cleaners as they could cause corrosion.

Light alloy wheels

If possible, clean wheels once a week.

- ▶ Use Mercedes-Benz approved Wheel Care, a soft bristle brush and a strong spray of water for cleaning the light alloy wheels.

! Only use acid-free cleaning materials. Acid may cause corrosion or damage the clear coat.

! The vehicle should not be parked for an extended period of time immediately after it has been cleaned, especially not after the wheel rims have been cleaned with wheel rim cleaner.

Wheel rim cleaners can lead to increased corrosion of the brake disks and brake pads. Non-approved wheel cleaners may also damage the wheel paint if the car is not driven after cleaning. Therefore, the vehicle's brake system should always be warmed-up before it is parked after cleaning. To do so, please drive your vehicle for several minutes to allow the brakes to dry.

When applying Mercedes-Benz approved Tire Care and Mercedes-Benz approved Wheel Care products, take care not to spray them on the brake disks.

Plastic and rubber parts

- ▶ Use a gentle dishwashing detergent or mild detergent for delicate fabrics as a washing solution.
- ▶ Wipe with a cloth moistened in a lukewarm solution.

The surface may temporarily change color. If this is the case, wait for it to dry.

Warning!



Do not use cleaners or cockpit care sprays containing solvents to clean the cockpit or the steering wheel. Cleaners containing solvents will make the surface porous and vehicle occupants could suffer serious injuries from plastic parts coming loose in the event of air bag deployment.

! Do not use oil, wax or scouring agents on these parts.

Never apply strong force and only use a soft, non-scratching cloth when cleaning the surface. Do not attempt to wipe the surface with a dry cloth or sponge.

Otherwise you may scratch or damage the surface.

Hard plastic trim items

- ▶ Use Mercedes-Benz approved Interior Care, a soft, lint-free cloth and apply with light pressure.

! Never apply strong force and only use a soft, non-scratching cloth when cleaning the surface. Do not attempt to wipe the surface with a dry cloth or sponge.

Otherwise you may scratch or damage the surface.

Steering wheel and gear selector lever

- ▶ Wipe with a damp cloth and dry thoroughly or clean with Mercedes-Benz approved Leather Care.

Carpets

- ▶ Use Mercedes-Benz approved Carpet and Fabric Care for cleaning the carpets.

Headliner and shelf below rear window

- ▶ Use a soft bristle brush or a dry-shampoo cleaner in case of excessive dirt.

Seat belts

- ▶ Only use clear, lukewarm water and soap.

! The seat belts must not be treated with chemical cleaning agents. Do not dry the seat belts at temperatures above 176 °F (80 °C) or in direct sunlight.

Warning!



Do not bleach or dye seat belts as this may severely weaken them. In a crash they may not be able to provide adequate protection.

Upholstery

Using aftermarket seat covers or wearing clothing that have the tendency to give off coloring (e.g. when wet, etc.) may cause the upholstery to become permanently discolored. By lining the seats with a proper intermediate cover, contact-discoloration will be prevented.

Warning!



Only use seat or head restraint covers which have been tested and approved by Mercedes-Benz for your vehicle model. Using other seat or head restraint covers may interfere with or prevent

- deployment of the head-thorax air bags (CLK cabriolet)
- activation of the active head restraints

Contact an authorized Mercedes-Benz Center for availability.

Leather upholstery

Please note that leather upholstery is a natural product and is therefore subject to a natural aging process. Leather upholstery may also react to certain ambient influences such as high humidity or high temperature by showing wrinkles for example.

- ▶ Wipe leather upholstery with a damp cloth and dry thoroughly or clean with Mercedes-Benz approved Leather Care.

! *Wipe with light pressure to avoid damage to the upholstery.*

Exercise particular care when cleaning perforated leather as its underside should not become wet.

Wood trims

- ▶ Dampen cloth using water and use damp cloth to clean wood trims in your vehicle.

! *Do not use solvents like tar remover or wheel cleaner nor polishes or waxes as these may be abrasive.*



What to do if ...?

Where will I find...?

Unlocking/locking in an emergency

**Opening/closing in an emergency
(Cabriolet)**

Resetting activated head restraints

Replacing SmartKey batteries

Replacing bulbs

Replacing wiper blades

Flat tire

Battery

Jump starting

Towing the vehicle

Fuses

What to do if ...?

Lamps in instrument cluster

General information:

If any of the following lamps in the instrument cluster fails to come on during the

bulb self-check when switching on the ignition, have the respective bulb checked and replaced if necessary.

Problem	Possible cause/consequence	Suggested solution
 <p>The yellow ABS indicator lamp comes on while the engine is running.</p>	<p>The ABS has detected a malfunction and has switched off. The BAS and the ESP® are also switched off (see messages in the multifunction display).</p> <p>The brake system is still functioning normally but without the systems specified above.</p> <p>If the ABS control unit is malfunctioning, other systems such as the navigation system* or the automatic transmission may also be malfunctioning.</p> <p>The charging voltage has fallen below 10 volts. The ABS has switched off. The BAS and the ESP® are also switched off (see messages in the multifunction display)</p> <p>The battery might not be charged sufficiently.</p>	<ul style="list-style-type: none"> ▶ Continue driving with added caution. Wheels will lock during hard braking, reducing steering capability. ▶ Read and observe messages in the multifunction display (▷ page 394). ▶ Have the system checked at an authorized Mercedes-Benz Center as soon as possible. <p>Failure to follow these instructions increases the risk of an accident.</p> <ul style="list-style-type: none"> ▶ Switch off electrical consumers that are currently not needed, e.g. seat heating*. ▶ If necessary, have the generator and battery checked. <p>When the voltage is above this value again, the ABS is operational again.</p>

Problem	Possible cause/consequence	Suggested solution
 <p>The yellow ABS indicator lamp comes on while the engine is running.</p>	<p>The ABS is temporarily not available. The ESP® and the BAS are also unavailable.</p> <p>The system's self-diagnosis may not be completed yet.</p> <p>The brake system is still functioning normally but without the systems specified above.</p>	<ul style="list-style-type: none"> ▶ Drive a short distance with added caution at a vehicle speed of above 12 mph (20 km/h). When the ABS indicator lamp goes out, the ABS, the ESP®, and the BAS are available again. <p>If the ABS indicator lamp does not go out:</p> <ul style="list-style-type: none"> ▶ Continue driving with added caution. ▶ Have the system checked at an authorized Mercedes-Benz Center as soon as possible. <p>Failure to follow these instructions increases the risk of an accident.</p>

What to do if ...?

Problem		Possible cause/consequence	Suggested solution
BRAKE 	(USA only)	The red brake warning lamp comes on while driving and you hear a warning sound.	▶ Release the parking brake (▷ page 53).
	(Canada only)	The red brake warning lamp comes on while driving.	
		There is insufficient brake fluid in the reservoir.	



Warning!



Driving with the brake warning lamp illuminated can result in an accident. Have your brake system checked immediately if the brake warning lamp stays on. Do not add brake fluid before checking the brake system.



Overfilling the brake fluid reservoir can result in spilling brake fluid on hot engine parts and the brake fluid catching fire. You could be seriously burned.

! *If you find that the brake fluid in the brake fluid reservoir has fallen to the minimum mark or below, have the brake system checked for brake pad thickness and leaks.*

Problem		Possible cause/consequence	Suggested solution
 (USA only)  (Canada only)	The yellow engine malfunction indicator lamp comes on while driving.	There is a malfunction in: <ul style="list-style-type: none"> • The fuel management system • The ignition system • The emission control system • Systems which affect emissions Such malfunctions may result in excessive emissions values and may switch the engine to its Limp-Home Mode (emergency operation).	► Have the vehicle checked as soon as possible at an authorized Mercedes-Benz Center. An on-board diagnostic connector is used by the service station to link the vehicle to the shop diagnostics system. It allows the accurate identification of system malfunctions through the readout of diagnostic trouble codes. It is located in the front left area of the footwell next to the parking brake pedal.

i In some states you may be required by law to have the vehicle serviced as soon as the engine malfunction indicator lamp comes on. Check local requirements.

What to do if ...?

Problem	Possible cause/consequence	Suggested solution
 (USA only)  (Canada only) The yellow engine malfunction indicator lamp comes on while driving.	A loss of pressure has been detected in the fuel system. The fuel cap may not be closed properly or the fuel system may be leaky.	<ul style="list-style-type: none"> ▶ Check the fuel cap (▷ page 320). If it is not closed properly: <ul style="list-style-type: none"> ▶ Close the fuel cap. If it is closed properly: <ul style="list-style-type: none"> ▶ Have the fuel system checked at an authorized Mercedes-Benz Center.
 The red coolant warning lamp comes on when the engine is running.	There is insufficient coolant in the reservoir.	<ul style="list-style-type: none"> ▶ Add coolant to prevent engine from overheating (▷ page 328).
	If this warning lamp comes on frequently, there is a leak in the cooling system.	<ul style="list-style-type: none"> ▶ Have the cooling system checked.
	If the coolant level is correct, the electric radiator fan may be broken.	<ul style="list-style-type: none"> ▶ If the coolant temperature is below 248 °F (120 °C), you can continue driving to the nearest authorized Mercedes-Benz Center. ▶ Avoid high engine loads (e.g. driving uphill) and stop-and-go driving.

Problem	Possible cause/consequence	Suggested solution
 <p>The red coolant warning lamp comes on while driving and you hear a warning sound.</p>	<p>The coolant temperature has exceeded 248 °F (120 °C).</p>	<p>► Stop in a safe location as soon as possible and allow the engine and coolant to cool down.</p>

Warning!



Driving when your engine is overheated can cause some fluids which may have leaked into the engine compartment to catch fire. You could be seriously burned.



Steam from an overheated engine can cause serious burns which can occur just by opening the hood. Stay away from the engine if you see or hear steam coming from it.





Turn off the engine, get out of the vehicle and do not stand near the vehicle until the engine has cooled down.

During severe operating conditions, e.g. stop-and-go traffic, the coolant temperature may rise close to 248 °F (120 °C).



! *The engine should not be operated with the coolant temperature above 248 °F (120 °C). Doing so may cause serious engine damage which is not covered by the Mercedes-Benz Limited Warranty.*

What to do if ...?

Problem	Possible cause/consequence	Suggested solution
<p> The yellow ESP® warning lamp comes on while the engine is running.</p>	<p>The ESP® has been switched off with the ESP® switch or has been switched off due to a malfunction.</p> <p>Risk of accident!</p> <p>When the ESP® is switched off it will not stabilize the vehicle if the system recognizes that the vehicle starts to skid or that a wheel is spinning.</p> <p>The cruise control is deactivated and cannot be switched on.</p>	<ul style="list-style-type: none"> ▶ Switch the ESP® back on (▷ page 96). Exceptions: (▷ page 94). ▶ If leaving the ESP® switched off, adapt your speed and driving to the prevailing road, weather and traffic conditions. <p>If the ESP® cannot be switched on:</p> <ul style="list-style-type: none"> ▶ Continue driving with added caution. ▶ Observe additional messages that may appear in the multifunction display (▷ page 394). ▶ Have the system checked at an authorized Mercedes-Benz Center as soon as possible.
<p> The yellow ESP® warning lamp flashes while driving.</p>	<p>The ESP® or traction control has come into operation because of detected traction loss in at least one tire.</p> <p>The cruise control is deactivated</p>	<ul style="list-style-type: none"> ▶ When driving off, apply as little throttle as possible. ▶ While driving, ease up on the accelerator. ▶ Adapt your speed and driving to the prevailing road, weather and traffic conditions. ▶ Do not deactivate the ESP®. Exceptions: (▷ page 94). <p>Failure to follow these instructions increases the risk of an accident.</p>

Problem	Possible cause/consequence	Suggested solution
 The yellow fuel tank reserve warning lamp comes on while driving.	The fuel level has gone below the reserve mark.	<ul style="list-style-type: none"> ▶ Refuel at the next gas station (▷ page 320).
 The yellow roll bar warning lamp comes on or flickers when the engine is running.	The roll bar system is malfunctioning.	<ul style="list-style-type: none"> ▶ Release the roll bars manually. ▶ Have the system checked at an authorized Mercedes-Benz Center as soon as possible.
 The red seat belt telltale comes on for a maximum of 6 seconds after starting the engine.	The seat belt telltale reminds you and your passengers to fasten your seat belts before driving off.	<ul style="list-style-type: none"> ▶ Fasten your seat belts. <p>Regardless of whether the seat belts are fastened or not, the seat belt telltale always comes on and remains lit for 6 seconds after starting the engine.</p>
 You hear a warning chime for a maximum of 6 seconds after starting the engine.	You have forgotten to fasten your seat belt.	<ul style="list-style-type: none"> ▶ Fasten your seat belt. <p>The warning chime stops sounding.</p>

What to do if ...?

Problem	Possible cause/consequence	Suggested solution
 The red seat belt telltale comes on while the vehicle is standing still and the engine is running or during driving.	You and/or your front passenger have forgotten to fasten your seat belts.	<ul style="list-style-type: none"> ▶ Fasten your seat belts. <p>The seat belt telltale goes out.</p>
	There are items placed on the front passenger seat and therefore the system senses the front passenger seat as being occupied.	<ul style="list-style-type: none"> ▶ Remove the items from the front passenger seat and put them in a safe place. <p>The seat belt telltale goes out.</p>
 During driving the red seat belt telltale flashes and you additionally hear an intermittent warning chime with increasing intensity.	The vehicle's speed once exceeded 15 mph (25 km/h) and you and/or your front passenger have forgotten to fasten your seat belts.	<ul style="list-style-type: none"> ▶ Fasten your seat belts. <p>The seat belt telltale goes out and the warning chime stops sounding.</p>
	There are items placed on the front passenger seat and therefore the system senses the front passenger seat as being occupied.	<ul style="list-style-type: none"> ▶ Remove the items from the front passenger seat and put them in a safe place. <p>The seat belt telltale goes out and the warning chime stops sounding.</p>

i After 60 seconds with an unfastened seat belt the warning chime stops sounding and the seat belt telltale illuminates continuously. The seat belt telltale will only go out if both,

the driver's and the front passenger's seat belt are fastened, or the vehicle is standing still and a door is opened.



Problem	Possible cause/consequence	Suggested solution
<p>SRS The red SRS indicator lamp comes on while driving.</p>	<p>There is a malfunction in the supplemental restraint systems. The air bags or Emergency Tensioning Devices (ETDs) could deploy unexpectedly or fail to deploy in an accident.</p>	<p>► Drive with added caution to the nearest authorized Mercedes-Benz Center.</p>

Warning!



In the event a malfunction of the SRS is indicated as outlined above, the SRS may not be operational. For your safety, we strongly recommend that you visit an authorized Mercedes-Benz Center immediately to have the system checked; otherwise the SRS may not be deployed when needed in an accident, which could result in serious or fatal injury, or it might deploy unexpectedly and unnecessarily which could also result in an accident and /or injury to you or to others.

What to do if ...?

Problem	Possible cause/consequence	Suggested solution
 <p>Combination low tire pressure/TPMS malfunction telltale for the TPMS illuminates continuously.</p>	<p>The TPMS detects a loss of pressure in at least one tire.</p>	<ul style="list-style-type: none"> ▶ Carefully bring the vehicle to a halt, avoiding abrupt steering and braking maneuvers. Observe the traffic situation around you. ▶ Read and observe messages in the multifunction display. <p>If the tire inflation pressure in the respective tire(s) has (have) been corrected, the combination low tire pressure/TPMS malfunction telltale goes out after a few minutes of driving.</p>
 <p>Combination low tire pressure/TPMS malfunction telltale for the TPMS flashes 60 seconds and then stays illuminated.</p>	<p>There is a malfunction in the TPMS.</p>	<ul style="list-style-type: none"> ▶ Read and observe messages in the multifunction display. ▶ Have the TPMS checked at an authorized Mercedes-Benz Center. <p>After the malfunction has been remedied the combination low tire pressure/TPMS malfunction telltale goes out after a few minutes of driving.</p>

Warning!

Each tire, including the spare (if provided), should be checked monthly when cold and inflated to the inflation pressure recommended by the vehicle manufacturer on the Tire and Loading Information placard on the driver's door B-pillar (▷ page 334) or, if available, the tire inflation pressure label on the inside of the fuel filler flap (▷ page 320). If your vehicle has tires of a different size than the size indicated on the Tire and Loading Information placard or the tire inflation pressure label, you should determine the proper tire inflation pressure for those tires.

As an added safety feature, your vehicle has been equipped with a tire pressure monitoring system (TPMS) that illuminates a low tire pressure telltale when one or more of your tires is significantly underinflated. Accordingly, when the low tire pressure telltale illuminates, you should stop and check your tires as soon as possible, and inflate them to the proper pressure. Driving on a significantly underinflated tire causes the tire to overheat and can lead to tire failure.

Underinflation also reduces fuel efficiency and tire tread life, and may affect the vehicle's handling and stopping ability. Please note that the TPMS is not a substitute for proper tire maintenance, and it is the driver's responsibility to maintain correct tire pressure, even if underinflation has not reached the level to trigger illumination of the TPMS low tire pressure telltale.

Your vehicle has also been equipped with a TPMS malfunction indicator to indicate when the system is not operating properly. The TPMS malfunction indicator is combined with the low tire pressure telltale. When the system detects a malfunction, the telltale will flash for approximately 1 minute and then remain continuously illuminated. This sequence will continue upon subsequent vehicle start-ups as long as the malfunction exists. When the malfunction indicator is illuminated, the system may not be able to detect or signal low tire pressure as intended.

TPMS malfunctions may occur for a variety of reasons, including the installation of replacement or alternate tires or wheels on the vehicle that prevent the TPMS from functioning properly. Always check the TPMS malfunction telltale after replacing one or more tires or wheels on your vehicle to ensure that the replacement or alternate tires and wheels allow the TPMS to continue to function properly.

What to do if ...?



Lamp in center console

Problem	Possible cause/consequence	Suggested solution
 The front passenger front air bag off indicator lamp illuminates and remains illuminated with the weight of a typical adult or someone larger than a small individual on the front passenger seat.	The system is malfunctioning.	<ul style="list-style-type: none">▶ Have the system checked as soon as possible at an authorized Mercedes-Benz Center.▶ Read and observe messages in the multifunction display and follow corrective steps (▷ page 396).

Warning!





If the  indicator lamp illuminates and remains illuminated with the weight of a typical adult or someone larger than a small individual on the front passenger seat, do not have any passenger use the front passenger seat until the system has been repaired.

Problem	Possible cause/consequence	Suggested solution
  <p>The front passenger front air bag off indicator lamp does not illuminate and/or does not remain illuminated with the weight of a typical 12-month-old child in a standard child restraint or less on the front passenger seat.</p>	<p>The system is malfunctioning.</p>	<ul style="list-style-type: none"> ▶ Make sure there is nothing between seat cushion and child seat and check installation of the child seat. ▶ Make sure no objects applying supplemental weight onto the seat are present. ▶ If the front passenger front air bag off indicator lamp remains out, have the system checked as soon as possible at an authorized Mercedes-Benz Center. Do not transport a child on the front passenger seat until the system has been repaired. ▶ Read and observe messages in the multifunction display and follow corrective steps (▷ page 396).

Warning!



If the   indicator lamp does not illuminate or remains out with the

weight of a typical 12-month-old child in a standard child restraint or less on the front passenger seat, do not transport a child on the front passenger seat until the system has been repaired.

What to do if ...?

Vehicle status messages in the multifunction display





Warning and malfunction messages appear in the multifunction display located in the instrument cluster.





Certain warning and malfunction messages are accompanied by an audible signal.

Address these messages accordingly and follow the additional instructions given in this Operator's Manual.

Selecting the vehicle status message memory menu in the control system (▷ page 154) displays both cleared and uncleared messages.

High-priority messages appear in the multifunction display in red color.

Certain messages of high priority cannot be cleared from the multifunction display using the reset button (▷ page 138) or button , , , or  on the steering wheel.

Other messages of high priority and messages of less immediate priority can be cleared from the multifunction display using the reset button (▷ page 138) or button , , , or  on the steering wheel. They are then stored in the vehicle status message memory (▷ page 154). Remember that clearing a message will only make the message disappear. Clearing a message will not correct the condition that caused the message to appear.

Warning!



All categories of messages contain important information which should be taken note of and, where a malfunction is indicated, addressed as soon as possible at an authorized Mercedes-Benz Center.

Failure to repair condition noted may cause damage not covered by the Mercedes-Benz Limited Warranty, or result in property damage or personal injury.

Warning!

No messages will be displayed if either the instrument cluster or the multifunction display is inoperative.

As a result, you will not be able to see information about your driving conditions, such as speed or outside temperature, warning/indicator lamps, malfunction/warning messages or the failure of any systems. Driving characteristics may be impaired.

If you must continue to drive, please do so with added caution. Visit an authorized Mercedes-Benz Center as soon as possible.

i *Switching on the ignition causes all instrument cluster lamps (except low beam headlamp indicator lamp, high beam headlamp indicator lamp, and turn signal indicator lamps unless activated) as well as the multifunction display to come on. Make sure the lamps and the multifunction display are in working order before starting your journey.*

On the pages that follow, you will find a compilation of the most important warning and malfunction messages that may appear in the display.

High priority messages appear in red color.

For your convenience the messages are divided into two sections:

- Text messages (▷ page 394)
- Symbol messages (▷ page 403)

What to do if ...?







Text messages

Display message	Possible cause/consequence	Possible solution
<p>ABS</p> <p>ABS, ESP Unavailable See Operator's Man.</p>	<p>The ABS and ESP® are not available due to a malfunction.</p> <p>The BAS is also deactivated.</p> <p>The brake system is still functioning normally but without but without the systems specified above.</p>	<ul style="list-style-type: none"> ▶ Continue driving with added caution. Wheels will lock during hard braking, reducing steering capability. ▶ Have the system checked at an authorized Mercedes-Benz Center as soon as possible. <p>Failure to follow these instructions increases the risk of an accident.</p>
<p>Cruise Control And SPEEDTRONIC</p> <p>Inoperative</p>	<p>Cruise control is malfunctioning.</p>	<p>Have the cruise control checked at an authorized Mercedes-Benz Center.</p>
<p>ESP</p> <p>Inoperative See Operator's Manual</p>	<p>The ESP® has switched off due to a malfunction.</p> <p>The ABS and the BAS might not be operational.</p> <p>The brake system is still functioning normally but without the systems specified above.</p>	<ul style="list-style-type: none"> ▶ Continue driving with added caution. ▶ Contact an authorized Mercedes-Benz Center as soon as possible. <p>Failure to follow these instructions increases the risk of an accident.</p>

Display message	Possible cause/consequence	Possible solution
<p>ESP Unavailable See Operator's Manual</p>	<p>The ESP® is temporarily not available. The system's self-diagnosis may not be completed yet. The ABS and the BAS might not be operational. The brake system is still functioning normally but without the systems specified above.</p> <p>The charging voltage has fallen below 10 volts. The ESP® has switched off. The BAS may be switched off, too. The battery may not be charged. The battery or the generator may be malfunctioning. The ABS might not be operational. The brake system is still functioning normally but without the systems specified above.</p>	<p>► Drive a short distance with added caution at a vehicle speed of above 12 mph (20 km/h). When the message disappears, the ESP® is available again.</p> <p>If the message does not disappear:</p> <p>► Continue driving with added caution. ► Have the system checked at an authorized Mercedes-Benz Center as soon as possible.</p> <p>Failure to follow these instructions increases the risk of an accident.</p> <p>► Continue driving with added caution. When the voltage is above this value again, the ESP® is operational again. ► Have the system checked at an authorized Mercedes-Benz Center as soon as possible.</p>



What to do if ...?

Display message	Possible cause/consequence	Possible solution
Front Passenger Airbag Enabled See Operator's Manual	Front passenger front air bag is activated while driving even though a child, small individual, or object below the system's weight threshold is on the front passenger seat, or the front passenger seat is empty. Objects on the seat or forces acting on the seat may make the system sense supplemental weight.	Stop the vehicle in a safe location as soon as possible and check the front passenger seat for the following: <ul style="list-style-type: none">▶ Switch off the ignition (▷ page 38).▶ Remove child and child restraint from front passenger seat and properly secure the child in rear seat employing the child restraint if necessary.▶ Make sure no objects applying supplemental weight onto the seat are present. The system may recognize such supplemental weight and sense that an occupant on the front passenger seat is of a greater weight than actually present.▶ Keep the seat unoccupied, close the front passenger door and switch on the ignition (▷ page 38). (Continued on next page)

Display message	Possible cause/ consequence	Possible solution
		<p>Monitor the   indicator lamp on the center console (▷ page 31) and the multifunction display in the instrument cluster (▷ page 28) for the following:</p> <p>With the seat unoccupied and the ignition turned on,</p> <ul style="list-style-type: none"> the   indicator lamp on the center console should illuminate and remain illuminated, indicating that the OCS (▷ page 72) has deactivated the air bag. the message Front Passenger Airbag Enabled See Operator's Manual or the message Front Passenger Airbag Disabled See Operator's Manual should not appear in the multifunction display at any time the seat is unoccupied. Wait at least 60 seconds for the system to complete the necessary check cycles and to make sure neither message appears in the multifunction display. <p>If above conditions are met, you can occupy the front passenger seat again. Depending on the front passenger classification sensed by the OCS (▷ page 72), the   indicator lamp will remain illuminated or go out.</p> <p>If above conditions are not met, the system is not working properly. Have the system checked as soon as possible at an authorized Mercedes-Benz Center.</p>

Warning!





If the   indicator lamp remains

out even after performing the above corrective steps, do not have any children 12 years old and under and other small individuals

use the front passenger seat until the system has been repaired.

What to do if ...?

Display message	Possible cause/consequence	Possible solution
Front Passenger Airbag Disabled See Operator's Manual	Front passenger front air bag is deactivated while driving even though an adult or someone larger than a small individual is occupying the front passenger seat. Forces acting on the seat may make the system sense a decrease in weight.	Stop the vehicle in a safe location as soon as possible and check the front passenger seat for the following: <ul style="list-style-type: none">▶ Switch off the ignition (▷ page 38).▶ Have the front passenger vacate the seat and exit the vehicle.▶ Keep the seat unoccupied, close the front passenger door and switch on the ignition (▷ page 38). (Continued on next page)

Display message	Possible cause/ consequence	Possible solution
		<p>Monitor the  PASS AIR BAG OFF indicator lamp on the center console (▷ page 31) and the multifunction display in the instrument cluster (▷ page 28) for the following:</p> <p>With the seat unoccupied and the ignition turned on,</p> <ul style="list-style-type: none"> the  PASS AIR BAG OFF indicator lamp on the center console should illuminate and remain illuminated, indicating that the OCS (▷ page 72) has deactivated the air bag. the message Front Passenger Airbag Enabled See Operator's Manual or the message Front Passenger Airbag Disabled See Operator's Manual should not appear in the multifunction display at any time the seat is unoccupied. Wait at least 60 seconds for the system to complete the necessary check cycles and to make sure neither message appears in the multifunction display. <p>If above conditions are met, you can occupy the front passenger seat again. Depending on the front passenger classification sensed by the OCS (▷ page 72), the  PASS AIR BAG OFF indicator lamp will remain illuminated or go out.</p> <p>If above conditions are not met, the system is not working properly. Have the system checked as soon as possible at an authorized Mercedes-Benz Center.</p>

Warning!



If the  **PASS AIR BAG OFF** indicator lamp remains

illuminated with an adult occupant on the front passenger seat even after performing the above corrective steps, do not have any

passenger use the front passenger seat until the system has been repaired.

What to do if ...?

Display message	Possible cause/consequence	Possible solution
<p>P</p> <p>Selector Lever In Park</p>	<p>You have turned off the engine with the KEYLESS-GO* start/stop button in gear selector lever position N and opened the driver's door.</p> <p>or</p> <p>You have attempted to switch off the engine with the KEYLESS-GO* start/stop button while the gear selector lever was in position R or D.</p>	<p>▶ Place the gear selector lever in position P.</p>
<p>Please Shift To N or P</p>	<p>You have attempted to start the engine with the KEYLESS-GO* start/stop button while the gear selector lever was in position R or D.</p>	<p>▶ Place the gear selector lever in position P or N.</p>
<p>Run Flat Indicator Inoperative</p>	<p>Run Flat Indicator is malfunctioning.</p>	<p>▶ Have the Run Flat Indicator checked at an authorized Mercedes-Benz Center.</p>
<p>Check tires, then restart Run Flat Indicator.</p>	<p>There was a warning message about a loss in the tire inflation pressure and the Run Flat Indicator has not been reactivated yet.</p>	<p>▶ Make sure the correct tire inflation pressure is set for each tire.</p> <p>▶ Then restart the Run Flat Indicator.</p>

Display message	Possible cause/consequence	Possible solution
Tire Pressure Check Tires	The Run Flat Indicator indicates that the pressure is too low in one or more tires.	<ul style="list-style-type: none"> ▶ Carefully bring the vehicle to a halt, avoiding abrupt steering and braking maneuvers. Observe the traffic situation around you. ▶ Check and adjust tire inflation pressure as required (▷ page 341). ▶ If necessary, change the wheel (▷ page 452). ▶ Restart the Run Flat Indicator after adjusting the tire inflation pressure values (▷ page 343).
Tire Pressure Monitor Inoperative	The TPMS is malfunctioning.	<ul style="list-style-type: none"> ▶ Have the TPMS checked at an authorized Mercedes-Benz Center.
Tire Pressure Monitor Inoperative No Wheel Sensors	There are wheels without appropriate wheel sensors mounted (e.g. winter tires).	<ul style="list-style-type: none"> ▶ Have the TPMS checked at an authorized Mercedes-Benz Center. ▶ Have the wheel sensors installed at an authorized Mercedes-Benz Center.
Tire Pressure Monitor Currently Unavailable	The TPMS is unable to monitor the tire pressure due to a nearby radio interference source.	As soon as the causes of the malfunction have been removed, the TPMS automatically becomes active again after a few minutes of driving.

What to do if ...?

Warning!



Do not drive with a flat tire. A flat tire affects the ability to steer or brake the vehicle. You may lose control of the vehicle. Continued driving with a flat tire will cause excessive heat build-up and possibly a fire.

Warning!



Follow recommended tire inflation pressures.





Do not underinflate tires. Underinflated tires wear excessively and/or unevenly, adversely affect handling and fuel economy, and are more likely to fail from being overheated.

Do not overinflate tires. Overinflated tires can adversely affect handling and ride comfort, wear unevenly, increase stopping distance, and result in sudden deflation (blowout) because they are more likely to become punctured or damaged by road debris, potholes etc.

Symbol messages

Display symbol	Display message	Possible cause/consequence	Possible solution
		<p>The battery is no longer charging. Possible causes:</p> <ul style="list-style-type: none"> • broken poly-V-belt • alternator malfunctioning 	<p>▶ Stop immediately in a safe location or as soon as it is safe to do so and check the poly-V-belt.</p> <p>If it is broken:</p> <ul style="list-style-type: none"> ▶ Do not continue to drive. Otherwise the engine will overheat due to an inoperative water pump which may result in damage to the engine. Notify an authorized Mercedes-Benz Center. <p>If it is intact:</p> <ul style="list-style-type: none"> ▶ Drive immediately to the nearest authorized Mercedes-Benz Center.
	Low Voltage Charge Battery	The battery has insufficient voltage.	▶ Start the engine (▷ page 51).
	Low Voltage Switch Off Consumers	The battery has insufficient voltage.	▶ Turn off unnecessary electrical consumers.

What to do if ...?

Display symbol	Display message	Possible cause/consequence	Possible solution
	Brake Wear	The brake pads have reached their wear limit.	▶ Have the brake pads replaced as soon as possible.
 (USA only)  (Canada only)	Release Parking Brake	You are driving with the parking brake set.	▶ Release the parking brake (▷ page 53).
 (USA only)  (Canada only)	Check Brake Fluid Level	There is insufficient brake fluid in the reservoir.	▶ Risk of accident! Stop the vehicle in a safe location or as soon as it is safe to do so and notify an authorized Mercedes-Benz Center. Do not add brake fluid! This will not solve the problem.



Warning!



Driving with the message **Check Brake Fluid Level** displayed can result in an accident. Have your brake system checked immediately. Do not add brake fluid before checking the brake system. Overfilling the brake fluid reservoir can result in spilling brake fluid on hot engine parts and the brake fluid catching fire. You could be seriously burned.

! If you find that the brake fluid in the brake fluid reservoir has fallen to the minimum mark or below, have the brake system checked for brake pad thickness and leaks.

! Brake pad thickness must be visually checked by a qualified technician at the intervals specified in the Maintenance Booklet.

Display symbol	Display message	Possible cause/consequence	Possible solution
	Visit workshop	There may be a malfunction in the <ul style="list-style-type: none"> • fuel injection system • ignition system • exhaust system • fuel system 	▶ Have the measuring system checked at an authorized Mercedes-Benz Center.
	Top Up Coolant See Operator's Man.	The coolant level is too low.	▶ Add coolant (▷ page 328). ▶ If you have to add coolant frequently, have the cooling system checked at an authorized Mercedes-Benz Center.

Warning!





Do not spill antifreeze on hot engine parts. Antifreeze contains ethylene glycol which may burn if it comes into contact with hot engine parts. You could be seriously burned.

! Do not ignore the low engine coolant level warning. Extended driving with the message and symbol displayed may cause serious engine damage not covered by the Mercedes-Benz Limited Warranty.

Do not drive without sufficient amount of coolant in the cooling system. The engine will overheat, causing major engine damage.

What to do if ...?

Display symbol	Display message	Possible cause/consequence	Possible solution
	Coolant Stop vehicle, turn engine off.	The coolant is too hot. Among other possible causes, the poly-V-belt could be broken.	<ul style="list-style-type: none"> ▶ Stop the vehicle in a safe location or as soon as it is safe to do so. ▶ Apply the parking brake (▷ page 59). ▶ Turn off the engine. ▶ Check the poly-V-belt. <p>If it is broken:</p> <ul style="list-style-type: none"> ▶ Do not continue to drive. Otherwise the engine will overheat due to an inoperative water pump which may result in damage to the engine. Contact an authorized Mercedes-Benz Center. <p>If it is intact:</p> <ul style="list-style-type: none"> ▶ Wait for the message to disappear before restarting the engine. <p>Doing otherwise could result in serious engine damage that is not covered by the Mercedes-Benz Limited Warranty.</p> <p>(Continued on next page)</p>

Display symbol	Display message	Possible cause/consequence	Possible solution
			<ul style="list-style-type: none"> ▶ Observe the coolant temperature indicator in the instrument cluster (▷ page 28). If the temperature rises again: <ul style="list-style-type: none"> ▶ Contact an authorized Mercedes-Benz Center immediately.
		The cooling fan for the coolant is malfunctioning.	<ul style="list-style-type: none"> ▶ Observe the coolant temperature indicator in the instrument cluster (▷ page 28). ▶ Have the fan replaced as soon as possible.

Warning!



Driving when your engine is overheated can cause some fluids which may have leaked into the engine compartment to catch fire. You could be seriously burned.



Steam from an overheated engine can cause serious burns which can occur just by opening the hood. Stay away from the engine if you see or hear steam coming from it.

Turn off the engine, get out of the vehicle and do not stand near the vehicle until the engine has cooled down.

During severe operating conditions and stop-and-go city traffic, the coolant temperature may rise close to 248°F (120°C).

! *The engine should not be operated with the coolant temperature above 248°F (120°C). Doing so may cause serious engine damage which is not covered by the Mercedes-Benz Limited Warranty.*

What to do if ...?

Display symbol	Display message	Possible cause/consequence	Possible solution
	Gas Cap Is Open	A loss of pressure has been detected in the fuel system. The fuel cap may not be closed properly or the fuel system may be leaky.	<ul style="list-style-type: none"> ▶ Check the fuel cap (▷ page 320). If it is not closed properly: <ul style="list-style-type: none"> ▶ Close the fuel cap. If it is closed properly: <ul style="list-style-type: none"> ▶ Have the fuel system checked at an authorized Mercedes-Benz Center.
	Reserve Fuel	The fuel level has dropped below the reserve mark.	Refuel at the next gas station (▷ page 320).
	Display Malfunction Service Required	Certain electronic systems are unable to relay information to the control system. The following systems may have failed: <ul style="list-style-type: none"> • Coolant temperature display • Tachometer • Cruise control display 	<ul style="list-style-type: none"> ▶ Have the electronic systems checked at an authorized Mercedes-Benz Center.

Display symbol	Display message	Possible cause/consequence	Possible solution
	Check oil level at next refueling.	The engine oil level has dropped to a critical level.	<ul style="list-style-type: none"> ▶ Check the engine oil level (▷ page 325) and add oil as required (▷ page 327). ▶ If you must add engine oil frequently, have the engine checked for possible leaks.

When the message `Check oil level at next refueling.` appears while the engine is running and at operating temperature, the engine oil level has dropped to approximately the minimum level.

When this occurs, the warning is at first intermittent and then remains on if the oil level drops further.



Visually check for oil leaks. If there are no obvious oil leaks, drive to the nearest service station to refill the engine oil to the required level.

For information on approved engine oils, refer to the Factory Approved Service Products pamphlet (USA only) or contact an authorized Mercedes-Benz Center.

! *Engine oil level warnings should not be ignored. Extended driving with the symbol displayed could result in serious engine damage that is not covered by the Mercedes-Benz Limited Warranty.*

What to do if ...?

Display symbol	Display message	Possible cause/consequence	Possible solution
	Change Key Batteries	The SmartKey with KEYLESS-GO* batteries are discharged.	▶ Change the batteries (▷ page 441).
	Key Detected In Vehicle	A SmartKey with KEYLESS-GO* left in the vehicle was recognized while locking the vehicle from the outside.	▶ Take the SmartKey out of the vehicle.
	Key Not Detected	The SmartKey with KEYLESS-GO* is momentarily not recognized.	▶ Change the position of the SmartKey in the vehicle. ▶ Operate the vehicle with the SmartKey in the starter switch if necessary.
	Key Not Detected	The SmartKey with KEYLESS-GO* is not recognized while the engine is running because <ul style="list-style-type: none"> • the SmartKey is not in the vehicle • there is strong radio-frequency interference 	▶ Stop the vehicle as soon as it is safe to do so. ▶ Apply the parking brake (▷ page 59). ▶ Search for the SmartKey. Otherwise the vehicle cannot be centrally locked nor can the engine be started again after the engine has been stopped.
	Please get a new key.	No additional code available for SmartKey or SmartKey with KEYLESS-GO*	▶ Contact an authorized Mercedes-Benz Center as soon as possible.

Display symbol	Display message	Possible cause/consequence	Possible solution
	Please don't forget your key	This display appears (for a maximum of 60 seconds) if the driver's door is opened with the engine shut off and no SmartKey in the starter switch. Message is only a reminder.	<ul style="list-style-type: none"> ▶ Insert SmartKey in the starter switch. ▶ Take the SmartKey with KEYLESS-GO* with you when leaving the vehicle.
	Remove Key	You have forgotten to remove the SmartKey.	▶ Remove the SmartKey from the starter switch.
	Active Headlamps Auxiliary Bulb On	The active headlamps are malfunctioning. Another light is being used.	▶ Contact an authorized Mercedes-Benz Center as soon as possible.
	Active Headlamps Inoperative	The Bi-Xenon cornering lamps system is malfunctioning.	▶ Contact an authorized Mercedes-Benz Center as soon as possible.
	AUTO-Light Inoperative	The light sensor is malfunctioning. The headlamps switch on automatically.	<ul style="list-style-type: none"> ▶ Contact an authorized Mercedes-Benz Center as soon as possible. <p>To switch off the headlamps:</p> <ul style="list-style-type: none"> ▶ In the control system, set lamp operation to manual mode (▷ page 162). ▶ Switch off the headlamps using the exterior lamp switch (▷ page 129).
	3rd Brake Lamp	The high mounted brake lamp is malfunctioning. This message will only appear if a critical number of LEDs have stopped working.	▶ Contact an authorized Mercedes-Benz Center as soon as possible.

What to do if ...?

Display symbol	Display message	Possible cause/consequence	Possible solution
	Brake Lamp Left	The left brake lamp is malfunctioning.	▶ Replace the bulb as soon as possible (▷ page 448).
	Brake Lamp Right	The right brake lamp is malfunctioning.	▶ Replace the bulb as soon as possible (▷ page 448).
	Front Foglamp Left	The left front fog lamp is malfunctioning.	▶ Contact an authorized Mercedes-Benz Center as soon as possible.
	Front Foglamp Right	The right front fog lamp is malfunctioning.	▶ Contact an authorized Mercedes-Benz Center as soon as possible.
	Front Left Parking Lamp	The left front parking lamp is malfunctioning.	▶ Replace the bulb as soon as possible (▷ page 447).
	Front Right Parking Lamp	The right front parking lamp is malfunctioning.	▶ Replace the bulb as soon as possible (▷ page 447).
	Front Left Turn Signal	The left front turn signal lamp is malfunctioning.	▶ Replace the bulb as soon as possible (▷ page 447).
	Front Right Turn Signal	The right front turn signal lamp is malfunctioning.	▶ Replace the bulb as soon as possible (▷ page 447).
	High Beam Left	The left high beam lamp is malfunctioning.	▶ Replace the bulb as soon as possible (▷ page 446).
	High Beam Right	The right high beam lamp is malfunctioning.	▶ Replace the bulb as soon as possible (▷ page 446).

Display symbol	Display message	Possible cause/consequence	Possible solution
	License Plate Lamp Left	The left license plate lamp is malfunctioning.	▶ Replace the bulb as soon as possible (▷ page 449).
	License Plate Lamp Right	The right license plate lamp is malfunctioning.	▶ Replace the bulb as soon as possible (▷ page 449).
	Low Beam Left	The left low beam lamp is malfunctioning.	Halogen headlamp: ▶ Replace the bulb as soon as possible (▷ page 446). Bi-Xenon* headlamp: ▶ Contact an authorized Mercedes-Benz Center as soon as possible.
	Low Beam Right	The right low beam lamp is malfunctioning.	Halogen headlamp: ▶ Replace the bulb as soon as possible (▷ page 446). Bi-Xenon* headlamp: ▶ Contact an authorized Mercedes-Benz Center as soon as possible.
	Marker Lamp Front Left	The front left side marker lamp is malfunctioning.	▶ Contact an authorized Mercedes-Benz Center as soon as possible.
	Marker Lamp Front Right	The front right side marker lamp is malfunctioning.	▶ Contact an authorized Mercedes-Benz Center as soon as possible.

What to do if ...?

Display symbol	Display message	Possible cause/consequence	Possible solution
	Rear Foglamp Auxiliary Bulb On	The foglamp is malfunctioning. A backup bulb is being used.	▶ Replace the bulb as soon as possible (▷ page 448).
	Reverse Lamp Left	The left backup lamp is malfunctioning.	▶ Replace the bulb as soon as possible (▷ page 448).
	Reverse Lamp Right	The right backup lamp is malfunctioning.	▶ Replace the bulb as soon as possible (▷ page 448).
	Switch Off Lights	You have removed the SmartKey from the starter switch, opened the driver's door and left the headlamps on or removed the SmartKey with KEYLESS-GO* from the vehicle and left the headlamps on.	▶ Switch off the headlamps.
	Switch Off Lights Or Remove Key	The exterior lamp switch is in position AUTO , and the SmartKey or SmartKey with KEYLESS-GO* is in the starter switch. The parking lamps remains on.	▶ Remove SmartKey or SmartKey with KEYLESS-GO* from starter switch. or ▶ Turn the exterior lamp switch to position 0 .
	Tail Lamp Left Auxiliary Bulb On	The left tail lamp is malfunctioning. A backup bulb is being used.	▶ Replace the bulb as soon as possible (▷ page 448).

Display symbol	Display message	Possible cause/consequence	Possible solution
	Tail Lamp Right Auxiliary Bulb On	The right tail lamp is malfunctioning. A backup bulb is being used.	► Replace the bulb as soon as possible (▷ page 448).
	Left Mirror Turn Signal	The turn signal in the left exterior rear view mirror is malfunctioning. This message will only appear if a critical number of LEDs have stopped working.	► Contact an authorized Mercedes-Benz Center as soon as possible.
	Right Mirror Turn Signal	The turn signal in the right exterior rear view mirror is malfunctioning. This message will only appear if a critical number of LEDs have stopped working.	► Contact an authorized Mercedes-Benz Center as soon as possible.
	Turn Signal Rear Left Auxiliary Bulb On	The left rear turn signal lamp is malfunctioning. A backup bulb is being used.	► Replace the bulb as soon as possible (▷ page 448).
	Turn Signal Rear Right Auxiliary Bulb On	The right rear turn signal lamp is malfunctioning. A backup bulb is being used.	► Replace the bulb as soon as possible (▷ page 448).

What to do if ...?



Display symbol	Display message	Possible cause/consequence	Possible solution
SRS	Restraint System Malfunction Service Required	The system is malfunctioning.	► Drive with added caution to the nearest authorized Mercedes-Benz Center.

Warning!



In the event a malfunction of the SRS is indicated as outlined above, the SRS may not be operational.

For your safety, we strongly recommend that you visit an authorized Mercedes-Benz Center immediately to have the system checked; otherwise the SRS may not be deploy when needed in an accident, which could result in serious or fatal injury, or it might deploy unexpectedly and unnecessarily which could also result in injury.

Display symbol	Display message	Possible cause/consequence	Possible solution
	Please Engage Roll-over Bar	The roll bars are malfunctioning.	▶ Have the system checked at an authorized Mercedes-Benz Center as soon as possible.
	Please Release Roll-over Bar	The roll bars are malfunctioning.	▶ Operate the roll bars manually (▷ page 430). ▶ Have the system checked at an authorized Mercedes-Benz Center as soon as possible.
	Steering oil Service Required	The steering gear oil level is too low. There is a danger of steering gear damage.	▶ Have the system checked at an authorized Mercedes-Benz Center.

Warning!









If the level of steering gear oil in reservoir is too low, the steering power assistance could fail. Much greater effort will then be needed to turn the steering wheel.

Do not add steering oil without checking the steering system.

Do not drive the vehicle. Have the system checked at an authorized Mercedes-Benz Center as soon as possible.

What to do if ...?

Display symbol	Display message	Possible cause/consequence	Possible solution
	Skibag Open	This message will appear when the soft top is operated with the ski bag roller blind in its upward position.	▶ Pull the ski bag roller blind downward and secure it (▷ page 280).
	Tele Aid Inoperative	One or more main functions of the Tele Aid system are malfunctioning.	▶ Have the Tele Aid system checked at an authorized Mercedes-Benz Center.
	Function Unavailable	This display appears if button  or  on the multifunction steering wheel is pressed and the vehicle is not equipped with a telephone.	

Display symbol	Display messages	Possible cause/consequence	Possible solution
	Please correct the tire pressure.	The tire pressure is too low in one or more tires.	▶ Check and correct tire inflation pressure as required (▷ page 344).
	Tire Pressure Caution Tire Defect	One or more tires are deflating.	▶ Carefully bring the vehicle to a halt, avoiding abrupt steering and braking maneuvers. ▶ If necessary, change the wheel (▷ page 452).
	Tire Pressure Check Tires	The tire pressure in one or more tires is already below the minimum value.	▶ Carefully bring the vehicle to a halt, avoiding abrupt steering and braking maneuvers. ▶ Check and adjust tire pressure as required (▷ page 344). ▶ If necessary, change the wheel (▷ page 452).

Warning!



Do not drive with a flat tire. A flat tire affects the ability to steer or brake the vehicle. You may lose control of the vehicle. Continued driving with a flat tire will cause excessive heat build-up and possibly a fire.

Warning!





Follow recommended tire inflation pressures.

Do not underinflate tires. Underinflated tires wear excessively and/or unevenly, adversely affect handling and fuel economy, and are more likely to fail from being overheated.

Do not overinflate tires. Overinflated tires can adversely affect handling and ride comfort, wear unevenly, increase stopping distance, and result in sudden deflation (blowout) because they are more likely to become punctured or damaged by road debris, potholes etc.

What to do if ...?

Display symbol	Display message	Possible cause/consequence	Possible solution
	Open/Close Top Completely	The soft top is not properly locked.	▶ Lock the soft top again (▷ page 262).
	Top Lowering	The soft top is not completely open or closed. The hydraulics are losing pressure.	▶ Open or close the soft top all the way.
	Top Operation Only At Standstill	You have attempted to open or close the soft top while driving.	▶ Pull over to the side of the road and repeat soft top operation while the vehicle is stationary.
	Trunk Partition Open	This message will appear when the soft top is operated with the luggage cover folded back.	▶ Pull out and latch the luggage cover (▷ page 264).
	Top Up Washer Fluid	The fluid level has dropped to about $\frac{1}{3}$ of total reservoir capacity.	▶ Add washer fluid (▷ page 330).

▼ Where will I find...?

First aid kit

The first aid kit is located in the trunk on the left side (CLK coupe) or on the right side (CLK cabriolet), secured by a hook and loop fastener.



Example CLK coupe

- ▶ Loosen hook and loop fastener.
- ▶ Remove first aid kit.

i Check expiration dates and contents for completeness at least once a year and replace missing/expired items.

Storage compartment underneath the trunk floor

The TIREFIT kit (CLK 63 AMG only) or the vehicle tool and the Minispare wheel are located under the trunk floor.

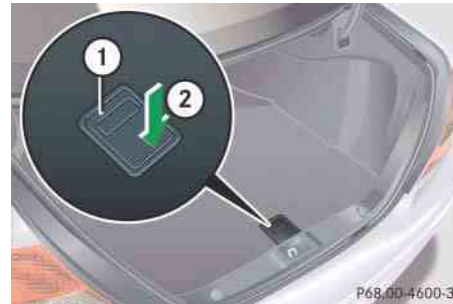

- ① Handle
- ② Push handle
- ▶ **Raising:** Push in handle ① in direction of arrow ②. The other side of handle ① lifts up.
- ▶ Take handle ① and lift up the trunk floor cover.



- ① Handle
- ③ Upper trunk lip
- ▶ Engage handle ① on upper trunk lip ③.

You can now access the TIREFIT kit (CLK 63 AMG only) or the vehicle tool kit and Minispare wheel.

! To prevent damage, always disengage handle ① from upper trunk lip ③ and lower trunk floor cover before closing the trunk.

- ▶ **Lowering:** To disengage handle ① lift up the trunk floor.
- ▶ Disengage handle ① from upper trunk lip ③ and lower the trunk floor cover.

Where will I find...?

TIREFIT (CLK 63 AMG only)

The TIREFIT kit is located under the trunk floor.

- ▶ Lift up trunk floor cover and engage the handle in the upper edge of trunk (▷ page 421).

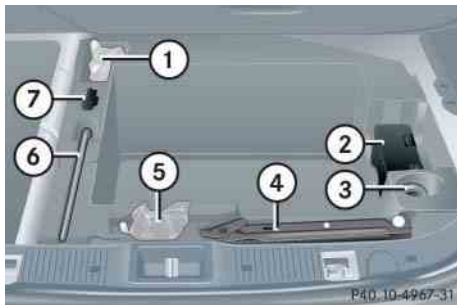

- ① Straps for soft top emergency operation, a pair of gloves
- ② Electric air pump
- ③ Towing eye bolt
- ④ Vehicle jack
- ⑤ TIREFIT kit
- ⑥ Wheel wrench
- ⑦ Collapsible wheel chock

Vehicle tool kit

The vehicle tool kit is located in the storage compartment underneath the trunk floor.

The following is included:

- Towing eye bolt
- Wheel wrench
- Alignment bolt
- Vehicle jack
- Collapsible wheel chock
- A pair of gloves
- Straps for soft top emergency operation (CLK cabriolet only)

The spare wheel bolts are fixed at the Minispare wheel.

i (CLK cabriolet) Hex wrench:
You will find the hex wrench for manually operating the roll bars (▷ page 430) or the soft top (▷ page 432) at the lower edge of the storage well casing.

Removing the vehicle tool kit

- ▶ Lift up trunk floor cover and engage the handle in upper edge of trunk (▷ page 421).



Example CLK coupe

- ① Retaining screw
 - ② Storage well casing
- ▶ Loosen retaining screw ① in the middle of storage well casing ② by turning it counterclockwise.
 - ▶ Remove storage well casing ②.

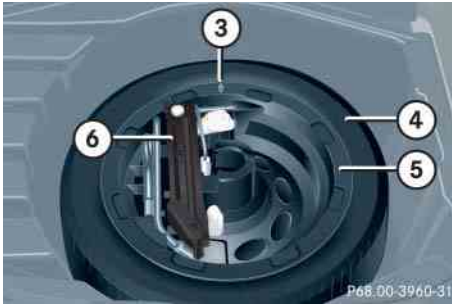

Example CLK coupe

- ③ Arrow
- ④ Minispare wheel
- ⑤ Vehicle tool kit storage well casing
- ⑥ Vehicle tool kit
- ▶ Remove vehicle tool kit ⑥.

Storing the vehicle tool kit

- ▶ Place vehicle tool kit ⑥ in vehicle tool kit storage well casing ⑤.
- ▶ Place storage well casing ② over the vehicle tool kit storage well casing ⑤ and turn retaining screw ① clockwise as far it will go to secure the Minispare wheel.

i Arrow ③ on vehicle tool kit storage well casing ⑤ must point in the direction of travel. Otherwise you cannot place the storage well casing ② on top and secure the Minispare wheel with retaining screw ①.

- ▶ Disengage the handle in upper edge of trunk and lower trunk floor cover (▷ page 421).

! To prevent damage, always disengage trunk floor handle from upper edge of trunk and lower trunk floor before closing the trunk.

Vehicle jack

Warning!



The jack is designed exclusively for jacking up the vehicle at the jack take-up brackets built into both sides of the vehicle. To help avoid personal injury, use the jack only to lift the vehicle during a wheel change. Never get beneath the vehicle while it is supported by the jack. Keep hands and feet away from the area under the lifted vehicle. Always firmly set parking brake and block wheels before raising vehicle with jack.

Do not disengage parking brake while the vehicle is raised. Be certain that the jack is always vertical (plumb line) when in use, especially on hills. Always try to use the jack on level surface. Make sure the jack arm is fully seated in the jack take-up bracket. Always lower the vehicle onto sufficient capacity jackstands before working under the vehicle.

Where will I find...?

The vehicle jack is located in the storage compartment underneath the trunk floor.

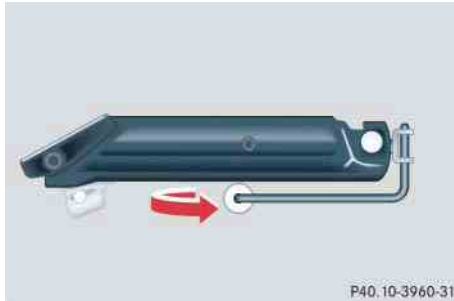

Storage position

- ▶ Remove vehicle jack from its compartment.
- ▶ Turn crank handle in direction of arrow as far as it will go.

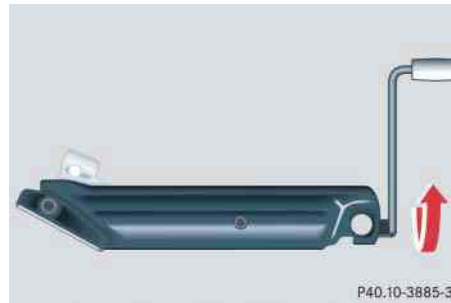

Operational position

- ▶ Turn crank handle clockwise.

Before storing the vehicle jack in its compartment:

- It should be fully collapsed.
- The handle must be folded in (storage position).

Setting up the collapsible wheel chock

The collapsible wheel chock serves to additionally secure the vehicle, e.g. while changing the wheel.

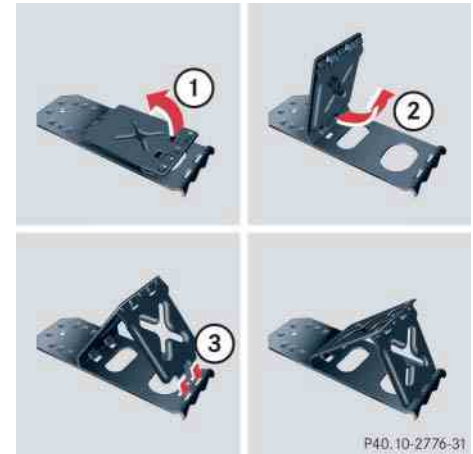

- ① Tilt the plate upward
- ② Fold the lower plate outward
- ③ Insert the plate

- ▶ Tilt both plates upward ①.
- ▶ Fold the lower plate outward ②.
- ▶ Guide the tabs of the lower plate all the way into the openings of the base plate ③.

For information on where to place wheel chocks when changing a wheel, see “Lifting the vehicle” (▷ page 459).

Minispare wheel

The Minispare wheel is located in the storage compartment underneath the trunk floor.

Removing the Minispare wheel

- ▶ Lift up trunk floor cover and engage trunk floor handle in upper edge of trunk.
- ▶ Loosen the retaining screw in the middle of storage well casing by turning it counterclockwise (▷ page 422).
- ▶ Remove the storage well casing (▷ page 422).

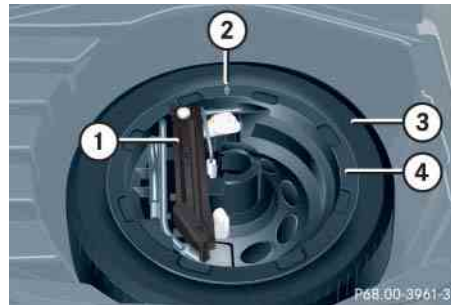

Example CLK coupe

- ① Vehicle tool kit
Wheel wrench
Jack
 - ② Arrow
 - ③ Minispare wheel, Wheel bolts for
Minispare wheel
 - ④ Vehicle tool kit storage well casing
- ▶ Remove vehicle tool kit storage well casing ④.
 - ▶ Remove Minispare wheel ③.

Storing the Minispare wheel

- ▶ Place Minispare wheel ③ in wheel well.
- ▶ Place vehicle tool kit storage well casing ④ over the Minispare wheel.

Make sure arrow ② on vehicle tool kit storage well casing ④ points in the direction of travel.
- ▶ Place storage well casing (▷ page 422) over vehicle tool kit storage well casing ④ and turn the retaining screw (▷ page 422) clockwise as far as it will go to secure the Minispare wheel.

i Arrow ② on vehicle tool kit storage well casing ④ must point in the direction of travel. Otherwise you cannot place the storage well casing (▷ page 422) on top and secure the Minispare wheel with the retaining screw (▷ page 422).

- ▶ Disengage trunk floor handle in upper edge of trunk and lower trunk floor cover.



Where will I find...?

- ▷▷ **!** To prevent damage, always disengage trunk floor handle from upper edge of trunk and lower trunk floor before closing the trunk.

Warning!



The dimensions of the Minispare wheel are different from those of the road wheels. As a result, the vehicle handling characteristics change when driving with a Minispare wheel mounted.

The Minispare wheel should only be used temporarily, and should be replaced with a regular road wheel as quickly as possible.

Do not switch off the ESP[®] when a Minispare wheel is mounted.

In case of a flat tire, you may temporarily use the Minispare wheel when observing the following restrictions:

- Do not exceed a vehicle speed of 50 mph (80 km/h).

- Drive to the nearest tire repair facility to have the flat tire repaired or replaced as appropriate.
- Do not operate vehicle with more than one Minispare wheel mounted.

For more information, see “Rims and tires” (▷ page 482).

Spare wheel bolts

The spare wheel bolts are fixed at the Minispare wheel.

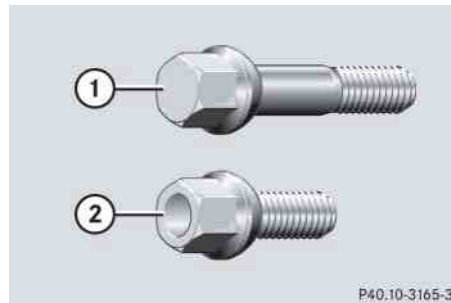

- ① Wheel bolt for light alloy rims
- ② Wheel bolt for Minispare wheel (located in trunk with spare wheel)

! Wheel bolts ② must be used when mounting the Minispare wheel. The use of any wheel bolts other than wheel bolts ② for the Minispare wheel will physically damage the vehicle's brakes.

Warning!



Make sure to use the original length wheel bolts when remounting the original wheel after it has been repaired.

Unlocking/locking in an emergency



▼ **Unlocking/locking in an emergency**

Unlocking the vehicle

If you are unable to unlock the vehicle with the SmartKey or KEYLESS-GO*, open the driver's door and the trunk using the mechanical key.

i *Unlocking and opening the driver's door and/or the trunk with the mechanical key will trigger the anti-theft alarm system.*

To cancel the alarm, do one of the following:

- Press button  or  on the SmartKey.
- Insert the SmartKey in the starter switch.
Vehicles with KEYLESS-GO:*
- Pull the outside door handle.
- Press the KEYLESS-GO* start/stop button (> page 39).

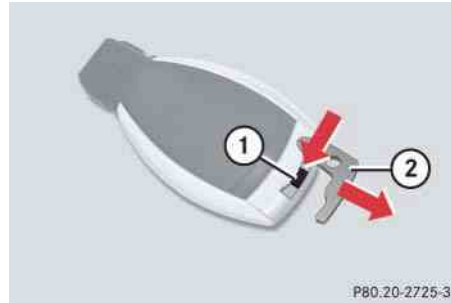

- ① Mechanical key locking tab
- ② Mechanical key
- ▶ Move locking tab ① in the direction of arrow.
- ▶ Slide mechanical key ② out of the housing.

Unlocking the driver's door

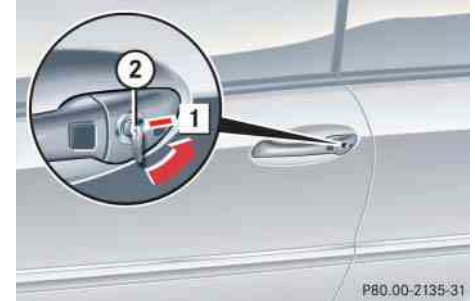

- 1 Unlocking
- ② Mechanical key

- ▶ Insert the mechanical key ② into the driver's door lock until it stops.
- ▶ Turn the mechanical key ② counter-clockwise to position 1 until the locking knob moves up.
The driver's door is unlocked.
- ▶ Pull the door handle to open the driver's door.

Unlocking/locking in an emergency

Unlocking the trunk

A minimum height clearance of 5.71 ft (1.74 m) (CLK coupe) or 5.41 ft (1.65 m) (CLK cabriolet) is required to open the trunk lid.

The trunk lid lock is located next to the handle above the rear license plate recess.

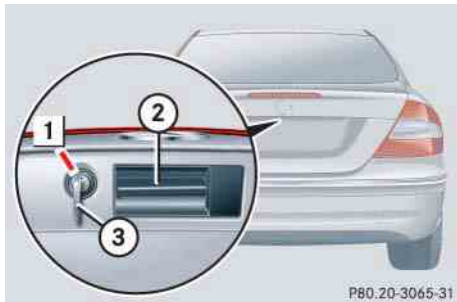

1 Unlocking in an emergency

② Handle

③ Mechanical key

- ▶ Insert the mechanical key ③ into the trunk lid lock until it stops.
- ▶ Turn the mechanical key ③ counterclockwise to position 1 and hold it in this position.
- ▶ Pull the trunk lid handle ② and lift the trunk lid.

The trunk opens.

! *The trunk lid swings open upwards automatically. Always make sure there is sufficient overhead clearance.*

- ▶ Turn the mechanical key ③ back and remove it from the trunk lid lock.

Locking the vehicle

If you cannot lock the vehicle with the SmartKey or SmartKey with KEYLESS-GO*, do the following:

- ▶ Close the passenger door and the trunk.
- ▶ Press the central locking switch in the center console (▷ page 118).
- ▶ Check to see whether the locking knob on the passenger door has moved down.
- ▶ If necessary, push it down manually.
- ▶ Remove the mechanical key out of the SmartKey (▷ page 427).
- ▶ Check whether the trunk is locked.
- ▶ If necessary, lock the trunk with the mechanical key (▷ page 118).

Except for the driver's door, the vehicle should now be locked.

Unlocking/locking in an emergency

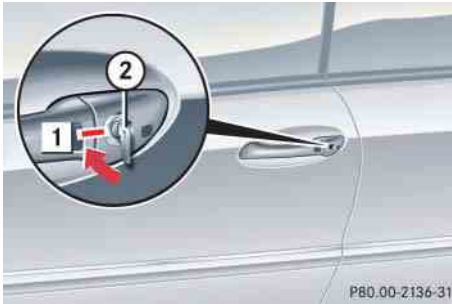

1 Locking

② Mechanical key

- ▶ Insert the mechanical key ② into the driver's door lock until it stops.
- ▶ Turn the mechanical key ② clockwise to position 1.

The driver's door is locked.

i This procedure does not arm the anti-theft alarm system, nor does it lock the fuel filler flap.

Manually unlocking the gear selector lever

In case of power failure, the gear selector lever can be manually unlocked, e.g. to tow the vehicle.

i The gear selector lever is locked again when moving it to position **P**.

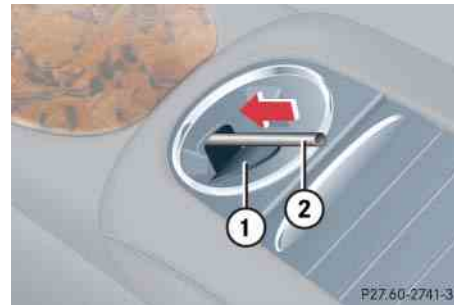

① Tab

② tool (e.g. flat blade screwdriver)

- ▶ Pull the tab ① of the covering back in direction of the center armrest compartment.
- ▶ Insert a tool ② (e.g. flat blade screwdriver) into the opening.
- ▶ Perform the following two steps simultaneously:
 - ▶ Push tool ② down- and forward in the direction of the arrow.
 - ▶ Move gear selector lever from position **P**.
- ▶ Remove the tool ② from the opening.
- ▶ Push the tab ① of the covering back.

Opening/closing in an emergency (Cabriolet)

Operating roll bars manually

Releasing roll bars manually

If the roll bar system is malfunctioning, you can release the roll bars manually.

Warning!



If the yellow roll bar warning lamp  in the clock does not go out after starting the engine, or if it comes on while driving, then the roll bar system is not operating properly and may not activate in an accident. In this case, raise the roll bars manually before continuing to drive.

For safety reasons drive only with the roll bars raised until the malfunction is repaired. Have your vehicle checked at an authorized Mercedes-Benz Center.

- ▶ Close the soft top (▷ page 261).

i *With the roll bars released, the soft top cannot be operated using the soft top switch and the rear head restraints cannot be lowered using the rear head restraint lowering switch.*

- ▶ Open the trunk (▷ page 110).
- ▶ Fold back the luggage cover (▷ page 264).
- ▶ Take hex wrench out of its storage location in the storage well casing (▷ page 422).

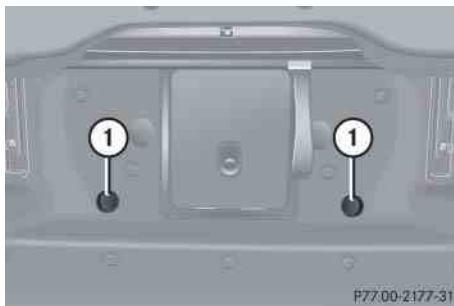

① Perforation

- ▶ Push hex wrench through perforation ① in trim of rear wall in trunk.

Warning!



Make sure no one is located in the roll bar's path of motion while the next steps are being carried out.

When the roll bar is manually released, the rear head restraints and the roll bar underneath shoot up almost instantaneously.

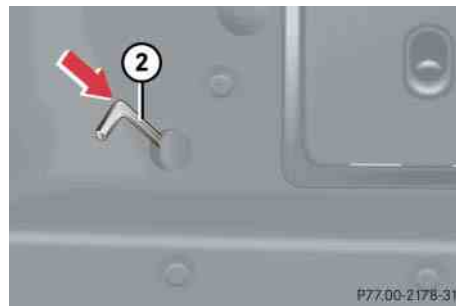

② Hex wrench

Opening/closing in an emergency (Cabriolet)

- ▶ Insert long side of hex wrench ② into opening.
- ▶ Using hex wrench ②, press release catch down in direction of arrow.

The roll bar extends with a loud sound.

- ▶ Repeat this step for the second roll bar.

Have the systems checked at an authorized Mercedes-Benz Center as soon as possible.

Lowering roll bars manually

With the soft top open, you can lower the roll bars manually after they have been released.

i With the roll bars released, the soft top cannot be operated using the soft top switch and the rear head restraints cannot be lowered using the rear head restraint lowering switch.

Warning!



Never lower the roll bars manually unless the soft top is open. Otherwise, the roll bars function could be impaired, no longer reducing your risk of injury in an optimal manner.

Contact an authorized Mercedes-Benz Center to have the roll bar lowered when the soft top is closed.

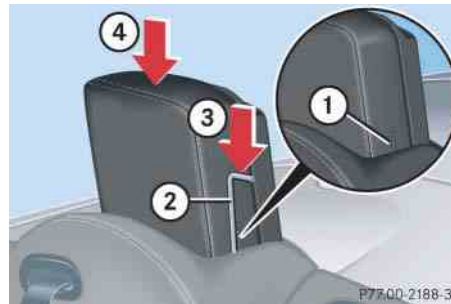

- ① Orientation seam
- ② Hex wrench
- ③ Press wrench down
- ④ Press head restraint down

- ▶ Take hex wrench out of its storage location in the storage well casing (▷ page 422).
- ▶ Align hex wrench so that its long side is parallel to orientation seam ① and insert hex wrench ② into gap on left side of respective head restraint.
- ▶ Press hex wrench down firmly in direction of arrow ③ and hold.
- ▶ Press head restraint down in direction of arrow ④.
- ▶ Pull hex wrench ② out and take weight off head restraint.
- ▶ Repeat this procedure on roll bar for second head restraint.

Opening/closing in an emergency (Cabriolet)

Soft top emergency operation

If the soft top cannot be automatically closed, check the following:

- Is the luggage cover engaged in place (▷ page 264)?
- Have the roll bars been released? If so, lower the roll bars manually (▷ page 431).
- Is the trunk lid closed (▷ page 112)?
- Is there sufficient on-board voltage? Start the engine if necessary.

These messages will also appear in the multifunction display (▷ page 420).

If automatic operation still does not function properly, you can close the soft top manually.

This procedure should be performed with great care by two persons.

! *Manually closing the soft top is a complicated and technically demanding procedure. Close the soft top manually in emergency cases only. Otherwise, visit an authorized Mercedes-Benz Center. Please read the instructions fully before beginning operation and only undertake it with another person and if you feel fully capable of performing the tasks involved.*

Warning!



- It is important that a second person helps you. Otherwise, you could become trapped or injured.
- Remove any wristwatches or jewelry such as rings or bracelets. Otherwise, they could get caught in the vehicle mechanism, causing personal injury to yourself or damage to the vehicle.
- Always use the grips provided as indicated. Otherwise you could injure yourself.

- ▶ Engage parking brake.
- ▶ Lower the side windows.

- ▶ Lower rear head restraints (▷ page 123).

i *If the rear head restraints cannot be lowered using the rear head restraint lowering switch, the roll bars may have been released. For more information, see “Operating roll bars manually” (▷ page 430).*

- ▶ For safety reasons, remove SmartKey from starter switch.
- ▶ Open the trunk.
- ▶ Remove the trunk floor cover.
- ▶ Take the two straps for soft top emergency operation out of vehicle tool kit (▷ page 422).
- ▶ Take hex wrench out of its storage location in the storage well casing (▷ page 422).
- ▶ Open the left side trim panel in the trunk.

Opening/closing in an emergency (Cabriolet)



① Locking mechanism

- ▶ Pull locking mechanism ① out until it stops and rotate it approximately one-quarter of a turn.
- ▶ Make sure the locking mechanism does not retract again. If this happens, pull the locking mechanism out again and rotate it approximately one-quarter of a turn.

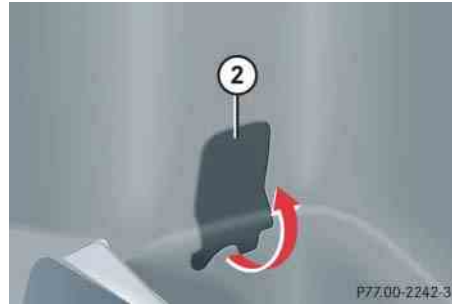

② Trim

- ▶ Fold the right-hand side of the trunk floor away.
- ▶ Detach trim ② along the perforation.

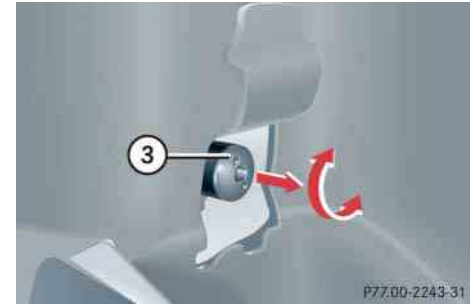

③ Locking mechanism

- ▶ Pull locking mechanism ③ out until it stops and rotate it approximately one-quarter of a turn.
- ▶ Make sure the locking mechanism does not retract again. If this happens, pull the locking mechanism out again and rotate it approximately one-quarter of a turn.



Opening/closing in an emergency (Cabriolet)

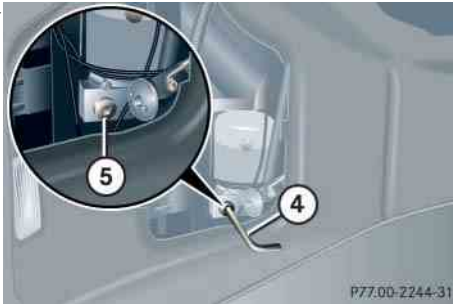

- ④ Hex wrench
- ⑤ Screw of hydraulic pump

- ▶ Insert hex wrench ④ into screw ⑤.
- ▶ Turn hydraulic pump screw ⑤ counter-clockwise one revolution with hex wrench ④.

! Do not operate the soft top switch with screw ⑤ in the opened position, otherwise the hydraulic pump could be damaged.

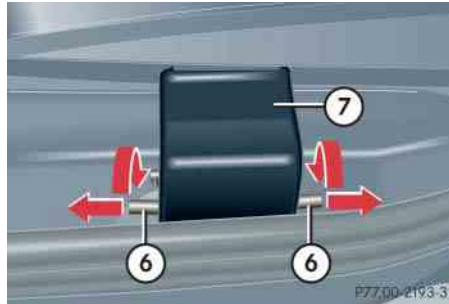

- ⑥ Lever
- ⑦ Soft top storage compartment hinge

The soft top storage compartment hinges are located on the left and right of the space between the soft top compartment cover and the trunk seal.

- ▶ Pull the two levers ⑥ apart and fold levers ⑥ of soft top storage compartment hinge ⑦ forward on both sides over the detent position.

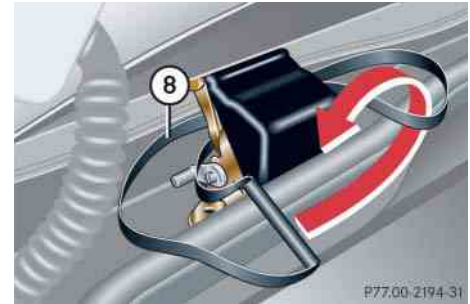

- ⑧ Strap

- ▶ Pull strap ⑧, supplied in vehicle tool kit, behind soft top storage compartment through hinge ⑦.
- ▶ Bring strap together in front of hinge.
- ▶ Pull the side with the handle through the loop on the opposite side.

Opening/closing in an emergency (Cabriolet)



- ▶ Pull strap between soft top storage compartment hinge and soft top compartment.
- ▶ Secure second strap to second hinge in the same manner.

! Do not pull the straps when the trunk is open.



- ▶ Place both straps on soft top compartment cover.
- ▶ Take hex wrench out of trunk.
- ▶ Close trunk lid.

You will only have access to the trunk again when the emergency operation has been completed.

i Do not place the SmartKey in the open trunk. You may lock yourself out.

Vehicles with KEYLESS-GO*: To prevent a possible inadvertent lockout, the trunk lid will open automatically if a SmartKey with KEYLESS-GO* is recognized in the area of the rear shelf or inside the trunk.

! The trunk lid must remain closed during the next steps in the procedure. Otherwise the trunk lid and the soft top compartment cover may come into contact with one another and be damaged.

Warning!



At this point, the remaining procedure needs to be done by two people. Otherwise you could be injured.



Opening/closing in an emergency (Cabriolet)

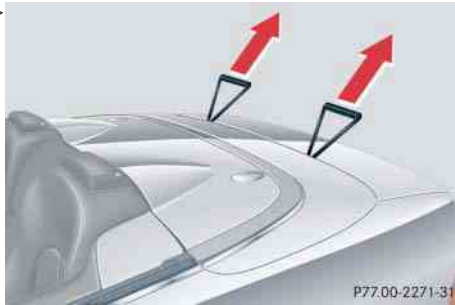

- ▶ You and your assistant should each take one of the straps by the handle.
- ▶ With a strong, simultaneous tug on the loops, pull soft top compartment cover upward and out to the rear.



- ⑨ Soft top compartment cover
- ▶ One person should stand on the left side of the vehicle and the other on the right side.

Warning!



In the next step, you and your assistant should each take hold of the soft top compartment cover as shown in the illustration. Both of you should use your free hand to support yourselves on the edge of the trunk lid as shown in the illustration.

If either you or your helper assume a different position, one or both of you could be trapped or injured.

- ▶ Pulling the cover back in one smooth motion, lift soft top compartment cover ⑨ into a vertical position until it stops.

! *Make sure the soft top storage compartment hinges do not fold down during this procedure. Otherwise your vehicle could be damaged.*

Opening/closing in an emergency (Cabriolet)



⑩ Edge of soft top

- ▶ From left and right sides, reach into soft top compartment underneath edge of soft top ⑩.



⑪ Windshield frame

- ▶ Lift soft top out of soft top compartment and pull it forward to windshield frame ⑪.

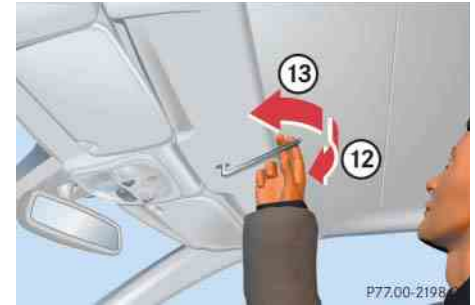

⑫ Opening

⑬ Locking

- ▶ Take off protective cap on the inner side of the soft top.
- ▶ Insert hex wrench into soft top locking mechanism screw.
- ▶ Turn the soft top locking mechanism screw with hex wrench clockwise in direction of arrow ⑫ as far as it will go.

The clasp will open and the soft top will engage audibly. ▷▷

Warning!



Do not place your hands near the upper windshield area, trunk lid, or between soft top roof panels and hinges while the soft top is being raised and locked. Serious personal injury may occur.

Opening/closing in an emergency (Cabriolet)

- ▷▷▶ Turn the soft top locking mechanism screw with hex wrench counterclockwise in direction of arrow (13) as far as it will go.

The clasp will close and the soft top is now locked onto the windshield frame.

! Make sure you turn the hex wrench counterclockwise as far as it will go. Otherwise the soft top may not lock properly.



⑭ Material tensioning frame

⑮ Soft top compartment cover

- ▶ Lift material tensioning frame (14) into a vertical position.
- ▶ Lower soft top compartment cover (15).

! Make sure the soft top compartment cover (15) does not collide or make contact with the material tensioning frame (14).



⑯ Soft top base

- ▶ With the palm of your hand, press the window in material tensioning frame (14) until it is positioned on the soft top compartment cover (15).

Opening/closing in an emergency (Cabriolet)



- ▶ You and your assistant should press soft top compartment cover (15) forward and down with the palms of your hands until it snaps into place in the guide. Place your hands on the areas indicated by the arrows.

At the same time, gently press material tensioning frame (14) down with the palms of your hands.

Warning!



Position hands as indicated by arrows so that when you press soft top compartment cover (15) forward and lower material tensioning frame (14), your hands cannot become trapped.

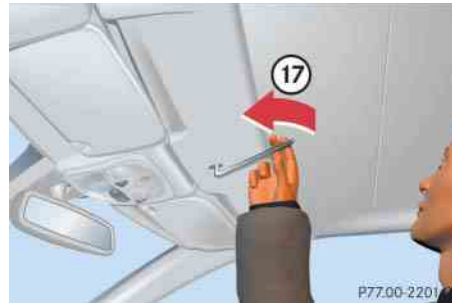

⑰ Locking

- ▶ Insert hex wrench into soft top locking mechanism screw.

- ▶ Turn the soft top locking mechanism screw with hex wrench counterclockwise in direction of arrow (17) as far as it will go.

The soft top is locked onto the windshield frame.

! Make sure you turn the hex wrench counterclockwise as far as it will go. Otherwise the soft top may not lock properly.

- ▶ Have the soft top operation checked at an authorized Mercedes-Benz Center as soon as possible.

! If, after completing the soft top emergency operation, the trunk cannot be opened using the remote trunk lid release switch in the driver's door, the  button on the SmartKey, or the trunk lid release handle in the license plate recess, press the soft top compartment cover down again as described above.

Do not open the trunk with the emergency key, as this could otherwise damage the trunk lid and the soft top compartment cover.

Resetting activated head restraints

Resetting activated head restraints

If the active head restraints have been triggered in a rear-end collision, the active head restraints must be reset. Otherwise, the active head restraints cannot offer any additional protection in the event of another rear-end collision.

You can tell that the head restraints have been triggered when they have been moved forward and cannot be adjusted.

i For your convenience, we recommend that you have this work carried out at an authorized Mercedes-Benz Center.

You will find the reset tool for manually operating the active head restraints in the Mercedes-Benz vehicle literature pouch.

Warning!



For safety reasons, have the active head restraints checked at an authorized Mercedes-Benz Center after a rear-end collision.

Warning!



When pushing back the head restraint cushion, take care that your fingers do not become caught between the head restraint cushion and the cover. Failing to do so may lead to injury.



- ① Reset tool
- ② Hole
- ③ Press head restraint cushion

- ▶ Take the reset tool ① out of the Mercedes-Benz vehicle literature pouch.

- ▶ Guide reset tool ① into the hole ② between the rear head restraint cover and the head restraint cushion.

! Be careful not to damage upholstery.

- ▶ Press the reset tool ① downward until you hear the active head restraint release mechanism audibly engage.
- ▶ Pull out reset tool ①.
- ▶ Firmly press the head restraint cushion back in direction of arrow ③ toward the rear head restraint cover until it engages.
- ▶ Repeat this procedure on the active head restraint for the second front seat.
- ▶ After resetting the active head restraints store the reset tool ① in the Mercedes-Benz vehicle literature pouch.

For information on active head restraints, see “Active head restraints” (▷ page 81).

For information on head restraint adjustment, see “Seats” (▷ page 41).

Replacing SmartKey batteries

▼ Replacing SmartKey batteries

If the batteries in the SmartKey or the SmartKey with KEYLESS-GO* are discharged, the vehicle can no longer be locked or unlocked. It is recommended to have the batteries replaced at an authorized Mercedes-Benz Center.

Warning!

Batteries contain poisonous and corrosive substances. Therefore keep the batteries out of reach of children.

If a battery is swallowed, seek medical help immediately.

Warning!

SmartKey batteries contain Perchlorate material, which may require special handling and regard for the environment. Check with your local government's disposal guidelines. California residents, see <http://www.dtsc.ca.gov/HazardousWaste/Perchlorate/index.cfm>.

Batteries contain materials that can harm the environment if disposed of improperly. Recycling of batteries is the preferred method of disposal. Many states require sellers of batteries to accept old batteries for recycling.

 *When inserting the batteries, make sure they are clean and free of lint.*

 *When changing batteries, always replace both batteries.*

The required replacement batteries are available at any Mercedes-Benz Center.

Replacing SmartKey batteries

SmartKey / SmartKey with KEYLESS-GO*

Replacement batteries: Lithium, type CR 2025 or equivalent.

- ▶ Remove the mechanical key from the SmartKey or SmartKey with KEYLESS-GO* (▷ page 427).

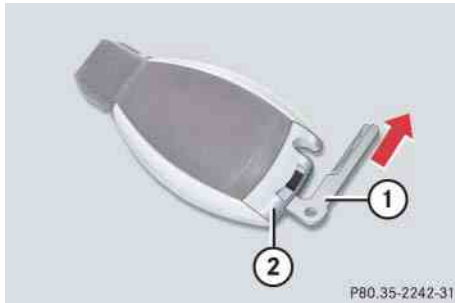

- ① Mechanical key
- ② Battery compartment

- ▶ Insert mechanical key ① into the opening.
- ▶ Press mechanical key ① in direction of arrow.

The battery compartment ② is unlatched.

- ▶ Pull battery compartment ② out of the housing.

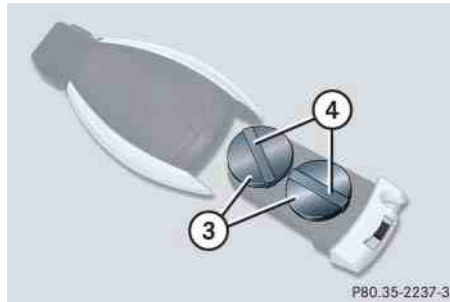

- ③ Batteries
- ④ Contact spring

- ▶ Remove the batteries ③.
- ▶ Using a lint-free cloth, insert new batteries ③ under the contact springs ④ with the positive terminal (+) side facing up.
- ▶ Return battery compartment ② into housing until it locks into place.
- ▶ Slide mechanical key ① back into the SmartKey.
- ▶ Check the operation of the SmartKey.

▼ Replacing bulbs

Safe vehicle operation depends on proper exterior lighting and signaling. It is therefore essential that all bulbs and lamp assemblies are in good working order at all times.

Correct headlamp adjustment is extremely important. Have headlamps checked and readjusted at regular intervals and when a bulb has been replaced. See an authorized Mercedes-Benz Center for headlamp adjustment.

i *If the headlamps or front fog lamps are fogged up on the inside as a result of high humidity, driving the vehicle a distance with the lights on should clear up the fogging.*

i *Backup bulbs will be brought into use when lamps malfunction. Read and observe the messages in the multifunction display (▷ page 411).*

Replacing bulbs

Bulbs



Front lamps

	Lamp	Type
①	Additional turn signal lamp	LED
②	Turn signal lamp	1156 NA
③	Halogen headlamp: Low beam	H7 (55 W)
	Bi-Xenon* headlamp: Low and high beam ¹	D2S-35 W
④	Halogen headlamp: High beam/high beam flasher	H7 (55 W)
	Bi-Xenon* headlamp: High beam flasher	H7 (55 W)
	Parking and standing lamp	W 5 W
	Front fog lamp Corner-illuminating front fog lamp*	H11 (55 W) H11 (55 W)
⑤	Side marker lamp	W 5 W

¹ Vehicles with Bi-Xenon headlamps* do not replace the Bi-Xenon bulbs yourself.

Rear lamps

	Lamp	Type
⑦	High mounted brake lamp	LED
⑧	Brake lamp	P 21 W
⑨	Turn signal lamp	PY 21 W
⑩	Tail, parking and stand- ing lamp, side marker lamp	P 21/5 W
⑪	Backup lamp	P 21 W
⑫	License plate lamps	C 5 W
⑬	Rear fog lamp (driver's side only) and tail lamp	P 21/4 W

Warning!

Keep bulbs out of reach of children.

Bulbs and bulb sockets can be very hot. Allow the lamp to cool down before changing a bulb.

Halogen lamps contain pressurized gas. A bulb can explode if you:

- touch or move it when hot
- drop the bulb
- scratch the bulb

Wear eye and hand protection.

Because of high voltage in Xenon lamps, it is dangerous to replace the bulb or repair the lamp and its components. We recommend that you have such work done by a qualified technician.

Notes on bulb replacement

- Only use 12 volt bulbs of the same type and with the specified watt rating.
- Switch lights off before changing a bulb to prevent short circuits.
- Always use a clean lint-free cloth when handling bulbs.
- Your hands should be dry and free of oil and grease.
- If the newly installed bulb does not come on, visit an authorized Mercedes-Benz Center.

Have the LEDs and bulbs for the following lamps replaced at an authorized Mercedes-Benz Center.

- Additional turn signal lamps in the exterior rear view mirrors
- High mounted brake lamp
- Bi-Xenon* lamps
- Front fog lamps
- Front side marker lamps

! Do not replace the LEDs yourself. You could otherwise damage the LEDs or parts of the vehicle. Only have the LEDs replaced at an authorized Mercedes-Benz Center.

Replacing bulbs

Replacing bulbs for front lamps

Before you start to replace a bulb for a front lamp, do the following first:

- ▶ Turn the exterior lamp switch to position **0** (▷ page 129).
- ▶ Open the hood (▷ page 323).

Front lamps halogen-type

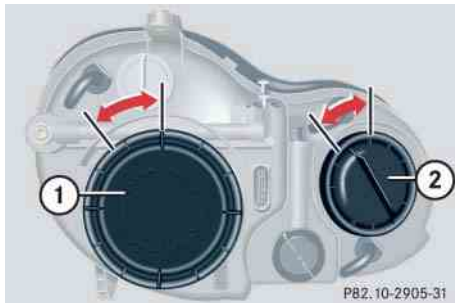

- ① Housing cover for low beam headlamp
- ② Housing cover for high beam headlamp, parking and standing lamp

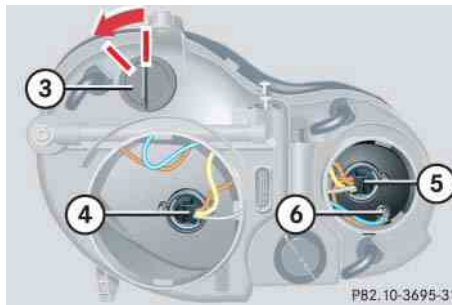

- ③ Bulb socket for turn signal lamp bulb
- ④ Bulb holder of low beam bulb
- ⑤ Bulb holder of high beam bulb
- ⑥ Bulb socket for parking and standing lamp bulb

Low beam bulb

- ▶ Turn housing cover ① counterclockwise and remove it.
- ▶ Turn bulb holder ④ with the bulb counterclockwise and remove it.
- ▶ Pull the bulb at its socket out of bulb holder ④.

- ▶ Insert the new bulb so that its socket locates in the recess of bulb holder ④ and is level to it.
- ▶ Reinsert bulb holder ④ with the bulb in the lamp and turn clockwise.
- ▶ Align housing cover ① and turn it clockwise.

High beam bulb

- ▶ Turn housing cover ② counterclockwise and remove it.
- ▶ Turn bulb holder ⑤ with the bulb counterclockwise and remove it.
- ▶ Pull the bulb at its socket out of bulb holder ⑤.
- ▶ Insert the new bulb so that its socket locates in the recess of bulb holder ⑤ and is level to it.
- ▶ Reinsert bulb holder ⑤ with the bulb in the lamp and turn clockwise.
- ▶ Align housing cover ② and turn it clockwise.

Front turn signal lamp bulb

- ▶ Turn bulb socket ③ counterclockwise and remove it.
- ▶ Press gently onto the bulb and turn counterclockwise out of bulb socket ③.
- ▶ Press the new bulb gently into bulb socket ③ and turn clockwise until it engages.
- ▶ Place bulb socket ③ back into the lamp and turn it clockwise.

Parking and standing lamp bulb

- ▶ Turn housing cover ② counterclockwise and remove it.
- ▶ Pull out bulb socket ⑥ with the bulb.
- ▶ Pull the bulb out of the bulb socket ⑥.
- ▶ Press the new bulb into bulb socket ⑥.
- ▶ Press bulb socket ⑥ back into the lamp.
- ▶ Align housing cover ② and turn it clockwise.

Front lamps Bi-Xenon*-type

Warning!



Do not remove the cover ③ for the Bi-Xenon* headlamp. Because of high voltage in Xenon lamps, it is dangerous to replace the bulb or repair the lamp and its components. We recommend that you have such work done by a qualified technician.

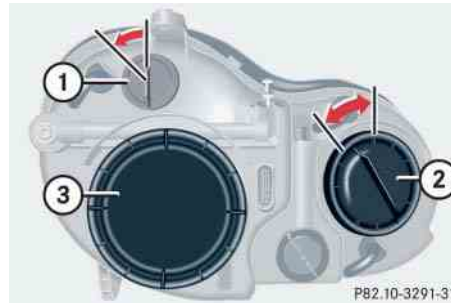

- ① Bulb socket for turn signal lamp
- ② Housing cover for high beam flasher, parking and standing lamp
- ③ Housing cover for Bi-Xenon* headlamp



- ④ Bulb holder for high beam flasher bulb
- ⑤ Bulb socket for parking and standing lamp bulb

High beam bulb for high beam flasher

- ▶ Turn housing cover ② counterclockwise and remove it.
- ▶ Turn bulb holder ④ with the bulb counterclockwise and remove it.
- ▶ Pull the bulb at its socket out of bulb holder ④.
- ▶ Insert the new bulb so that its socket locates in the recess of bulb holder ④ and is level to it.



Replacing bulbs

- ▷▷ Reinsert bulb holder ④ with the bulb in the lamp and turn clockwise.
- ▶ Align housing cover ② and turn it clockwise.

Front turn signal lamp bulb

- ▶ Turn bulb socket ① counterclockwise and remove it.
- ▶ Press gently onto the bulb and turn counterclockwise out of bulb socket ①.
- ▶ Press the new bulb gently into bulb socket ① and turn clockwise until it engages.
- ▶ Place bulb socket ① back into the lamp and turn it clockwise.

Parking and standing lamp bulb

- ▶ Turn housing cover ② counterclockwise and remove it.
- ▶ Pull out bulb socket ⑤ with the bulb.
- ▶ Pull the bulb out of the bulb socket ⑤.

- ▶ Press the new bulb into bulb socket ⑤.
- ▶ Press bulb socket ⑤ back into the lamp.
- ▶ Align housing cover ② and turn it clockwise.

Additional turn signal lamps

The additional turn signal lamps in the exterior rear view mirrors have LEDs.

If a malfunction occurs or LEDs fail to function, the entire turn signal unit must be replaced. Have the additional turn signal unit replaced at an authorized Mercedes-Benz Center.

Front side marker lamp

Since replacing the side marker lamp bulbs is a technically highly demanding process, we recommend you have the side marker lamp bulbs replaced at an authorized Mercedes-Benz Center.

Replacing bulbs for rear lamps

Before you start to replace a bulb for a rear lamp, do the following first:

- ▶ Turn the exterior lamp switch to position **0** (▷ page 129).

Tail lamp unit

- ▶ Open trunk lid.
- ▶ Swing the trim panel covering the corresponding rear lights to the side.

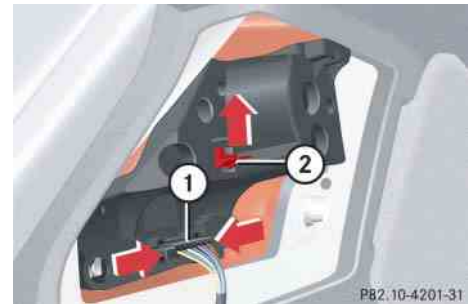

- ① Connector
- ② Tab

- ▶ Disconnect electrical connector ①.

- ▶ Pull tab ② in the direction of the arrow.
- ▶ Remove the bulb carrier.

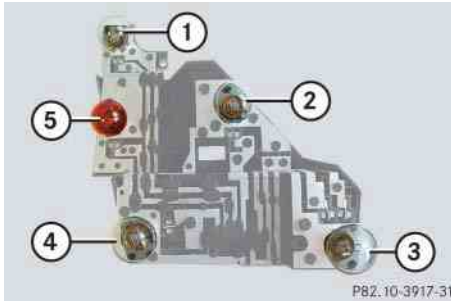

- ① Brake lamp
 - ② Backup lamp
 - ③ Rear fog lamp (driver's side)/tail lamp
 - ④ Tail lamp, parking and standing lamp, side marker lamp
 - ⑤ Turn signal lamp
- ▶ Press gently onto the respective bulb and turn counterclockwise out of its bulb socket.
 - ▶ Press the new bulb gently into its bulb socket and turn clockwise until it engages.

- ▶ Reinstall the bulb carrier.
Let tab ② (> page 448) engage.
- ▶ Connect the electrical connector ① (> page 448) until it engage.
- ▶ Reinstall trim panel.

License plate lamp

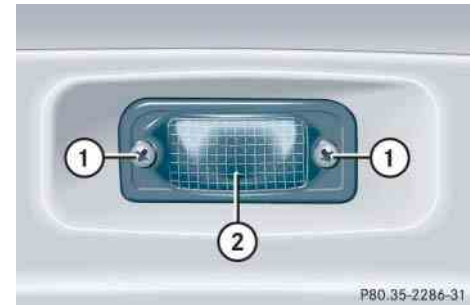

- ① Screws
 - ② License plate lamp
- ▶ Loosen both screws ①.
 - ▶ Remove the license plate lamp ②.
 - ▶ Replace the tubular lamp.
 - ▶ Reinstall the license plate lamp ②.
 - ▶ Retighten the screws ①.

Replacing wiper blades

Removing and installing wiper blades

Warning!



For safety reasons, switch off wipers and remove SmartKey from starter switch (vehicles with KEYLESS-GO*: make sure the vehicle's on-board electronics have status **0**) before replacing a wiper blade. Otherwise, the wiper motor could suddenly turn on and cause injury.

Warning!



Wiper blades are components that are subject to wear and tear. Replace the wiper blades twice a year, preferably in the spring and fall. Otherwise the windows will not be properly wiped. As a result, you may not be able to observe surrounding traffic conditions and could cause an accident.

! Never open the hood when the wiper arms are folded forward.

For your convenience, we recommend that you have this work carried out at an authorized Mercedes-Benz Center.

- ▶ Remove SmartKey from starter switch (vehicles with KEYLESS-GO*: make sure the vehicle's on board electronics have status **0**).

Removing wiper blades

! Do not pull on the wiper blade inserts. They could tear.

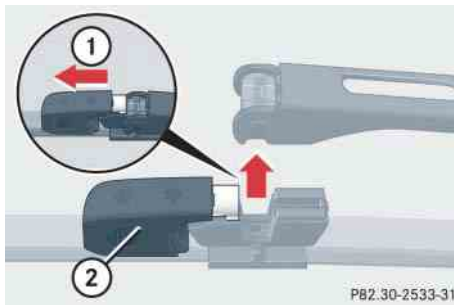

- ① Unlocking
- ② Tab

- ▶ Pull the tab ② in the direction of arrow ①.

The wiper blade is unlocked.

- ▶ Lift up the wiper arm as far as you need to remove the wiper blade.

! Hold on to the wiper arm. If released, the force of the impact from the tensioning spring could crack the windshield.

- ▶ Carefully fold the wiper arm back to rest on the windshield.

Installing wiper blades

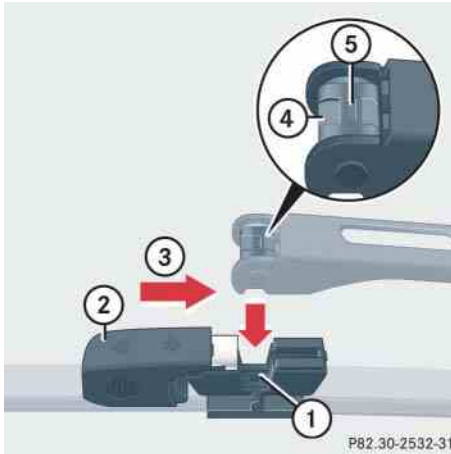

P82.30-2532-31

- ① Recess
- ② Tab
- ③ Locking
- ④ Taper piece
- ⑤ Square recess

- ▶ Lift up the wiper arm as far as you need to position the wiper blade under the wiper arm and hold it.

! Hold on to the wiper arm. If released, the force of the impact from the tensioning spring could crack the windshield.

- ▶ Carefully fold the wiper arm back and make sure the taper piece ④ slides into the recess ① at the wiper blade.

! Make certain that the square recess ⑤ on the taper piece ④ is on the top, otherwise the taper piece ④ cannot slide into the recess ① at the wiper blade. If the square recess ⑤ is not at the top turn the taper piece ④ around to bring the square recess ⑤ to the top.

- ▶ Slide the tab ② back in the direction of arrow ③ until it audibly engages.

The wiper blade is locked.

! Make certain that the wiper blades are properly installed. Improperly installed wiper blades may cause windshield damage.

Flat tire

The CLK 63 AMG is equipped with a TIREFIT kit.

Preparing the vehicle

- ▶ Park the vehicle in a safe distance from moving traffic on a hard, flat surface when possible.
- ▶ Turn on the hazard warning flasher (▷ page 135).
- ▶ Turn the steering wheel so that the front wheels are in a straight ahead position.
- ▶ Set the parking brake (▷ page 59).
- ▶ Move the gear selector lever to **P**.

Vehicles with SmartKey:

- ▶ Turn off the engine (▷ page 60).
- ▶ Remove the SmartKey from the starter switch.

Vehicles with SmartKey with KEYLESS-GO*:

- ▶ Turn off the engine by pressing the KEYLESS-GO* start/stop button on the gear selector lever once (▷ page 60).
 - ▶ Open the driver's door (with driver's door open, starter switch is now in position **0**, same as with SmartKey removed from starter switch). The driver's door then can be closed again.
-  *Open door only when conditions are safe to do so.*
- ▶ Have any passenger exit the vehicle at a safe distance from the roadway.

Sealing tires with TIREFIT (CLK 63 AMG only)

Small tire punctures, particularly those in the tread, can be sealed with TIREFIT. TIREFIT can be used in ambient temperatures down to -4°F (-20°C).

Warning!



TIREFIT is a limited repair device. TIREFIT cannot be used for cuts or punctures larger than approximately 0.16 in (4 mm) and tire damage caused by driving with extremely low tire inflation pressure, or on a flat tire, or a damaged wheel.

Do not drive the vehicle under such circumstances.

Contact the nearest Mercedes-Benz Center for assistance or call Roadside Assistance.

- ▶ Foreign objects (e.g. screws or nails) should not be removed from the tire.
- ▶ Take TIREFIT, the sticker, and the electric air pump out of the trunk (> page 422).

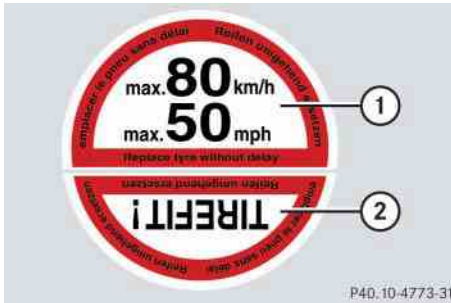

Two-part sticker

- ① Sticker for instrument cluster
- ② Sticker for wheel
- ▶ Attach sticker part ① where it will be easily seen by the driver on the instrument cluster.
- ▶ Attach sticker part ② to the damaged tire (close to the tire valve).

Warning!



Take care not to allow the contents of TIREFIT to come in contact with hair, eyes or clothing. TIREFIT is harmful if inhaled, swallowed or absorbed through the skin - causes skin, eye and respiratory irritation.

Any contact with eyes or skin should be flushed immediately with plenty of water.

If clothing comes in contact with TIREFIT, change clothing as soon as possible.

In case of allergic reaction or rash, consult a physician immediately.

Warning!



Keep TIREFIT out of reach of children. If swallowed, rinse mouth immediately with plenty of water and drink plenty of water.

Do not induce vomiting!

Consult a physician immediately.

Keep away from open flame or heat source.

i If sealant has leaked out, let it dry. You can then peel it off.

Warning!



Observe safety instructions on air pump label.

i Your vehicle may be equipped with either of two versions of the electric air pump:

- Version 1
The air hose with pressure gauge and the electrical plug are located behind a flap.
- Version 2
The pressure gauge is located in the pump housing.

The following description applies to both versions. Differences in usage are expressly declared.

Flat tire



Version 1

- ① TIREFIT container
- ② Notch
- ③ Electric air pump switch
- ④ Electrical plug
- ⑤ Air hose
- ⑥ Flange
- ⑦ Flap

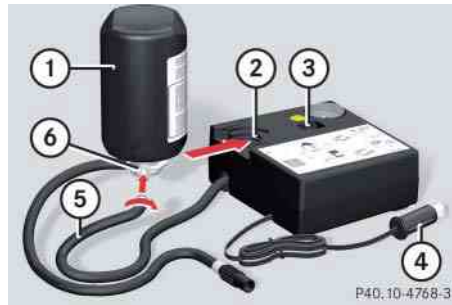

Version 2

- ① TIREFIT container
 - ② Notch
 - ③ Electric air pump switch
 - ④ Electrical plug
 - ⑤ Air hose
 - ⑥ Flange
- ▶ Open flap ⑦ on the electric air pump **(version 1 only)**.
 - ▶ Pull plug ④ and air hose ⑤ out of the pump housing.

- ▶ Screw the air pump's air hose ⑤ onto flange ⑥ of TIREFIT container ①.
- ▶ Stick TIREFIT container ① upside down into notch ② of the electric air pump.

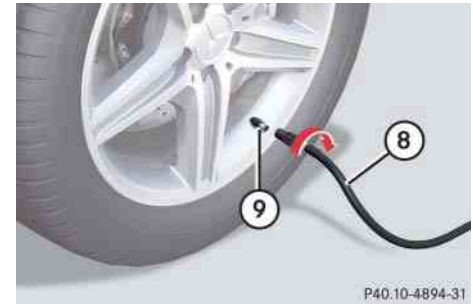

- ⑧ Filler hose
 - ⑨ Tire valve
- ▶ Unscrew the valve cap of the damaged tire from tire valve ⑨.

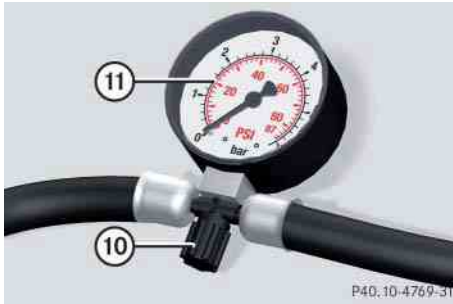

Version 1

⑩ Vent screw

⑪ Pressure gauge

- ▶ Close vent screw ⑩ on pressure gauge ⑪ (**version 1 only**).
- ▶ Screw filler hose ⑧ onto tire valve ⑨.
- ▶ Insert electrical plug ④ into the cigarette lighter (▷ page 290) or the power outlet in the rear passenger compartment (▷ page 291).

- ▶ Turn the SmartKey in the starter switch to position **1** (▷ page 38).

Vehicles with KEYLESS-GO*:

- ▶ Press the KEYLESS-GO* start/stop button (▷ page 40) on the gear selector lever once. Do not depress brake pedal.
- ▶ Press **I** on electric air pump switch ③.
The electric air pump is switched on and inflates the tire.

i *First, the sealing is pumped into the tire. The pressure may briefly rise to up to 73 psi (5 bar). This is normal and not an indication of a malfunction. Do not switch off the electric air pump.*

- ▶ Let the electric air pump inflate the tire for approximately 5 minutes.
The pressure gauge must display at least 26 psi (1.8 bar). The air hose can become hot during inflation. Please exercise appropriate caution.

! *Do not operate the electric air pump longer than 6 minutes without interruption. Otherwise it may overheat.*

You may operate the air pump again after it has cooled off.

- ▶ If the tire inflation pressure of at least 26 psi (1.8 bar) is not attained, turn off the electric air pump by pressing **0** on electric air pump switch ③ (▷ page 454).
- ▶ Detach filler hose ⑧ from tire valve ⑨ (▷ page 454).
- ▶ Drive vehicle back and forth very slowly approximately 30 ft (10 m).
This serves to better distribute the TIREFIT sealant material inside the tire.
- ▶ Unscrew the air pump's air hose ⑤ from flange ⑥ of TIREFIT container ① (▷ page 454).
- ▶ Screw air hose ⑤ onto tire valve ⑨.
- ▶ Inflate the tire again.



Flat tire



Warning!



If a tire inflation pressure of 26 psi (1.8 bar) is not attained, the tire is too severely damaged for TIREFIT to provide a reliable tire repair.

In this case, TIREFIT cannot properly seal the tire.

Do not drive the vehicle.

Contact the nearest Mercedes-Benz Center or call Roadside Assistance.

- ▶ After attaining a tire inflation pressure of 26 psi (1.8 bar), press **0** on electric air pump switch ③ (▷ page 454).

The electric air pump is switched off.

- ▶ Turn the SmartKey in the starter switch to position **0** (▷ page 38).

Vehicles with KEYLESS-GO*:

- ▶ Press the KEYLESS-GO* start/stop button (▷ page 40) on the gear selector lever twice. Do not depress brake pedal.
- ▶ Detach the electric air pump.
The air hose may still be hot. Please exercise appropriate caution.
- ▶ Place the electrical air pump back in the trunk.
- ▶ Close the trunk.
- ▶ Drive off immediately.
The TIREFIT sealant will distribute itself evenly inside the tire.

Warning!



Do not exceed vehicle speed of 50 mph (80 km/h). A TIREFIT repair is not designed to operate at higher speeds.

The sticker must be attached on the instrument cluster where it will be easily seen by the driver.

Vehicle handling characteristics of a TIREFIT repaired tire may change. Adapt your driving accordingly.

- ▶ After driving the vehicle for an initial 10 minutes, check the tire inflation pressure using pressure gauge ⑪ on the air pump.

Warning!



If tire inflation pressure has fallen below 20 psi (1.3 bar) do not continue to drive the vehicle.

Park your vehicle safely away from the roadway and contact the nearest authorized Mercedes-Benz Center or Roadside Assistance.

Have the damaged tire replaced.

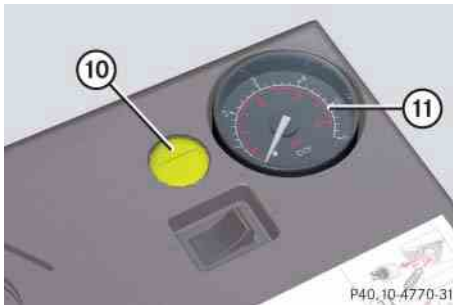

Version 2

- ⑩ Deflate button
- ⑪ Pressure gauge

- ▶ If the tire inflation pressure is at least 20 psi (1.3 bar), inflate or deflate the tire to correct tire inflation pressure (see Tire and Loading Information placard on the driver's door B-pillar):
 - ▶ To increase tire inflation pressure: Switch on the electric air pump.
 - ▶ To decrease tire inflation pressure (**version 1**): Open vent screw ⑩ on pressure gauge ⑪ (▷ page 455).
 - ▶ To decrease tire inflation pressure (**version 2**): Press yellow deflate button ⑩ located in air pump housing next to pressure gauge ⑪.

Warning!



Follow recommend inflation pressures.

Do not overinflate tires. Overinflating tires can result in sudden deflation (blowout) because they are more likely to become punctured or damaged by road debris, potholes, etc.

Do not underinflate tires. Underinflated tires wear unevenly, adversely affect handling and fuel economy, and are more likely to fail from being overheated.

Do not overload the tires by exceeding the specified vehicle capacity weight (as indicated by the label on the pillar in the driver's door opening). Overloading the tires can overheat them, possibly causing a blowout. ▷▷

Flat tire

- ▷▷▶ Drive to the nearest qualified workshop, e.g. an authorized Mercedes-Benz Center, to have the damaged tire replaced.

Recommended duration of use:

A maximum of 300 miles (500 km) at 50 mph (80 km/h) or below with the recommended tire inflation pressure.

- ▶ Contact an authorized Mercedes-Benz Center as soon as possible to obtain a new TIREFIT kit.
- ▶ Bring used TIREFIT materials to an authorized Mercedes-Benz Center for proper disposal.
- ▶ Replace your TIREFIT container every 4 years. Replacement containers are available at your authorized Mercedes-Benz Center.

Mounting the Minispare wheel

Warning!



The dimensions of the Minispare wheel is different from those of the road wheels. As a result, the vehicle handling characteristics change when driving with a Minispare wheel mounted. Adapt your driving style accordingly.

The Minispare wheel is for temporary use only. When driving with a Minispare wheel mounted, ensure proper tire pressure and do not exceed a vehicle speed of 50 mph (80 km/h).

Drive to the nearest Mercedes-Benz Center as soon as possible to have the Minispare wheel replaced with a regular road wheel.

Never operate the vehicle with more than one Minispare wheel mounted.

Do not switch off the ESP[®] when a Minispare wheel is mounted.

Preparing the vehicle

Prepare the vehicle as described (▷ page 452).

- ▶ Take the wheel wrench, alignment bolt, collapsible wheel chock, and the jack out of the trunk (▷ page 422).
- ▶ Take the Minispare wheel and wheel bolts out of the trunk (▷ page 425).

Lifting the vehicle

- ▶ Prevent the vehicle from rolling away by blocking wheels with wheel chocks or other sizeable objects.

One wheel chock is included with the vehicle tool kit (▷ page 422).

When changing wheel on a level surface:

- ▶ Place the wheel chock in front of and another sizeable object behind the wheel that is diagonally opposite to the wheel being changed.

Always try lifting the vehicle using the jack on a level surface. However, should circumstances require you to do so on a hill, place the wheel chock and the other sizeable object as follows:

- ▶ Place the wheel chock and another sizeable object on the downhill side blocking both wheels of the axle not being worked on.

Warning!



The jack is designed exclusively for jacking up the vehicle at the jack take-up brackets built into both sides of the vehicle. To help avoid personal injury, use the jack only to lift the vehicle during a wheel change. Never get beneath the vehicle while it is supported by the jack. Keep hands and feet away from the area under the lifted vehicle. Always firmly set parking brake and block wheels before raising vehicle with jack.

Do not disengage parking brake while the vehicle is raised. Be certain that the jack is always vertical (plumb line) when in use, especially on hills. Always try to use the jack on level surface. Make sure the jack arm is fully seated in the jack take-up bracket. Always lower the vehicle onto sufficient capacity jackstands before working under the vehicle.

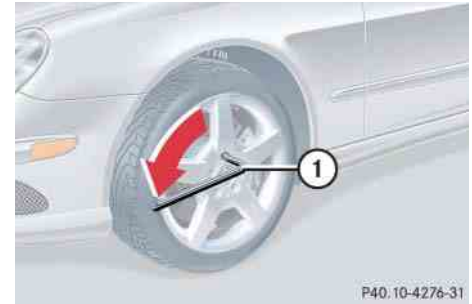

① Wheel wrench

- ▶ On wheel to be changed, loosen but do not yet remove the wheel bolts (approximately one full turn with wrench ①).

The jack take-up brackets are located directly behind the front wheel housings and in front of the rear wheel housings.

Flat tire



② Jack

③ Take-up bracket

- ▶ Place jack ② on firm ground.
- ▶ Position jack ② under take-up bracket ③ so that it is always vertical (plumb-line) as seen from the side, even if the vehicle is parked on an incline.

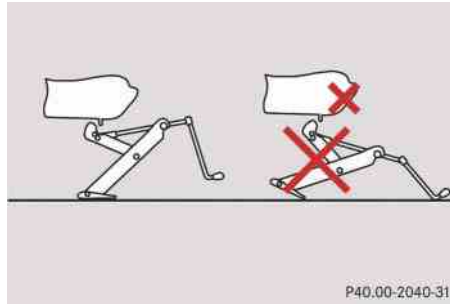

- ▶ Jack up the vehicle until the wheel is a maximum of 1.2 in (3 cm) from the ground. Never start engine while vehicle is raised.

Warning!



The jack is intended only for lifting the vehicle briefly for wheel changes. It is not suited for performing maintenance work under the vehicle.

- Never start the engine when the vehicle is raised.
- Never lie down under the raised vehicle.

Removing the wheel



① Alignment bolt

- ▶ Unscrew upper-most wheel bolt and remove.
- ▶ Replace this wheel bolt with alignment bolt ① supplied in the tool kit.
- ▶ Remove the remaining bolts.
- ▶ **!** Do not place wheel bolts in sand or dirt. This could result in damage to the bolts and wheel hub threads.
- ▶ Remove the wheel.

Mounting the Minispare wheel

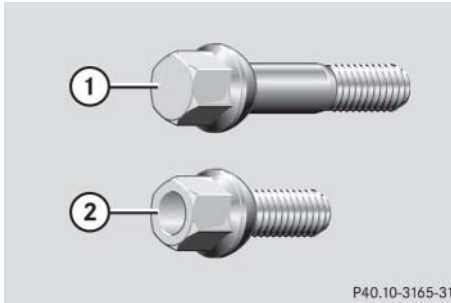

- ① Wheel bolt for light alloy rims
- ② Wheel bolt for Minispare wheel, (located in trunk with Minispare wheel)

! Wheel bolts ② must be used when mounting the Minispare wheel. The use of any wheel bolts other than wheel bolts ② for the Minispare wheel will physically damage the vehicle's brakes.

- ▶ Clean contact surfaces of wheel and wheel hub.

! To avoid paint damage, place wheel flat against hub and hold it there while installing first wheel bolt.

Warning!



Always replace wheel bolts that are damaged or rusted.

Never apply oil or grease to wheel bolts.

Damaged wheel hub threads should be repaired immediately. Do not continue to drive under these circumstances! Contact an authorized Mercedes-Benz Center or call Roadside Assistance.

Incorrect wheel bolts or improperly tightened wheel bolts can cause the wheel to come off. This could cause an accident. Make sure to use the correct wheel bolts.



- ① Alignment bolt
- ▶ Guide spare wheel onto the alignment bolt and push it on.
- ▶ Insert wheel bolts and tighten them slightly.



Flat tire



- ▶ Unscrew the alignment bolt, install last wheel bolt and tighten slightly.

Warning!



Only use genuine Mercedes-Benz wheel bolts. Other wheel bolts may come loose.

Do not tighten the wheel bolts when the vehicle is raised. Otherwise the vehicle could fall off the jack.

Lowering the vehicle

- ▶ Lower vehicle by turning crank counterclockwise until vehicle is resting fully on its own weight.
- ▶ Remove the jack.

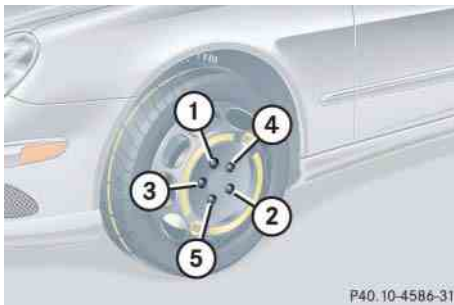

① - ⑤ Wheel bolts

- ▶ Tighten the five wheel bolts evenly, following the diagonal sequence illustrated (① to ⑤), until all bolts are tight. Observe a tightening torque of 80 lb-ft (110 Nm).

Warning!



Have the tightening torque checked after changing a wheel. The wheels could come loose if they are not tightened to a torque of 80 lb-ft (110 Nm).

Before storing the jack, it should be fully collapsed, with handle folded in (storage position) (▷ page 424).

- ▶ Store the jack and the other vehicle tools in the trunk.

MOExtended system*

The MOExtended system allows you to continue driving your vehicle even if there is a total loss of pressure in one or more tires.

You may only use the MOExtended system in conjunction with the Run Flat Indicator.

! *The maximum distance in emergency mode depends on the vehicle's load. It is 30 miles (50 km) if the vehicle is partially loaded and 18 miles (30 km) if the vehicle is fully loaded.*

The point at which the maximum driving distance begins in emergency mode is when the warning message appears in the multifunction display indicating that there is a loss of tire inflation pressure.

Do not exceed the maximum speed of 50 mph (80 km/h).

Warning!

In emergency mode, your vehicle's driving characteristics are diminished in such situations as:

- driving around curves
- while braking
- while accelerating rapidly

Therefore, your driving style must be adapted accordingly. Avoid abrupt steering and driving maneuvers, as well as driving over obstacles (road curbs, potholes, or off-road areas). This is especially important if the vehicle is heavily loaded.

The emergency driving distance that can be achieved greatly depends on the demands placed on the vehicle. Depending on speed, load, driving maneuvers, road conditions, outside temperature, etc., the distance can be significantly shorter or, if the vehicle is driven cautiously, somewhat longer.

Do not continue driving in emergency mode if

- you notice knocking sounds
- the vehicle starts to shake
- smoke develops and you smell rubber
- ESP® is intervening continuously
- you notice tears on the tire sidewalls

After driving in emergency mode, you must have the rims inspected at an authorized Mercedes-Benz Center to check if they are suitable for further use. The failed tire must be replaced in any case.

i *When replacing individual or all tires on the vehicle, make sure only matching tires marked with "MOExtended" are mounted in the size specified for your vehicle (▷ page 482).*

Battery

The battery is located in the engine compartment on the right hand side.

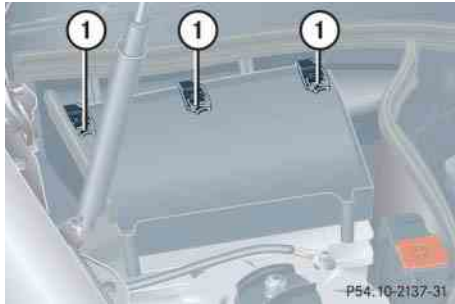

① Clamps

Removing filter box:

- ▶ Release clamps ①.
- ▶ Remove filter box.

Installing filter box:

- ▶ Insert filter box properly.
- ▶ Secure it with clamps ①.

Warning!



Failure to follow these instructions can result in severe injury or death.

Observe all safety instructions and precautions when handling automotive batteries (▷ page 329).

Never lean over batteries while connecting, you might get injured.

Battery fluid contains sulfuric acid. Do not allow this fluid to come in contact with eyes, skin or clothing. In case it does, immediately flush affected area with water and seek medical help if necessary.

A battery will also produce hydrogen gas, which is flammable and explosive. Keep flames or sparks away from battery, avoid improper connection of jumper cables, smoking, etc.

! Never loosen or detach battery terminal clamps while the engine is running or the SmartKey is in the starter switch. Otherwise the alternator and other electronic components could be severely damaged.

Have the battery checked regularly at an authorized Mercedes-Benz Center.

Refer to Maintenance Booklet for maintenance intervals or contact an authorized Mercedes-Benz Center for further information.

Warning!



Do not place metal objects on the battery as this could result in a short circuit.

Use leak-proof battery only to avoid the risk of acid burns in the event of an accident.

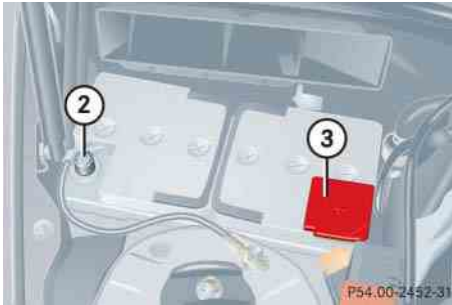

- ② Negative terminal
- ③ Positive terminal cover

Disconnecting the battery

Warning!



With a disconnected battery

- you will no longer be able to turn the SmartKey in the starter switch and pressing the KEYLESS-GO* start/stop button on the gear selector lever will have no effect
- the gear selector lever will remain locked in position **P**

! Always disconnect the battery in the order described below. Otherwise the vehicle's electronics can be damaged.

- ▶ Apply the parking brake (▷ page 59).
- ▶ Make sure gear selector lever is set to position **P** (▷ page 174).
- ▶ Turn off all electrical consumers.
- ▶ Remove SmartKey from starter switch.

Vehicles with KEYLESS-GO*:

- ▶ Press the start / stop button until the engine shuts off.
- ▶ Open the driver's door.
- ▶ Open the hood (▷ page 323).
- ▶ Remove the filter box (▷ page 464).
- ▶ Read and observe safety instructions and precautions (▷ page 464).
- ▶ Disconnect the battery negative lead from negative terminal ②.
- ▶ Remove cover ③ from the positive terminal.
- ▶ Disconnect the battery positive lead.

Removing the battery

- ▶ Remove the screw securing the battery.
- ▶ Remove the battery support and bracket.
- ▶ Pull out the ventilation hose from the battery (depending on battery arrangement in your vehicle model, the ventilation hose is located either on the left or right side of the battery).
- ▶ Take out the battery.

Battery

Charging and reinstalling the battery

Warning!



Never charge a battery while still installed in the vehicle unless the accessory battery charge unit approved by Mercedes-Benz is being used. Gases may escape during charging and cause explosions that may result in paint damage, corrosion or personal injury.

An accessory battery charge unit specially adapted for Mercedes-Benz vehicles and tested and approved by Mercedes-Benz is available, permitting the charging of the battery in its installed position. Contact an authorized Mercedes-Benz Center for information and availability. Charge battery in accordance with the separate instructions for the accessory battery charger.

- ▶ Charge battery in accordance with the instructions of the battery charger manufacturer.

- ▶ Reinstall the charged battery. Follow the previously described steps in reverse order.

! *The battery, its filler caps and the ventilation hose must always be securely installed when the vehicle is in operation.*

Reconnecting the battery

! *Always connect the battery in the order described below. Otherwise the vehicle's electronics can be damaged.*

- ▶ Turn off all electrical consumers.
- ▶ Remove SmartKey from starter switch.
Vehicles with KEYLESS-GO*:
 - ▶ Open the driver's door.

! *Never invert the terminal connections!*

- ▶ Connect the battery positive lead and fasten its cover ③ (▷ page 465).
- ▶ Connect the battery negative lead ② (▷ page 465).
- ▶ Reinstall the filter box (▷ page 464).

i *The following procedures must be carried out following any interruption of battery power (e.g. due to reconnecting):*

- *Set the clock (▷ page 160). Vehicles with COMAND*: see COMAND operator's manual.*
- *Synchronize the side windows (▷ page 252).*
- *Synchronize the tilt/sliding sunroof* (CLK coupe) (▷ page 258).*

Batteries contain materials that can harm the environment if disposed of improperly. Large 12-volt storage batteries contain lead. Recycling of batteries is the preferred method of disposal. Many states require sellers of batteries to accept old batteries for recycling.

▼ Jump starting

Warning!



Failure to follow these directions will cause damage to the electronic components, and can lead to a battery explosion and severe injury or death.

Never lean over batteries while connecting or jump starting, you might get injured.

Battery fluid contains sulfuric acid. Do not allow this fluid to come in contact with eyes, skin or clothing. In case it does, immediately flush affected area with water, and seek medical help if necessary.

A battery will also produce hydrogen gas, which is flammable and very explosive. Keep flames or sparks away from battery, avoid improper connection of jumper cables, smoking, etc.

Attempting to jump start a frozen battery can result in it exploding, causing personal injury.

Read all instructions before proceeding.

! Do not tow-start the vehicle.

! Avoid repeated and lengthy starting attempts.

Do not attempt to start the engine using a battery quick charge unit.

If the engine does not run after several unsuccessful starting attempts, have it checked at the nearest authorized Mercedes-Benz Center.

Excessive unburned fuel generated by repeated failed starting attempts may damage the catalytic converter and may present a fire risk.

Make sure the jumper cables do not have loose or missing insulation.

Make sure the cable clamps do not touch any other metal part while the other end is still attached to a battery.

If the battery is discharged, the engine can be started with jumper cables and the battery of another vehicle. Observe the following:

- Jump starting should only be performed when the engine and catalytic converter are cold.

- Do not start the engine if the battery is frozen. Let the battery thaw out first.
- Only jump start from batteries with the same voltage rating (12 V). Jump starting with a higher voltage battery could damage the vehicle's electrical system, which will not be covered by the Mercedes-Benz Limited Warranty.
- Only use jumper cables with sufficient cross-section and insulated terminal clamps.
- Always make sure the jumper cables are not on or near pulleys, fans or other parts that move when an engine is started or running.

Warning!



Keep flames or sparks away from battery. Do not smoke.

Observe all safety instructions and precautions when handling automotive batteries (▷ page 329).

Jump starting

The battery is located on the right side of the engine compartment. For jump starting, use the terminals in front of the battery.

- ▶ Make sure the two vehicles do not touch.
- ▶ Turn off all electrical consumers.
- ▶ Apply the parking brake (▷ page 59).
- ▶ Make sure the gear selector lever is set to position **P** (▷ page 174).
- ▶ Open the hood (▷ page 323).
- ▶ Flip up cover from positive under hood terminal ② in front of the filter box (▷ page 465).

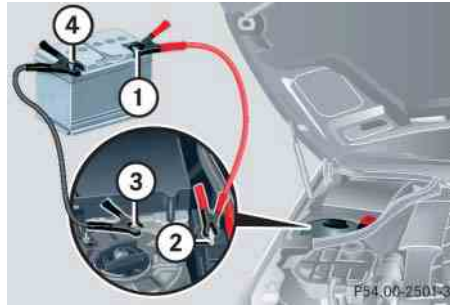

- ① Positive terminal of charged battery
- ② Positive under hood terminal in front of discharged battery
- ③ Negative under hood terminal in front of discharged battery
- ④ Negative terminal of charged battery

! *Never invert the terminal connections.*

- ▶ Connect the positive terminal ① of the charged battery with the positive under hood terminal ② in front of the filter box with the jumper cable. Clamp cable to charged battery ① first.
- ▶ Start engine of the vehicle with the charged battery and run at idle speed.

- ▶ Connect the negative terminal ④ of the charged battery with the negative under hood terminal ③ in front of the filter box with the second jumper cable. Clamp the cable to the negative terminal ④ of the charged battery first.
- ▶ Start the engine of the disabled vehicle.

You can now turn on the electrical consumers. Do not switch on the headlamps under any circumstances.

- ▶ Remove the jumper cables first from the negative terminals ③ and ④ and then from the positive terminals ② and ①.

You can now switch on the headlamps.

- ▶ Have the battery checked at the nearest authorized Mercedes-Benz Center.

▼ Towing the vehicle

Towing the vehicle

Mercedes-Benz recommends that the vehicle be transported with all wheels off the ground using flatbed or appropriate wheel lift/dolly equipment.

! *Do not tow-start the vehicle.*

! *Use flatbed or wheel lift/dolly equipment with SmartKey in starter switch turned to position 0.*

Do not tow with sling-type equipment. Towing with sling-type equipment over bumpy roads will damage radiator and supports.

To prevent damage during transport, do not tie down vehicle by its chassis or suspension parts.

Switch off the automatic central locking (▷ page 166).

When circumstances do not permit the recommended towing methods, the vehicle may be towed with all wheels on the ground or front wheels raised only so far as necessary to have the vehicle moved to a safe location where the recommended towing methods can be employed.

Warning!



If circumstances require towing the vehicle with all wheels on the ground, always tow with a tow bar if:

- the engine will not run
- there is a malfunction in the brake system
- there is a malfunction in the power supply or in the vehicle's electrical system

This is necessary to adequately control the towed vehicle.

Prior to towing the vehicle with all wheels on the ground, make sure the SmartKey is in starter switch position **2**.

If the SmartKey is left in starter switch position **0** for an extended period of time, it can no longer be turned in the switch. In this case, the steering is locked. To unlock, remove SmartKey from starter switch and reinsert.

Warning!



With the engine not running, there is no power assistance for the brake and steering systems. In this case, it is important to keep in mind that a considerably higher degree of effort is necessary to brake and steer the vehicle. Adapt your driving accordingly.

! *If the vehicle is towed with the front axle raised, the gear selector lever must be in position **N** and the engine must be shut off (SmartKey in starter switch position **0** or **1**). Active braking action through the ESP® may otherwise seriously damage the brake system.*

*When towing the vehicle with all wheels on the ground, the gear selector lever must be in position **N** and the SmartKey must be in starter switch position **2**.*

When towing the vehicle with all wheels on the ground or the front axle raised, the vehicle may be towed only for distances up to 30 miles (50 km) and at a speed not to exceed 30 mph (50 km/h).

Towing the vehicle

! Towing of the vehicle should only be done using the properly installed towing eye bolt. Never attach tow cable, tow rope or tow rod to the vehicle chassis, frame or suspension parts.

i When towing the vehicle with all wheels on the ground, please note the following:

With the automatic central locking activated and the SmartKey in starter switch position **2**, or KEYLESS-GO* start/stop button in position **2**, the vehicle doors lock if the left front wheel as well as the right rear wheel are turning at vehicle speeds of approximately 9 mph (15 km/h) or more.

To prevent the vehicle door locks from locking, deactivate the automatic central locking (▷ page 166).

i To signal turns while being towed with the hazard warning flasher in use, switch on the ignition and activate the combination switch for the left or right turn signal in the usual manner – only the selected turn signal will operate.

Upon canceling the turn signal, the hazard warning flasher will operate again.

i If the battery is disconnected or discharged

- the SmartKey will not turn in the starter switch. For more information, see “Battery” (▷ page 464) and “Jump starting” (▷ page 467).
- the gear selector lever will remain locked in position **P**. For information on manually unlocking the transmission gear selector lever, see (▷ page 429).

Installing towing eye bolt

Towing eye bolt CLK 350

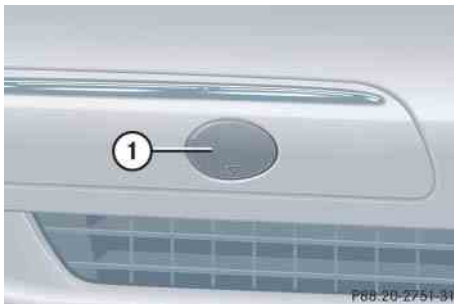

① Cover on right side of front bumper

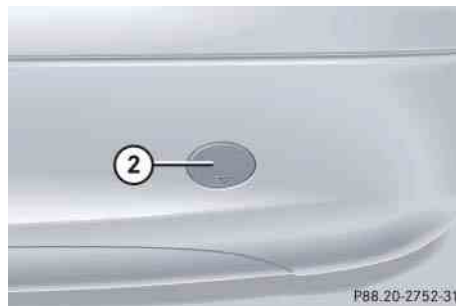

② Cover on right side of rear bumper

To remove cover:

- ▶ Press mark on cover ① or ②.
- ▶ Lift cover off to reveal the threaded hole for towing eye bolt.

The towing eye bolt is supplied with the tool kit (located in the compartment underneath the trunk floor).

- ▶ Screw towing eye bolt in to its stop and tighten with wheel wrench.

To reinstall cover:

- ▶ Fit cover ① or ② and snap into place.

Towing eye bolt CLK 550/CLK 63 AMG

Towing eye bolt in front bumper

The cover for the towing eye bolt in the front bumper is identical to the cover on the CLK 350.

To remove and to reinstall cover, see “Towing eye bolt CLK 350” (▷ page 470).

Towing eye bolt in rear bumper

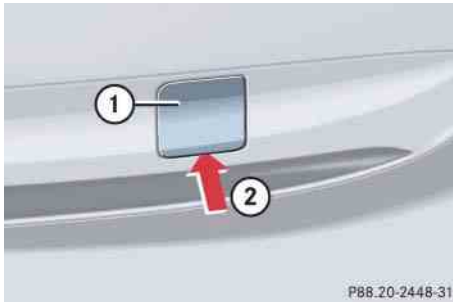

- ① Cover on right side of rear bumper
- ② Recess in the cover

To remove cover ①:

- ▶ Insert flat, blunt object as a lever in recess ② on the edge of cover ①.
- ▶ Loosen cover ① from the bumper using lever, to reveal the threaded hole for towing eye bolt.

The towing eye bolt is supplied with the tool kit (located in the compartment underneath the trunk floor).

- ▶ Screw towing eye bolt in to its stop and tighten with wheel wrench.

To reinstall cover ①:

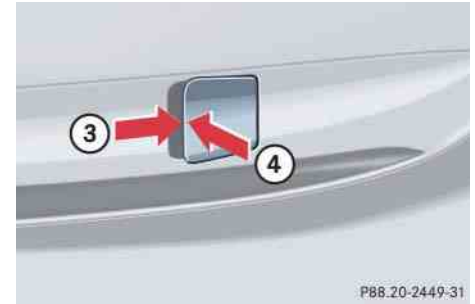

- ▶ Hook right-hand side of the cover ① into opening.
- ▶ Slide cover ① as far as it will go in the direction of the arrow ③.
- ▶ Gently press left-hand side of cover ① in direction of the arrow ④.

The hooks on the left-hand side engage.

i When closing the cover ①, make sure the cover's check strap does not get caught.

Fuses

The electrical fuses in your vehicle serve to switch off malfunctioning power circuits.

If a fuse is blown, the components and systems secured by that fuse will stop operating.

Warning!



Only use fuses approved by Mercedes-Benz with the specified amperage for the system in question and do not attempt to repair or bridge a blown fuse. Using other than approved fuses or using repaired or bridged fuses may cause an overload leading to a fire, and/or cause damage to electrical components and/or systems. Have the cause determined and remedied at an authorized Mercedes-Benz Center.

i A blown fuse must be replaced by an appropriate spare fuse (recognizable by its color or the fuse rating given on the fuse) of the amperage recommended in the fuse chart. Any Mercedes-Benz Center will be glad to advise you on this subject.

If a newly inserted fuse blows again, have the cause determined and rectified at an authorized Mercedes-Benz Center.

A fuse chart explains the fuse allocation and fuse amperages. It is located in the main fuse box in the passenger compartment (▷ page 472).

i In case of a blown fuse contact Roadside Assistance or an authorized Mercedes-Benz Center.

The electrical fuses are located in different fuse boxes:

- in the passenger compartment on the driver's side (▷ page 472)
- on the driver's side of the engine compartment (▷ page 473)
- in the trunk (▷ page 474)

Before replacing fuses:

- ▶ Apply the parking brake (▷ page 59).
- ▶ Make sure the gear selector lever is set to position **P** (▷ page 174).
- ▶ Turn off all electrical consumers.

- ▶ Turn off the engine (▷ page 60).
- ▶ Remove the SmartKey from the starter switch.

Vehicles with KEYLESS-GO*:

- ▶ Open the driver's door.

Fuse box in passenger compartment

The fuse box is located in the passenger compartment on the driver's side of the cockpit.

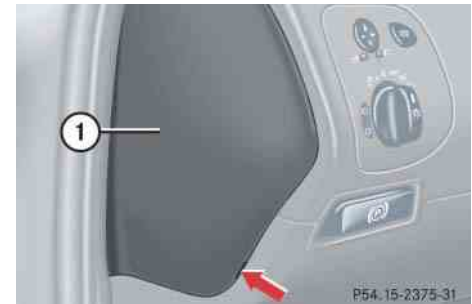

① Fuse box cover

! Do not use sharp objects such as a screw driver to open the fuse box cover ① in the cockpit, as this could damage it.

Opening fuse box

- ▶ Open the driver's door.
- ▶ Insert flat, blunt object as a lever into the edge of the fuse box cover ① at the position indicated by the arrow.
- ▶ Loosen fuse box cover ① from cockpit using lever.
- ▶ Using your hands, remove fuse box cover ① rearward.

Closing fuse box

- ▶ Attach fuse box cover ① in the front.
- ▶ Fold fuse box cover ① in until it engages.

Fuse box in engine compartment

The fuse box is located in the engine compartment on the driver's side.

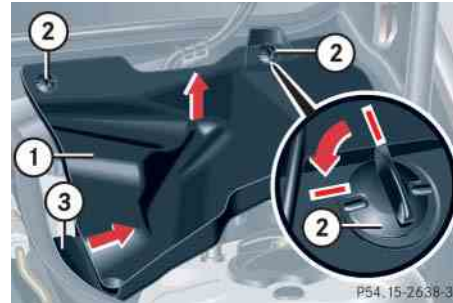

- ① Cover
- ② Screw
- ③ Retainer

Removing cover

- ▶ Twist screws ② 90° counterclockwise.
- ▶ Lift the rear of cover ①.
- ▶ Slide out retainer ③ and remove cover ① by pulling towards front.

Opening fuse box

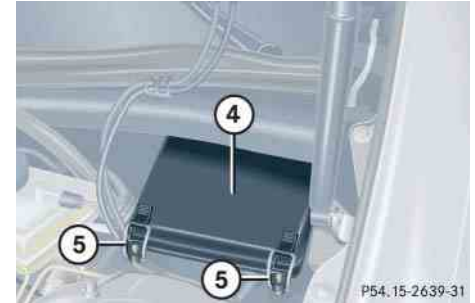

- ④ Fuse box cover
- ⑤ Clamps

- ▶ With a dry cloth, remove any moisture from the fuse box.
- ▶ Release clamps ⑤.
- ▶ Remove fuse box cover ④.

Fuses

Closing fuse box

- ▶ Make sure the sealing rubber is properly positioned.
- ▶ Press fuse box cover ④ down and secure with clamps ⑤.

! The fuse box cover ④ must be properly positioned as described to prevent moisture or dirt from entering the fuse box and possibly impairing fuse operation.

Installing cover

- ▶ Insert cover ① sideways into retainer ③.
- ▶ Twist screws ② 90° clockwise.

Fuse box in trunk

CLK coupe

The fuse box is located in the trunk behind the left-hand trim panel.

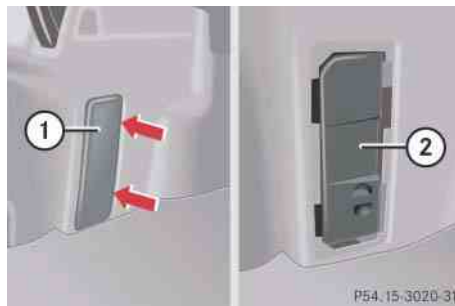

- ① Trim panel
- ② Fuse box cover

Opening fuse box

- ▶ Pull away trim panel ①.
- ▶ Remove fuse box cover ②.

Closing fuse box

- ▶ Place fuse box cover ② back on.

- ▶ Press trim panel ① back into place.

CLK cabriolet

The fuse box is located in the trunk behind the left-hand trim panel.

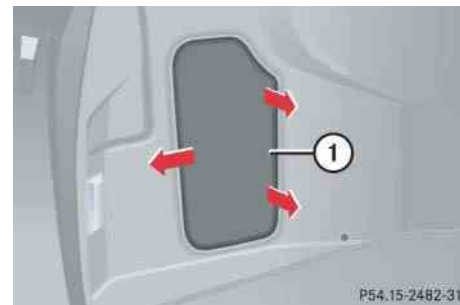

- ① Trim panel

Opening fuse box

- ▶ To open, pull trim panel ① in the direction of the rear light and outward.

Closing fuse box

- ▶ Press trim panel ① back into place.

Parts service

Warranty coverage

Identification labels

Layout of poly-V-belt drive

Engine

Rims and tires

Electrical system

Main dimensions and weights

Fuels, coolants, lubricants, etc.



The “Technical data” section provides the necessary technical data for your vehicle.

All authorized Mercedes-Benz Centers maintain a stock of Genuine Mercedes-Benz Parts required for maintenance and repair work. In addition, strategically located parts distribution centers provide quick and reliable parts service.

More than 300 000 different parts for Mercedes-Benz models are available.

Genuine Mercedes-Benz Parts are subjected to stringent quality inspections. Each part has been specifically developed, manufactured or selected for and adapted to Mercedes-Benz vehicles.

Therefore, Genuine Mercedes-Benz parts should be installed.

! *The use of non-genuine Mercedes-Benz parts and accessories not authorized by Mercedes-Benz could damage the vehicle, which is not covered by the Mercedes-Benz Limited Warranty, or could compromise the vehicle's durability or safety.*

▼ Warranty coverage

Your vehicle is covered under the terms of the warranties printed in the Service and Warranty Information booklet. Your authorized Mercedes-Benz Center will exchange or repair any defective parts originally installed in the vehicle in accordance with the terms of the following warranties:

- New Vehicle Limited Warranty
- Emission System Warranty
- Emission Performance Warranty
- California, Maine, Massachusetts, and Vermont Emission Control Systems Warranty

Replacement parts and accessories are covered by the Mercedes-Benz Parts and Accessories warranties, copies of which are available at any Mercedes-Benz Center.

Loss of Service and Warranty Information Booklet

Should you lose your Service and Warranty Information booklet, have an authorized Mercedes-Benz Center arrange for a replacement. It will be mailed to you.

Identification labels



① Certification label (on driver's B-pillar)

The Vehicle Identification Number (VIN) can be found in the following locations:

- on the certification label.
- embossed underneath the carpet in front of the passenger seat (▷ page 479).
- on the lower edge of the windshield (▷ page 479).

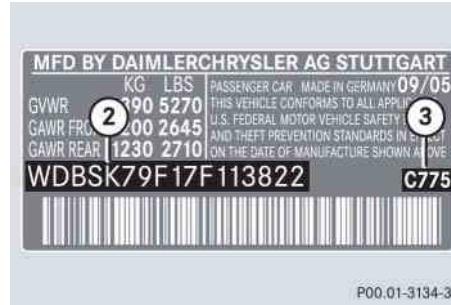

Example certification label (U.S. vehicles)

- ② VIN
- ③ Paintwork code



Example certification label (Canada vehicles)

- ② VIN
- ③ Paintwork code

i Data shown on certification label are for illustration purpose only. These data are specific to each vehicle and may vary from data shown in the illustration. Refer to certification label on vehicle for actual data specific to your vehicle.



- ④ Carpet
- ⑤ VIN

- ▶ Move the passenger seat to the rear as far as possible.
 - ▶ Fold carpet ④ in direction of arrow.
- VIN ⑤ is visible.

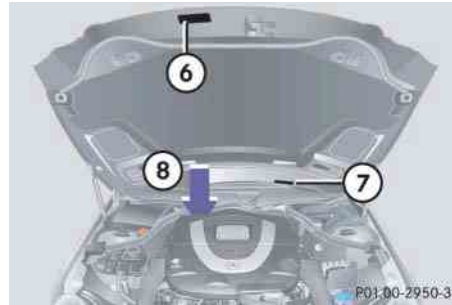

- ⑥ Emission control information label, includes both federal and California certification exhaust emission standards
- ⑦ VIN (lower edge of windshield)
- ⑧ Engine number (engraved on engine)

i When ordering parts, please specify vehicle identification and engine numbers.

Layout of poly-V-belt drive

CLK 350 / CLK 550

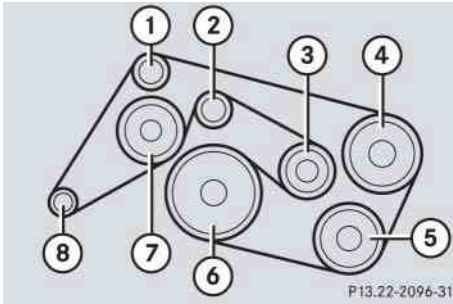

- ① Idler pulley
- ② Idler pulley
- ③ Automatic belt tensioner
- ④ Power steering pump
- ⑤ Air conditioning compressor
- ⑥ Crankshaft
- ⑦ Coolant pump
- ⑧ Generator (alternator)

CLK 63 AMG

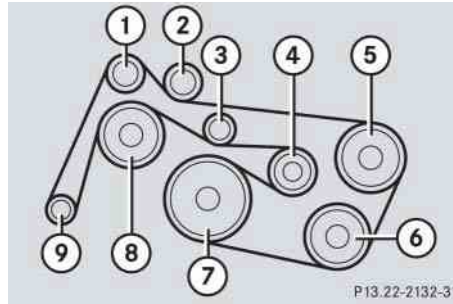

- ① Idler pulley
- ② Idler pulley
- ③ Idler pulley
- ④ Automatic belt tensioner
- ⑤ Power steering pump
- ⑥ Air conditioning compressor
- ⑦ Crankshaft
- ⑧ Coolant pump
- ⑨ Generator (alternator)

▼ Engine

Model	Coupe	CLK 350 (209.356) ¹	CLK 550 (209.372) ¹	CLK 63 AMG (209.477) ¹
	Cabriolet	CLK 350 (209.456) ¹	CLK 550 (209.472) ¹	
Engine		272	273	156
Mode of operation		4-stroke engine, gasoline injection	4-stroke engine, gasoline injection	4-stroke engine, gasoline injection
No. of cylinders		6	8	8
Bore		3.66 in (92.90 mm)	3.85 in (98.00 mm)	4.02 in (102.20 mm)
Stroke		3.39 in (86.00 mm)	3.56 in (90.50 mm)	3.72 in (94.60 mm)
Total piston displacement		213.5 cu in (3498 cm ³)	333.25 cu in (5461 cm ³)	378.8 cu in (6208 cm ³)
Compression ratio		10.5:1	10.5:1	11.3:1
Output acc. to SAE J 1349		268 hp / 6 000 rpm ² (200 kW / 6 000 rpm)	382 hp / 6 000 rpm ² (285 kW / 6 000 rpm)	475 hp / 6 800 rpm ² (354 kW / 6 800 rpm)
Maximum torque acc. to SAE J 1349		258 lb-ft / 2 400 - 5 000 rpm (350 Nm / 2 400 - 5 000 rpm)	391 lb-ft / 2 800 - 4 800 rpm (530 Nm / 2 800 - 4 800 rpm)	465 lb-ft / 5 000 rpm (630 Nm / 5 000 rpm)
Maximum engine speed		6 300 rpm	6 500 rpm	7 200 rpm
Firing order		1-4-3-6-2-5	1-5-4-2-6-3-7-8	1-5-4-2-6-3-7-8
Poly-V-belt		2404 mm	2404 mm (CLK coupe) 2380 mm (CLK cabriolet)	2360 mm

¹ The quoted data apply only to the standard vehicle. See an authorized Mercedes-Benz Center for the corresponding data of all special bodies and special equipment.

² Premium fuel required. Performance may vary with fuel octane rating.

Rims and tires

! Only use tires which have been tested and approved for your vehicle by Mercedes-Benz. Tires approved by Mercedes-Benz are developed to provide best possible performance in conjunction with the driving safety systems on your vehicle such as ABS or ESP®. Tires specially developed for your vehicle and tested and approved by Mercedes-Benz can be identified by finding the following on the tire's sidewall:

- MO = Mercedes-Benz Original equipment tires
AMG vehicles:
Does not apply to all approved tires on AMG vehicles. For information on tested and approved tires for AMG vehicles, contact an authorized Mercedes-Benz Center.
- MOE = Mercedes-Benz Original Extended (tires with limited run-flat characteristics) original equipment tires

Using tires other than those approved by Mercedes-Benz may result in damage that is not covered by the Mercedes-Benz Limited Warranty.

i For information on driving with MOExtended tires, see "MOExtended system*" (▷ page 348).

! Using tires other than those approved by Mercedes-Benz can have detrimental effects, such as

- poor handling characteristics
- increased noise
- increased fuel consumption

Moreover, tires and rims not approved by Mercedes-Benz may, under load, exhibit dimensional variations and different tire deformation characteristics that could cause them to come into contact with the vehicle body or axle parts. Damage to the tires or the vehicle may be the result.





i Further information on tires and rims is available at any authorized Mercedes-Benz Center. A placard with the recommended tire inflation pressures is located on the driver's door B-pillar. Some vehicles may have supplemental tire inflation pressure information for driving at high speeds (▷ page 340) or for vehicle loads less than the maximum loaded vehicle condition (▷ page 339).

If such information is provided, it can be found on the placard located on the inside of the fuel filler flap. The tire inflation pressure should be checked regularly and should only be adjusted on cold tires. Follow tire manufacturer's maintenance recommendation included with vehicle.

i The following pages also list the approved wheel rim and tire sizes for equipping your vehicles with winter tires. Winter tires are not available as standard or optional factory equipment, but can be purchased from an authorized Mercedes-Benz Center.

Depending on vehicle model and the standard or optional factory-equipped wheel rim/tire configuration on your vehicle (Appearance Package, Sport Package etc.), equipping your vehicle with winter tires approved for your vehicle model may also require the purchase of two or four wheel rims of the recommended size for use with these winter tires. See an authorized Mercedes-Benz Center for more information.

Same size tires

Model	CLK 350	CLK 550
Rims (light alloy)	7.5 J x 17 H2	7.5 J x 17 H2
Wheel offset	1.42 in (36 mm)	1.42 in (36 mm)
Winter tires^{1,3}	225/45 R17 91 H M+S 	225/45 R17 91 H M+S 
Winter tires^{1,2,3}	225/45 R17 91 H M+S  <i>MOExtended</i>	225/45 R17 91 H M+S  <i>MOExtended</i>

¹ Radial-ply tires

² Must be used in conjunction with Tire Pressure Monitoring System (U.S. vehicles) or Run Flat Indicator (Canada vehicles) only.

³ Not available as factory equipment.

Model	CLK 63 AMG cabriolet
Rims (light alloy)	8 J x 18 H2
Wheel offset	1.34 in (34 mm)
Winter tires^{1,2,3}	225/40 R18 92 V XL (Extra Load) M+S 

¹ Radial-ply tires

² Not available as factory equipment.

³ For use with snow chains contact an authorized Mercedes-Benz Center.

Rims and tires

Mixed size tires

Model	CLK 350	CLK 550*
Front axle:		
Rims (light alloy)	7.5 J x 17 H2	7.5 J x 17 H2
AMG rims (light alloy)	-	-
Wheel offset	1.42 in (36 mm)	1.42 in (36 mm)
All-season tires ¹	225/45 R17 91H	-
Summer tires ^{* 1,2}	225/45 R17 91W MO <i>Extended</i>	225/45 R17 91W MO <i>Extended</i>
Rear axle:		
Rims (light alloy)	8.5 J x17 H2	8.5 J x17 H2
AMG rims (light alloy)	-	-
Wheel offset	1.18 in (30 mm)	1.18 in (30 mm)
All-season tires ^{1,3}	245/40 R17 91H	-
Summer tires ^{* 1,2,3}	245/40 R17 91W MO <i>Extended</i>	245/40 R17 91W MO <i>Extended</i>

¹ Radial-ply tires

² Must be used in conjunction with Tire Pressure Monitoring System (U.S. vehicles) or Run Flat Indicator (Canada vehicles) only.

³ Must not be used with snow chains.

Model	CLK 550	CLK 63 AMG cabriolet
Front axle:		
AMG rims (light alloy)	7.5 J x 18 H2	8 J x 18 H2
Wheel offset	1.46 in (37 mm)	1.34 in (34 mm)
Summer tires¹	225/40 ZR18 92Y XL (Extra Load)	225/40 ZR18 92Y XL (Extra Load)
Rear axle:		
AMG rims (light alloy)	8.5 J x18 H2	8.5 J x18 H2
Wheel offset	1.18 in (30 mm)	1.18 in (30 mm)
Summer tires^{1,2}	255/35 ZR18 94Y XL (Extra Load)	255/35 ZR18 94Y XL (Extra Load)

¹ Radial-ply tires

² Must not be used with snow chains.

Rims and tires

Minispare wheel

Model	All Models (except CLK 63 AMG cabriolet)
Rim	3.5 B x 17 H2
Wheel offset	0.67 in (17 mm)
Tire ¹	T 125/80 R 17 99M

¹ Must not be used with snow chains.

! Please compare the recommended tire inflation pressure for your vehicle with the tire inflation pressure on the yellow label located on the spare wheel rim.

If the tire inflation pressure on the yellow label on the spare wheel rim differs from the values given in this Operator's Manual, inflate the spare wheel tire to the recommended tire inflation pressure given on the yellow label on the spare wheel rim.

i Please note that the tire inflation pressure of the Minispare tire differs from the tire inflation pressure of the road tires.

Make sure the Minispare tire is inflated to approximately 61 psi (4.2 bar).

i The CLK 63 AMG cabriolet does not have a spare wheel. The CLK 63 AMG cabriolet is equipped with TIREFIT, see "Sealing tires with TIREFIT (CLK 63 AMG only)" (▷ page 452).

▼ Electrical system

Model	CLK 350	CLK 550	CLK 63 AMG
Generator (alternator)	14 V/150 A	14 V/180 A	14 V/180 A
Starter motor	12 V/1.4 KW	12 V/1.7 KW	12 V/2.2 KW
Battery	12 V/100 Ah	12 V/100 Ah	12 V/100 Ah
Spark plugs	Bosch Platin Y 7 MPP 33 NGK PLKR 6A	Bosch F8 DPP 332 NGK PFR 5R-11	NGK ILZKAR 7A10
Electrode gap	0.031 in (0.80 mm)	0.039 in (1.00 mm)	0.039 in (1.0 mm)
Tightening torque	15 - 22 lb-ft (20 - 30 Nm)	18.5 - 22 lb-ft (25 - 30 Nm)	14.75 - 18.5 lb-ft (20 - 25 Nm)

Main dimensions and weights

Main dimensions

Model	CLK 350	CLK 550	CLK 63 AMG
Overall vehicle length	183.3 in (4 657 mm)	183.3 in (4 657 mm)	183.3 in (4 657 mm)
Overall vehicle width (exterior rear view mirrors folded out)	78.4 in (1 991 mm)	78.4 in (1 991 mm)	78.4 in (1 991 mm)
Overall vehicle height			
Coupe:	55.4 in (1 408 mm)	55.4 in (1 408 mm)	
Cabriolet:	55.6 in (1 413 mm)	55.4 in (1 408 mm)	55.3 in (1 400 mm)
Overall vehicle height when opening/closing soft top	80.2 in (2 038 mm)	81.0 in (2 057 mm)	80.6 in (2 047 mm)
Wheelbase	106.9 in (2 715 mm)	106.9 in (2 715 mm)	106.9 in (2 715 mm)
Track, front	58.8 in (1 493 mm)	58.9 in (1 497 mm)	58.9 in (1 495 mm)
Track, rear	58.0 in (1 474 mm)	58.2 in (1 478 mm)	58.0 in (1 474 mm)

Weights

Roof load max. (CLK coupe only)	220 lbs (100 kg)
Trunk load max.	220 lbs (100 kg)

Fuels, coolants, lubricants, etc.

▼ **Fuels, coolants, lubricants, etc.**

Capacities

Vehicle components and their respective lubricants must match. Therefore only use products tested and approved by Mercedes-Benz.

Please refer to the Factory Approved Service Products pamphlet (USA only), or inquire at an authorized Mercedes-Benz Center.

Warning!



Comply with all valid regulations with respect to handling, storing, and disposing of service fluids. Otherwise you could endanger persons or the environment.

Keep service fluids out of the reach of children.

For health reasons, you should prevent service fluids from coming into direct contact with your skin and clothing.

If a service fluid is swallowed, contact a physician immediately.

	Model	Capacity	Fuels, coolants, lubricants, etc.
Engine with oil filter	CLK 350	8.5 US qt (8.0 l)	Approved engine oils
	CLK 550	9.0 US qt (8.5 l)	
	CLK 63 AMG	9.3 US qt (8.8 l)	
Automatic transmission	CLK 350	9.0 US qt (8.5 l)	MB Automatic Transmission Fluid
	CLK 550	9.5 US qt (9.0 l)	
	CLK 63 AMG	9.2 US qt (8.7 l)	
Rear axle	CLK 350	1.16 US qt (1.1 l)	Hypoid gear oil SAE 85 W 90
	CLK 550	1.27 US qt (1.2 l)	
	CLK 63 AMG	1.27 US qt (1.2 l)	Fuchs Titan EG 5010D

Fuels, coolants, lubricants, etc.

	Model	Capacity	Fuels, coolants, lubricants, etc.
Power steering	CLK 350	approx. 1.1 US qt (1.0 l)	MB Power Steering Fluid (Pentosin CHF 11S)
	CLK 550	approx. 1.1 US qt (1.0 l)	
	CLK 63 AMG	approx. 1.3 US qt (1.2 l)	
Front wheel hubs	CLK 350	approx. 3.0 oz (85 g) each	High temperature roller bearing grease
	CLK 550	approx. 3.0 oz (85 g) each	
	CLK 63 AMG	approx. 2.5 oz (70 g) each	
Brake system		0.64 US qt (0.6 l)	MB Brake Fluid (DOT 4+)
Cooling system	CLK 350	approx. 7.8 US qt (7.4 l)	MB 325.0 Anticorrosion/Antifreeze Agent
	CLK 550	approx. 9.7 US qt (9.2 l)	
	CLK 63 AMG	approx. 11.5 US qt (10.9 l)	
Fuel tank including a reserve of		16.35 US gal (62.0 l)	Premium unleaded gasoline: Minimum Posted Octane 91 (Avg. of 96 RON / 86 MON)
	CLK 350	2.11 US gal (8.0 l)	
	CLK 550	2.11 US gal (8.0 l)	
	CLK 63 AMG	3.17 US gal (12.0 l)	
Air conditioning system			R-134a refrigerant and special PAG lu- bricant oil (never R-12)
Windshield washer system		3.2 US qt (3.0 l)	MB Windshield Washer Concentrate ¹
Heated windshield washer system and headlamp cleaning system*		6.4 US qt (6.0 l)	

¹ Use MB Windshield Washer Concentrate “MB SummerFit” and water for temperatures above freezing point or MB Windshield Washer Concentrate “MB SummerFit” and commercially available premixed windshield washer solvent / antifreeze for temperatures below freezing point. Follow suggested mixing ratios (▷ page 496).

Engine oils

Engine oils are specifically tested for their suitability in our engines and durability for our service intervals. Therefore, only use approved engine oils and oil filters required for vehicles with Maintenance System.

For a listing of approved engine oils and oil filters, refer to the Factory Approved Service Products pamphlet (USA only), or contact an authorized Mercedes-Benz Center.

! *Using engine oils and oil filters of specification other than those expressly required for the Maintenance System, or changing of oil and oil filter at change intervals longer than those called for by the Maintenance System will result in engine or emission control system damage not covered by the Mercedes-Benz Limited Warranty.*

Please follow Maintenance System recommendations for scheduled oil changes. Failure to do so will result in engine or emission control system damage not covered by the Mercedes-Benz Limited Warranty.

Engine oil additives

! *Do not blend oil additives with engine oil. They may damage the engine. Damage or malfunctions resulting from blending oil additives are not covered by the Mercedes-Benz Limited Warranty.*

Air conditioning refrigerant

R-134a (HFC) refrigerant and special PAG lubricating oil are used in the air conditioning system.

! *Never use R-12 (CFC) or mineral-based lubricating oil. Otherwise damage to the system will occur.*

Brake fluid

Warning!



During vehicle operation, the boiling point of the brake fluid is continuously reduced through the absorption of moisture from the atmosphere.

Under extremely strenuous operating conditions, this moisture content can lead to the formation of bubbles in the system, thus reducing the system's efficiency.

Therefore, the brake fluid must be replaced regularly. Refer to your vehicle's Maintenance Booklet for replacement interval.

Only brake fluid approved by Mercedes-Benz is recommended. Any authorized Mercedes-Benz Center will provide you with additional information.

Fuels, coolants, lubricants, etc.

Premium unleaded gasoline

Warning!



Gasoline is highly flammable and poisonous. It burns violently and can cause serious personal injury.

Never allow sparks, flame or smoking materials near gasoline!

Turn off the engine before refueling

Whenever you are around gasoline, avoid inhaling fumes and skin or clothing contact, extinguish all smoking materials.

Direct skin contact with fuels and the inhalation of fuel vapors can damage your health.

! *To maintain the engine's durability and performance, premium unleaded gasoline must be used. If premium unleaded gasoline is not available and low octane fuel is used, follow these precautions:*

- *Have the fuel tank only partially filled with unleaded regular gasoline and fill up with premium unleaded gasoline as soon as possible.*
- *Avoid full throttle driving and abrupt acceleration.*
- *Do not exceed an engine speed of 3000 rpm if the vehicle is loaded with a light load such as two persons and no luggage.*
- *Do not exceed $\frac{2}{3}$ of maximum accelerator pedal position if the vehicle is fully loaded or operating in mountainous terrain.*

Fuel requirements

Only use premium unleaded fuel:

- The octane number (posted at the pump) must be 91 min. It is an average of both the Research Octane Number (RON) and the Motor Octane Number (MON): $(RON+MON)/2$. This is also known as the ANTI-KNOCK INDEX.

Unleaded gasoline containing oxygenates such as ethanol, IPA, IBA and TBA can be used provided the ratio of any one of these oxygenates to gasoline does not exceed 10%; MTBE not to exceed 15%.

The ratio of methanol to gasoline must not exceed 3% plus additional co-solvents.

Using mixtures of ethanol and methanol is not allowed. Gasohol, which contains 10% ethanol and 90% unleaded gasoline, can be used.

These blends must also meet all other fuel requirements, such as resistance to spark knock, boiling range, vapor pressure, etc.

Gasoline additives

A major concern among engine manufacturers is carbon build-up caused by gasoline. Mercedes-Benz recommends only the use of quality gasoline containing additives that prevent the build-up of carbon deposits.

After an extended period of using fuels without such additives, carbon deposits can build up especially on the intake valves and in the combustion area, leading to engine performance problems such as:

- Warm-up hesitation
- Unstable idle
- Knocking/pinging
- Misfire
- Power loss

In areas where carbon deposits may be encountered due to lack of availability of gasolines which contain these additives, Mercedes-Benz recommends the use of additives approved by us for use on Mercedes-Benz vehicles.

Refer to Factory Approved Service Products pamphlet (USA only), or contact an authorized Mercedes-Benz Center for a listing of approved product(s). Follow directions on product label.

! *Do not blend other fuel additives with fuel. This only results in unnecessary cost and may be harmful to the engine operation.*

Damage or malfunction resulting from poor fuel quality or from blending additional fuel additives other than those tested and approved by us for use on Mercedes-Benz vehicles are not covered by the Mercedes-Benz Limited Warranty.

Fuels, coolants, lubricants, etc.

Coolants

The engine coolant is a mixture of water and anticorrosion / antifreeze, which provides:

- Corrosion protection
- Freeze protection
- Boiling protection (by increasing the boiling point)

The cooling system was filled at the factory with a coolant providing freeze protection to approximately -35°F (-37°C) and corrosion protection.

! *Add premixed coolant solution only. Adding water and MB 325.0 Anticorrosion/Antifreeze separately from each other, could cause engine damage not covered by the Mercedes-Benz Limited Warranty*

If the antifreeze mixture is effective to -35°F (-37°C), the boiling point of the coolant in the pressurized cooling system is reached at approximately 266°F (130°C).

The coolant solution must be used year round to provide the necessary corrosion protection and increase boil-over protection. Refer to Maintenance Booklet for replacement interval.

Coolant system design and coolant used determine the replacement interval. The replacement interval published in the Maintenance Booklet is only applicable if MB 325.0 Anticorrosion/Antifreeze solution or other Mercedes-Benz approved products of equal specification are used to renew the coolant concentration or bring it back up to the proper level.

For information on other Mercedes-Benz approved products of equal specification, refer to the Factory Approved Service Products pamphlet (USA only) or contact an authorized Mercedes-Benz Center.

To provide important corrosion protection, the solution must be at least 50% anticorrosion/antifreeze (equivalent to freeze protection to approximately -35°F [-37°C]). If you use a solution that is more than 55% anticorrosion/antifreeze (freeze protection to approximately -49°F [-45°C]), the engine temperature will increase due to the lower heat transfer capability of the solution. Therefore, do not use more than this amount of anticorrosion/antifreeze.

If the coolant level is low, water and MB 325.0 Anticorrosion/Antifreeze should be used to bring it up to the proper level (have cooling system checked for signs of leakage). Please make sure the mixture is in accordance with label instructions.

The water in the cooling system must meet minimum requirements, which are usually satisfied by normal drinking water. If you are not sure about the water quality, consult an authorized Mercedes-Benz Center.

Fuels, coolants, lubricants, etc.

Anticorrosion/antifreeze

Your vehicle contains a number of aluminum parts. The use of aluminum components in motor vehicle engines necessitates that anticorrosion/antifreeze coolant used in such engines be specifically formulated to protect the aluminum

parts. Failure to use such anticorrosion/antifreeze coolant will result in a significantly shortened service life.

Therefore, the following product is strongly recommended for use in your vehicle: MB 325.0 Anticorrosion/Antifreeze agent.

Before the start of the winter season (or once a year in hot southern regions), you should have the anticorrosion/antifreeze concentration checked. The coolant is also regularly checked each time you bring your vehicle to an authorized Mercedes-Benz Center for service.

Anticorrosion/antifreeze quantity

Model	Approximate freeze protection	
	-35°F (-37°C)	-49°F (-45°C)
CLK 350	3.9 US qt (3.7 l)	4.3 US qt (4.1 l)
CLK 550	4.9 US qt (4.6 l)	5.3 US qt (5.1 l)
CLK 63 AMG	5.8 US qt (5.5 l)	6.3 US qt (6.0 l)

Fuels, coolants, lubricants, etc.

Windshield washer system and headlamp cleaning system*

Both the windshield washer system and headlamp cleaning system are supplied from the windshield washer reservoir.

The windshield washer reservoir has a capacity of approximately:

- 3.2 US qt (3.0 l) in vehicles with windshield washer system
- 6.4 US qt (6.0 l) in vehicles with heated windshield washer system* and headlamp cleaning system*.

- ▶ Refill the reservoir with MB Windshield Washer Concentrate “MB SummerFit” and water (or concentrate and commercially available premixed windshield washer solvent / antifreeze, depending on ambient temperatures).

Warning!



Washer solvent/antifreeze is highly flammable. Do not spill washer solvent/antifreeze on hot engine parts, because it may ignite and burn. You could be seriously burned.

Windshield and headlamp washer fluid mixing ratio

For temperatures above freezing point, use MB Windshield Washer Concentrate “MB SummerFit” and water:

- 1 part “MB SummerFit” to 100 parts water
(1.34 fl oz [40 ml] “MB SummerFit” to 1 gal [4.0 l] water)

For temperatures below freezing point, use MB Windshield Washer Concentrate “MB SummerFit” and commercially available premixed windshield washer solvent / antifreeze:

- 1 part “MB SummerFit” to 100 parts solvent
(1.34 fl oz [40 ml] “MB SummerFit” to 1 gal [4.0 l] solvent)

- A**
- ABS 29, 90
 - Malfunction indicator lamp 378
 - Messages in display 394
 - Accelerator position,
 - automatic transmission 176
 - Accessory weight 358
 - Accident 58
 - Active head restraints 81
 - Resetting 440
 - Air bags 65
 - Children 83
 - Front passenger front
 - air bag off indicator lamp 76
 - Front side impact air bags 70
 - Front, Driver 70
 - Front, Passenger 70
 - Head-thorax 71
 - Occupant Classification System (OCS) 72
 - Rear side impact air bags* 70
 - Rear side-impact* 72
 - Safety guidelines 68
 - Window curtain 70
 - Air conditioning refrigerant 491
 - Air conditioning system
 - see Climate control system
 - Air conditioning, Cooling 198, 210
 - Air distribution 194, 205
 - Air pressure see Tires, Inflation pressure
 - Air recirculation mode 196, 207
 - Air vents 199, 212
 - Air volume 194, 206
 - Alarm system see Anti-theft systems
 - Alignment bolt
 - (vehicle tool kit) 422, 460, 461
 - AMG menu (CLK 63 AMG only) 148
 - Lap analysis 151
 - Overall analysis 150
 - RACETIMER 149
 - Vehicle supply voltage 148
 - Anticorrosion/antifreeze 494, 495
 - Antiglare, Rear view mirror 185, 186
 - Antilock Brake System see ABS
 - Anti-theft systems 97
 - Anti-theft alarm system 97
 - Immobilizer 97
 - Aquaplaning see Hydroplaning
 - Armrest 287
 - Ashtrays 289
 - Aspect ratio 358
 - ATF 327
 - AUDIO menu 151
 - CD player (CD, MP3-CD) 152
 - Radio station 151
 - Radio station (satellite*) 152
 - Search function 165
 - Audio system 213
 - Button and soft key operation 216
 - CD changer* 232
 - CD operation 229
 - Emergency calls "911" 248
 - MP3 230
 - Operating and display elements 214
 - Operating audio system 213
 - Operating safety 213
 - Radio operation 221
 - Sound system* 213, 217
 - Switching on/off 216
 - Telephone* operation 213, 236
 - Auto-dimming, Rear view mirror 186
 - Automatic central locking,
 - Control system 118, 166
 - Automatic climate control
 - see Climate control system
 - Automatic headlamp mode see Headlamps

- Automatic lighting control,
 - Interior lighting 136
- Automatic locking when driving 118
- Automatic shift program 178
- Automatic transmission
 - Accelerator position 176
 - Automatic shift program 178
 - Emergency operation
 - (limp-home mode) 184
 - Gear ranges 177
 - Gear selector lever 51, 172
 - Gear selector lever control
 - one-touch gearshifting 179
 - Gear selector lever positions 174
 - Gear shifting malfunctions 184
 - Kickdown 176
 - Kickdown, manual shift program 184
 - Manual shift program
 - CLK 63 AMG 182
 - Program mode selector switch 178
 - Shifting procedure 173
 - Starting engine 51
 - Steering wheel gearshift control
 - one-touch gearshifting* 180
 - Transmission fluid level 327
- Automatic Transmission Fluid see ATF

B

- Backrest 281
 - Seat, Multicontour* 124
 - Seat, Power 42
- Backup lamps
 - Messages in display 414
 - Replacing bulbs 443, 444
- Bar 358
- BAS 92
- Batteries, SmartKey
 - Changing 442
 - Checking battery condition 108
- Battery, Vehicle 329, 464
 - Charging 466
 - Connecting 466
 - Disconnecting 465
 - Installing 466
 - Jump starting 467
 - Messages in display 403
 - Removing 465
- Bead 358
- Beverage holder see Cup holder
- Block heater (Canada only) 363
- Bolts, Spare wheel 426
- Brake fluid 491
 - Checking 322
 - Message in display 404
- Brake lamp
 - Cleaning lenses 372
 - High mounted 444
 - Replacing bulbs 444, 448
- Brake pads
 - Message in display 404
- Brakes 310
 - High-performance brake system
 - (CLK 63 AMG only) 311
 - Warning lamp 380
- Break-in period 308
- Bulbs, replacing see Replacing bulbs

- C**
- California retail buyers and lessees, Important notice for 11
 - Call priority (Tele Aid) 300
 - Can holder see Cup holder
 - Capacities and recommended fuels/lubricants 489
 - Cargo area see Trunk
 - Cargo tie-down rings 284
 - Carpets, cleaning 375
 - Catalytic converter 318
 - CD changer* 229
 - MP3 230
 - CD player 229
 - Control system 152
 - Center console 31
 - Lower part 32
 - Upper part 31
 - Central locking
 - Automatic 118, 166
 - Locking/unlocking from inside 119
 - Central locking switch 119
 - Certification label 478
 - Certification label, examples 478
 - Charcoal filter 209
 - Checking tire pressure electronically
 - Tire Pressure Monitoring System (TPMS), (USA only) 344
 - Children in the vehicle 83
 - Air bags 83
 - Blocking
 - rear side window operation 88
 - Front passenger front
 - air bag off indicator lamp 76
 - Infant and child restraint systems 77, 83, 86
 - LATCH-type child seat anchors 87
 - Occupant Classification System (OCS) 72
 - Cigarette lighter 290
 - Climate control
 - see Climate control system
 - Climate control system
 - Air conditioning refrigerant 491
 - Air conditioning, Cooling 198, 210
 - Air distribution 194, 205
 - Air recirculation mode 196, 207
 - Air vents 199, 212
 - Air volume 194, 195, 206
 - Charcoal filter 209
 - Control panel,
 - Automatic climate control 201
 - Deactivating/Reactivating 193, 203
 - Defogging 206
 - Defrosting 206
 - Defrosting, rear window 189
 - Front defroster 195
 - MAXCOOL 207
 - Residual engine heat and ventilation* (REST*) 211
 - Temperature 194, 204
- Clock 29, 140, 160
 - Setting time 160
 - Cockpit 26
 - Cold tire inflation pressure 358
 - Collapsible wheel chock 422, 424
 - COMAND* see separate
 - COMAND operating instructions
 - Combination switch 55, 133
 - Control system 141
 - Functions 143, 145
 - Multifunction display 141
 - Multifunction steering wheel 142
 - Resetting to factory default 155

- Control system menus 144, 145
 - AMG 148
 - AUDIO 151
 - NAV* 153
 - Settings 155
 - Settings, Submenus 156
 - Standard display 147
 - Submenus 143
 - TEL* 169
 - Trip computer 167
 - Vehicle status message memory 154
- Control system submenus 143, 145, 157
 - Convenience 166
 - Instrument cluster 158
 - Lighting 162
 - Time/Date 160
 - Vehicle 165
- Coolant 328, 494
 - Adding 328
 - Anticorrosion/antifreeze
 - mixing ratio and quantity 494
 - Capacities 489
 - Checking coolant level 328
 - Messages in display 405–407
 - Temperature 319
 - Temperature indicator 139
 - Warning lamp 382
- Coolants 494
- Corner-illuminating front fog lamps* 133
 - Replacing bulbs 444
- Cruise control 267
 - Canceling 269
 - Cruise control lever 267
 - Current speed 268
 - Fine adjustment 270
 - Higher speed 269
 - Last stored speed ("Resume"
 - function) 270
 - Slower speed 270
- Cup holder 288
- Curb weight 358
- D**
 - Date 160
 - Date, Setting 161, 162
 - Daytime running lamp mode 131
 - Setting 162
 - Deep water see Standing water
 - Defogging
 - Windshield 196, 206
 - Defrosting, Front 195, 206
 - Defrosting, Rear 189
 - Delayed shut-off
 - Exterior lamps 164
 - Interior lighting 165
 - Department of Transportation see DOT
 - Difficulties
 - With starting 53
 - Digital speedometer 147
 - Dimensions, Vehicle 488
 - Direction of rotation (tires) 334
 - Displays
 - Digital speedometer 147
 - Lap analysis 151
 - Maintenance service indicator 364
 - Messages in display 392
 - Multifunction display 141
 - Outside temperature 140

Overall analysis 150
 RACETIMER 149
 Symbol messages 403-420
 Text messages 394-401
 Vehicle status message memory 154
 Vehicle status messages
 see Multifunction display messages
 Vehicle supply voltage 148
 Distance to empty (Range),
 Trip computer 168
 Door
 Entry lamps 137
 Handle (inside) 34
 Locking/unlocking,
 KEYLESS-GO* 37, 106
 Locking/unlocking,
 SmartKey 36, 102
 Opening from inside/outside 109
 Remote door unlock (Tele Aid) 300
 Unlocking, Mechanical key 427
 Door control panel 34
 Door handle 109
 DOT 358
 Drinking and driving 309

Driving
 Abroad 317
 Hydroplaning 314
 In winter 316
 Instructions 48, 309
 Problems 58
 Safety systems 90
 Systems 267
 Through standing water 317
 Driving off 312
 Driving safety systems
 ABS 90
 BAS 92
 Electronic traction system 94
 ESP® 92
 Driving systems
 Cruise control 267
 Parktronic system*
 (CLK 63 AMG (USA),
 Canada all models) 271
 Driving tips 176
 Accelerator position 176
 Kickdown 176

E

Easy-entry/exit feature 45, 166
 Electrical fuses see Fuses
 Electrical outlet 291
 Electrical system, Technical data 487
 Electronic Stability Program see ESP®
 Emergency call system* 295
 Emergency calls
 911 calls 248
 Tele Aid calls 296, 297
 Emergency, In case of
 Instrument cluster,
 Indicator lamps 378-388
 Emergency operation
 (Limp-Home Mode) 184
 Emergency operations
 Active head restraints, Resetting 440
 Center console,
 Indicator lamps 390-391
 Gear selector lever, Unlocking 429
 Instrument cluster,
 Indicator lamps 378-387
 Remote door unlock 300

- Roll bars, Lowering 431
- Roll bars, Releasing 430
- Soft top, Closing 432–439
- Trunk lid, Releasing from inside 117
- Trunk lid, Unlocking 428
- Unlocking/locking
 - the vehicle 427, 428
- Emergency tensioning device see ETD
- Emergency, In case of
 - Battery, Jump starting 467
 - First aid kit 421
 - Flat tire, Changing 452
 - Fuses 472
 - Hazard warning flasher 135
 - Roadside Assistance 12, 298
 - Towing the vehicle 469
- Emission control 318
- Emission control information label 479
- Emission system warranties 10
- Engine
 - Belt layout 480
 - Block heater (Canada only) 363
 - Break-in recommendations 308
 - Cleaning 369
 - Compartment 323
 - Malfunction indicator lamp 29, 381
 - Maximum engine speed 481
 - Message in display 405
 - Number 479
 - Starting 51
 - Starting difficulties 53
 - Starting with KEYLESS-GO* 52
 - Starting with SmartKey 52
 - Technical data 481
 - Turning off 60
 - Turning off with KEYLESS-GO* 60
 - Turning off with SmartKey 60
- Engine coolant see Coolant
- Engine oil 325, 491
 - Adding 327, 491
 - Additives 491
 - Changing 327, 491
 - Checking level 322, 325
 - Consumption 325
 - Filler cap 327
 - Filler neck 327
- Engine oil level 322
- ESP® 92
 - Messages in display 394–395
 - Warning lamp 384
- ETD 80
 - Safety guidelines 68
- Exterior rear view mirrors 47, 186
- Exterior view 22, 24

F

- Filler cap, Engine oil 327
- Filler neck, Engine oil 327
- First aid kit 421
- Flat tire 452
 - Jacking up the vehicle 459
 - Lowering the vehicle 462
 - Minispare wheel 425
 - Mounting the spare wheel 458
 - Preparing the vehicle 452
 - TIREFIT (CLK 63 AMG only) 422
 - TIREFIT kit* 452
- Floormats* 291
- Fluids
 - Brake fluid 322, 491
 - Engine coolant 322, 494
 - Engine oil 322, 491
 - Windshield washer and headlamp cleaning* system 322, 496
- Fog lamps 132, 444
 - Messages in display 412
 - Replacing bulbs 444, 445, 448
- Front air bags 70
- Front lamps see Headlamps
- Front passenger front air bag 65, 70
 - Messages in display 396–399
- Front passenger front air bag
 - off indicator lamp 31, 76, 390
- Front seat head restraints
 - see Head restraints
- Fuel 321, 489
 - Additives 493
 - Automatic transmission fluid 489
 - Brake fluid 490
 - Capacities 489
 - Capacities, Fuel tank 490
 - Engine coolant 490
 - Engine oil 489
 - Filling the tank 320
 - Fuel display 29
 - Fuel filler flap and cap 320
 - Fuel filler flap and cap, Multifunction display messages 408
 - Fuel reserve warning lamp 385
 - Power steering fluid 490
 - Premium
 - unleaded gasoline 321, 490, 492
 - Requirements, Octane rating 492
 - Technical data 489
- Fuel cap
 - Message in display 382
- Fuel consumption statistics
 - After start 167
 - Resetting 168
 - Since last reset 168
- Fuel filler flap 320
 - Locking/unlocking 320
 - Opening 320
- Fuel reserve warning lamp 29
- Fuel tank
 - Capacity 490
 - Filler flap 320
- Fuel, Premium
 - unleaded gasoline 321, 492
- Fuels, coolants, lubricants etc.
 - Capacities 489
- Fuses 472
 - Fuse box (main)
 - in passenger compartment 472
 - Fuse box
 - in engine compartment 473
 - Fuse box
 - in trunk 474
 - Replacing 472

G

- Garage door opener 33, 301
- Gasoline see Fuel
- GAWR 358
- Gear range
 - Automatic transmission 177
 - Limiting 177
 - Shifting into optimal 180, 182
- Gear selector lever 51, 172
 - Cleaning 375
 - Gearshift pattern 172
 - Lock 52
 - Message in display 400
 - Position 173, 174
 - Position indicator 29, 141
 - Shifting procedure 173
 - Unlocking in an emergency 429
- Gear selector lever one-touch gearshifting
 - Automatic transmission 179
- Global locking/unlocking
 - see Key, SmartKey or KEYLESS-GO*
- Glove box 285
- Gloves 422
- Good visibility 185
- Gross Axle Weight Rating see GAWR
- Gross Vehicle Weight Rating see GVWR

Gross Vehicle Weight see GVW

GVW 358

GVWR 359

H

- Halogen headlamp see Headlamps
- Hands-free microphone 33
- Hard plastic trim items, cleaning 375
- Hazard warning flasher 135
- Head restraints 43, 120
 - Active head restraints 81
 - Front seat 120
 - Power seat, Adjusting 43
 - Rear seat 120, 123
 - Rear seat, Folding back 121
 - Rear seat, Lowering 123
 - Rear seat, Placing upright 122
 - Rear seat, Raising 123
 - Rear seat, Removing/installing 122
- Headlamp
 - cleaning system* 185, 330, 496
- Headlamp delayed shut-off see
 - Delayed shut-off, Exterior lamps

Headlamps

- Automatic headlamp mode 130
- Cleaning lenses 372
- Daytime running lamp mode 131
- Halogen 446
- High beam see High beam flasher
- High beam see High beam headlamps
- Light sensor 411
- Locator lighting 132
- Low beam headlamps 130
- Low beam see Low beam headlamps
- Manual headlamp mode 130
- Messages in display 411–415
- Night security illumination 132
- Replacing bulbs 444, 446
 - Switch 55, 129
- Headliner and shelf below rear window,
 - Cleaning and care of 375
- Head-thorax air bag 71
- Heated seats* 125
- High beam flasher 55, 133
 - Replacing bulbs (Bi-Xenon*) 444
 - Replacing bulbs (Halogen) 444

High beam headlamps 133
Indicator lamp 29
Messages in display 412
Replacing bulbs (Bi-Xenon*) 444
Replacing bulbs (Halogen) 444, 446
Replacing bulbs for
high beam flasher (Bi-Xenon*) 447
Switching on 55
High mounted brake lamp 444
Hood 323
Horn 27
HVAC see Climate control system
Hydroplaning 314

I

Identification labels 478
Identification number,
Vehicle (VIN) 478, 479
Ignition
with KEYLESS-GO* 40
with SmartKey 38
Immobilizer 97
Indicator lamps see
Lamps, indicator and warning
Infant and child restraint systems see
Children in the vehicle
Inflation pressure see
Tires, Inflation pressure
Inside door handle 34, 109
Instrument cluster 28, 138
Illumination brightness 138
Lamps in 378–387
Messages in display see
Multifunction display messages
Multifunction display 141
Instrument lighting see Instrument
cluster, Illumination brightness
Instrument panel see Instrument cluster
Instruments and controls see Cockpit

Interior lighting 136
Delayed shut-off 165
Interior rear view mirror 47, 186
Antiglare position 185
Auto-dimming 186
Interior storage spaces see
Storage compartments

J

Jack 422
Jacking up the vehicle 459
Jump starting 467

K

- Key, Mechanical 427
- Key, SmartKey 100
 - Batteries 108
 - Battery check lamp 102, 107
 - Changing batteries 442
 - Factory setting 102, 103
 - Ignition 38
 - Locking/unlocking 36, 62, 100
 - Locking/unlocking,
 - Global setting 102
 - Locking/unlocking,
 - Selective setting 102
 - Loss of 109
 - Message in display 411
 - Opening and closing the
 - power tilt/sliding sunroof* 257
 - Opening and closing the
 - power windows 253
 - Opening and closing the soft top 263
 - Positions in starter switch 38
 - Remote control 100
 - SmartKey with KEYLESS-GO* 103
 - Starting the engine 52
 - Steering wheel lock 38
 - Turning off the engine 60

- Unlocking/opening trunk lid 103

KEYLESS-GO* 103

- Battery check lamp, SmartKey 107
- Factory setting 106, 108
- Ignition 40
- Important notes 105
- Lock button 62
- Locking/unlocking 37, 62, 103
- Locking/unlocking,
 - Global setting 106
- Locking/unlocking, Selective
 - setting 107
- Loss of key 109
- Messages in display 410
- Remote control 103
- Start / stop button 39
- Starting the engine 52
- Turning off the engine 60
- Unlocking/opening trunk lid 108
- Kickdown 176
- Kilopascal 359

L

- Labels 478
 - Certification 478
 - Emission control information 479
- Lamp sensor see Light sensor
- Lamps, exterior 444
 - Light sensor 411
 - Messages in display 411–415
- Lamps, indicator and warning
 - ABS 29, 378
 - Battery (SmartKey) 102, 107
 - Brakes 29, 380
 - Center console 390–391
 - CHECK ENGINE 381
 - Coolant 382
 - Coolant temperature 29, 139
 - Distance warning 29
 - Engine diagnostics 381
 - Engine malfunction 29, 381
 - ESP® 384
 - Fog lamps 132
 - Front passenger front air bag off 70
 - Front passenger front
 - air bag off indicator lamp 390
 - Fuel reserve 29, 385
 - High beam headlamp 29

Instrument cluster 378–387, 388
 Low beam headlamp 29
 Parktronic system* warning
 indicators (Canada only) 273
 Roll bar 385
 Seat belt telltale 29
 SRS 29, 65, 387
 Turn signals 29
 Language, Setting 158
 LATCH-type child seat anchors see
 Children in the vehicle
 License plate lamps
 Messages in display 413
 Replacing bulbs 444, 449
 Light alloy wheels, cleaning 374
 Light sensor
 Messages in display 411
 Lighter see Cigarette lighter
 Lighting, Exterior and interior 129
 Limp-home mode 184
 Load limit 360
 Loading
 Ski bag* (Canada only) 278
 Loading see Vehicle loading
 Loading the vehicle 334
 Locator lighting 132, 163

Lock buttons
 Door handle (KEYLESS-GO*) 62, 107
 Loss of keys 109
 Loss of Service and
 Warranty Information Booklet 477
 Low beam headlamps
 Indicator lamp 29
 Messages in display 413
 Replacing bulbs (Bi-Xenon*) 444
 Replacing bulbs (Halogen) 444, 446
 Switching on 55
 Lubricants 489
 Luggage cover 264
 Folding back 276

M

Maintenance 12, 364
 Calling up service indicator 366
 Clearing service indicator 365
 Maintenance System
 (U.S. vehicles) 364
 Resetting service indicator 366
 Service indicator 364
 Service term exceeded 365
 Manual headlamp mode see Headlamps
 Manual shift program
 Deactivating 184
 Manual shift program CLK 63 AMG 182
 MAXCOOL maximum cooling 207
 Maximum load rating, Tires 359
 Maximum loaded vehicle weight,
 Tire inflation pressure 359
 Maximum tire inflation pressure 359
 Mechanical key 427
 Memory function see Seats, Power
 Menus see Control system menus
 Microphone, Hands-free 33
 Minispare wheel see Spare wheel

- Mirrors
 - Adjusting 47
 - Antiglare position 185
 - Auto-dimming 186
 - Exterior rear view mirrors 47
 - Interior rear view mirror 47
 - Mobile phone see Telephone*
 - MOE tires* see *MOExtended* system*
 - MOE* see *MOExtended* system*
 - MOExtended* system* 463
 - MOExtended* tires* 482
 - MON 321
 - Motor Octane Number see MON
 - MP3 230
 - Multicontour seat* see Seats, Multicontour*
 - Multifunction display 141
 - Changing settings see Control system menus and Control system submenus
 - Selecting language 158
 - Symbol messages 403–420
 - Text messages 394–401
 - Multifunction display messages 392
 - ABS 394
 - Battery 403
 - Brake fluid 404
 - Brake pads 404
 - Check engine 405
 - Coolant 405–407
 - Engine 405
 - Engine coolant 405–407
 - ESP® 394
 - Fog lamps 412
 - Front passenger
 - front air bag 396–399
 - Fuel cap 408
 - Gear selector lever 400
 - Headlamps 411–415
 - Key, SmartKey 411
 - KEYLESS-GO* 410
 - Lamps 413
 - Lamps, exterior 411–415
 - License plate lamp 413
 - Light sensor 411
 - Low tire pressure 419
 - Parking brake 404
 - Parking lamps 412
 - Roll bars 417
 - Soft top 420
 - SRS 416
 - Steering gear oil 417
 - Tele Aid 418
 - Telephone* 418
 - Turn signals 412
 - Windshield washer fluid 420
 - Multifunction steering wheel 30, 142
 - Button operation 142
- N**
- Navigation system* 153
 - See separate COMAND* operating instructions
 - Net, Parcel 286
 - Neutral gear position,
 - Automatic transmission 172, 174
 - New vehicle break-in 308
 - Night security illumination 132
 - Normal occupant weight 359
 - Number, paintwork code 478
 - Number,
 - vehicle identification (VIN) 478, 479

O

Occupant Classification System see OCS
 Occupant distribution 359
 Occupant safety 64

- Active head restraints 81
- Air bags 65
- Children and air bags 83
- Children in the vehicle 83
- ETD 80
- Fastening the seat belts 48
- Front air bags 70
- Front passenger front air bag off indicator lamp 76, 390
- Front side impact air bags 70
- Head-thorax air bags 71
- Infant and child restraint systems 83
- LATCH-type child seat anchors 87
- OCS 72
- Rear side impact air bags* 70
- Rear side-impact air bags* 72
- Roll bars 82
- Seat belts 48, 77
- Seat belts, safety guidelines 68
- SRS 64
- Window curtain air bags 70

OCS 72

Self-test 76

Odometer 29

Oil level see Engine oil, checking level

One-touch gearshifting

Gear selector lever 179

Steering wheel

gearshift control* 180

Operating safety 213

Operating the vehicle outside the

USA or Canada 13

Ornamental moldings, Cleaning 372

Outside temperature see Displays

Overdue maintenance service 365

Overhead control panel 33

P

Paintwork code 478

Paintwork, Cleaning 368

Panic alarm 89

Parcel net

Front passenger footwell 286

Parking 59, 312

Over combustible materials 59, 312

Parking assist* see Parktronic system*
 (CLK 63 AMG (USA), Canada all vehicles)

Parking brake 53, 59

Message in display 404

Warning sounds 54

Parking lamps 129

Messages in display 412

Replacing bulbs 444, 447, 448

Parktronic system* (Canada only)

Malfunction 274

Range of the sensors 272

Switching on/off 274

Warning indicators 273

Warning sounds 273, 274

Parktronic system* (CLK 63 AMG (USA),
 Canada all models) 271

Cleaning system sensors 372

Parts service 476

- PASS AIR BAG OFF indicator lamp see
 - Front passenger front air bag off indicator lamp
 - Passenger compartment 317
 - Electrical outlet 291
 - Interior lighting 136
 - Interior rear view mirror 47
 - Main fuse box 472
 - Parcel net in
 - front passenger footwell 286
 - Storage bags, rear side
 - of the front seats 286
 - Passenger safety see Occupant safety
 - Pedals 309
 - Phone see Telephone
 - Plastic parts, cleaning 374
 - Poly-V-belt drive
 - Layout 480
 - Positions (Memory function)
 - see Seats, Power
 - Power assistance 310
 - Power seat see Seats, Power
 - Power tilt/sliding sunroof* 256
 - Express opening/closing 257
 - Opening/closing 256
 - Stopping 258
 - Synchronizing 258
 - Power washer 368
 - Power windows 250
 - Cleaning 373
 - Convenience closing feature 254
 - Express opening/closing 251
 - Opening with soft top switch 255
 - Operating 250
 - Rear side windows,
 - Blocking operation 88
 - Summer opening feature 253
 - Synchronizing 252
 - Practical hints 378
 - Premium unleaded gasoline 492
 - Problems
 - While driving 58
 - With vehicle 17
 - Product information 9
 - Production options weight 359
 - Program mode see Automatic transmission, Automatic shift program
 - Program mode selector switch
 - Automatic shift program 178
 - PSI 359
 - Push-start see Tow-start
- R**
- RACETIMER (CLK 63 AMG only) 149
 - Radio
 - Operation 221
 - Search function 165
 - Selecting stations 151
 - Selecting stations (satellite*) 152
 - Radio transmitters 317
 - Range (distance to empty) 168
 - Reading lamp 33, 137
 - Rear bench seat, foldable 281
 - Rear fog lamp see Fog lamps
 - Rear lamps see Tail lamps
 - Rear seat ashtray see Ashtray
 - Rear seat head restraints see Head restraints
 - Rear side windows
 - Blocking operation 88
 - Rear side-impact air bags* 72
 - Rear view mirrors see Mirrors
 - Rear window defroster 189
 - Rear window sunshade* (Canada only) 188
 - Recommended engine oils and oil filter 491

- Recommended
 - tire inflation pressure 359
- Recovery services,
 - Stolen vehicle (Tele Aid) 301
- Refrigerant, Air conditioning 491
- Refueling 320
- Regular checks 322
- Remote control
 - SmartKey 100, 103
 - SmartKey with KEYLESS-GO* 103
- Remote door unlock (Tele Aid) 300
- Removing
 - Ski bag* (Canada only) 280
- Replacing bulbs 443
 - Additional turn signals 444
 - Backup lamps 444, 448
 - Brake lamps 444
 - Corner-illuminating
 - front fog lamp* 444
 - Fog lamps 444, 448
 - Headlamp bulbs 446
 - Headlamps 444
 - High beam flasher (Bi-Xenon*) 444
 - High beam flasher (Halogen) 444
 - High beam headlamps
 - (Bi-Xenon*) 444
 - High beam headlamps
 - (Halogen) 444, 446
 - High mounted brake lamp 444
 - License plate lamps 444, 449
 - Low beam headlamps
 - (Bi-Xenon*) 444
 - Low beam headlamps
 - (Halogen) 444, 446
 - Parking lamps 444, 447, 448
 - Side marker lamps 444
 - Standing lamps 444, 447, 448
 - Tail lamps 444, 448
 - Turn signal lamps 444, 448
 - Turn signal lamps (Bi-Xenon*) 448
 - Turn signal lamps (Halogen) 447
- Reporting safety defects 18
- Research Octane Number see RON
- Reset button,
 - In instrument cluster 29, 138, 156
- Residual heat and ventilation* see REST*
- REST* 211
- Restraint system see
 - Children in the vehicle
- Restraint system see SRS
- Reverse gear position,
 - Automatic transmission 172, 174
- Rims 359, 482
- Roadside Assistance 12, 298
- Roll bar 82
 - Messages in display 417
 - Operating manually 430
 - Warning lamp 385
- RON 321
- Roof rack 275
- Rubber parts, cleaning 374
- Run Flat Indicator (Canada only) 342

S

- Safety
 - Driving safety systems 90
 - Occupant 64
 - Reporting defects 18
- Safety belts see Seat belts
- Satellite radio* 225
- Seat belts 77
 - Automatic comfort-fit feature 80
 - Children in the vehicle 83
 - Cleaning 375
 - ETD 80
 - Fastening 48
 - Force limiter 80
 - Proper use of 50, 78
 - Safety guidelines 68
 - Telltale 29
- Seating capacity 335
- Seats, Multicontour* 124
 - Backrest contour 124
 - Backrest side bolsters 124
 - Cushion depth 124
- Seats, Power 41, 120
 - Active head restraints 81
 - Adjustment 42
 - Easy entry/exit feature 45
 - Heating* 125
 - Memory function 127
 - Ventilation* 126
- Seats, Rear bench seat 281
- Securing cargo 283
- Selector lever see Gear selector lever
- Self-test
 - OCS 76
 - Tele Aid 295
- Service and Warranty Booklet
 - Loss of 477
- Service and warranty information 10
- Service life, Tires 332
- Service see Maintenance
- Service System see Maintenance
 - Maintenance System
- Service, Parts 476
- Settings
 - Control system menus 144
 - Control system submenus 143, 145
 - Date 161, 162
 - Factory, KEYLESS-GO* 106
 - Factory, SmartKey 102
 - Global, KEYLESS-GO* 106
 - Global, SmartKey 102
 - Individual vehicle 155
 - Memory function 127
 - Menus and submenus 144
 - Resetting all, Control system 155
 - Selective, KEYLESS-GO* 107
 - Selective, SmartKey 102
 - Time 160
- Shelf below rear window, Cleaning 375
- Shift program mode,
 - Automatic transmission 178
- Shifting
 - Gear selector lever 51
- Shifting,
 - Automatic transmission 54, 172
- Side impact air bags, Front 70
- Side impact air bags, Rear* 70
- Side marker lamps
 - Cleaning lenses 372
 - Messages in display 413
 - Replacing bulbs 444
- Side windows see Power windows
- Sidewall 359

- Ski bag* (Canada only) 276
 - Loading 278
 - Luggage cover 276
 - Removing 280
 - Ski bag roller blind 276, 280
 - Unfolding (Cabriolet) 276
 - Unfolding (Coupe) 277
 - Unloading and folding 279
- Ski bag* roller blind 276
- SmartKey see Key, SmartKey
- SmartKey with KEYLESS-GO*
 - see KEYLESS-GO*
- Snow chains 363
- Snow tires 362
- Soft top 259
 - Cleaning 370
 - Emergency operations 432–439
 - Locking after raising/lowering 262
 - Luggage cover 264
 - Messages in display 420
 - Opening/closing 259
 - Opening/closing, SmartKey 263
 - Opening/closing,
 - Soft top switch 260, 261
 - Wind screen 265
- Soft top switch 255, 260
- Sound system* 213, 217
- Spare parts service see Parts service
- Spare wheel 425
 - Bolts 422, 426
 - Mounting 458
 - Sizes 486
- Speedometer 29, 158
- SRS 64, 78
 - Indicator lamp 29, 65, 387
 - Message in display 416
- Standard display, Selecting display 159
- Standing lamps 447, 448
 - Replacing bulbs 444
- Standing water, Driving through 317
- Starter switch 27, 38
 - Positions 38
- Starting difficulties, Engine 53
- Starting, Engine 51
- Status line, Selecting display 159
- Steering column 44, 45
- Steering gear oil
 - Message in display 417
- Steering wheel 44, 45
 - Buttons 30
 - Cleaning 375
 - Lock 53
- Steering wheel gearshift control
 - one-touch gearshifting*
 - Automatic transmission 180
- Stolen Vehicle Recovery services 301
- Storage box 285
- Storage compartments 285
 - Armrest, Front 287
 - Armrest, Rear 287
 - Cup holder 288
 - Glove box 285
 - Parcel net 286
 - Storage bags 286
 - Storage box 285
- Storing
 - Tires 333
- Sun visors 187
- Sunroof* see Power tilt/sliding sunroof*
- Sunshade* (Canada only) 188
- Supplemental Restraint System see SRS
- Symbols used
 - in this operator's manual 15

T

- Tachometer 29, 140
 - Overspeed range 140
- Tail lamps
 - Cleaning lenses 372
 - Messages in display 414, 415
 - Replacing bulbs 444, 448
- Tar stains 368
- Technical data
 - Air conditioning refrigerant 491
 - Brake fluid 491
 - Capacities fuels, coolants, lubricants etc. 489, 490
 - Coolant 490, 494
 - Electrical system 487
 - Engine 481
 - Engine oil 491
 - Engine oil additives 491
 - Fuel capacity 490
 - Fuel requirements 492
 - Gasoline additives 493
 - Lubricants 489
 - Premium unleaded gasoline 492
 - Rims and tires 482
 - Tires, Mixed size 484
 - Tires, Same size 483
 - Tires, Spare wheel sizes 486
 - Vehicle dimensions 488
 - Weights 488
 - Windshield washer and headlamp cleaning* system 490, 496
- Tele Aid 33, 295
 - Call priority 300
 - Emergency calls 296
 - Hands-free microphone 33
 - Information 299
 - Initiating an emergency call manually 297
 - Messages in display 418
 - Remote door unlock 300
 - Roadside Assistance 298
 - SOS button 297
 - Stolen Vehicle Recovery services 301
 - System self-check 295
 - Tele Aid System 295
- Telephone* 30, 169, 292
 - Answering/ending a call 170
 - Changing mobile phone cradle 294
 - Hands-free microphone 33
 - Inserting in cradle 293
 - Installing a different mobile phone cradle 294
 - Messages in display 418
 - Operation 169, 236
 - Phone book 170
 - Redialing 171
 - Removing from cradle 294
 - TEL* menu 169
- Temperature
 - Interior temperature 194, 204
- Tie-down rings, Trunk 284
- Tightening torque, Wheel bolts 462
- Tilt/sliding sunroof* see Power tilt/sliding sunroof*
- Time 160
- Time, Setting 160
- TIN 360
- Tire and Loading Information Placard 335
- Terminology 358
- Tire inflation pressure 455
 - Checking tire pressure electronically, Tire Pressure Monitoring System (TPMS), (USA only) 344
- Tire inflation pressure see the placard on the fuel filler flap

- TIREFIT (CLK 63 AMG only) 422
- TIREFIT*
 - Instructions for use 452
- Tires 331, 482
 - Air pressure 358
 - Care and maintenance 332
 - Chains 363
 - Cleaning 333
 - Combination low tire pressure/TPMS malfunction telltale, USA only 29
 - Direction of rotation, Spinning 334
 - Driving instructions 313
 - Important notes,
 - Tire inflation pressure 340
 - Inflation pressure 322, 339, 341
 - Inflation pressure,
 - Information placard 339
 - Inspection 332
 - Load rating 360
 - Low tire pressure telltale 388
 - MO*Extended* system* 463
 - MO*Extended** 348, 482
 - Ply composition
 - and material used 360
 - Problems under-/overinflated 347
 - Retreads 331
- Rims and tires 482
 - Rotation 361
 - Run Flat Indicator 342
 - Service life 332
 - Sizes 483
 - Snow 362
 - Spare wheel 425, 458, 486
 - Speed rating 315, 351, 360
 - Storing 333
 - Temperature 340, 357
 - Terminology 358
 - Tire Identification Number see TIN
 - Tire Pressure Monitoring System (TPMS)*, (USA only) 344
 - TIREFIT (CLK 63 AMG only) 422
 - Total load limit 360
 - TPMS malfunction telltale 388
 - Traction 314, 360
 - Tread 360
 - Tread depth 333, 362
 - Treadwear indicators 360
 - Wear pattern 361
 - Winter 362
- Tools 422
- Top tether
 - Children in the vehicle 86
 - Tether attachment points 86
- Total load limit 360
- Towing eye bolt 422, 470, 471
- Towing the vehicle 469
- Tow-start 467, 469
- TPMS (USA only) 344
- Traction 94, 314, 360
- Transmission see Automatic transmission
- Traveling abroad 317
- Tread 360
- Tread depth 333, 362
- Treadwear indicators 360
- Trip computer 167
- Trip odometer 139
- Trunk
 - Closing from inside 112
 - Fuse box 474
 - Lamp 137
 - Lid 110
 - Luggage cover 264
 - Opening 110
 - Opening, from inside 111
 - Tie-down rings 284

- Trunk lid 112
 - Trunk lid emergency release 117
 - Unlocking in an emergency 428
 - Unlocking/opening,
 - KEYLESS-GO* 108
 - Unlocking/opening, SmartKey 103
 - Valet locking 118
 - Turn signal lamps
 - Cleaning lenses 372
 - Messages in display 412
 - Replacing bulbs (Bi-Xenon*) 448
 - Replacing bulbs (Halogen) 447
 - Replacing bulbs (rear) 448
 - Turn signals 56
 - Additional in mirrors 444
 - Bulbs 444
 - Bulbs (Bi-Xenon)) 448
 - Cleaning lenses 372
 - Indicator lamps 29
 - Turning off engine 60
- U**
- Uniform Tire Quality
 - Grading Standards 360
 - Units, Settings
 - Speedometer 158
 - Unleaded gasoline, Premium 492
 - Upholstery, Cleaning 376
 - Useful features 285
- V**
- Vehicle
 - Battery 329, 464
 - Break-in period 308
 - Care 367
 - Control system, Settings menu 155
 - Dimensions 488
 - Jump starting 467
 - Locking/Unlocking,
 - KEYLESS-GO* 37, 62, 103
 - Locking/Unlocking,
 - SmartKey 36, 62, 100
 - Lowering 462
 - Modifications and alterations,
 - Operating safety 16
 - Towing 469
 - Unlocking/locking
 - in an emergency 427, 428
 - Washing 369
 - Weights 488
 - Vehicle identification number see VIN
 - Vehicle jack 422, 423, 459
 - Vehicle lighting 322
 - Vehicle loading
 - Cargo tie-down rings 284
 - Instructions 283, 334
 - Load limit 334
 - Roof rack* 275
 - Split rear bench seat 281
 - Terminology 358
 - Vehicle maximum load on the tire 360
 - Vehicle recovery services,
 - Stolen (Tele Aid) 301
 - Vehicle status message memory 154
 - Vehicle status messages 392
 - Vehicle system settings,
 - Control system 141
 - Vehicle tool kit 422
 - Vehicle washing 367
 - VIN 478

W

Warning indicators

- Parktronic system*
(Canada only) 273

Warning sounds

- Driver's or passenger's seat belt 79
- Parking brake 54
- Parktronic system*
(Canada only) 273, 274
- Seat belt telltale 386

Warranty coverage 10, 477

Washer fluid see Windshield washer fluid

Washer reservoir level 490

Washing the vehicle 367

Wear pattern, Tires 361

Weights, Vehicle 488

Wheel

- Bolts 426
- Change 458
- Collapsible wheel chock 422
- Removing 460
- Spare 458
- Tightening torque 462
- TIREFIT (CLK 63 AMG only) 422
- Wrench 422

Wheels, Sizes 483

Wheels, Tires and 331

Wind screen 265

Window curtain air bags 70

Windows see Power windows

Windshield

- Cleaning 57, 373
- Defogging 196, 206

Windshield washer fluid 330, 496

- Message in display 420
- Mixing ratio 496
- Refilling 330
- Reservoir level 490

Wiping 57

Windshield washer system 490, 496

Windshield wipers 56

- Cleaning wiper blades 373
- Replacing wiper blades 450

Winter driving 362

- Block heater (Canada only) 363
- Snow chains 363
- Tires 362

Winter driving instructions 316

Winter tires 362

Wood trims, cleaning 376

Service and Literature

Your authorized Mercedes-Benz Center has trained technicians and Genuine Mercedes-Benz Parts to service your vehicle properly.
For expert advice and quality service, contact an authorized Mercedes-Benz Center.

If you are interested in obtaining service literature for your vehicle, please contact an authorized Mercedes-Benz Center.
We consider this the best way for you to obtain accurate information for your vehicle.

For further information you can find us on the Mercedes-Benz web-site www.mbusa.com or www.mercedes-benz.ca.

Warning!



To help avoid personal injury, be extremely careful when performing any service work or repairs. Improper or incomplete service or the use of incorrect or inappropriate parts or materials may damage the vehicle or its equipment, which may in turn result in personal injury.

If you have questions about carrying out any type of service, turn to the advice of an authorized Mercedes-Benz Center.

We reserve the right to make changes in design and equipment.

Therefore, information, illustrations and descriptions in this Operator's Manual might differ from your vehicle.
Reprinting, translation and copying, even of excerpts, is not permitted without our prior authorization in writing.

Press time May 08, 2007

GSP/TID

Printed in U. S. A.

