



Mercedes-Benz

# E-Class

Operator's Manual

## Symbols

Trademarks®:

- Bluetooth® is a registered trademark of Bluetooth SIG Inc.
- ESP® and PRE-SAFE® are registered trademarks of Daimler.
- HomeLink® is a registered trademark of Prince, a Johnson Controls Company.

The following symbols are found in this Operator's Manual:

### **Warning!**

Warning notices draw your attention to hazards that may endanger your health or life, or the health or life of others.

 Highlights hazards that may result in damage to your vehicle.

 Helpful hints or further information you may find useful.

▶ This symbol points to instructions for you to follow.

▶ A number of these symbols appearing in succession indicates a multiple-step procedure.

▷ page This symbol tells you where to look for further information on a topic.

▷▷ This continuation symbol marks a warning or procedure which is continued on the next page.

Display Text in displays, such as the control system, are printed in the type shown here.

Our company and staff congratulate you on the purchase of your new Mercedes-Benz.

Your selection of our product is a demonstration of your trust in our company name. Furthermore, it exemplifies your desire to own an automobile that will be as easy as possible to operate and provide years of service.

Your Mercedes-Benz represents the efforts of many skilled engineers and craftsmen. To help assure your driving pleasure, and also the safety of you and your passengers, we ask you to make a small investment of time:

- Please read this manual carefully, then return it to your vehicle where it will be handy for your reference.
- Please follow the recommendations contained in this manual. They are designed to acquaint you with the operation of your Mercedes-Benz.
- Please pay attention to the warnings and cautions contained in this manual. They are designed to help improve the safety of the vehicle operator and occupants.

We extend our best wishes for many miles of safe, pleasurable driving.

Mercedes-Benz USA, LLC

A Daimler Company

---

**Index . . . . . 3**

---

**Introduction . . . . . 19**

---

**At a glance . . . . . 25**

---

**Safety and security . . . . . 43**

---

**Controls in detail . . . . . 79**

---

**Operation . . . . . 237**

---

**Practical hints . . . . . 289**

---

**Technical data . . . . . 377**

## 1, 2, 3 ...

**4-ETS**

see ETS/4-ETS

**4MATIC**

see All-wheel drive (4MATIC)

**4-zone automatic climate control**

see Climate control system

## A

**ABS (Antilock Brake System)** . . . . . 71

Indicator lamp . . . . . 331

Messages in the multifunction

display . . . . . 297, 312

**Accessory weight** . . . . . 269**Accidents** . . . . . 127

Active head restraints . . . . . 60

Air bag deployment . . . . . 45

Distance warning function . . . . . 171

Emergency calls (Tele Aid) . . . . . 225

**Active Bi-Xenon headlamps**

Messages in the multifunction

display . . . . . 324

see Headlamps

**Active head restraints** . . . . . 60

Resetting . . . . . 345

**Adaptive Brake** . . . . . 72**Adaptive Damping System**

see ADS

**Additives**

Engine oil . . . . . 398

Gasoline . . . . . 400

**Address change** . . . . . 21**ADS (Adaptive Damping System)** . . . 171**Advanced Tire Pressure****Monitoring System (Advanced****TPMS)** . . . . . 257

Messages in the multifunction

display . . . . . 308, 328

**Air bags** . . . . . 45

Children . . . . . 45

Emergency call upon deployment . 225

Front, driver and passenger . . . . . 48

Front passenger front air bag off

indicator lamp . . . . . 53, 341

Messages in the multifunction

display . . . . . 299

Safety guidelines . . . . . 47

Side impact . . . . . 49

Window curtain . . . . . 50

**Air conditioning refrigerant and****lubricant** . . . . . 398**Air distribution** . . . . . 189**Air filter** . . . . . 323**AIRMATIC DC (Dual Control)**

ADS (Adaptive Damping System) . . 171

Introduction . . . . . 171

Messages in the multifunction

display . . . . . 314

Vehicle level control . . . . . 172

**Air pressure**

see Tire inflation pressure

**Air pressure (tires)** . . . . . 269**Air pump (electric)** . . . . . 292, 363**Air recirculation mode** . . . . . 192**Air volume** . . . . . 190**Alarm system**

see Anti-theft systems

**Alignment bolt (vehicle tool kit)**

. . . . . 290, 362

**All-wheel drive (4MATIC)** . . . . . 174**Alternator** . . . . . 390

Messages in the multifunction

display . . . . . 322

**AMG menu** . . . . . 144**Anticorrosion/antifreeze** . . . . . 401**Antilock Brake System**

see ABS

**Anti-theft systems** . . . . . 76

Anti-theft alarm system . . . . . 76

Immobilizer . . . . . 76

**Aquaplaning**

see Hydroplaning

**Ashtrays** . . . . . 222**Aspect ratio (tires)** . . . . . 269**Audio/DVD menu** . . . . . 146**Auto-dimming rear view mirrors** . . . 108

**Automatic central locking** . . . . . 85, 155  
**Automatic climate control**  
 see Climate control system  
**Automatic headlamp mode** . . . . . 111  
**Automatic interior lighting control** . . . 116  
**Automatic locking when driving** . . . . 155  
**Automatic shift program** . . . . . 133  
**Automatic transmission** . . . . . 130  
 Automatic shift program . . . . . 133  
 Emergency operation (limp-home mode) . . . . . 137  
 Gear range indicator . . . . . 133  
 Gear ranges . . . . . 133  
 Gear selector lever . . . . . 130  
 Gearshifting malfunctions (limp-home mode) . . . . . 137  
 Kickdown . . . . . 132  
 Kickdown (manual shift program) . . . 137  
 Manual shift program . . . . . 135  
 One-touch gearshifting . . . . . 134  
 Program mode indicator . . . . . 134  
 Program mode selector switch . . . . . 133, 135  
 Shifting procedure . . . . . 131  
 Steering wheel gearshift control . . . 134  
 Transmission position indicator . . . . 131  
 Transmission positions . . . . . 131  
**Axle oils** . . . . . 395

## B

**Backrest**  
 see Seats  
**Backup lamps**  
 Messages in the multifunction display . . . . . 324  
 Replacing bulbs . . . . . 348  
**Bar (air pressure unit)** . . . . . 269  
**BAS (Brake Assist System)** . . . . . 72  
**Batteries, SmartKey**  
 Checking condition . . . . . 84  
 Replacing . . . . . 346  
**Battery, Vehicle**  
 Charging . . . . . 368  
 Jump starting . . . . . 369  
 Messages in the multifunction display . . . . . 322  
**Bead (tire)** . . . . . 269  
**Beverage holders**  
 see Cup holders  
**Bleeding the fuel system (diesel engine)** . . . . . 366  
**Brake fluid**  
 Messages in the multifunction display . . . . . 313  
**Brake lamps**  
 Cleaning lenses . . . . . 285  
 High-mounted brake lamp . . . . . 348  
 Replacing bulbs . . . . . 348

## Brake pads

Messages in the multifunction display . . . . . 312

**Brakes** . . . . . 275  
 High-performance brake system . . . 277  
 Parking brake . . . . . 128  
 Warning lamp . . . . . 331  
**Break-in period** . . . . . 238

## Bulbs

see Replacing bulbs

## C

**CAC (Customer Assistance Center)** . . . 23  
**California retail buyers and lessees, important notice for** . . . . . 20  
**Calls (phone)** . . . . . 158  
**Can holders**  
 see Cup holders  
**Capacities and recommended fuel/lubricants** . . . . . 394  
**Cargo compartment**  
 Cover . . . . . 213  
 Net . . . . . 213  
 Storage box . . . . . 212  
**Cargo management system** . . . . . 210  
 Belt reels . . . . . 211  
 Cargo tie-down rings . . . . . 211  
 Mounting elements . . . . . 210  
 Telescoping rod . . . . . 212

- Cargo volume**
  - see Trunk/cargo compartment
- Carpets, cleaning** . . . . . 287
- Center console** . . . . . 37
- Central locking**
  - Automatic . . . . . 85, 155
  - Locking/unlocking from inside . . . . . 85
- Central locking/unlocking switch** . . . . . 85
- Certification label** . . . . . 379
- Children in the vehicle**
  - Air bags . . . . . 45
  - Blocking of rear window operation . . . . . 69
  - Child seat anchors – LATCH-type . . . . . 68
  - Indicator lamp, front passenger  
front air bag . . . . . 53
  - Infant and child restraint systems . . . . . 63
  - Occupant Classification System  
(OCS) . . . . . 50
  - Safety notes . . . . . 62
  - Tether anchorage points . . . . . 65
  - Top tether . . . . . 62
- Child safety**
  - see Children in the vehicle
- Child seat anchors – LATCH-type**
  - see Children in the vehicle
- Chrome-plated exhaust tip,  
cleaning** . . . . . 288
- Cigarette lighter** . . . . . 223
- Climate control**
  - see Climate control system
- Climate control system** . . . . . 179
  - 4-zone automatic climate control . . . . . 182
  - Air conditioning, cooling . . . . . 185
  - Air conditioning refrigerant . . . . . 398
  - Air distribution . . . . . 189
  - Air recirculation mode . . . . . 192
  - Air volume . . . . . 190
  - Automatic mode . . . . . 186
  - Deactivating system . . . . . 185
  - Front defroster . . . . . 190
  - Maximum cooling MAX COOL . . . . . 191
  - Residual engine heat (REST) . . . . . 192
  - Temperature . . . . . 186
- Clock** . . . . . 31, 152
- Cockpit** . . . . . 28
- Cold tire inflation pressure** . . . . . 269
- Collapsible tire (spare wheel)** . . . . . 389
- Collapsible wheel chock** . . . . . 290
- COMAND system**
  - see separate COMAND system
  - operating instructions
- Combination switch** . . . . . 113
- Control system** . . . . . 139
  - Multifunction display . . . . . 141
  - Multifunction steering wheel . . . . . 140
  - Resetting to factory settings . . . . . 149
- Control system menus** . . . . . 142
  - AMG . . . . . 144
  - Audio/DVD . . . . . 146
  - Distronic . . . . . 148
- Navigation . . . . . 148
- Settings . . . . . 149
- Standard display . . . . . 143
- Telephone . . . . . 158
- Trip computer . . . . . 156
- Vehicle status message memory . . . . . 148
- Control system submenus**
  - Convenience . . . . . 156
  - Instrument cluster . . . . . 151
  - Lighting . . . . . 153
  - Time/Date . . . . . 152
  - Vehicle . . . . . 155
- Convenience submenu**
  - Easy-entry/exit feature . . . . . 156
- Coolant**
  - Anticorrosion/antifreeze . . . . . 401
  - Capacities . . . . . 396
  - Checking level . . . . . 245
  - Messages in the multifunction  
display . . . . . 318, 319, 321
  - Temperature indicator . . . . . 138
  - Warning lamp . . . . . 339
- Corner-illuminating front fog lamps** . . . . . 115
- Cruise control** . . . . . 160
  - Last stored speed . . . . . 162
  - Resume function . . . . . 162
- Cup holders** . . . . . 219
- Curb weight** . . . . . 269
- Customer Assistance Center (CAC)** . . . . . 23

- D**
- Dashboard**
    - see Instrument cluster
  - Data recording** . . . . . 24
  - Date, Setting** . . . . . 153
  - Daytime running lamp mode** . . . 112, 153
  - Deep water**
    - see Standing water
  - Defroster**
    - Rear window . . . . . 193
    - Windshield . . . . . 190
  - Delayed shut-off**
    - Exterior lamps . . . . . 154
    - Interior lighting . . . . . 155
  - Department of Transportation**
    - see DOT
  - Diesel fuel**
    - see Fuel
  - Difficulties**
    - While driving . . . . . 127
    - With starting . . . . . 125
  - Digital clock**
    - see Clock
  - Digital speedometer** . . . . . 143
  - Dimensions (vehicle)** . . . . . 391
  - Direction of rotation (tires)** . . . . . 249
  - Displays**
    - Digital speedometer . . . . . 143
    - Distronic . . . . . 164
    - Maintenance service indicator . . . . . 280
    - Messages in the multifunction display . . . . . 295
    - Multifunction display . . . . . 141
    - Outside temperature . . . . . 143, 152
    - Symbol messages . . . . . 312
    - Text messages . . . . . 297
    - Trip computer . . . . . 156
    - Vehicle status message memory . . . 148
    - Vehicle system settings . . . . . 149
  - Distronic** . . . . . 162
    - Cleaning system sensor . . . . . 285
    - Control system . . . . . 148
    - Distance warning function . . . . . 171
    - Driving hints . . . . . 169
    - Menu . . . . . 165
    - Messages in the multifunction display . . . . . 304
    - Resume function . . . . . 168
    - Sensor cover . . . . . 285
    - Warning and indicator lamps . . . 165, 336
  - Door control panel** . . . . . 41
  - Door handles** . . . . . 41
  - Doors**
    - Locking/unlocking (KEYLESS-GO) . . . 81
    - Locking/unlocking (SmartKey) . . . . 80
    - Locking/unlocking from outside . . . 80
    - Messages in the multifunction display . . . . . 316
    - Opening from inside . . . . . 84
    - Remote door unlock (Tele Aid) . . . . 230
    - Unlocking (Mechanical key) . . . . . 343
  - DOT (Department of Transportation)** . . . . . 269
  - Drinking and driving** . . . . . 275
  - Driving**
    - Abroad . . . . . 278
    - Hydroplaning . . . . . 278
    - Instructions . . . . . 124, 274
    - In winter . . . . . 273
    - Problems . . . . . 127
    - Safety systems . . . . . 70
    - Systems . . . . . 160
    - Through standing water . . . . . 278
    - With DISTRONIC . . . . . 169
  - Driving and parking**
    - Safety notes . . . . . 124
  - Driving off** . . . . . 126, 277
  - Driving safety systems** . . . . . 70
    - ABS . . . . . 71
    - Adaptive Brake . . . . . 72
    - BAS . . . . . 72
    - EBP . . . . . 72
    - ESP® . . . . . 72
    - ETS/4-ETS . . . . . 73
  - Driving systems**
    - AIRMATIC DC (Dual Control) . . . . . 171
    - All-wheel drive (4MATIC) . . . . . 174
    - Cruise control . . . . . 160



Distronic . . . . .	162
Parktronic system . . . . .	175
<b>Driving tips, automatic transmission</b> . . . . .	132

## E

<b>Easy-entry/exit feature</b> . . . . .	106, 156
<b>EBP (Electronic Brake Proportioning)</b> . . . . .	72
<b>Electric air pump</b> . . . . .	292
<b>Electrical system</b>	
Improper work on or modifications . . . . .	22
Power outlets . . . . .	224
Technical data . . . . .	390
<b>Electronic Stability Program</b>	
see ESP®	
<b>Electronic Traction System</b>	
see ETS/4-ETS	
<b>Emergency, in case of</b>	
Battery, jump starting . . . . .	369
First aid kit . . . . .	290
Flat tire . . . . .	355
Hazard warning flasher . . . . .	114
Roadside Assistance . . . . .	21
Towing the vehicle . . . . .	372
<b>Emergency calls</b>	
Tele Aid . . . . .	225

**Emergency operations**

Gear selector lever, unlocking . . . . .	345
Limp-home mode . . . . .	137
Locking/unlocking the vehicle . . . . .	343
Remote door unlock . . . . .	230
Tailgate, unlocking and opening . . . . .	344
Trunk lid, emergency release . . . . .	92
Trunk lid, unlocking . . . . .	343

**Emergency Tensioning Device**

see ETD

<b>Emision control</b> . . . . .	279
Information label . . . . .	380
System warranties . . . . .	20

**Engine**

Brake-in recommendations . . . . .	238
Cleaning . . . . .	284
Compartment . . . . .	241
Malfunction indicator lamp . . . . .	31, 338
Maximum engine speed . . . . .	381
Messages in the multifunction display . . . . .	318
Number . . . . .	380
Starting . . . . .	124
Technical data . . . . .	381
Turning off . . . . .	129

**Engine coolant**

see Coolant

**Engine oil**

Adding . . . . .	244
Additives . . . . .	398
Checking level . . . . .	243
Consumption . . . . .	243
Messages in the multifunction display . . . . .	322
Oil dipstick . . . . .	243
Recommended engine oils and oil filter . . . . .	397

**ESP® (Electronic Stability Program)**

ETS . . . . .	73
Messages in the multifunction display . . . . .	297, 312
Warning lamp . . . . .	335

**ETD (Emergency Tensioning Device)**

Safety guidelines . . . . .	47
-----------------------------	----

**ETS/4-ETS (Electronic Traction System)****Express operation**

Panorama roof . . . . .	197
Power windows . . . . .	120
Tilt/sliding sunroof . . . . .	194

**Exterior lamp switch****Exterior rear view mirrors**

Parking position . . . . .	108, 109
----------------------------	----------

**Exterior view of vehicle**

- F**
- Fastening the seat belts** . . . . . 57
  - First aid kit** . . . . . 290
  - Flat tire** . . . . . 355
    - Lowering the vehicle . . . . . 365
    - Mounting the spare wheel . . . . . 360
    - Preparing the vehicle . . . . . 355
    - Spare wheel . . . . . 355, 389
    - TIREFIT (tire repair kit) . . . . . 355
  - Floormats** . . . . . 235
  - Fluids**
    - Automatic transmission fluid . . . . . 395
    - Brake fluid . . . . . 396
    - Capacities . . . . . 394
    - Engine coolant . . . . . 396
    - Engine oil . . . . . 394
    - Power steering fluid . . . . . 396
    - Washer and headlamp cleaning system . . . . . 397
  - Fog lamps** . . . . . 113
    - Messages in the multifunction display . . . . . 325, 326
    - Replacing bulbs . . . . . 348
  - Four-wheel drive**
    - see All-wheel drive (4MATIC)
  - Front air bags**
    - see Air bags
  - Front axle oil** . . . . . 395
- Front lamps**  
see Headlamps
- Front passenger front air bag** . . . . . 48
    - Messages in the multifunction display . . . . . 299
  - Front passenger front air bag off indicator lamp** . . . . . 49, 341
  - Fuel** . . . . . 274
    - Additives . . . . . 400
    - Capacity, fuel tank . . . . . 396
    - Diesel fuel . . . . . 240, 396
    - Fuel consumption statistics . . . . . 157
    - Fuel filler flap and cap . . . . . 240
    - Fuel tank reserve warning lamp . . . . . 31, 337
    - Premium unleaded gasoline . . . . . 240, 396, 398
    - Refueling . . . . . 239
    - Requirements . . . . . 399
  - Fuel filler flap** . . . . . 240
  - Fuels, coolants, lubricants etc.**
    - Capacities . . . . . 394
  - Fuel system, bleeding (diesel engine)** . . . . . 366
  - Fuel tank**
    - Capacity . . . . . 396
    - Fuel filler flap and cap . . . . . 240
    - Refueling . . . . . 239
  - Fuses** . . . . . 375
    - Fuse box in cargo compartment . . . . . 376
- G**
- Garage door opener** . . . . . 40, 231
  - Gasoline**
    - see Fuel
  - GAWR (Gross Axle Weight Rating)** . . . . . 269
  - Gear range**
    - Automatic transmission . . . . . 133
    - Indicator . . . . . 133
    - Limiting . . . . . 134
    - Shifting into optimal . . . . . 135
  - Gear selector lever** . . . . . 130
    - Cleaning . . . . . 287
    - Gearshift pattern . . . . . 130
    - Lock . . . . . 124, 130
    - Messages in the multifunction display . . . . . 307
    - Shifting procedure . . . . . 131
    - Transmission position indicator . . . . . 131
    - Transmission positions . . . . . 131
    - Unlocking in an emergency . . . . . 345
  - Generator**
    - see Alternator
  - Global locking/unlocking**
    - see Key, SmartKey
  - Glove box** . . . . . 217
  - Gross Axle Weight Rating**
    - see GAWR
  - Gross Vehicle Weight**
    - see GVW

- Gross Vehicle Weight Rating**  
see GVWR
- GVW (Gross Vehicle Weight)** . . . . . 269
- GVWR (Gross Vehicle Weight Rating)** . . . . . 269
- H**
- Halogen headlamps**  
see Headlamps
- Hard plastic trim items, cleaning** . . . 287
- Hazard warning flasher** . . . . . 114
- Headlamp cleaning system** . . . . . 114
- Headlamps**  
Active Bi-Xenon headlamps . . . . . 110  
Automatic headlamp mode . . . . . 111  
Bi-Xenon . . . . . 110, 348  
Cleaning lenses . . . . . 285  
Cleaning system . . . . . 114  
Delayed shut-off . . . . . 154  
Halogen . . . . . 349  
High-beam flasher . . . . . 114  
High-beam headlamps . . . . . 113  
Low-beam headlamps . . . . . 111  
Replacing bulbs . . . . . 348  
Switch . . . . . 111
- Headliner and shelf below rear window, cleaning and care of** . . . . . 287
- Head restraints** . . . . . 95  
Active head restraints . . . . . 60, 345  
Comfort head restraint, adjusting . . . 97  
Folding back . . . . . 98  
Rear seat, removing and installing . . 98
- Heated seats** . . . . . 102
- Heated steering wheel** . . . . . 106
- Height adjustment**  
Seat belt outlet . . . . . 57  
Seats . . . . . 96  
Vehicle level control . . . . . 172
- High-beam flasher** . . . . . 114
- High-beam headlamps** . . . . . 113, 348  
Indicator lamp . . . . . 31  
Replacing bulbs . . . . . 348
- High-mounted brake lamp** . . . . . 348  
Replacing bulbs . . . . . 348
- High-performance brake system** . . . 277
- Hood** . . . . . 241  
Messages in the multifunction display . . . . . 315
- Horn** . . . . . 29
- HVAC**  
see Climate control system
- Hydroplaning** . . . . . 278
- I**
- Identification labels** . . . . . 379
- Identification number, vehicle (VIN)** . . . . . 379
- Ignition** . . . . . 94, 95, 125
- Immobilizer** . . . . . 76
- Indicator lamps**  
see Lamps, indicator and warning
- Infant and child restraint systems**  
see Children in the vehicle
- Inflation pressure**  
see Tires, Inflation pressure
- Inside door handle** . . . . . 84
- Instrument cluster** . . . . . 30, 138  
Illumination . . . . . 138  
Lamps . . . . . 330  
Multifunction display . . . . . 141
- Instrument lighting**  
see Instrument cluster, Illumination
- Instrument panel**  
see Instrument cluster
- Instruments and controls**  
see Cockpit
- Interior lighting**  
Delayed shut-off . . . . . 155  
Front . . . . . 116  
Front reading lamps . . . . . 116  
Rear . . . . . 116  
Rear reading lamps . . . . . 116
- Interior rear view mirror** . . . . . 107  
Auto-dimming rear view mirrors . . . 108
- Interior storage spaces**  
see Storage compartments
- Intermittent wiping**  
Windshield wipers . . . . . 118

- J**
- Jack** . . . . . 292
  - Jump starting** . . . . . 369
- K**
- Key, Mechanical** . . . . . 343
    - Loss of . . . . . 84
    - Valet locking . . . . . 93
  - Key, SmartKey**
    - Battery check lamp . . . . . 81
    - Checking batteries . . . . . 84
    - Factory setting . . . . . 81, 83
    - Global locking (KEYLESS-GO)
      - . . . . . 83, 84
    - Global locking (SmartKey) . . . . . 81
    - Global unlocking (KEYLESS-GO)
      - . . . . . 83, 84
    - Global unlocking (SmartKey) . . . . . 81
    - Important notes on KEYLESS-GO . . . . . 82
    - Locking/unlocking . . . . . 80
    - Loss of . . . . . 84
    - Messages in the multifunction
      - display . . . . . 316
    - Opening, Trunk/tailgate . . . . . 86
    - Opening and closing the power
      - tilt/sliding sunroof or panorama
        - roof with power tilt/sliding panel . . . . . 122
      - Opening and closing the windows . . . . . 122
    - Remote control . . . . . 80
    - Replacing batteries . . . . . 346
    - Restoring to factory setting . . . . . 81, 84
    - Selective setting . . . . . 81, 84
    - Starter switch positions . . . . . 94
  - KEYLESS-GO**
    - Starter switch positions . . . . . 94
  - Kickdown** . . . . . 132
  - Kickdown (manual shift program)** . . . . . 137
  - Kilopascal (air pressure unit)** . . . . . 270
- L**
- Labels**
    - Certification . . . . . 379
    - Emission control information . . . . . 380
  - Lamps, exterior**
    - Exterior lamp switch . . . . . 111
    - Front . . . . . 348
    - Messages in the multifunction
      - display . . . . . 324
    - Rear . . . . . 348
    - Switching on/off . . . . . 111
  - Lamps, indicator and warning**
    - ABS . . . . . 31, 331
    - Battery (SmartKey) . . . . . 81
    - Brakes . . . . . 331
    - Coolant . . . . . 339
    - Distance warning lamp . . . . . 165, 171, 336
    - Engine malfunction . . . . . 31, 338
    - ESP® . . . . . 31, 335
    - Fog lamps . . . . . 113
    - Front passenger front air bag off
      - . . . . . 38, 49, 341
    - Fuel tank reserve . . . . . 31, 337
    - High-beam headlamps . . . . . 31
    - Instrument cluster . . . . . 330
    - Low-beam headlamps . . . . . 31
    - Low tire pressure/TPMS
      - malfunction telltale . . . . . 340
    - Seat belt telltale . . . . . 31, 58, 333
    - SRS . . . . . 45, 334
    - Turn signals . . . . . 31
  - Language, selecting** . . . . . 151
  - LATCH-type child seat anchors**
    - see Children in the vehicle
  - License plate lamps** . . . . . 348
    - Messages in the multifunction
      - display . . . . . 325
    - Replacing bulbs . . . . . 348
  - Light alloy wheels, cleaning** . . . . . 286
  - Lighter**
    - see Cigarette lighter
  - Lighting** . . . . . 110
    - Daytime running lamp mode . . . . . 112
    - Exterior . . . . . 111
    - Interior . . . . . 116
  - Limp-home mode** . . . . . 137
  - Loading**
    - see Vehicle loading
  - Locator lighting** . . . . . 154

- Lock button**
    - Door handle (KEYLESS-GO) . . . . . 83
  - Locking the vehicle** . . . . . 80, 81
    - Manually . . . . . 344
  - Loss of**
    - Key . . . . . 84
    - Service and Warranty Information booklet . . . . . 379
  - Low-beam headlamps** . . . . . 111
    - Exterior lamp switch . . . . . 111
    - Indicator lamp . . . . . 31
    - Replacing bulbs . . . . . 348
    - Switching on . . . . . 111
  - Lubricants** . . . . . 394
  - Luggage box** . . . . . 294
  - Lumbar support** . . . . . 98
- M**
- Maintenance** . . . . . 21
  - Maintenance System** . . . . . 280
    - Service indicator . . . . . 280
    - Service indicator, resetting . . . . . 281
    - Service indicator display . . . . . 281
    - Service indicator message . . . . . 280
    - Service indicator message, clearing . . . . . 281
    - Service term exceeded . . . . . 281
  - Manual headlamp mode (Low-beam headlamps)** . . . . . 111
  - Manual shift program** . . . . . 135
  - Maximum loaded vehicle weight** . . . . . 270
  - Maximum load rating (tires)** . . . . . 270
  - Maximum permissible tire inflation pressure** . . . . . 270
  - Mechanical key** . . . . . 343
  - Memory function** . . . . . 109
  - Menus**
    - see Control system menus
  - Minispare wheel**
    - see Spare wheel
  - Mirrors**
    - Auto-dimming rear view mirrors . . . . . 108
    - Exterior rear view mirror parking positions . . . . . 108, 109
    - Exterior rear view mirrors . . . . . 107
    - Interior rear view mirror . . . . . 107
    - Memory function . . . . . 109
  - MON (Motor Octane Number)** . . . . . 399
  - Motor Octane Number**
    - see MON
  - Multicontour seats** . . . . . 101
  - Multifunction display** . . . . . 141
    - Symbol messages . . . . . 312
    - Text messages . . . . . 297
    - Vehicle status messages . . . . . 295
  - Multifunction display messages**
    - ABS . . . . . 297, 312
    - Active headlamps . . . . . 324
    - Advanced TPMS . . . . . 308, 328
    - Air bags . . . . . 299
    - Air filter . . . . . 323
    - AIRMATIC DC (Dual Control) . . . . . 314
    - Alternator . . . . . 322
    - Automatic transmission . . . . . 307
    - Backrests . . . . . 316
    - Battery . . . . . 322
    - Brake fluid . . . . . 313
    - Brake pads . . . . . 312
    - Cargo compartment . . . . . 315
    - Check engine . . . . . 318
    - Coolant . . . . . 318, 319, 321
    - Corner-illuminating front fog lamps . . . . . 327
    - Cruise control . . . . . 304
    - Display malfunction . . . . . 295
    - Distronic . . . . . 304
    - Doors . . . . . 316
    - EBP . . . . . 312
    - Engine oil . . . . . 322
    - Engine service . . . . . 318
    - ESP® . . . . . 297, 312
    - Fog lamps . . . . . 325, 326
    - Front passenger front air bag . . . . . 299
    - Gas cap . . . . . 323
    - Gear selector lever . . . . . 307
    - High-beam lamps . . . . . 325
    - Hood . . . . . 315
    - License plate lamps . . . . . 325
    - Light sensor . . . . . 326

- Low-beam lamps . . . . . 326
  - Parking brake . . . . . 312
  - Parking lamps . . . . . 325
  - PRE-SAFE® . . . . . 298
  - Reserve fuel . . . . . 323
  - Reverse lamp . . . . . 324
  - Side marker lamps . . . . . 325
  - SmartKey . . . . . 316
  - SmartKey with KEYLESS-GO . . . . . 316
  - SRS . . . . . 314
  - Tailgate . . . . . 315
  - Tail lamps . . . . . 326
  - Tele Aid . . . . . 314
  - Tire pressure . . . . . 307, 328
  - Tire pressure monitor . . . . . 308
  - Tires . . . . . 307, 328
  - TPMS . . . . . 308, 328
  - Trunk . . . . . 315
  - Turn signals . . . . . 327
  - Washer fluid . . . . . 317
  - Multifunction steering wheel**
    - Adjusting . . . . . 105
    - Buttons . . . . . 140
    - Cleaning . . . . . 287
    - Easy-entry/exit feature . . . . . 106, 156
    - Gearshift control . . . . . 134
    - Heating . . . . . 106
    - Memory function . . . . . 109
    - Overview . . . . . 35
- N**
- Navigation menu** . . . . . 148
  - Net, parcel** . . . . . 204
  - Night security illumination** . . . . . 113, 154
  - Normal occupant weight** . . . . . 270
  - Number, vehicle identification (VIN)** . . . . . 379
- O**
- Occupant Classification System**
    - see OCS
  - Occupant distribution** . . . . . 270
  - Occupant safety** . . . . . 44
    - Air bags . . . . . 45
    - Children and air bags . . . . . 45
    - Children in the vehicle . . . . . 62
    - Child seat anchors – LATCH-type . . . . . 68
    - Fastening the seat belts . . . . . 57
    - Front passenger front air bag off indicator lamp . . . . . 51, 341
    - Infant and child restraint systems . . . . . 63
    - OCS . . . . . 50
    - PRE-SAFE® . . . . . 59
    - Seat belts . . . . . 47, 55
  - OCS (Occupant Classification System)** . . . . . 50
    - Self-test . . . . . 54
  - Odometer** . . . . . 141
- Oil**
- see Engine oil
- Oil level**
- see Engine oil, Checking level
- On-board computer**
- see Control system
- One-touch gearshifting** . . . . . 134
- Operating safety** . . . . . 22
- Ornamental moldings, cleaning** . . . . . 284
- Outside temperature**
- see Displays
- Overhead control panel** . . . . . 40
- P**
- Paintwork, cleaning** . . . . . 283
  - Paintwork code** . . . . . 379
  - Panic alarm** . . . . . 70
  - Panorama roof with power tilt/sliding panel** . . . . . 197
    - Cleaning . . . . . 286
    - Operation . . . . . 197
    - Roller sunblinds . . . . . 197
    - Synchronizing . . . . . 199
  - Parcel net** . . . . . 204
  - Parking** . . . . . 128
    - Parktronic system . . . . . 175
  - Parking brake** . . . . . 128
    - Messages in the multifunction display . . . . . 312

- Parking position**
    - Exterior rear view mirrors . . . 108, 109
    - Transmission position . . . . . 131
  - Parktronic system**
    - Cleaning system sensors . . . . . 285
    - Malfunctions . . . . . 178
    - Minimum distance . . . . . 176
    - Range . . . . . 176
    - System sensors . . . . . 175
    - Warning indicators . . . . . 29, 176
  - Parts service** . . . . . 378
  - PASS AIR BAG OFF indicator lamp**
    - see Front passenger front air bag off indicator lamp
  - Passenger safety**
    - see Occupant safety
  - Pedals** . . . . . 275
  - Phone**
    - see Telephone
  - Plastic parts, cleaning** . . . . . 287
  - Power assistance** . . . . . 275
  - Power outlets** . . . . . 224
  - Power seats**
    - see Seats
  - Power tilt/sliding sunroof**
    - Operation . . . . . 194
    - Synchronizing . . . . . 196
  - Power washer** . . . . . 283
  - Power windows** . . . . . 120
    - Cleaning . . . . . 285
    - Operation . . . . . 120
    - Rear door window, Blocking operation . . . . . 69
    - Synchronizing . . . . . 122
  - Practical hints** . . . . . 290
  - Preglow indicator lamp** . . . . . 125
  - PRE-SAFE®** . . . . . 59
    - Messages in the multifunction display . . . . . 298
  - Problems**
    - While driving . . . . . 127
    - With vehicle . . . . . 23
  - Product information** . . . . . 19
  - Production options weight** . . . . . 270
  - Program mode selector switch**
    - Automatic shift program . . . . . 133
    - Manual shift program . . . . . 135
  - Proximity key**
    - see Key, SmartKey
  - PSI (air pressure unit)** . . . . . 270
  - Push-start**
    - see Tow-start
- 
- R
- RACETIMER** . . . . . 145
  - Radio**
    - Selecting stations . . . . . 147
  - Radio transmitters** . . . . . 278
  - Rain sensor** . . . . . 118
  - Rear axle oil** . . . . . 395
  - Rear door ashtray**
    - see Ashtrays
  - Rear door window**
    - Blocking operation . . . . . 69
  - Rear fog lamp**
    - see Fog lamps
  - Rear lamps**
    - see Tail lamps
  - Rear seat head restraints**
    - see Head restraints
  - Rear window defroster** . . . . . 193
  - Rear window wiper/washer** . . . . . 119
  - Recommended tire inflation pressure** . . . . . 253, 270
  - Recovery services, Stolen vehicle (Tele Aid)** . . . . . 231
  - Refrigerant, air conditioning** . . . . . 398
  - Refueling** . . . . . 239
  - Regular checks** . . . . . 241
  - Reminder, Seat belt**
    - see Seat belts, Telltale
  - Remote control**
    - see Key, SmartKey
  - Remote door unlock (Tele Aid)** . . . . . 230
  - Replacing bulbs** . . . . . 348
  - Reporting safety defects** . . . . . 23
  - Research Octane Number**
    - see RON

- Reserve fuel**
    - Messages in the multifunction display . . . . . 323
  - Reset button** . . . . . 31, 138
  - Reset tool (active head restraints)** . 346
  - Restraint systems**
    - see Occupant safety
  - Retaining hook** . . . . . 204
  - Rims** . . . . . 270, 384
  - Roadside Assistance** . . . . . 21, 226
  - Roller sunblinds** . . . . . 221
  - RON (Research Octane Number)** . . . 399
  - Roof rack** . . . . . 201
  - Route guidance**
    - see Navigation system
  - Rubber parts, cleaning** . . . . . 287
  - Run Flat Indicator** . . . . . 256
- 
- S
- Safety**
    - Driving safety systems . . . . . 70
    - Occupant safety . . . . . 44
    - Reporting defects . . . . . 23
  - Safety belts**
    - see Seat belts
  - Seat belt force limiter** . . . . . 58
  - Seat belts** . . . . . 55
    - Automatic comfort-fit feature . . . . . 59
    - Children in the vehicle . . . . . 62
    - Cleaning . . . . . 287
    - Fastening . . . . . 57
    - Height adjustment . . . . . 57
    - Proper use of . . . . . 55
    - Safety guidelines . . . . . 47
    - Safety notes . . . . . 55
    - Telltale . . . . . 31, 333
    - Warning lamp . . . . . 333
  - Seat cushions**
    - Removing and installing . . . . . 103
  - Seating capacity** . . . . . 250
  - Seats** . . . . . 95
    - Adjusting . . . . . 96
    - Easy-entry/exit feature . . . . . 106
    - Folding (expanding cargo volume) . 205
    - Heating . . . . . 102
    - Memory function . . . . . 109
    - Messages in the multifunction display . . . . . 316
    - Multicontour seat . . . . . 101
    - Seat bench, folding . . . . . 205
    - Seat cushions . . . . . 103
    - Split rear seat bench . . . . . 205
    - Third-row . . . . . 102
    - Ventilation . . . . . 101
  - Securing cargo**
    - Cargo tie-down rings . . . . . 204
  - Selective setting**
    - see Key, SmartKey
  - Selector lever**
    - see Gear selector lever
  - Self-test**
    - OCS . . . . . 54
    - Tele Aid . . . . . 225
  - Service**
    - see Maintenance
  - Service, parts** . . . . . 378
  - Service and warranty information** . . . 20
  - Service intervals**
    - see Maintenance System, Service indicator
  - Service life (tires)** . . . . . 248
  - Settings**
    - Date . . . . . 153
    - Factory setting (SmartKey) . . . . . 81, 83
    - Individual (vehicle) . . . . . 149
    - Memory function . . . . . 109
    - Menu . . . . . 149
    - Selective setting (SmartKey) . . . . . 81, 84
    - Time . . . . . 152
  - Shelf below rear window, cleaning** . 287
  - Side impact air bags** . . . . . 49
  - Side marker lamps**
    - Cleaning lenses . . . . . 285
    - Messages in the multifunction display . . . . . 325
    - Replacing bulbs . . . . . 348
  - Sidewall (tires)** . . . . . 270



- Side windows**
    - see Power windows
  - Ski bag** . . . . . 202
  - SmartKey**
    - see Key, SmartKey
  - SmartKey with KEYLESS-GO**
    - see Key, SmartKey
  - Snow chains** . . . . . 273
  - Snow tires**
    - see Winter tires
  - Spare wheel** . . . . . 293, 384
    - Mounting . . . . . 360
  - Speedometer** . . . . . 31, 164
  - Speed settings**
    - Distronic . . . . . 167
    - Resume function . . . . . 168
  - Split rear seat bench**
    - see Vehicle loading
  - SRS** . . . . . 45
    - Indicator lamp . . . . . 31, 45, 334
    - Messages in the multifunction display . . . . . 314
  - Standing water, driving through** . . . 278
  - Starter switch positions** . . . . . 94
  - Starting difficulties (engine)** . . . . . 125
  - Starting the engine** . . . . . 124
  - Steering column**
    - see Multifunction steering wheel, Adjusting
  - Steering wheel**
    - see Multifunction steering wheel
  - Steering wheel gearshift control** . . . 134
  - Stolen Vehicle Recovery services** . . 231
  - Storage compartments** . . . . . 32, 217
  - Storing tires** . . . . . 249
  - Sunroof**
    - see Power tilt/sliding sunroof
  - Sunshade, rear window** . . . . . 222
  - Sun visors** . . . . . 221
  - Suspension tuning**
    - see AIRMATIC DC (Dual Control)
- T**
- Tachometer** . . . . . 31, 139
    - Overspeed range . . . . . 139
  - Tailgate**
    - Messages in the multifunction display . . . . . 315
    - see Trunk/tailgate
  - Tail lamps** . . . . . 348
    - Cleaning lenses . . . . . 285
    - Messages in the multifunction display . . . . . 326
    - Replacing bulbs . . . . . 348
  - Tar stains** . . . . . 283
  - Technical data**
    - Air conditioning refrigerant . . 396, 398
    - Brake fluid . . . . . 396, 398
    - Capacities fuels, coolants, lubricants etc. . . . . 394
    - Coolant . . . . . 396, 400
    - Dimensions . . . . . 391
    - Electrical system . . . . . 390
    - Engine . . . . . 381
    - Engine oil additives . . . . . 398
    - Engine oils . . . . . 394, 397
    - Fuel requirements . . . . . 399
    - Gasoline additives . . . . . 400
    - Identification labels . . . . . 379
    - Premium unleaded gasoline . . . . 398
    - Rims and tires . . . . . 384
    - Spare wheel . . . . . 389
    - Washer and headlamp cleaning system . . . . . 397, 402
    - Weights . . . . . 393
  - Tele Aid** . . . . . 224
    - Emergency calls . . . . . 225
    - Information button . . . . . 227
    - Initiating an emergency call manually . . . . . 226
    - Messages in the multifunction display . . . . . 314
    - Remote door unlock . . . . . 230
    - Roadside Assistance button . . . . 226
    - Search and send . . . . . 229
    - SOS button . . . . . 226
    - Stolen Vehicle Recovery services . 231
    - System self-test . . . . . 225

- Telephone** . . . . . 35
  - Answering/ending a call . . . . . 158
  - Hands-free microphone . . . . . 40
  - Menu . . . . . 158
  - Operation . . . . . 158
  - Phone book . . . . . 159
  - Redialing . . . . . 159
- Temperature**
  - Coolant . . . . . 138
  - Interior temperature . . . . . 186
  - Outside . . . . . 143, 152
- Tether anchorage points**
  - see Children in the vehicle
- Tie-down rings** . . . . . 204
- Tightening torque**
  - Spark plugs . . . . . 390
  - Wheels . . . . . 365
- Time setting** . . . . . 152
- TIN (Tire Identification Number)** . . . . . 270
- Tire and Loading Information**
- Placard** . . . . . 249
- Tire and loading terminology** . . . . . 269
- TIREFIT** . . . . . 355
- Tire Identification Number**
  - see TIN
- Tire inflation pressure**
  - Checking . . . . . 255
  - Important notes on . . . . . 254
  - Placard on driver's door B-pillar . . . . . 249
- Tire labeling** . . . . . 261
- Tire load rating** . . . . . 271
- Tire ply composition and material used** . . . . . 271
- Tire Pressure Monitoring System (TPMS)** . . . . . 257
  - Messages in the multifunction display . . . . . 308, 328
- Tire repair kit**
  - see TIREFIT
- Tires** . . . . . 247, 384
  - Advanced Tire Pressure Monitoring System (Advanced TPMS) . . . . . 257
  - Advanced TPMS low tire pressure telltale . . . . . 340
  - Air pressure . . . . . 253
  - Care and maintenance . . . . . 248
  - Cleaning . . . . . 249
  - Direction of rotation, spinning . . . . . 249
  - Important notes on tire inflation pressure . . . . . 254
  - Inflation pressure . . . . . 254, 255
  - Information placard . . . . . 249
  - Inspection . . . . . 248
  - Labeling . . . . . 261
  - Load rating . . . . . 271
  - Messages in the multifunction display . . . . . 307, 328
  - Ply composition and material used . . . . . 271
  - Problems under-/overinflation . . . . . 254
  - Retreads . . . . . 247
  - Rims and tires (technical data) . . . . . 384
  - Rotation . . . . . 271
  - Run Flat Indicator . . . . . 256
  - Service life . . . . . 248
  - Sizes . . . . . 384, 385
  - Snow chains . . . . . 273
  - Speed rating . . . . . 263, 271
  - Storing . . . . . 249
  - Temperature . . . . . 254, 268
  - Terminology . . . . . 269
  - TIREFIT (tire repair kit) . . . . . 355
  - Tire Identification Number . . . . . 270
  - Tire Pressure Monitoring System (TPMS) . . . . . 257
  - TPMS low tire pressure/malfunction telltale . . . . . 340
  - Traction . . . . . 268, 271
  - Tread . . . . . 271
  - Tread depth . . . . . 248, 272
  - Treadwear indicators . . . . . 248, 271
  - Vehicle maximum load on . . . . . 271
  - Wear pattern . . . . . 271
  - Winter tires . . . . . 272, 384
- Tire speed rating** . . . . . 263, 271
- Top tether**
  - see Children in the vehicle
- Total load limit** . . . . . 271
- Towing eye bolt** . . . . . 372
- Towing the vehicle** . . . . . 372

- Tow-start** ..... 369, 372
- Traction** ..... 271
- Transmission**  
see Automatic transmission
- Transmission fluid level** ..... 245
- Transmission gear selector lever**  
see Gear selector lever
- Transmission positions** ..... 131
- Traveling abroad** ..... 278
- Tread (tires)** ..... 271
- Tread depth (tires)** ..... 248, 272
- Treadwear indicators (tires)** ... 248, 271
- Trip computer menu** ..... 156
- Trip odometer, resetting** ..... 139
- Trunk**  
Fuse box ..... 376  
Trunk lid emergency release ..... 92
- Trunk/cargo compartment**  
Cargo volume, expanding ..... 205  
Fuse box ..... 376  
Third-row seats ..... 102  
Tie-down rings ..... 204
- Trunk/tailgate**  
Closing ..... 89  
Messages in the multifunction display ..... 315  
Opening ..... 86  
Opening/closing system ..... 87, 91, 92
- Unlocking in an emergency ..... 343  
Valet locking ..... 93
- Turning off the engine** ..... 129
- Turn signals** ..... 114  
Additional in mirrors ..... 348  
Bulbs ..... 348  
Cleaning lenses ..... 285  
Indicator lamps ..... 31  
Messages in the multifunction display ..... 327  
Replacing bulbs ..... 348
- Twin roller blind** ..... 213
- U**
- Uniform Tire Quality Grading Standards** ..... 267, 271
- Units, Settings**  
Speedometer ..... 151
- Unleaded gasoline, premium** ..... 398
- Unlocking the vehicle** ..... 80, 81  
Manually ..... 343
- Upholstery, cleaning** ..... 287
- Useful features** ..... 219
- V**
- Valet locking** ..... 93
- Vehicle**  
Battery ..... 367  
Care ..... 282
- Control system ..... 139  
Dimensions ..... 391  
Individual settings ..... 149  
Locking/unlocking ..... 80, 81  
Locking/unlocking manually ..... 343  
Lowering (wheel change) ..... 365  
Modifications and alterations, Operating safety ..... 22  
Towing ..... 372
- Vehicle jack**  
see Jack
- Vehicle level control**  
see AIRMATIC DC (Dual Control)
- Vehicle lighting** ..... 110
- Vehicle loading**  
Cargo tie-down rings ..... 204  
Instructions ..... 200  
Load limit ..... 251  
Roof rack ..... 201  
Ski bag ..... 202  
Split rear seat bench ..... 205  
Terminology ..... 269
- Vehicle maximum load on the tire** .. 271
- Vehicle Recovery services, Stolen (Tele Aid)** ..... 231
- Vehicle status message memory** ... 148
- Vehicle tool kit** ..... 290
- Vehicle washing**  
see Vehicle care

## W

**Warning lamps**

see Lamps, Indicator and warning

**Warning sounds**

- Distance warning function . . . . . 171
- DISTRONIC . . . . . 165
- Driver's or passenger's seat belt . . . 58
- Parking brake . . . . . 312
- Parktronic system . . . . . 178
- Seat belt telltale . . . . . 333

**Warranty coverage** . . . . . 378

**Washer and headlamp cleaning**

**system** . . . . . 402

**Washer fluid**

- Messages in the multifunction display . . . . . 317
- Mixing ratio . . . . . 402
- Refilling . . . . . 246
- Wiping . . . . . 119

**Washing the vehicle** . . . . . 282

**Wear pattern (tires)** . . . . . 271

**Wheel**

- Changing . . . . . 355
- Removing . . . . . 362
- Spare . . . . . 355
- Tightening torque . . . . . 365

**Wheels, sizes** . . . . . 384, 385

**Wheels, Tires and** . . . . . 247

**Window curtain air bags** . . . . . 50

**Windows**

see Power windows

**Windows, cleaning** . . . . . 285

**Windshield**

- Cleaning wiper blades . . . . . 285
- Washer fluid . . . . . 119, 402
- Wipers . . . . . 118

**Windshield wipers**

- Rain sensor . . . . . 118
- Replacing wiper blades . . . . . 352

**Winter driving**

- Snow chains . . . . . 273
- Tires . . . . . 272

**Winter driving instructions** . . . . . 273

**Winter tires** . . . . . 272, 384

**Wood trims, cleaning** . . . . . 288

## Product Information

Please observe the following in your own best interest:

We recommend using Genuine Mercedes-Benz Parts as well as conversion parts and accessories explicitly approved by us for your vehicle model.

We have tested these parts to determine their reliability, safety and special suitability for Mercedes-Benz vehicles.

We are unable to make an assessment for other products and therefore cannot be held responsible for them, even if in individual cases an official approval or authorization by governmental or other agencies should exist. Use of such parts and accessories could adversely affect the safety, performance or reliability of your vehicle. Please do not use them.

Genuine Mercedes-Benz Parts and pre-approved conversion parts and accessories are available at any authorized Mercedes-Benz Center. In addition, you will receive comprehensive information on permissible technical modifications and expert installations.

## Operator's Manual

### Notes

This Operator's Manual contains a great deal of useful information. We urge you to read it carefully and familiarize yourself with the vehicle before driving.

For your own safety and longer service life of the vehicle, we urge you to follow the instructions and warnings contained in this Operator's Manual. Ignoring them could result in damage to the vehicle or personal injury to you or others. Vehicle damage caused by failure to follow instructions is not covered by the Mercedes-Benz Limited Warranty.

We continuously strive to improve our product, and ask for your understanding that we reserve the right to make changes in design and equipment. Therefore, information, illustrations and descriptions in this Operator's Manual might differ from your vehicle.

## Vehicle equipment

Your vehicle may have some or all of the equipment described in this manual.

Therefore, you may find explanations for optional equipment not installed in your vehicle. If you have any questions about operating any equipment, any authorized Mercedes-Benz Center will be glad to demonstrate the proper procedures.

Optional equipment is also described in this manual, including operating instructions wherever necessary. Since they are special-order items, the descriptions and illustrations herein may vary slightly from the actual equipment of your vehicle.

If there are any equipment details that are not shown or described in this Operator's Manual, any authorized Mercedes-Benz Center will be glad to inform you of correct care and operating procedures. The Operator's Manual and Maintenance Booklet are important documents and should be kept with the vehicle.

## Operator's Manual

### Service and warranty information

The Service and Warranty Information booklet contains detailed information about the warranties covering your Mercedes-Benz, including:

- New Car Limited Warranty
- Emission System Warranty
- Emission Performance Warranty
- California, Connecticut, Maine, Massachusetts, New York, Pennsylvania, Rhode Island, and Vermont Emission Control System Warranty<sup>1</sup>
- State Warranty Enforcement Laws (Lemon Laws)

### Important notice for California retail buyers and lessees of Mercedes-Benz automobiles

Under California law you may be entitled to a replacement of your vehicle or a refund of the purchase price or lease price, if after a reasonable number of repair attempts Mercedes-Benz USA, LLC and/or its authorized repair or service facilities fail to fix one or more substantial defects or malfunctions in the vehicle that are covered by its express warranty. During the period of 18 months from original delivery of the vehicle or the accumulation of 18 000 miles (approximately 29 000 km) on the odometer of the vehicle, whichever occurs first, a reasonable number of repair attempts is presumed for a retail buyer or lessee if one or more of the following occurs:

- (1) the same substantial defect or malfunction results in a condition that is likely to cause death or serious bodily injury if the vehicle is driven, that defect or malfunction has been subject to repair two or more times, and you have directly

notified Mercedes-Benz USA, LLC in writing of the need for its repair,

- (2) the same substantial defect or malfunction of a less serious nature than category (1) has been subject to repair four or more times and you have directly notified us in writing of the need for its repair, or
- (3) the vehicle is out of service by reason of repair of the same or different substantial defects or malfunctions for a cumulative total of more than 30 calendar days.

Written notification should not be sent to a dealer, it should be addressed to Mercedes-Benz USA, LLC Customer Assistance Center One Mercedes Drive Montvale, NJ 07645-0350

<sup>1</sup> Applicable to vehicles with gasoline engine only.

### Maintenance

The Maintenance Booklet describes all the necessary maintenance work which should be performed at regular intervals.

Always have the Maintenance Booklet with you when you take the vehicle to an authorized Mercedes-Benz Center for service. The service advisor will record each service in the booklet for you.

### Roadside Assistance

The Mercedes-Benz Roadside Assistance Program provides factory-trained technical help in the event of a breakdown. Calls to the toll-free Roadside Assistance number

**1-800-FOR-MERCEdes (in the USA)**  
**1-800-387-0100 (in Canada)**

will be answered by Mercedes-Benz Customer Assistance Representatives 24 hours a day, 365 days a year.

For additional information refer to the Mercedes-Benz Roadside Assistance Program brochure (in the USA) or the Roadside Assistance section of the Service and Warranty Information Booklet (in Canada) in your vehicle literature portfolio.

### Change of address or ownership

If you change your address, be sure to send in the "Change of Address Notice" found in the Service and Warranty Information Booklet, or simply call the Mercedes-Benz Customer Assistance Center (in the USA) at 1-800-FOR-MERCEdes, or Customer Service (in Canada) at 1-800-387-0100. This will assist us in contacting you in a timely manner should the need arise.

If you sell your Mercedes, please leave all literature with the vehicle to make it available to the next operator.

If you bought this vehicle used, be sure to send in the "Notice of Purchase of Used Car" found in the Service and Warranty Information Booklet, or call the Mercedes-Benz Customer Assistance Center (in the USA) at 1-800-FOR-MERCEdes, or Customer Service (in Canada) at 1-800-387-0100.

### Operating your vehicle outside the USA or Canada

If you plan to operate your vehicle in foreign countries, please be aware that:

- service facilities or replacement parts may not be readily available,
- unleaded gasoline for vehicles with catalytic converters may not be available; the use of leaded fuels will damage the catalysts,
- gasoline may have a considerably lower octane rating, and improper fuel can cause engine damage.

Certain Mercedes-Benz models are available for delivery in Europe under our European Delivery Program. For details, consult an authorized Mercedes-Benz Center or write to:

#### In the USA:

Mercedes-Benz USA, LLC  
 European Delivery Department  
 One Mercedes Drive  
 Montvale, NJ 07645-0350

#### In Canada:

Mercedes-Benz Canada, Inc.  
 European Delivery Department  
 98 Vanderhoof Avenue  
 Toronto, Ontario M4G 4C9

## Operating safety

### Operating safety

#### **Warning!**

Work improperly carried out on electronic components and associated software could cause them to cease functioning. Because the vehicle's electronic components are interconnected, any modifications made may produce an undesired effect on other systems. Electronic malfunctions could seriously impair the operating safety of your vehicle. Contact an authorized Mercedes-Benz Center for repairs or modifications to electronic components.

Other improper work or modifications on the vehicle could also have a negative impact on the operating safety of the vehicle.

Some safety systems only function while the engine is running. You should therefore never turn off the engine while driving.

#### **Warning!**

Heavy blows against the vehicle underbody or tires/wheels, for example when running over an obstacle, road debris or a pothole,

may cause serious damage and impair the operating safety of your vehicle. If you feel a sudden significant vibration or ride disturbance, or you suspect that damage to your vehicle has occurred, you should turn on your hazard warning flashers, carefully slow down, and drive with caution to an area which is a safe distance from the road.

Inspect the vehicle underbody and tires/wheels for possible damage. If the vehicle appears unsafe, have it towed to the nearest authorized Mercedes-Benz Center or other qualified maintenance or repair facility for further inspection or repairs.

### Proper use of the vehicle

Proper use of the vehicle requires that you are familiar with the following information and rules:

- the safety precautions in this manual
- the "Technical data" section in this manual
- traffic rules and regulations
- motor vehicle laws and safety standards

#### **Warning!**

Various warning labels are attached to your vehicle. These warning labels are intended

to make you and others aware of various risks. You should not remove any of these warning labels unless explicitly instructed to do so by information on the label itself. Removal of any of these labels may cause you and others to be unaware of certain risks which may result in an accident and/or personal injury.



**Reporting safety defects****Problems with your vehicle**

If you should experience a problem with your vehicle, particularly one that you believe may affect its safe operation, we urge you to contact an authorized Mercedes-Benz Center immediately to have the problem diagnosed and corrected if required. If the matter is not handled to your satisfaction, please discuss the problem with the Mercedes-Benz Center management or, if necessary, contact us at one of the following addresses:

**In the USA:**

Customer Assistance Center  
Mercedes-Benz USA, LLC  
One Mercedes Drive  
Montvale, NJ 07645-0350

**In Canada:**

Customer Relations Department  
Mercedes-Benz Canada, Inc.  
98 Vanderhoof Avenue  
Toronto, Ontario M4G 4C9

**Reporting safety defects**

For the USA only:

The following text is published as required of manufacturers under Title 49, Code of U.S. Federal Regulations, Part 575 pursuant to the “National Traffic and Motor Vehicle Safety Act of 1966”.

**Reporting safety defects**

If you believe that your vehicle has a defect which could cause a crash or could cause injury or death, you should immediately inform the National Highway Traffic Safety Administration (NHTSA) in addition to notifying Mercedes-Benz USA, LLC.

If NHTSA receives similar complaints, it may open an investigation, and if it finds that a safety defect exists in a group of vehicles, it may order a recall and remedy campaign. However, NHTSA cannot become involved in individual problems between you, your dealer, or Mercedes-Benz USA, LLC.

To contact NHTSA, you may call the Vehicle Safety Hotline toll-free at 1-888-327-4236 (TTY: 1-800-424-9153); go to

**[www.safercar.gov](http://www.safercar.gov)**; or write to:

Administrator, NHTSA Headquarters,

1200 New Jersey Avenue, SE, West Building,  
Washington, DC 20590.

You can also obtain other information about motor vehicle safety from **[www.safercar.gov](http://www.safercar.gov)**.

## Vehicle data recording

### Vehicle data recording

#### Information regarding electronic recording devices

(Including notice pursuant to California Code § 9951)

Please note that your vehicle is equipped with devices that can record vehicle systems data and, if equipped with the Tele Aid system, may transmit some data in certain accidents.

This information helps, for example, to diagnose vehicle systems after a collision and to continuously improve vehicle safety. Daimler may access the information and share it with others

- for safety research or vehicle diagnosis purposes
- with the consent of the vehicle owner or lessee
- in response to an official request by law enforcement or other government agency
- for use in dispute resolution involving Daimler, its affiliates or sales/service organization and/or
- as otherwise required or permitted by law.

Please check the Tele Aid subscription service agreement for details regarding the

information that may be recorded or transmitted via that system.

Exterior view .....	26
Cockpit .....	28
Instrument cluster .....	30
Storage compartments .....	32
Multifunction steering wheel .....	35
Center console .....	37
Overhead control panel .....	40
Door control panel .....	41



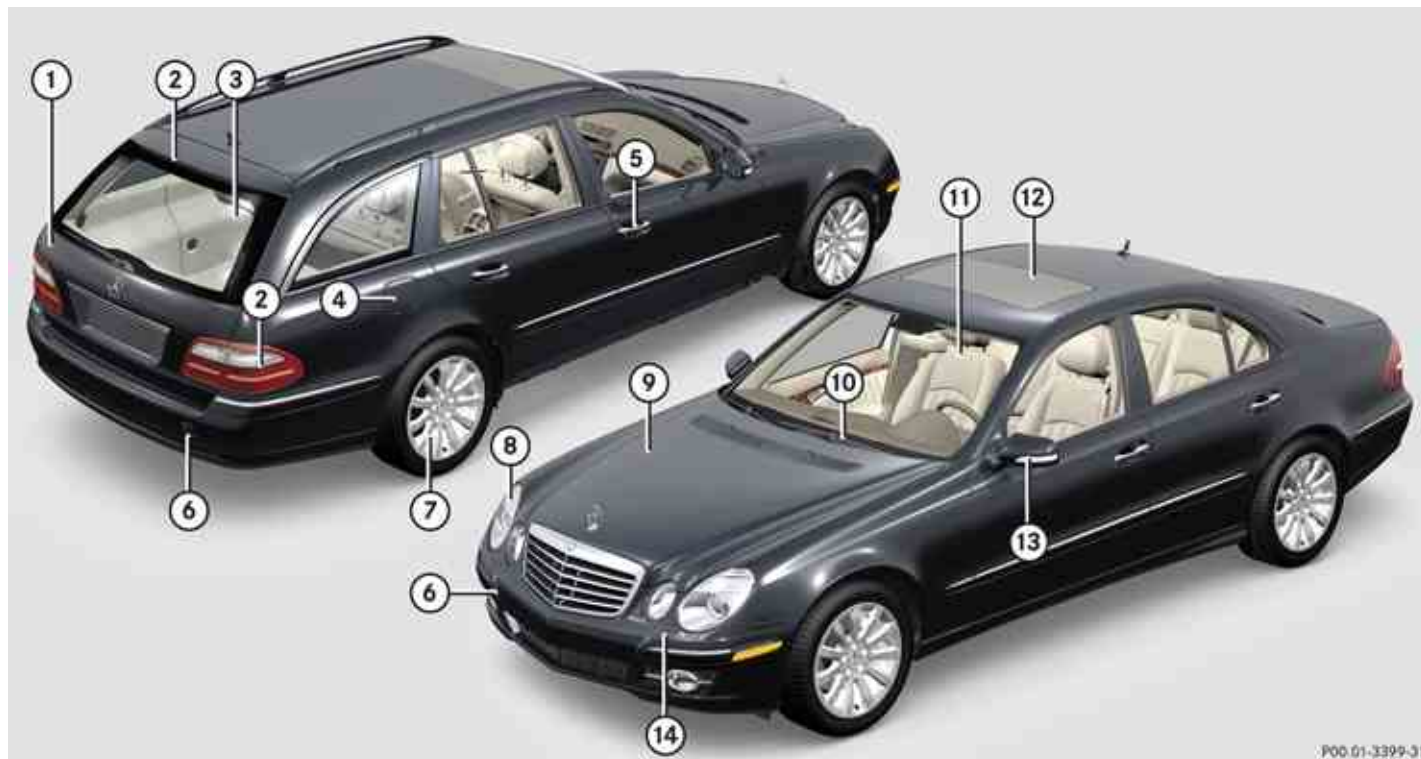

P00.01-3399-31

**i** This Operator's Manual describes all features, standard or optional, potentially available for your vehicle at the time of purchase. Please be aware that your vehicle might not be equipped with all features described in this manual.

	Function	Page
①	Trunk/tailgate:	
	Locking and unlocking	80
	Opening and closing	86, 89
	Valet locking	93
	Vehicle tool kit	290
②	Rear lamps	349
③	Rear window defroster	193
④	Fuel filler flap	240
	Fuel requirements	399
⑤	Doors:	
	Locking and unlocking	80
	Opening	84

	Function	Page
	Locking and unlocking manually	343, 344
⑥	Towing eye bolt	372
	General information	372
⑦	Tires and wheels	384
	Checking tire inflation pressure	255
	Spare wheel	293
	Flat tire	355
⑧	Front lamps	349
⑨	Hood	241
	Engine oil	243
	Coolant	245

	Function	Page
⑩	Wipers:	
	Wiper blades, replacing	352
	Wiper blades, cleaning	285
⑪	Windshield:	
	Cleaning with washer fluid	119
	Cleaning	285
⑫	Roof:	
	Power tilt/sliding sunroof	194
	Panorama roof with power tilt/sliding panel (sedan)	197
⑬	Exterior rear view mirrors	107
	Parking position	109
⑭	Headlamp cleaning system	114

## Cockpit

### Cockpit

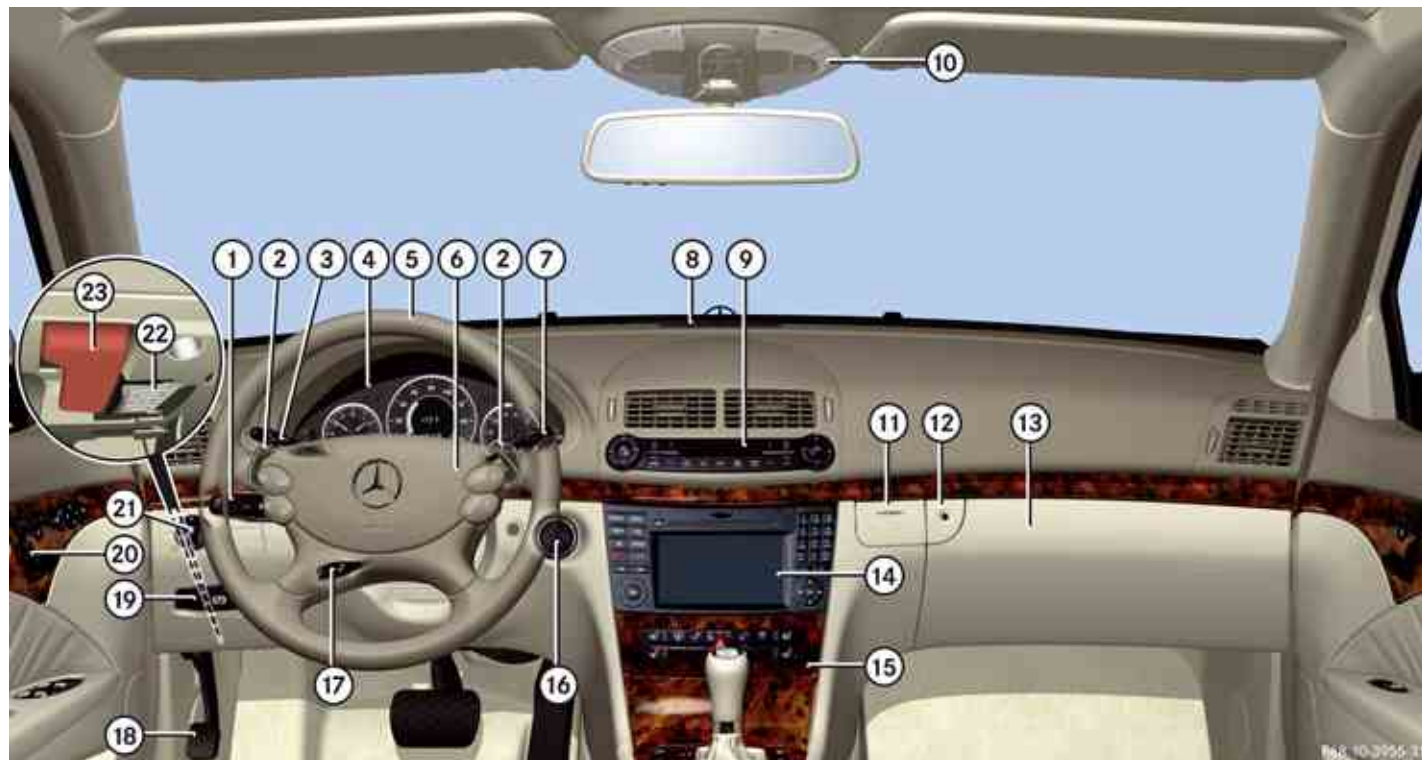

## Cockpit

	Function	Page
①	Combination switch:	
	Turn signals	114
	Wipers	118
	High beam	113
②	Steering wheel gearshift control (sedan)	134
	Steering wheel gearshift control (E 63 AMG only), (wagon)	134
③	Cruise control lever:	
	Cruise control	161
	Distronic (E 63 AMG only)	166
④	Instrument cluster	30
⑤	Multifunction steering wheel	35, 140
⑥	Horn	

	Function	Page
⑦	Lever for Voice Control System, see separate operating instructions	
⑧	Front Parktronic warning indicator (sedan)	176
⑨	Dual-zone automatic climate control	180
	4-zone automatic climate control	182
⑩	Overhead control panel	40
⑪	Mobile phone/Glasses box	217
⑫	Glove box lid release, glove box lock	217
⑬	Glove box	217

	Function	Page
⑭	COMAND system, see separate operating instructions	
⑮	Center console	37
⑯	Starter switch	94
⑰	Steering wheel adjustment stalk	105
	Heated steering wheel (Canada only)	106
⑱	Parking brake pedal	128
⑲	Parking brake release	128
⑳	Door control panel	41
㉑	Exterior lamp switch	111
㉒	On-board diagnostics (OBD) socket	
㉓	Hood lock release	241

## Instrument cluster







### Instrument cluster













P54.30-9473-31



## Instrument cluster

	Function	Page
①	 Left turn signal indicator lamp	
②	 ESP® warning lamp	335
③	<b>Speedometer</b>	
④	<b>Multifunction display</b>	141
⑤	 Distance warning lamp <sup>2</sup>	336
⑥	 Right turn signal indicator lamp	
⑦	<b>Coolant temperature indicator with:</b>	138
	 Coolant temperature warning lamp	339
⑧	<b>Tachometer with:</b>	
	 Supplemental Restraint System (SRS) indicator lamp	334

	Function	Page
	 Antilock Brake System (ABS) indicator lamp	331
	 Seat belt telltale	333
	 Low-beam headlamp indicator lamp	111
	 High-beam headlamp indicator lamp	113
⑨	<b>Main odometer with:</b>	
	Gear selector lever position	124
	Program mode	133
⑩	<b>Clock with:</b>	152
	 Brake warning lamp, USA only	331
	 Brake warning lamp, Canada only	332

	Function	Page
	 Engine malfunction indicator lamp, USA only	338
	 Engine malfunction indicator lamp, Canada only	338
	 Low tire pressure/TPMS malfunction telltale	257, 340
	 Preglow indicator lamp, diesel engine only	125
⑪	<b>Fuel display with:</b>	
	 Fuel tank reserve warning lamp	337
⑫	<b>Reset button for:</b>	
	Resetting trip odometer	139
	Adjusting instrument cluster illumination	138
	Confirming new time settings	152

<sup>2</sup> Vehicles without DISTRONIC: Warning lamp without function. It illuminates when the ignition is on. It should go out when the engine is running.

## Storage compartments

### Storage compartments

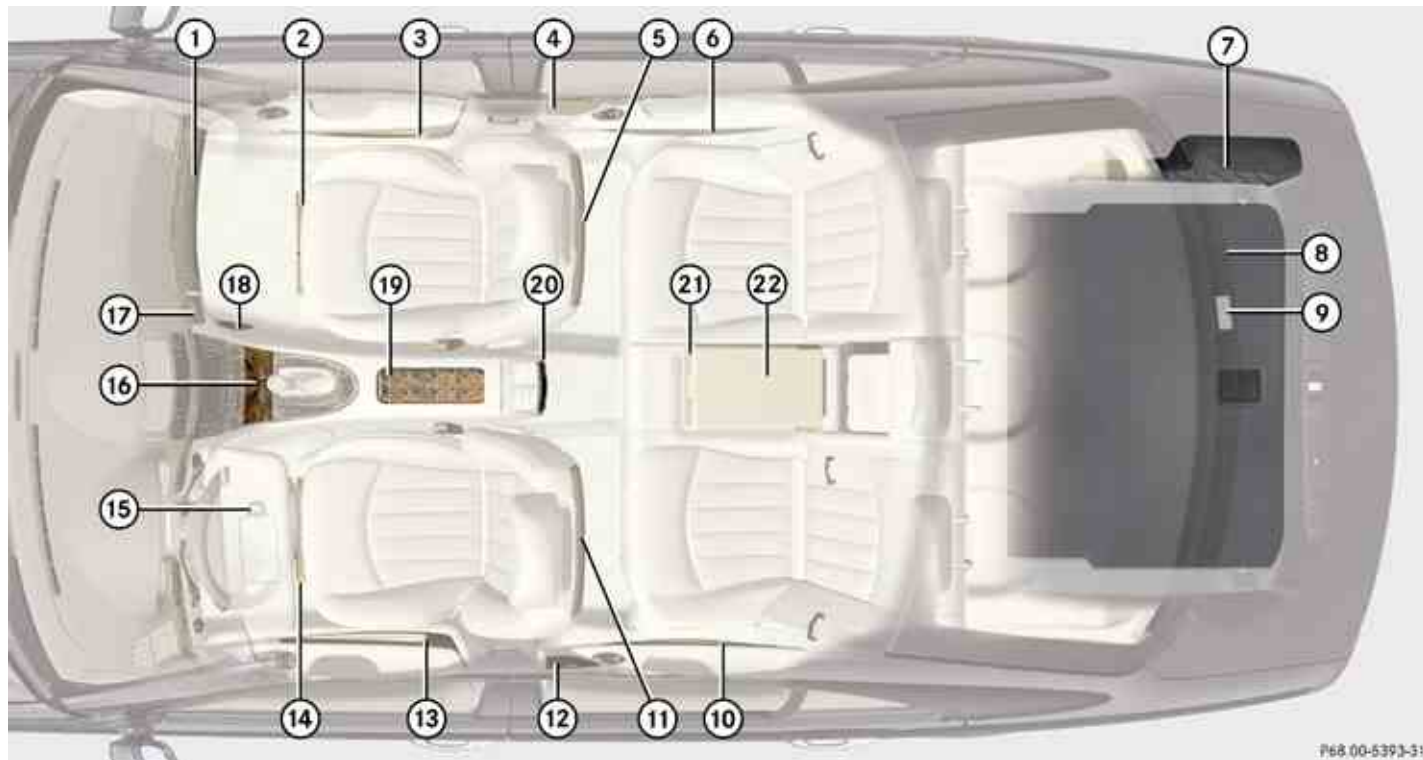

P68.00-5393-31

## Storage compartments

	Function	Page
①	Glove box	217
②	Front passenger seat storage compartment with first aid kit	290
③	Door pocket	
④	Ashtray	223
⑤	Storage bag	218
⑥	Door pocket	
⑦	Storage compartment	
⑧	Luggage box under the trunk floor (sedan)	294
⑨	Hook (sedan)	204
⑩	Door pocket	
⑪	Storage bag	218
⑫	Ashtray	223
⑬	Door pocket	
⑭	Driver's seat storage compartment	
⑮	Sun visor card clip	

	Function	Page
⑯	Ashtray with cigarette lighter	222
⑰	Mobile phone/Glasses box	217
⑱	Parcel net in front passenger footwell	203
⑲	Storage compartment with cup holders	219
⑳	Rear storage compartment in the rear center console	218
㉑	Cup holder in the rear armrest	220
㉒	Storage compartment in the rear armrest	218



## Storage compartments







	Function	Page
①	Storage box (Canada only)	212
②	Storage compartment	
③	Folding box (E 63 AMG)	216
④	Storage compartment	

## Multifunction steering wheel



	Function	Page
①	Multifunction display	141
②	Press button <b>+</b> or <b>-</b> <ul style="list-style-type: none"> <li>to select submenus in the Settings menu</li> <li>to set values</li> <li>to operate the RACETIMER<sup>3</sup></li> <li>to set the volume</li> </ul>	150    145
③	Press button  <ul style="list-style-type: none"> <li>to take a call</li> <li>to dial<sup>4</sup></li> <li>to redial<sup>4</sup></li> </ul> Press button  <ul style="list-style-type: none"> <li>to end a call</li> <li>to reject an incoming call</li> </ul>	    158 158 158  158 158



## Multifunction steering wheel

	Function	Page
④	Press button  or  to select next/previous menu	139
⑤	Press button  or  briefly <ul style="list-style-type: none"> <li>to move within a menu</li> <li>to select previous or next track, scene or stored station within <b>Audio/DVD</b> menu</li> <li>to switch to the phone book and select a name or number within <b>Telephone</b> menu</li> </ul>	   146  158

<sup>3</sup> AMG vehicles only.

<sup>4</sup> Function only available in telephone menu.

## Multifunction steering wheel

	Function	Page
	Press and hold button  or  <ul style="list-style-type: none"> <li>to select previous or next track with quick</li> </ul>	146

	Function	Page
	search or to select previous or next station in station list or wave	

	Function	Page
	band within <b>Audio/DVD</b> menu <ul style="list-style-type: none"> <li>to start the quick search in the phone book within <b>Telephone</b> menu</li> </ul>	158

Center console

Upper part

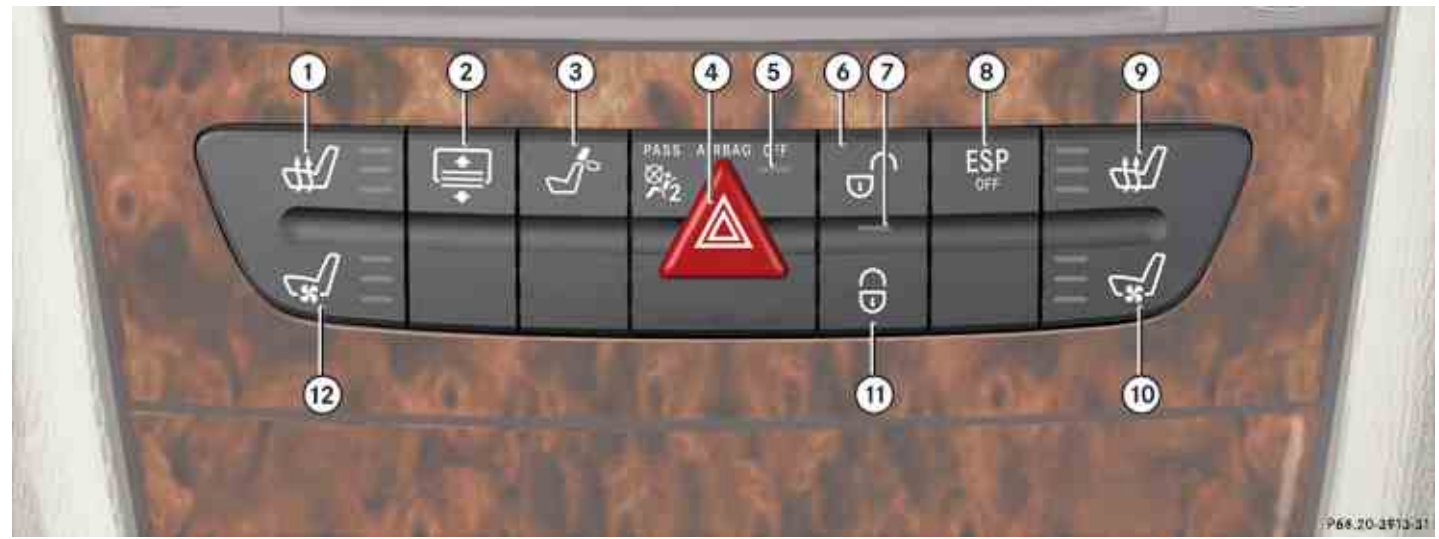

## Center console

	Function	Page
①	Seat heating, driver's side	102
②	Rear window sunshade switch (sedan)	222
③	Rear seat head restraints switch, folding down (sedan)	98
④	Hazard warning flasher switch	114
⑤	Front passenger front air bag off indicator lamp	53
⑥	Central unlocking switch	85
⑦	Alarm system indicator lamp	76
⑧	Electronic Stability Program (ESP®) control switch	74
⑨	Seat heating, front passenger side	102
⑩	Seat ventilation, front passenger side	101

	Function	Page
⑪	Central locking switch	85
⑫	Seat ventilation, driver's side	101



## Lower part



	Function	Page
①	Ashtray	222
②	KEYLESS-GO start/stop button	94
③	Gear selector lever for automatic transmission	130
④	Parking assist (Parktronic system) deactivation switch (sedan)	177
⑤	Adaptive Damping System (ADS) switch <sup>5</sup>	171
⑥	Vehicle level control switch <sup>5</sup>	172
⑦	Thumbwheel for setting distance for Distronic <sup>6</sup>	168
⑧	Distance warning function on/off switch <sup>6</sup>	171
⑨	Program mode selector switch for automatic transmission	133

<sup>5</sup> Only available on E 550, E 550 4MATIC and E 63 AMG.

<sup>6</sup> Only available on E 63 AMG.

## Overhead control panel

### Overhead control panel

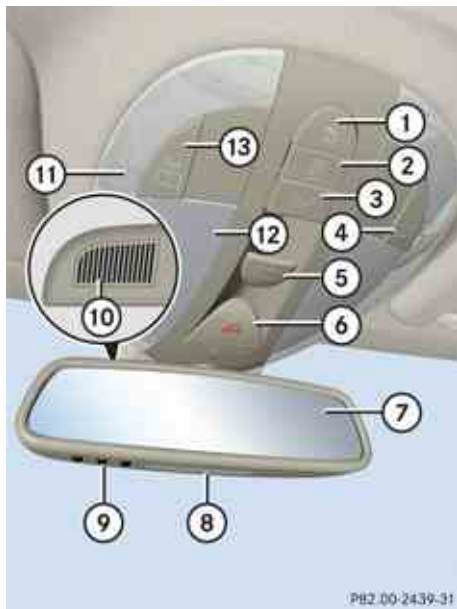

PB2.00-2439-31

	Function	Page
①	Rear interior lighting on/off	116
②	Automatic interior lighting	116
③	Front interior lighting on/off	116
④	Right reading lamp on/off	116
⑤	Tilt/sliding sunroof or tilt/sliding panel switch (sedan)	194 197
⑥	Tele Aid (emergency call system) button	226
⑦	Rear view mirror	107
⑧	Front reading lamps	116
⑨	Garage door opener	231
⑩	Hands-free microphone for Tele Aid (emergency call system), telephone, and Voice Control System, see separate operating instructions	
⑪	Ambient lighting	154

	Function	Page
⑫	Interior lighting	116
⑬	Left front reading lamp on/off	116

## Door control panel



	Function	Page
①	Inside door handle	84
②	Seat adjustment	97
③	Memory function (for storing seat, exterior mirror and steering wheel settings)	109
④	Exterior rear view mirror adjustment	107
⑤	Switches for opening/closing front and rear side windows, rear window override switch	120
⑥	Remote trunk release switch, trunk opening/closing system (sedan)	87
	Remote tailgate release switch, tailgate opening system (wagon)	87



<b>Vehicle equipment .....</b>	<b>44</b>
<b>Occupant safety .....</b>	<b>44</b>
<b>Panic alarm .....</b>	<b>70</b>
<b>Driving safety systems .....</b>	<b>70</b>
<b>Anti-theft systems .....</b>	<b>76</b>



## Occupant safety

### Vehicle equipment

**i** This Operator's Manual describes all features, standard or optional, potentially available for your vehicle at the time of purchase. Please be aware that your vehicle might not be equipped with all features described in this manual.

### Occupant safety

#### Introduction

In this section you will learn the most important facts about the restraint system components of the vehicle.

The restraint systems are

- Seat belts
- Child restraints
- Lower Anchors and Tethers for Children (LATCH)

Additional protection potential is provided by:

- Supplemental Restraint System (SRS) with
  - Air bags
  - Air bag control unit (with crash sensors)
  - Emergency Tensioning Device (ETD) for seat belts
  - Seat belt force limiter
- Active head restraints
- Preventive occupant safety (PRE-SAFE®)
- Air bag system components with

- Front passenger front air bag off indicator lamp
- Front passenger seat with Occupant Classification System (OCS)

Although the systems are independent, their protective functions work in conjunction with each other.

#### **Warning!**

Modifications to or work improperly conducted on restraint system components or their wiring, as well as tampering with interconnected electronic systems, can lead to the restraint systems no longer functioning as intended.

Air bags or Emergency Tensioning Devices (ETDs), for example, could deploy inadvertently or fail to deploy in accidents although the deceleration threshold for air bag deployment is exceeded. Therefore, never modify the restraint systems. Do not tamper with electronic components or their software.

**i** For information on infants and children traveling with you in the vehicle and restraint systems for infants and children,

see “Children in the vehicle” (▷ page 62).

### SRS indicator lamp

The SRS system conducts a self-test when the ignition is switched on and in regular intervals while the engine is running. This facilitates detection of system malfunctions.

The **SRS** indicator lamp in the instrument cluster comes on when the ignition is switched on and goes out no later than a few seconds after the engine has been started.

The SRS components are in operational readiness if the **SRS** indicator lamp is not lit when the engine is running.

A malfunction in the system has been detected if the **SRS** indicator lamp

- fails to go out after approximately 4 seconds after the engine is started
- does not come on at all
- comes on after the engine was started or while driving

#### **Warning!**

In the event that the **SRS** indicator lamp comes on while driving or does not come on at all, the SRS self-check has detected

a malfunction. For your safety, we strongly recommend that you contact an authorized Mercedes-Benz Center immediately to have the system checked; otherwise the SRS may not deploy when needed in an accident, which could result in serious or fatal injury, or it might deploy unexpectedly and unnecessarily which could also result in injury.

In addition, improper work on the SRS creates a risk of rendering the SRS inoperative or causing unintended air bag deployment. Work on the SRS must therefore only be performed by qualified technicians. Contact an authorized Mercedes-Benz Center.

If it is necessary to modify an air bag system to accommodate a person with disabilities, contact an authorized Mercedes-Benz Center or call our Customer Assistance Center at 1-800-FOR-MERcedes (1-800-367-6372) for details.

### Air bags

#### **Warning!**

Air bags are designed to reduce the potential of injury and fatality in certain frontal impacts (front air bags), side impacts (side impact air bags and window curtain air bags), or rollovers (window curtain air bags). However, no system available today can completely eliminate injuries and fatalities.

The deployment of the air bags temporarily releases a small amount of dust from the air bags. This dust, however, is neither injurious to your health, nor does it indicate a fire in the vehicle. The dust might cause some temporary breathing difficulty for people with asthma or other breathing trouble. To avoid this, you may wish to get out of the vehicle as soon as it is safe to do so. If you have any breathing difficulty but cannot get out of the vehicle after the air bag inflates, then get fresh air by opening a window or door.

#### **Warning!**

To reduce the risk of injury when the front air bags inflate, it is very important for the driver and front passenger to always be in

### Occupant safety

a properly seated position and to wear their respective seat belt.

For maximum protection in the event of a collision always be in normal seated position with your back against the seat backrest. Fasten your seat belt and make sure it is properly positioned on your body. Since the air bag inflates with considerable speed and force, a proper seating position and correct positioning of the hands on the steering wheel will help to keep you at a safe distance from the air bag. Occupants who are not wearing their seat belt, are not seated properly or are too close to the air bag can be seriously injured or killed by an air bag as it inflates with great force instantaneously:

- Sit with the seat belt properly fastened in a position that is as upright as possible with your back against the seat backrest.
- Move the driver seat as far back as possible, still permitting proper operation of vehicle controls. The distance from the center of the driver's chest to the center of the air bag cover on the steering wheel must be at least 10 inches (25 cm) or more. You should be able to accomplish this by adjusting

the seat and steering wheel. If you have any difficulties, please contact an authorized Mercedes-Benz Center.

- Do not lean your head or chest close to the steering wheel or dashboard.
- Keep hands on the outside of the steering wheel rim. Placing hands and arms inside the rim can increase the risk and potential severity of hand/arm injury when the driver front air bag inflates.
- Adjust the front passenger seat as far as possible rearward from the dashboard when the seat is occupied.
- Occupants, especially children, should never place their bodies or lean their heads in the area of the door where the side impact air bag inflates. This could result in serious injuries or death should the side impact air bag be deployed. Always sit as upright as possible, wear the seat belt properly and use an appropriately sized infant restraint, toddler restraint, or booster seat recommended for the size and weight of the child.

Failure to follow these instructions can result in severe injuries to you or other occupants.

If you sell your vehicle, it is important that you make the buyer aware of this safety information. Be sure to give the buyer this Operator's Manual.

#### **Warning!**

Accident research shows that the safest place for children in an automobile is in the rear seat.

There is a possibility for a side impact air bag-related injury if occupants, especially children, are not properly seated or restrained when next to a side impact air bag which needs to deploy rapidly in a side impact in order to do its job.

To help avoid the possibility of injury, please follow these guidelines:

- (1) Occupants, especially children, should never place their bodies or lean their heads in the area of the door where the side impact air bags inflates. This could result in serious injuries or death



should the side impact air bags be deployed.

- (2) Always sit as upright as possible, properly use the seat belts, and for children 12 years old and under, use an appropriately sized infant restraint, toddler restraint, or booster seat recommended for the size and weight of the child.
- (3) Always wear seat belts properly.

If you believe that, even with the use of these guidelines, it would be safer for your rear seat occupants to have the rear mounted side impact air bags deactivated, then deactivation can be carried out upon your written request at an authorized Mercedes-Benz Center at an additional cost.

Please contact an local authorized Mercedes-Benz Center or call the Customer Assistance Center (in the USA) at 1-800-FOR-MERcedes (1-800-367-6372), or Customer Service (in Canada) at 1-800-387-0100 for details.

Air bags are designed to deploy only in certain frontal impacts (front air bags), side impacts (side impact and window curtain air bags)

which exceed preset deployment thresholds, and in certain rollovers (window curtain air bags). Only in the event of such a situation will they provide their supplemental protection.

The driver and passengers should always wear their seat belts. Otherwise it is not possible for the air bags to provide their supplemental protection.

In case of other types of impacts and impacts below air bag deployment thresholds, air bags will not deploy. The driver and passengers will then be protected to the extent possible by a properly fastened seat belt. A properly fastened seat belt is also needed to provide the best possible protection in a rollover.

Air bags are not a substitute for seat belts. Always wear your seat belt, regardless of whether or not your vehicle is equipped with air bags.

It is important to your safety and that of your passengers that you replace deployed air bags and repair any malfunctioning air bags to make sure the vehicle will continue to provide supplemental crash protection for occupants.

### Safety guidelines for the seat belt, Emergency Tensioning Device (ETD) and air bag

#### **Warning!**

- Damaged seat belts or seat belts that have been subjected to stress in an accident must be replaced and their anchoring points must also be checked. Only use seat belts installed or supplied by an authorized Mercedes-Benz Center.
- Air bags and pyrotechnic Emergency Tensioning Devices (ETDs) contain perchlorate material, which may require special handling and regard for the environment. Check with your local government's disposal guidelines. California residents, see [www.dtsc.ca.gov/HazardousWaste/Perchlorate/index.cfm](http://www.dtsc.ca.gov/HazardousWaste/Perchlorate/index.cfm).
- Air bags and ETDs are designed to function on a one-time-only basis. An air bag or ETD that is deployed must be replaced.
- Do not pass seat belts over sharp edges. They could tear.

### Occupant safety

- Do not make any modification that could change the effectiveness of the seat belts.
- Do not bleach or dye seat belts as this may severely weaken them. In a crash they may not be able to provide adequate protection.
- No modifications of any kind may be made to any components or wiring of the SRS. This includes changing or removing any component or part of the SRS, the installation of additional trim material, seat covers, badges, etc. over the steering wheel hub, front passenger front air bag cover, outboard sides of the seat backrests, door trim panels, or door frame trims, and installation of additional electrical/electronic equipment on or near SRS components and wiring. Keep area between air bags and occupants free of objects (e.g. packages, purses, umbrellas, etc.).
- Do not hang items such as coat hangers from the coat hooks or handles over the door. These items may be thrown around in the vehicle and cause head and other injuries when the window curtain air bag is deployed.
- Air bag system components will be hot after an air bag has inflated. Do not touch them.
- Never place your feet on the instrument panel, dashboard, or on the seat. Always keep both feet on the floor in front of the seat.
- In addition, improper repair work on the SRS creates a risk of rendering the SRS inoperative or causing unintended air bag deployment. Work on the SRS must therefore only be performed by qualified technicians. Contact an authorized Mercedes-Benz Center.
- For your protection and the protection of others, when scrapping the air bag unit or ETD, our safety instructions must be followed. These instructions are available from any authorized Mercedes-Benz Center.
- Given the considerable deployment speed, required inflation volume, and the material of the air bags, there is the possibility of abrasions or other, potentially more serious injuries resulting from air bag deployment.

If you sell your vehicle, we strongly recommend that you inform the subsequent

owner that the vehicle is equipped with SRS and refer them to the applicable section in the Operator's Manual.

### Front air bags

 **Observe Safety notes, see page 47.**



- ① Driver front air bag
- ② Front passenger front air bag

The front air bags are designed to provide increased protection for the driver and front passenger against the risk of injuries to the head and thorax.

Driver and front passenger front air bags are deployed

- in the event of certain frontal impacts
- if impact exceeds a preset deployment threshold
- if the system determines that air bag deployment can offer additional protection to that provided by the seat belt
- depending on whether the seat belt is in use
- independently of the side impact air bags and/or the window curtain air bags

The front air bags in this vehicle have been designed to inflate in two stages. This allows the air bags to have different rates of inflation that are based on the vehicle deceleration rate as assessed by the air bag control unit.

On the front passenger side, front air bag ② deployment is additionally influenced by the passenger's weight category as identified by the Occupant Classification System (OCS) (▷ page 50).

The lighter the front passenger side occupant, the higher the vehicle deceleration rate required for second stage inflation of front air bag ②.

The air bags will not deploy in impacts which do not exceed the system's preset deployment thresholds. You will then be protected by the fastened seat belts.

The front air bags will not deploy in the event of a rollover unless the vehicle's rate of longitudinal deceleration or acceleration exceeds the preset deployment threshold for the front air bags.

The front passenger front air bag ② will only be deployed if

- the system, based on OCS weight sensor readings, detects that the front passenger seat is occupied
- the **PASS AIR BAG OFF**  indicator lamp in the center console is not lit (▷ page 53)
- the impact exceeds a preset deployment threshold

## Side impact air bags

 **Observe Safety notes, see page 47.**



Example illustration sedan

- ① Front side impact air bag
- ② Rear side impact air bag

When deployed, the side impact air bags are designed to provide increased protection for the thorax (but not the head, neck and arms) of the occupants on the side of the vehicle on which the impact occurs.

The side impact air bags are deployed

- on the impacted side of the vehicle
- in side impacts exceeding a preset deployment threshold
- regardless of whether the seat belt is in use



### Occupant safety

- independently of the front air bags
- independently of the ETDs

The side impact air bags are not deployed in side impacts which do not exceed the system's deployment threshold.

The side air bags will not deploy in the event of a rollover unless the vehicle's rate of lateral deceleration or acceleration exceeds the preset deployment threshold for the side air bags.

#### **Warning!**

Only use seat covers which have been tested and approved by Mercedes-Benz for your vehicle model. Using other seat covers may interfere with or prevent the deployment of the front side impact air bags. Contact an authorized Mercedes-Benz Center for availability.

### Window curtain air bags

 **Observe Safety notes, see page 47.**



Example illustration sedan

① Window curtain air bag

When deployed, window curtain air bags ① are designed to provide increased protection for the head (but not the chest or arms) of the occupants on the side of the vehicle on which the impact occurs.

Window curtain air bags ① are deployed

- on the impacted side of the vehicle
- in side impacts exceeding a preset deployment threshold
- independently of the front air bags

- regardless of whether the front passenger seat is occupied
- in certain vehicle rollovers, if the system determines that air bag deployment can offer additional protection to that provided by the seat belt

Window curtain air bags ① are not deployed in impacts which do not exceed the system's deployment threshold.

Window curtain air bags ① deploy in the area indicated by the arrows.

### Occupant Classification System

The Occupant Classification System (OCS) automatically turns the front passenger front air bag on or off based on the classified occupant weight category determined by weight sensor readings from the front passenger seat.

The system does not deactivate the front passenger side impact air bag, the window curtain air bag and the Emergency Tensioning Devices (ETDs).

Occupants must sit with the seat belt properly fastened in a position that is as upright as possible with their back against the seat backrest and feet on the floor to be correctly classified. If the occupant's weight



## Occupant safety

is transferred to another object in the vehicle (e.g. by leaning on armrests), the OCS may not be able to properly approximate the occupant's weight category.

Furthermore, the occupant weight may appear to increase or decrease due to the following: objects hanging on the seat, lodged underneath the seat, stuffed between the seat and middle console or the seat and door, other passengers pushing on the seat, or objects applying pressure to the back of the seat. Always make sure the seat has clearance in all directions at all times.



**i** If your seat, including the trim cover and cushion, needs to be serviced in any way, take the vehicle to an authorized Mercedes-Benz Center.

Only seat accessories approved by Mercedes-Benz may be used.



Both the driver and the front passenger should always use the   indicator lamp as an indication of whether or not the front passenger is properly positioned.



### Warning!

If the   indicator lamp illuminates when an adult or someone







larger than a small individual is in the front passenger seat, have the front passenger re-position himself or herself in the seat until the   indicator lamp goes out, or check whether objects are caught under or around the seat.



In the event of a collision, the air bag control unit will not allow front passenger front air bag deployment when the OCS has classified the front passenger seat occupant as weighting as much as or less than a typical 12-month-old child in a standard child restraint or if the front passenger seat is classified as being empty.

When the OCS senses that the front passenger seat occupant is classified as being up to or less than the weight of a typical 12-month-old child in a standard child restraint, the   indicator lamp will illuminate when the engine is started and remain illuminated, indicating that the front passenger front air bag is deactivated.

When the OCS senses that the front passenger seat is classified as being empty, the   indicator lamp will illuminate when the engine is started and



remain illuminated, indicating that the front passenger front air bag is deactivated.



When the OCS senses that the front passenger seat occupant is classified as being heavier than the weight of a typical 12-month-old child seated in a standard child restraint or as being a small individual (such as a young teenager or a small adult), the   indicator lamp will illuminate for approximately 6 seconds when the engine is started and then, depending on occupant weight sensor readings from the seat, remain illuminated or go out. With the   indicator lamp illuminated, the front passenger front air bag is deactivated. With the   indicator lamp out, the front passenger front air bag is activated.

When the OCS senses that the front passenger seat occupant is classified as an adult or someone larger than a small individual, the   indicator lamp will illuminate for approximately 6 seconds when the engine is started and then go out, indicating that the front passenger front air bag is activated.



## Occupant safety

If the   indicator lamp is illuminated, the front passenger front air bag is deactivated and will not be deployed.

If the   indicator lamp is not illuminated, the front passenger front air bag is activated and will be deployed

- in the event of certain frontal impacts
- if impact exceeds a preset deployment threshold
- independently of the side impact air bags

If the front passenger front air bag is deployed, the rate of inflation will be influenced by

- the rate of relevant vehicle deceleration as assessed by the air bag control unit
- the front passenger's weight category as identified by the OCS

For more information on air bag display messages, see (▷ page 299).

### **Warning!**

According to accident statistics, children are safer when properly restrained in the rear seating positions than in the front seating position. Thus, we strongly recommend that children be placed in the

rear seats whenever possible. Regardless of seating position, children 12 years old and under must be seated and properly secured in an appropriate infant restraint, toddler restraint, or booster seat recommended for the size and weight of the child.

The infant or child restraint must be properly secured with the vehicle's seat belt, the seat belt and top tether strap, or lower anchors and top tether strap, fully in accordance with the child seat manufacturer's instructions.







Occupants, especially children, should always sit as upright as possible, wear the seat belt properly and use an appropriately sized infant restraint, toddler restraint, or booster seat recommended for the size and weight of the child.

Children can be killed or seriously injured by an inflating air bag. Note the following important information when circumstances require you to place a child in the front passenger seat:

- Your vehicle is equipped with air bag technology designed to deactivate the front passenger front air bag in your vehicle when the system senses the

weight of a typical 12-month-old child or less along with the weight of a standard appropriate child restraint on the front passenger seat.

- A child in a rear-facing child restraint on the front passenger seat will be seriously injured or even killed if the front passenger front air bag inflates in a collision which could occur under some circumstances, even with the air bag technology installed in your vehicle. The only means to completely eliminate this risk is to never place a child in a rear-facing child restraint in the front seat. We therefore strongly recommend that you always place a child in a rear-facing child restraint in a backseat.

- If you must install a rear-facing child restraint on the front passenger seat because circumstances require you to do so, make sure the   indicator lamp is illuminated, indicating that the front passenger front air bag is deactivated. Should the   indicator lamp not illuminate or go out while the restraint is installed, please check installation. Periodically check the   indicator lamp while

## Occupant safety

driving to make sure the

**PASS AIR BAG OFF**  indicator lamp is

illuminated. If the **PASS AIR BAG OFF**  indicator lamp goes out or remains out,

do not transport a child on the front passenger seat until the system has been repaired.

A child in a rear-facing child restraint on the front passenger seat will be seriously injured or even killed if the front passenger front air bag inflates.

- If you have to place a child in a forward-facing child restraint on the front passenger seat, move the seat as far back as possible, use the proper child restraint recommended for the age, size and weight of the child, and secure child restraint with the vehicle's seat belt according to the child seat manufacturer's instructions. For children larger than the typical 12-month-old child, the front passenger front air bag may or may not be activated.

Deployment of the driver front air bag does not mean that the front passenger front air bag also should have deployed.

The OCS may have determined:

- that the seat was empty or occupied by the weight up to or less than that of a typical 12-month-old child seated in a standard child restraint – both instances where the system suppresses deployment of the front passenger front air bag even though the impact met the criteria and was of sufficient severity to deploy the driver front air bag
- that the seat was occupied by a small individual (such as a young teenager or a small adult) or a child who weighs more than the weight of a typical 12-month-old child in a standard child restraint – both of which are instances where the system may suppress deployment of the front passenger front air bag even though the impact met the criteria and was of sufficient severity to deploy the driver front air bag



① Front passenger front air bag off indicator lamp

The **PASS AIR BAG OFF**  indicator lamp ① will be illuminated, except with the SmartKey removed from the starter switch or with the starter switch in position **0**.

### **Warning!**

If the **SRS** indicator lamp and the **PASS AIR BAG OFF**  indicator lamp are lit at the same time, there is a malfunction in the OCS. The front passenger front air bag will be deactivated in this case. Have the system checked as soon as possible by qualified technicians. Contact an authorized Mercedes-Benz Center. Only have the seat repaired or replaced at an authorized Mercedes-Benz Center.





## Occupant safety





In order to ensure proper operation of the air bag system and OCS:



- Do not place more than 4.4 lb (2 kg) into the storage bag on the back of the front passenger seat. Otherwise, the OCS may not be able to properly approximate the occupant weight category.
- Do not place objects under and/or around the front passenger seat.
- Do not hang anything from or attach any items to the seats.
- Do not stuff objects such as books between the front passenger seat and the center console or front passenger door.
- Do not move the front passenger seat backwards against stiff objects.
- Sit with the seat belt properly fastened in a position that is as upright as possible with your back against the seat backrest.
- While seated, an occupant should not position him/herself in such a way as to cause the occupant's weight to be lifted from the seat bottom as this may result in the OCS being unable to correctly

approximate the occupant's weight category.



- Read and observe all warnings in this chapter.

### Occupant Classification System Self-test

After turning the SmartKey in the starter switch to position **1** or **2** or pressing the KEYLESS-GO start/stop button once or twice, the   indicator lamp illuminates. If an adult occupant is properly sitting on the front passenger seat and the system classifies the occupant as an adult, the   indicator lamp will illuminate and go out after approximately 6 seconds.

If the seat is not occupied and the system classifies the front passenger seat as being empty, the   indicator lamp will illuminate and not go out.

#### **Warning!**

If the   indicator lamp does not illuminate, the system is not functioning. You must contact an authorized Mercedes-Benz Center before

seating any child on the front passenger seat.

For more information, see the “Practical hints” section (▷ page 341).

#### **Warning!**

Never place anything between seat cushion and child seat (e.g. pillow), since it reduces the effectiveness of the OCS. The bottom and back of the child seat must make full contact with the passenger seat cushion and backrest.

If necessary, adjust the tilt of the passenger seat backrest.

An incorrectly mounted child seat could cause injuries to the child in case of an accident, instead of increasing protection for the child.

Follow the manufacturer's instructions for installation of child seats.



## Seat belts

### Safety notes

The use of seat belts and infant and child restraint systems is required by law in all 50 states, the District of Columbia, the U.S. territories and all Canadian provinces.

Even where this is not the case, all vehicle occupants should have their seat belts fastened whenever the vehicle is in motion.

For information on infants and children traveling with you in the vehicle and restraint systems for infants and children, see “Children in the vehicle” (▷ page 62).

#### **Warning!**

Always fasten your seat belt before driving off. Always make sure all of your passengers are properly restrained. You and your passengers should always wear seat belts.

Failure to wear and properly fasten and position your seat belt greatly increases your risk of injuries and their likely severity in an accident.

If you are ever in an accident, your injuries can be considerably more severe without your seat belt properly buckled. Without your seat belt buckled, you are much more

likely to hit the interior of the vehicle or be ejected from it. You can be seriously injured or killed.

In the same crash, the possibility of injury or death is lessened if you are properly wearing your seat belt. The air bags can only protect as intended if the occupants are properly wearing their seat belts.

#### **Warning!**

Never ride in a moving vehicle with the seat backrest in an excessively reclined position as this can be dangerous. You could slide under the seat belt in a collision. If you slide under it, the seat belt would apply force at the abdomen or neck. That could cause serious or even fatal injuries. The seat backrest and seat belt provide the best restraint when the wearer is in a position that is as upright as possible and the seat belt is properly positioned on the body.

#### **Warning!**

Never let more people ride in the vehicle than there are seat belts available. Make sure everyone riding in the vehicle is correctly restrained with a separate seat belt. Never use a seat belt for more than one person at a time.

#### **Warning!**

Damaged seat belts or seat belts that have been subjected to stress in an accident must be replaced and their anchoring points must also be checked.

Only use seat belts which have been approved by Mercedes-Benz.

Do not make any modifications to the seat belts. This can lead to unintended activation of the ETDs or to their failure to activate when necessary.

Do not bleach or dye seat belts as this may severely weaken them. In a crash they may not be able to provide adequate protection.

Have all work carried out only by qualified technicians. Contact an authorized Mercedes-Benz Center.

### Proper use of seat belts

#### **Warning!**

#### USE SEAT BELTS PROPERLY

- Seat belts can only work when used properly. Never wear seat belts in any other way than as described in this

### Occupant safety

section, as that could result in serious injuries in case of an accident.

- Each occupant should wear their seat belt at all times, because seat belts help reduce the likelihood of and potential severity of injuries in accidents, including rollovers. The integrated restraint system includes SRS (driver front air bag, front passenger front air bag, side impact air bags, window curtain air bags for side windows), Emergency Tensioning Devices (ETDs), seat belt force limiters, and front seat knee bolsters.

The system is designed to enhance the protection offered to properly belted occupants in certain frontal (front air bags and ETDs) and side (side impact air bags, window curtain air bags, and ETDs) impacts which exceed preset deployment thresholds and in certain rollovers (window curtain air bags and ETDs).

- Never wear the shoulder belt under your arm, against your neck or off your shoulder. In a frontal crash, your body would move too far forward. That would increase the chance of head and neck injuries. The seat belt would also apply

too much force to the ribs or abdomen, which could severely injure internal organs such as your liver or spleen.

Adjust the seat belt so that the shoulder section is located as close as possible to the middle of the shoulder (it should not touch the neck). Never pass the shoulder portion of the seat belt under your arm. For this purpose, you can adjust the height of the seat belt outlet.

- Position the lap belt as low as possible on your hips and not across the abdomen. If the lap belt is positioned across your abdomen, it could cause serious injuries in a crash.
- Never wear seat belts over rigid or breakable objects in or on your clothing, such as eyeglasses, pens, keys etc., as these might cause injuries.
- Make sure the seat belt is always fitted snugly. Take special care of this when wearing loose clothing.
- Never use a seat belt for more than one person at a time. Do not fasten a seat belt around a person and another person or other objects at the same time.

- Seat belts should not be worn twisted. In a crash, you would not have the full width of the seat belt to distribute impact forces. The twisted seat belt against your body could cause injuries.

- Pregnant women should also always use a lap/shoulder belt. The lap belt portion should be positioned as low as possible on the hips to avoid any possible pressure on the abdomen.

- Place the seat backrest in a position that is as upright as possible.

- Check your seat belt during travel to make sure it is properly positioned.

- Never place your feet on the instrument panel, dashboard, or on the seat. Always keep both feet on the floor in front of the seat.

- When using a seat belt to secure infant restraints, toddler restraints, or children in booster seats, always follow the child seat manufacturer's instructions.

#### **Warning!**

Do not pass seat belts over sharp edges. They could tear.

## Occupant safety

Do not allow the seat belt to get caught in the door or in the seat adjustment mechanism. This could damage the seat belt.

Never attempt to make modifications to seat belts. This could impair the effectiveness of the seat belts.

### Fastening the seat belts

#### **Warning!**

According to accident statistics, children are safer when properly restrained in the rear seating positions than in the front seating position. Thus, we strongly recommend that children be placed in the rear seats whenever possible. Regardless of seating position, children 12 years old and under must be seated and properly secured in an appropriately sized infant restraint, toddler restraint, or booster seat recommended for the size and weight of the child. For additional information, see “Children in the vehicle”.

A child’s risk of serious or fatal injuries is significantly increased if the child restraints are not properly secured in the vehicle and/or the child is not properly secured in the child restraint.



- ① Seat belt outlet
- ② Latch plate
- ③ Buckle
- ④ Seat belt release button

- ▶ With a smooth motion, pull the seat belt out of seat belt outlet ①.
- ▶ Place the shoulder portion of the seat belt across the top of your shoulder and the lap portion across your hips.

- ▶ Push latch plate ② into buckle ③ until it clicks.
- ▶ If necessary, adjust the seat belt to the correct height.
- ▶ If necessary, tighten the lap portion to a snug fit by pulling shoulder portion up.

### Seat belt outlet height adjustment



- ① Seat belt height adjuster
- ② Release button

- ▶ **Raising:** Slide seat belt height adjuster ① upward. Seat belt height adjuster ① engages in different positions.

### Occupant safety

- ▶ **Lowering:** Press and hold release button ②.
- ▶ Slide seat belt height adjuster ① downward.
- ▶ Release button ② and make sure seat belt height adjuster ① engages into place.

### Releasing the seat belts



- ▶ Press seat belt release button ④ (▷ page 57).  
Allow the retractor to completely rewind the seat belt by guiding latch plate ② (▷ page 57).
- ❗ Make sure the seat belt retracts fully so that the seat belt and/or latch plate cannot get caught or pinched in the door or in the seat mechanism. This can damage the seat belt and impair its effectiveness, and/or cause damage to the door and/or door trim panel. Such damage is not covered by the Mercedes-Benz Limited Warranty.  
Damaged seat belts must be replaced. Contact an authorized Mercedes-Benz Center.

### Enhanced seat belt reminder system

When the engine is started, the seat belt telltale  will always illuminate for 6 seconds to remind you and your passengers to fasten your seat belts.

If the driver's seat belt is not fastened when the engine is started, an additional warning chime will also sound for a maximum of 6 seconds or until the driver's seat belt is fastened.

If after these 6 seconds the driver's or the front passenger's seat belt (with the front passenger seat occupied) is not fastened with front doors closed,

- the seat belt telltale  remains illuminated for as long as either the driver's or front passenger's seat belt is not fastened.
- and if the vehicle speed once exceeds 15 mph (25 km/h), the seat belt telltale  starts flashing and a warning chime sounds with increasing intensity for a maximum of 60 seconds or until the driver's and front passenger's seat belt are fastened.

If you and/or your passenger release the seat belt during driving, the seat belt

telltale  starts flashing and the warning chime sounds as described before.

If the driver's or the front passenger's seat belt remains unfastened after 60 seconds, the warning chime stops sounding, the seat belt telltale  stops flashing but continues to be illuminated.

After a vehicle standstill, the warning chime is reactivated and the seat belt telltale  is flashing again if the vehicle speed once exceeds 15 mph (25 km/h).

The seat belt telltale  will only go out if both the driver's and the front passenger's seat belt (with the front passenger seat occupied) are fastened, or the vehicle is standing still and a front door is opened. For more information, see "Practical hints" (▷ page 333).

### Emergency Tensioning Device (ETD), seat belt force limiter

The seat belts for the front seats and rear outer seats (sedan) or front seats and second row outer seats (wagon) are equipped with ETDs and seat belt force limiters.

The ETDs are designed to activate in the following cases:

- in frontal or rear-end impacts exceeding the system's preset deployment threshold
- in side impacts exceeding the system's preset deployment threshold on the far side of the impact
- in certain vehicle rollovers
- if the restraint systems are operational and functioning correctly, see **SRS** indicator lamp (▷ page 45)

The ETDs for the front seats will only activate if the front seat belts are fastened (latch plate properly inserted into buckle).

The ETDs for the rear outer seats (sedan) or second row outer seats (wagon) will activate with or without the respective seat belts fastened.

In an impact, the ETDs remove slack from the seat belts in such a way that the seat belts fit more snugly against the body. Seat belt force limiters, when activated, are employed to help reduce the peak force exerted by the seat belts on occupants during a crash.

- ❗ The ETDs do not correct an incorrect seat position or incorrectly worn seat belts.

The ETDs do not pull occupants back toward the seat backrest.

### **Warning!**

Pyrotechnic ETDs that were activated must be replaced.

For your safety, when disposing of the pyrotechnic ETDs always follow our safety instructions. These are available at any authorized Mercedes-Benz Center.

### **Automatic comfort-fit feature seat belt**

An automatic comfort-fit feature for the front seats reduces the retracting force of the seat belts when they are in normal use.

### **Preventive occupant safety (PRE-SAFE®)**

#### **Warning!**

PRE-SAFE® is intended to reduce the effects of an accident on vehicle occupants who are wearing their seat belt properly. Despite having the PRE-SAFE® system in your vehicle, the possibility of injuries occurring as a result of an accident cannot be eliminated. Therefore, you should always drive carefully and adjust your

driving to the prevailing road, weather, and traffic conditions.

Your vehicle takes preventive measures to better protect the occupants in the following hazardous situations automatically.

PRE-SAFE® takes preventive measures in

- emergency braking situations, e.g. if the Brake Assist System (BAS) (▷ page 72) is activated
- critical dynamic driving situations, e.g. when the vehicle is understeering or oversteering because it has exceeded its physical limitations or in case of evasive steering maneuvers at speeds above approximately 85 mph (140 km/h)

When you are driving faster than 20 mph (30 km/h), PRE-SAFE® takes the following measures in such situations:

- The front seat belts are pre-tensioned automatically.
- If the passenger seat is in an unfavorable position, it will be adjusted to a better position.
- If the vehicle is in a critical dynamic driving situation, the door windows and the tilt/sliding sunroof also closes until only a small gap remains.



### Occupant safety

If the closing procedure of the door windows or tilt/sliding sunroof is blocked, the door windows or tilt/sliding sunroof will stop and open slightly.

Once the hazardous situation is over without an accident occurring, the seat belt pre-tensioning is deactivated. You can readjust all of the settings made by PRE-SAFE®.

If the seat belts do not release:

- ▶ Adjust the seat backrest or seat slightly to the rear until the seat belt tension is diminished.

The locking mechanism releases.

- ❗ When moving the seats, make sure there are no items in the footwell or behind the seats. Otherwise, you could damage the seats.

#### Active head restraints

The active head restraints are intended to offer the driver and front passenger increased protection from whiplash-type injuries. In the event of a rear-end collision, the active head restraints on the driver's and front passenger's seat are designed to move forward in the direction of travel, providing the head with increased support earlier on in the collision sequence. The active head restraints move forward whether the seat is occupied or not.

#### **Warning!**

Do not attach any objects (e.g. hangers) to the head restraint posts. Otherwise, the active head restraints may not be able to function properly or offer the intended degree of protection they were designed for in the event of a rear-end collision.

If the active head restraints have been triggered in an accident, the active head restraints must be reset. Otherwise, the active head restraints cannot offer any additional protection in the event of another rear-end collision.

For information on resetting the activated active head restraints, see “Resetting activated head restraints” (> page 345).

You cannot remove the active head restraint on the driver's and front passenger's seats.

#### **Warning!**

Only use seat or head restraint covers which have been tested and approved by Mercedes-Benz for your vehicle model.

Using other seat or head restraint covers may interfere with or prevent the activation of the active head restraints and/or the deployment of the front side impact air bags.

Contact an authorized Mercedes-Benz Center for availability.

#### **Warning!**

For your protection, drive only with properly positioned head restraints.

Adjust the head restraint so that it is as close to the head as possible and the center of the head restraint supports the back of the head at eye level. This will reduce the potential for injury to the head and neck in the event of an accident or similar situation.

For information on head restraint adjustment, see “Head restraints” (> page 97).

### Correct driver seat adjustment

#### **⚠ Warning!**

In order to avoid possible loss of vehicle control, all seat, head restraint, steering wheel, and rear view mirror adjustments, as well as fastening of seat belts, must be done before the vehicle is put into motion.



- ① Steering wheel
- ② Seat belt
- ③ Seat

#### Steering wheel

**⚠ Observe Safety notes, see page 105.**

- ▶ Position steering wheel ① properly (▷ page 105).

Make sure:

- You can reach steering wheel ① with your arms slightly bent at the elbows.
- You can move your legs freely.
- All displays (including malfunction and indicator lamps) on the instrument cluster are clearly visible.

#### Seat belt

**⚠ Observe Safety notes, see page 55.**

- ▶ Fasten and position your seat belt ② (▷ page 57) correctly.

Make sure:

- Seat belt ② is always fitted snugly.
- Adjust seat belt ② so that the shoulder section is located as close as possible to the middle of the shoulder.
- Place the lap portion of seat belt ② as low as possible on your hips.

#### Seat and head restraint

**⚠ Observe Safety notes, see page 95.**

- ▶ Position seat ③ (▷ page 96) and head restraint properly (▷ page 97).

### Occupant safety

Observe the following points:

- Always be in a properly seated position.
- The position should be as far rearward from the front air bag in steering wheel ① as possible, while still permitting proper operation of vehicle controls.
- Adjust seat ③ to a comfortable seating position that still allows you to reach the accelerator/brake pedal safely.
- Seat ③ must be adjusted so that you can correctly fasten and position your seat belt ②.
- The seat backrest must be in a position that is as nearly upright as possible.
- Adjust the seat cushion so that the front edge of the seat cushion lightly supports your legs.
- Adjust the head restraint so that it is as close to the head as possible and the center of the head restraint supports the back of the head at eye level.
- Never place hands under seat ③ or near any moving parts while seat ③ is being adjusted.

### Children in the vehicle

#### Safety notes

If an infant or child is traveling with you in the vehicle:

- ▶ Secure the child using an infant or child restraint appropriate to the age and size of the child.
- ▶ Make sure the infant or child is properly secured at all times while the vehicle is in motion.

#### **Warning!**

When leaving the vehicle, always remove the SmartKey from the starter switch. Always take the SmartKey with you and lock the vehicle. Do not leave children unattended in the vehicle, even if they are secured in a child restraint system, or with access to an unlocked vehicle. A child's unsupervised access to a vehicle could result in an accident and/or serious personal injury. The children could

- injure themselves on parts of the vehicle
- be seriously or fatally injured through excessive exposure to extreme heat or cold
- injure themselves or cause an accident with vehicle equipment that can be operated even if the SmartKey is removed from the starter switch or removed from the vehicle, such as seat adjustment, steering wheel adjustment, or the memory function.

If children open a door, they could injure other persons or get out of the vehicle and injure themselves or be injured by following traffic.



Do not expose the child restraint system to direct sunlight. The child restraint system's metal parts, for example, could become very hot, and the child could be burned on these parts.

### **Warning!**

Do not carry heavy or hard objects in the passenger compartment, or trunk (sedan), or cargo compartment (wagon) unless they are firmly secured in place.

Unsecured or improperly positioned cargo increases a child's risk of injury in the event of

- strong braking maneuvers
- sudden changes of direction
- an accident

For more information on loading, please refer to the "Loading and storing" (> page 200) chapter.

## **Infant and child restraint systems**

### **Observe Safety notes, see page 62.**

We recommend all infants and children be properly restrained at all times while the vehicle is in motion.

All lap/shoulder belts except the driver's seat belt have special seat belt retractors for secure fastening of child restraints.

To fasten a child restraint, follow child restraint instructions for mounting. Then pull the shoulder belt out completely and let it retract. During seat belt retraction, a ratcheting sound can be heard to indicate that the special seat belt retractor is activated. The seat belt is now locked. Push down on child restraint to take up any slack.

To deactivate, release the seat belt buckle and let the seat belt retract completely. The seat belt can again be used in the usual manner.

### **Warning!**

Never release the seat belt buckle while the vehicle is in motion, since the special seat belt retractor will be deactivated.

-  Information on child seats with mounting fittings for tether anchorages (> page 65).

For information on LATCH-type child seat anchors (> page 68).

The use of infant or child restraints is required by law in all 50 states, the District of

Columbia, the U.S. territories and all Canadian provinces.

Infants and small children should be seated in an appropriate infant or child restraint system, properly secured in accordance with the manufacturer's instructions for the child restraint, that complies with U.S. Federal Motor Vehicle Safety Standards 213 and 225 and Canadian Motor Vehicle Safety Standards 213 and 210.2.

A statement by the child restraint manufacturer of compliance with these standards can be found on the instruction label on the restraint and in the instruction manual provided with the restraint.

When using any infant restraint, toddler restraint, or booster seat, make sure to carefully read and follow all manufacturer's instructions for installation and use.

Please read and observe warning labels affixed to the inside of the vehicle and to infant or child restraints.

### **Warning!**

According to accident statistics, children are safer when properly restrained in the rear seating positions than in the front seating position. Thus, we strongly recommend that children be placed in the



### Occupant safety

rear seats whenever possible. Regardless of seating position, children 12 years old and under must be seated and properly secured in an appropriate infant restraint, toddler restraint, or booster seat recommended for the size and weight of the child.







The infant or child restraint must be properly secured with the vehicle's seat belt, the seat belt and top tether strap, or lower anchors and top tether strap, fully in accordance with the child seat manufacturer's instructions.

Occupants, especially children, should always sit as upright as possible, wear the seat belt properly and use an appropriately sized infant restraint, toddler restraint, or booster seat recommended for the size and weight of the child.

Children can be killed or seriously injured by an inflating air bag. Note the following important information when circumstances require you to place a child in the front passenger seat:



- Your vehicle is equipped with air bag technology designed to deactivate the front passenger front air bag in your vehicle when the system senses the

weight of a typical 12-month-old child or less along with the weight of a standard appropriate child restraint on the front passenger seat.

- A child in a rear-facing child restraint on the front passenger seat will be seriously injured or even killed if the front passenger front air bag inflates in a collision which could occur under some circumstances, even with the air bag technology installed in your vehicle. The only means to completely eliminate this risk is to never place a child in a rear-facing child restraint in the front seat. We therefore strongly recommend that you always place a child in a rear-facing child restraint in a backseat.
- If you must install a rear-facing child restraint on the front passenger seat because circumstances require you to do so, make sure the   indicator lamp is illuminated, indicating that the front passenger front air bag is deactivated. Should the   indicator lamp not illuminate or go out while the restraint is installed, please check installation. Periodically check the   indicator lamp while

driving to make sure the

  indicator lamp is

illuminated. If the   indicator lamp goes out or remains out, do not transport a child on the front passenger seat until the system has been repaired.

A child in a rear-facing child restraint on the front passenger seat will be seriously injured or even killed if the front passenger front air bag inflates.

- If you have to place a child in a forward-facing child restraint on the front passenger seat, move the seat as far back as possible, use the proper child restraint recommended for the age, size and weight of the child, and secure child restraint with the vehicle's seat belt according to the child seat manufacturer's instructions. For children larger than the typical 12-month-old child, the front passenger front air bag may or may not be activated.

#### **Warning!**

Infants and small children should never share a seat belt with another occupant. During an accident, they could be crushed between the occupant and seat belt.

A child's risk of serious or fatal injuries is significantly increased if the child restraints are not properly secured in the vehicle and/or the child is not properly secured in the child restraint.

Children too big for a toddler restraint must ride in seats using regular seat belts. Position shoulder belt across chest and shoulder, not face or neck. A booster seat may be necessary to achieve proper seat belt positioning for children over 41 lb (18 kg) until they reach a height where a lap/shoulder belt fits properly without a booster.

When the child restraint is not in use, remove it from the vehicle or secure it with the seat belt to prevent the child restraint from becoming a projectile in the event of an accident.

### Installation of infant and child restraint systems

**⚠ Observe Safety notes, see page 62.**

This vehicle is equipped with tether anchorages for a top tether strap at each of the rear seating positions.

Top tether straps enable an additional connection to be made between child restraint systems secured with LATCH-type anchors and rear seats. This can further reduce the risk of injury.

#### Sedan: Non foldable rear seat backrest



① Anchorage ring cover

- ▶ Remove anchorage ring cover ① from the anchorage ring of the seat on which a child seat is to be installed.
- ▶ Store anchorage ring cover ① in a convenient place (e.g. glove box).

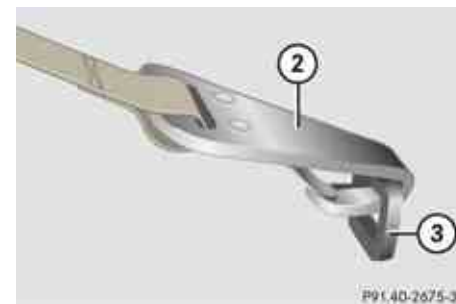

② Hook

③ Anchorage ring

- ▶ Guide the top tether strap between the head restraint and top of the seat backrest. The head restraint must be positioned such that the top tether strap can pass freely between the head restraint and the top of the seat backrest.
- ▶ Make sure the top tether strap is not twisted.
- ▶ Securely fasten hook ②, which is part of the top tether strap, to anchorage ring ③.
- ▶ For safety, make sure hook ② is attached to anchorage ring ③ beyond the safety catch, as illustrated.

## Occupant safety

Once hook ② is attached, the child restraint itself can be secured.

- ▶ Install the child restraint system and tighten the top tether strap according to the child restraint manufacturer's instructions.

After removing the child restraint system and the top tether strap.

- ▶ Reinstall anchorage ring cover ①.

### Sedan: Foldable rear seat backrest

#### **Warning!**

Always lock the seat backrest in its upright position when the rear seat bench is occupied by passengers, after installing top tether straps, or the extended cargo compartment is not in use. Make sure that seat backrest is secured properly by pushing and pulling on the seat backrest. If the seat backrest is not locked properly, the seat backrest could fold. The child seat would no longer be supported properly or positioned to provide its intended benefit. That could cause serious or even fatal injuries.

- ▶ Release the respective rear seat backrest (▷ page 205).
- ▶ Fold the rear seat backrest slightly forward.
- ▶ Remove anchorage ring cover ① from the anchorage ring of the seat on which a child seat is to be installed.
- ▶ Store anchorage ring cover ① in a convenient place (e.g. glove box).

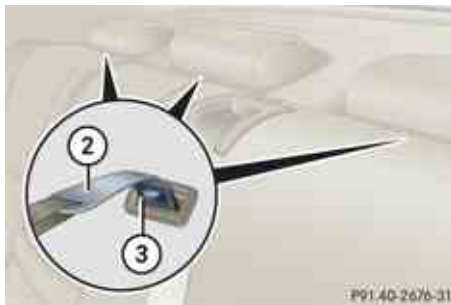

- ② Hook
- ③ Anchorage ring

- ▶ Guide the top tether strap between the head restraint and top of the seat back. The head restraint must be installed and positioned such that the top tether strap can pass freely between the head restraint and the top of the seat back.
- ▶ Make sure the tether strap is not twisted.

- ▶ Securely fasten hook ②, which is part of the top tether strap, to anchorage ring ③.
- ▶ For safety, make sure hook ② is attached to anchorage ring ③ beyond the safety catch, as illustrated.

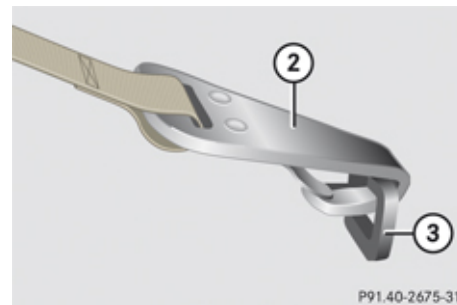

- ② Hook
- ③ Anchorage ring

- ▶ Swing the rear seat backrest to the rear until it engages.
- ▶ Check the rear seat backrest to be locked in its upright position (▷ page 316).

Once hook ② is attached, the child restraint itself can be secured.

- ▶ Install the child restraint system and tighten the top tether strap according to

## Occupant safety

the child restraint manufacturer's instructions.

After removing the child restraint system and the top tether strap.

- ▶ Reinstall anchorage ring cover ①.

## Wagon

**⚠ Warning!**

Always lock the seat backrest in its upright position when the rear seat bench is occupied by passengers, after installing top tether straps, or the extended cargo compartment is not in use. Make sure that seat backrest is secured properly by pushing and pulling on the seat backrest. If the seat backrest is not locked properly, the seat backrest could fold. The child seat would no longer be supported properly or positioned to provide its intended benefit. That could cause serious or even fatal injuries.

Prior to installing a tether strap, note the following steps:

- ▶ Roll up the retractable luggage cover and the partition net.
- ▶ Remove the storage box (if so equipped).

If the storage box is not removed

- the top tether anchorage ring ② located on the floor for use with a child restraint in the rear center seat position cannot be accessed
  - the hook ③ of the top tether strap when attached to the anchorage ring ② on an outer rear seat backrest may push against the storage box and prevent the seat backrest from properly locking into position
- ▶ If you place a child seat in the left or center rear seat position, remove the twin roller blind and return the seat to its original position.
- !** Do not reinstall the twin roller blind with a child seat and top tether installed in the left and/or center rear seat position.
- ▶ If you place a child seat in the right rear seat position, the twin roller blind can remain installed if so desired.
  - ▶ With a child seat and top tether installed in the right rear seat position and the twin roller blind installed, make sure the top tether strap is positioned between the seat backrest and the twin roller blind.
  - ▶ Fold the rear seat backrest slightly forward.

- ▶ Guide the top tether strap between the head restraint and top of the seat back. The head restraints must be installed (if removable) and positioned such that the top tether strap can pass freely between the head restraint and top of the seat back.
  - ▶ Make sure the tether strap is not twisted.
- Anchorage rings ② are located on the back side of the rear outer seat backrests and on the floor behind the rear center seat.

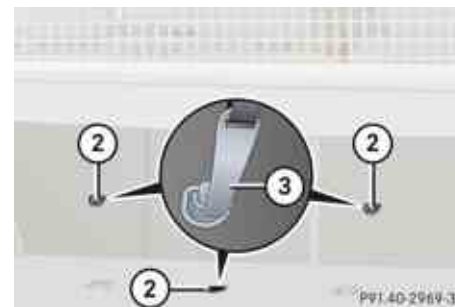

② Anchorage rings

③ Hook

- ▶ Fold up anchorage ring ②.
- ▶ Securely fasten hook ③, which is part of the top tether strap, to anchorage ring ②.

## Occupant safety

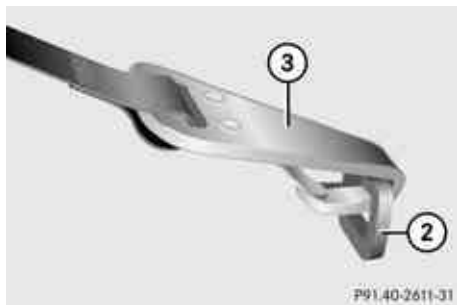

② Anchorage ring

③ Hook

► For safety, make sure hook ③ has attached to anchorage ring ② beyond the safety catch, as illustrated.

► Swing the rear seat backrest to the rear until it engages.

► Check the rear seat backrest to be locked in its upright position (▷ page 316).

Once hook ③ is attached, the child restraint itself can be secured.

► Install the child restraint system and tighten the top tether strap according to the child restraint manufacturer's instructions.

## Child seat anchors – LATCH-type

**⚠ Observe Safety notes, see page 62.**

This vehicle is equipped with two LATCH-type anchors (at each of the rear outer seats) for the installation of a LATCH-type child seat with matching mounting fittings.

**⚠ Warning!**

Children too big for a toddler restraint must ride in seats using regular seat belts. Position shoulder belt across chest and shoulder, not face or neck.

A booster seat may be necessary to achieve proper seat belt positioning for children over 41 lb (18 kg) until they reach a height where a lap/shoulder belt fits properly without a booster.

Install child seat according to manufacturer's instructions.

The child seat must be firmly attached to the right and left side anchors.

An incorrectly mounted child seat may come loose during an accident which could result in serious injury or death to the child. Damaged or impact damaged child seats or child seat mounting fittings must be replaced.

Non-LATCH-type child seats may also be used and can be installed using the vehicle's seat belt system. Install child seat according to the manufacturer's instructions.

The LATCH-type anchors are covered with upholstery blends.



① Indicates the position of the anchors

② Anchors

► Fold the upholstery blend upward to access anchors ②.

► Install a LATCH-type child seat according to the manufacturer's instructions.

A rigid connection between the child seat and the body of the vehicle is established.

**!** Make sure the seat belt for the center seat can operate freely with a child seat installed.

## Child safety

### Override switch

**⚠ Observe Safety notes, see page 62.**

With the override switch you can disable the rear door window switches in the rear door panels.

#### **⚠ Warning!**

Activate the override switch when children are riding in the back seats of the vehicle. The children may otherwise injure themselves, e.g. by becoming trapped in the window opening.

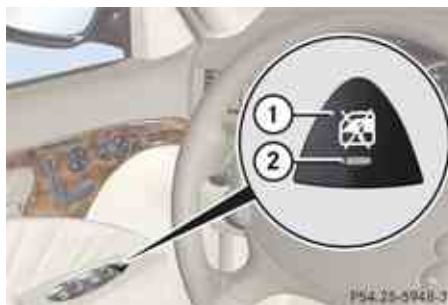

- ① Override switch
- ② Indicator lamp

► **Activating:** Press override switch ①. Indicator lamp ② comes on.

The rear door windows can no longer be operated using the respective switch located in the rear doors.

It is still possible to operate the rear door windows using the switches located on the door control panel of the driver's door.

► **Deactivating:** Press override switch ① again.

Indicator lamp ② goes out.

The rear door windows can again be operated using the respective switch located in the rear doors.

For more information on power windows, see the “Controls in detail” section (▷ page 120).

## Driving safety systems

### Panic alarm



① PANIC button

**i** USA only:

This device complies with Part 15 of the FCC Rules. Operation is subject to the following two conditions:

1. This device may not cause harmful interference, and
2. this device must accept any interference received, including interference that may cause undesired operation.

Any unauthorized modification to this device could void the user's authority to operate the equipment.

**i** Canada only:

This device complies with RSS-210 of Industry Canada. Operation is subject to the following two conditions:

1. This device may not cause interference, and
2. this device must accept any interference received, including interference that may cause undesired operation of the device.

Any unauthorized modification to this device could void the user's authority to operate the equipment.

▶ **Activating:** Press and hold button ① for at least 1 second.

An audible alarm and flashing exterior lamps will operate briefly.

▶ **Deactivating:** Press button ① again.

or

▶ Insert the SmartKey in the starter switch.

or

▶ Press the KEYLESS-GO start/stop button. The SmartKey with KEYLESS-GO must be inside the vehicle.

## Driving safety systems

### Introduction

This section contains information about the following driving safety systems:

- ABS (Antilock Brake System)
- Adaptive Brake
- BAS (Brake Assist System)
- EBP (Electronic Brake Proportioning)
- ESP® (Electronic Stability Program)

**i** In winter operation, the maximum effectiveness of most of the driving systems described in this section is only achieved with winter tires, or snow chains as required.

### Safety notes

#### **Warning!**

The following factors increase the risk of accidents:

- Excessive speed, especially in turns
- Wet and slippery road surfaces
- Following another vehicle too closely

The driving safety systems described in this section cannot reduce these risks or



## Driving safety systems

prevent the natural laws of physics from acting on the vehicle. They cannot increase braking or steering efficiency beyond that afforded by the condition of the vehicle brakes and tires or the traction afforded.

Only a safe, attentive, and skillful driver can prevent accidents.

The capabilities of a vehicle equipped with the driving safety systems described in this section must never be exploited in a reckless or dangerous manner which could jeopardize the user's safety or the safety of others.

Always adjust your driving style to the prevailing road and weather conditions and keep a safe distance to other road users and objects on the street.

If a driving system malfunctions, other driving safety systems may also switch off. Observe indicator and warning lamps that may come on as well as messages in the multifunction display that may appear.

**ABS**

 **Observe Safety notes, see page 70.**

 **Warning!**

Do not pump the brake pedal. Use firm, steady brake pedal pressure instead. Pumping the brake pedal defeats the purpose of the ABS and significantly reduces braking effectiveness.

The Antilock Brake System (ABS) regulates the brake pressure so that the wheels do not lock during braking. This allows you to maintain the ability to steer your vehicle.

The ABS is functional above a speed of approximately 5 mph (8 km/h) independent of road surface conditions.

On slippery road surfaces, the ABS will respond even to light brake pressure.

The  indicator lamp in the instrument cluster comes on when you switch on the ignition. It goes out when the engine is running.

**Braking**

At the instant one of the wheels is about to lock up, a slight pulsation can be felt in the

brake pedal, indicating that the ABS is in the regulating mode.

- ▶ Keep firm and steady pressure on the brake pedal while you feel the pulsation.

Continuous, steady brake pedal pressure yields the advantages provided by the ABS, namely braking power and the ability to steer the vehicle.

The pulsating brake pedal can be an indication of hazardous road conditions and functions as a reminder to take extra care while driving.

**Emergency brake maneuver**

- ▶ Keep continuous full pressure on the brake pedal.

 **Warning!**

If the ABS malfunctions, other driving safety systems such as the BAS or the ESP® are also switched off. Observe indicator and warning lamps that may come on as well as messages in the multifunction display that may appear.

If the ABS malfunctions, the wheels may lock during hard braking, reducing steering capability and extending the braking distance.

## Driving safety systems

For more information, see “What to do if ...?” (▷ page 331).

### BAS

 **Observe Safety notes, see page 70.**

The Brake Assist System (BAS) operates in emergency situations. If you apply the brakes very quickly, the BAS automatically provides full brake boost, thereby potentially reducing the braking distance.

- ▶ Apply continuous full braking pressure until the emergency braking situation is over. The ABS will prevent the wheels from locking.

When you release the brake pedal, the brakes function again as normal. The BAS is then deactivated.

### **Warning!**

If the BAS malfunctions, the brake system still functions, but without the additional brake boost available that the BAS would normally provide in an emergency braking maneuver. Therefore, the braking distance may increase.

### Adaptive Brake

Adaptive Brake provides a high level of braking safety as well as increased braking comfort. It is coupled with the ABS, the ESP® and the BAS. Adaptive Brake takes driver and vehicle characteristics into consideration, thus achieving an optimal braking effect.

For more information on the brake system, see (▷ page 275).

### EBP

 **Observe Safety notes, see page 70.**

The Electronic Brake Proportioning (EBP) enhances braking effectiveness by allowing the rear brakes to supply a greater proportion of the braking effort in straight line braking without a loss of vehicle stability.

### **Warning!**

If the EBP malfunctions, the brake system will still function with full brake boost. However, the rear wheels could lock up during emergency braking situations, for example. You could lose control of the vehicle and cause an accident.

Adapt your driving style to the changed driving characteristics.

### ESP®

 **Observe Safety notes, see page 70.**

The Electronic Stability Program (ESP®) is operational as soon as the engine is running and monitors the vehicle's traction (force of adhesive friction between the tires and the road surface) and handling.

The ESP® recognizes when a wheel is spinning or if the vehicle starts to skid. By applying brakes to individual wheels and by limiting the engine output, the ESP® works to stabilize the vehicle. The ESP® is especially useful while driving off and on wet or slippery road surfaces. The ESP® also stabilizes the vehicle during braking and steering maneuvers.

The ESP® warning lamp  in the instrument cluster comes on when you switch on the ignition. It goes out when the engine is running.

The ESP® warning lamp  in the instrument cluster flashes when the ESP® is engaged.

## Driving safety systems

**⚠ Warning!**

Never switch off the ESP<sup>®</sup> when you see the ESP<sup>®</sup> warning lamp  flashing in the instrument cluster. In this case proceed as follows:

- When driving off, apply as little throttle as possible.
- While driving, ease up on the accelerator pedal.
- Adapt your speed and driving style to the prevailing road conditions.

Failure to observe these guidelines could cause the vehicle to skid. The ESP<sup>®</sup> cannot prevent accidents resulting from excessive speed.

**! Vehicles with 4MATIC:**

Only conduct operational or performance tests on a two-axle dynamometer. If such tests are necessary, contact an authorized Mercedes-Benz Center. You could otherwise seriously damage the brake system or the transfer case which is not covered by the Mercedes-Benz Limited Warranty.

**! Vehicles with 4MATIC:**

Because the ESP<sup>®</sup> operates automatically, the engine and ignition must be shut off (SmartKey in starter switch position **0** or **1** or KEYLESS-GO start/stop button in position **0** or **1**) when the parking brake is being tested on a brake test dynamometer.

Active braking action through the ESP<sup>®</sup> may otherwise seriously damage the brake system which is not covered by the Mercedes-Benz Limited Warranty.

**! Vehicles without 4MATIC:**

Because the ESP<sup>®</sup> operates automatically, the engine and ignition must be shut off (SmartKey in starter switch position **0** or **1** or KEYLESS-GO start/stop button in position **0** or **1**) when the parking brake is being tested on a brake test dynamometer or the vehicle is being towed with the front axle raised.

Active braking action through the ESP<sup>®</sup> may otherwise seriously damage the brake system which is not covered by the Mercedes-Benz Limited Warranty.

**! The ESP<sup>®</sup> will only function properly if you use wheels of the recommended tire size as specified in the “Technical data” section of this Operator’s Manual.**

- i** The DISTRONIC system and cruise control switch off automatically when the ESP<sup>®</sup> engages.

**Electronic Traction System (ETS/4-ETS)****⚠ Observe Safety notes, see page 70.**

The ETS (Electronic Traction System) and 4-ETS (four-wheel Electronic Traction System, vehicles with 4MATIC only) are components of the ESP<sup>®</sup>. The ETS/4-ETS improves the vehicle’s ability to utilize available traction, especially under slippery road conditions by applying the brakes to a spinning wheel. Vehicles with 4MATIC also transfer more power to the wheel(s) with traction.

Except E 63 AMG:

When you switch off the ESP<sup>®</sup>, the ETS/4-ETS is still enabled.

## Driving safety systems

### Switching off the ESP®



① ESP® switch

### Switching off the ESP® (except E 63 AMG)

#### **Warning!**

The ESP® should not be switched off during normal driving other than in the circumstances described below. Disabling the system will reduce vehicle stability in driving maneuvers.

Do not switch off the ESP® when a spare wheel is mounted.

To improve the vehicle's traction, switch off the ESP® in driving situations in which it would be advantageous to have the drive wheels spin and thus cut into surfaces for better grip such as:

- when driving with snow chains
- in deep snow
- in sand or gravel

#### **Warning!**



Switch on the ESP® immediately if the aforementioned circumstances do not apply anymore. Otherwise the ESP® will not stabilize the vehicle when it is starting to skid or a wheel is spinning.

When you switch off the ESP®,

- the ESP® does not stabilize the vehicle
- the engine output is not limited, which allows the drive wheels to spin and thus cut into surfaces for better grip
- the ETS/4-ETS will still apply the brakes to a spinning wheel
- the ESP® continues to operate when you are braking

- you cannot activate the cruise control or the DISTRONIC system
- the cruise control or the DISTRONIC system switch off if activated

**i** When the ESP® is switched off and one or more drive wheels are spinning, the ESP® warning lamp  in the instrument cluster flashes. However, the ESP® will then not stabilize the vehicle.

- ▶ With the engine running, press ESP® switch  until the ESP® warning lamp  in the instrument cluster comes on. The ESP® is switched off.

#### **Warning!**

When the ESP® warning lamp  is illuminated continuously, the ESP® is switched off or is not operational due to a malfunction. Vehicle stability in standard driving maneuvers is reduced.

Adapt your speed and driving to the prevailing road conditions and to the non-operating status of the ESP®.

**!** Avoid spinning of a drive wheel for an extended period with the ESP® switched off. This may cause serious damage to the

## Driving safety systems

drivetrain which is not covered by the Mercedes-Benz Limited Warranty.

### Switching off the ESP® (E 63 AMG only)

#### Warning!

The ESP® should not be switched off during normal driving.

Disabling of the system will result in the following:

- no restriction to engine torque
- loss of system supported traction control

“ESP® OFF” is designed for driving on closed tracks when the vehicle’s natural oversteer and understeer characteristics are desired and requires a highly skilled and experienced driver able to handle these critical driving situations.

You could lose control of your vehicle and cause an accident.



Please be aware of these limits when you switch off the ESP®.

Do not switch off the ESP® when a spare wheel is mounted.

When you switch off the ESP®,

- the ESP® does not stabilize the vehicle
- the engine output is not limited, which allows the drive wheels to spin
- the ETS will still apply the brakes to a spinning wheel
- the ESP® operates while you are braking
- you cannot activate the cruise control or the DISTRONIC system
- the cruise control or DISTRONIC system switch off if currently activated

**i** When the ESP® is switched off and one or more drive wheels are spinning, the ESP® warning lamp  in the instrument cluster flashes. However, the ESP® will then not stabilize the vehicle.

▶ With the engine running, press ESP® switch  until the ESP® warning lamp  in the instrument cluster comes on. The ESP® is switched off.

#### Warning!



When the ESP® warning lamp  is illuminated continuously, the ESP® is switched off or is not operational due to a

malfunction. Vehicle stability in standard driving maneuvers is reduced.

Adapt your speed and driving to the prevailing road conditions and to the non-operating status of the ESP®.

**!** Avoid spinning of a drive wheel for an extended period with the ESP® switched off. This may cause serious damage to the drivetrain which is not covered by the Mercedes-Benz Limited Warranty.

### Switching on the ESP®

▶ Press ESP® switch  until the ESP® warning lamp  in the instrument cluster goes out. You are now again in normal driving mode with the ESP® switched on.

## Anti-theft systems

### Anti-theft systems

#### Immobilizer

The immobilizer prevents unauthorized persons from starting your vehicle.

When leaving the vehicle, always take the SmartKey with you and lock the vehicle. The engine can be started by anyone with a valid SmartKey that is left inside the vehicle.

#### Activating

- ▶ **With SmartKey:** Remove the SmartKey from the starter switch.
- ▶ **With KEYLESS-GO:** Turn off the engine and open the driver's door.

#### Deactivating

- ▶ Switch on the ignition.
- i** Starting the engine will also deactivate the immobilizer.  
In the event that the engine cannot be started (yet the vehicle's battery is charged), the system is not operational. Contact an authorized Mercedes-Benz Center or call 1-800-FOR-MERCEdes (in the USA), or 1-800-387-0100 (in Canada).

### Anti-theft alarm system

Once the alarm system has been armed, a visual and audible alarm is triggered when someone opens

- a door
- the trunk/the tailgate
- the hood

The alarm will stay on even if the activating element (a door, for example) is immediately closed.

The alarm system will also be triggered when

- the vehicle is opened with the mechanical key
- a door is opened from the inside
- the trunk is opened with the emergency release button (sedan only)

To cancel the alarm after it has been triggered, see "Canceling the alarm" (▶ page 77).

- i** If the alarm stays on for more than 30 seconds, a call to the Response Center is initiated automatically by the Tele Aid system provided that you have subscribed to the Tele Aid service and that it has been activated properly, and that the necessary

mobile phone, power supply and GPS coverage are available.



① Indicator lamp

- ▶ **Arming:** Lock the vehicle with the SmartKey or with KEYLESS-GO. The turn signal lamps flash three times and an acoustic warning sounds three times to indicate that the vehicle is locked. Indicator lamp ① flashes to indicate that the alarm system is armed.
- i** If the turn signal lamps do not flash three times and the acoustic warning does not sound three times, a door or the trunk/tailgate may not be properly closed.



Close the respective element.

- ▶ **Disarming:** Unlock the vehicle with the SmartKey or with KEYLESS-GO.  
The turn signal lamps flash once and an acoustic warning sounds once to indicate that the alarm system is disarmed.

**i** The vehicle will lock and the alarm system will rearm automatically again after approximately 40 seconds unless you open a door or the trunk/tailgate.

### Canceling the alarm

To cancel the alarm, do one of the following:

- ▶ Insert the SmartKey in the starter switch.
- ▶ Press button  or  on the SmartKey.

In vehicles with KEYLESS-GO:

- ▶ Grasp an outside door handle.  
The SmartKey must be within 3 ft (1 m) of the vehicle.
- ▶ Press the KEYLESS-GO start/stop button.  
The SmartKey must be inside the vehicle.





Vehicle equipment .....	80	Automatic transmission .....	130
Locking and unlocking .....	80	Instrument cluster .....	138
Starter switch positions .....	94	Control system .....	139
Seats .....	95	Driving systems .....	160
Multifunction steering wheel .....	105	Climate control system .....	179
Mirrors .....	107	Rear window defroster .....	193
Memory function .....	109	Power tilt/sliding sunroof .....	194
Lighting .....	110	Panorama roof with power tilt/ sliding panel (sedan) .....	197
Wipers .....	118	Loading and storing .....	200
Power windows .....	120	Useful features .....	219
Driving and parking .....	124		

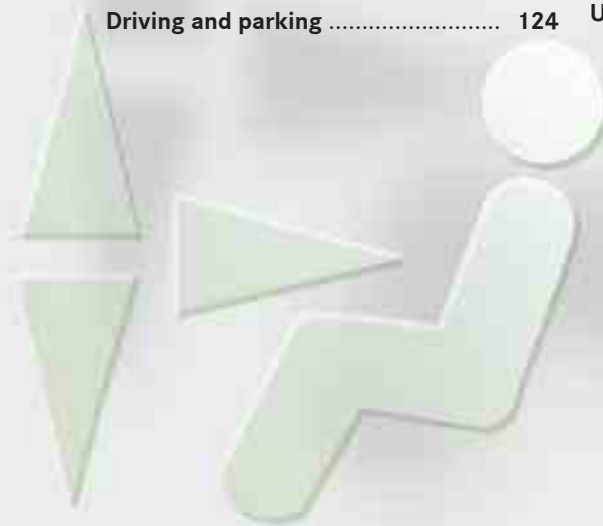

## Locking and unlocking

### Vehicle equipment

**i** This Operator's Manual describes all features, standard or optional, potentially available for your vehicle at the time of purchase. Please be aware that your vehicle might not be equipped with all features described in this manual.

### Locking and unlocking

#### Notes

**⚠ Observe Safety notes, see page 62.**

When unlocking or locking the vehicle with the SmartKey an acoustic signal sounds. The acoustic signal is activated at the factory. If you wish to deactivate the feature, or adjust its signal volume, contact an authorized Mercedes-Benz Center.

When unlocking the vehicle, all turn signal lamps flash once, an acoustic signal sounds once, the locking knobs in the doors move up, and the anti-theft alarm system is disarmed.

When locking the vehicle, all turn signal lamps flash three times, an acoustic signal sounds three times, the locking knobs in the doors move down, and the anti-theft alarm system is armed.

All doors and the trunk/tailgate must be closed.

**!** If you cannot lock or unlock the vehicle with the SmartKey, the batteries in the SmartKey are discharged, the SmartKey is malfunctioning, or the vehicle battery is drained.

- Check the batteries in the SmartKey and replace them if necessary.
- Use the mechanical key to unlock the driver's door and the trunk (sedan only).
- Use the mechanical key to lock the vehicle.
- Have the vehicle battery and the vehicle battery connections checked at an authorized Mercedes-Benz Center.

If the SmartKey is malfunctioning, contact Roadside Assistance or an authorized Mercedes-Benz Center.

### SmartKey

Your vehicle comes supplied with two SmartKeys, each with remote control and a removable mechanical key.

The SmartKey centrally locks and unlocks:

- the doors
- the trunk lid/tailgate
- the fuel filler flap

## Locking and unlocking



- ① Lock button
- ② Unlock button for trunk lid/tailgate
- ③ Unlock button
- ④ Battery check lamp

### **i** USA only:

This device complies with Part 15 of the FCC Rules. Operation is subject to the following two conditions:

1. This device may not cause harmful interference, and
2. this device must accept any interference received, including interference that may cause undesired operation.

Any unauthorized modification to this device could void the user's authority to operate the equipment.

### **i** Canada only:

This device complies with RSS-210 of Industry Canada. Operation is subject to the following two conditions:

1. This device may not cause interference, and
2. this device must accept any interference received, including interference that may cause undesired operation of the device.

Any unauthorized modification to this device could void the user's authority to operate the equipment.

### Factory setting

- ▶ **Global unlocking:** Press button . The vehicle will lock again automatically and rearm the anti-theft alarm system within approximately 40 seconds of unlocking if neither door nor trunk/tailgate is opened.
- ▶ **Global locking:** Press button .

### Selective setting

If you frequently travel alone, you may wish to reprogramm the SmartKey so that pressing

button only unlocks the driver's door and the fuel filler flap.

- ▶ **Switching on/off:** Press and hold buttons and simultaneously for approximately 6 seconds until battery check lamp ④ (▷ page 81) flashes twice.

The SmartKey will then function as follows:

- ▶ **Unlocking driver's door and fuel filler flap:** Press button once.
- ▶ **Global unlocking:** Press button twice.
- ▶ **Global locking:** Press button .

### KEYLESS-GO

Vehicles equipped with KEYLESS-GO come with two SmartKeys with KEYLESS-GO, each with remote control and a removable mechanical key.

The KEYLESS-GO function is integrated into the SmartKey. The validity of the SmartKey is checked every time you pull an outside door handle.

### Locking and unlocking

When the SmartKey is valid, your vehicle unlocks

- the doors
- the fuel filler flap
- the trunk lid/tailgate

#### **i** USA only:

This device complies with Part 15 of the FCC Rules. Operation is subject to the following two conditions:

1. This device may not cause harmful interference, and
2. this device must accept any interference received, including interference that may cause undesired operation.

Any unauthorized modification to this device could void the user's authority to operate the equipment.

#### **i** Canada only:

This device complies with RSS-210 of Industry Canada. Operation is subject to the following two conditions:

1. This device may not cause interference, and
2. this device must accept any interference received, including interference that may cause undesired operation of the device.

Any unauthorized modification to this device could void the user's authority to operate the equipment.

### **Important notes on using KEYLESS-GO**

- You can also use the SmartKey with KEYLESS-GO like a normal SmartKey (▷ page 80).
- You can combine KEYLESS-GO functions with normal SmartKey functions (e.g. unlocking with KEYLESS-GO and locking with button ).
- Always carry the SmartKey with you.
- Never store the SmartKey together with:

- Electronic items such as a mobile phone or another SmartKey
- Metallic objects such as coins or metal foil

Doing so could impair the function of the KEYLESS-GO system.

- To lock or unlock the vehicle, the SmartKey must be located outside the vehicle within approximately 3 ft (1 m) of a door or the trunk/tailgate.
- If the SmartKey is positioned farther away from the vehicle, the system may no longer recognize the SmartKey. The vehicle cannot be locked or the engine started via the KEYLESS-GO system.
- If the SmartKey is removed from the vehicle (e.g. if a passenger exits the vehicle with the SmartKey)
  - when pressing the KEYLESS-GO start/stop button or trying to lock the vehicle with the lock button on an outside door handle the message Key Not Detected appears in the multifunction display
  - with the engine running, the message Key Not Detected appears in the multifunction display while driving off

## Locking and unlocking

Find the SmartKey or change its present location immediately (e.g. place it on the front passenger seat or insert it in shirt pocket).

- If you have started the engine with the KEYLESS-GO start/stop button, you can turn it off again by
  - pressing the KEYLESS-GO start/stop button
  - inserting the SmartKey into the starter switch when the vehicle is at a standstill and the automatic transmission is in park position **P**
- The vehicle could be inadvertently unlocked if the SmartKey is within 3 ft (1 m) of the vehicle and
  - an outside door handle is splashed with water  
or
  - you attempt to clean an outside door handle
- Remember that the engine can be started by anyone with a SmartKey that is left inside the vehicle.

**Possibility 1** (One SmartKey in the vehicle, one SmartKey outside the vehicle):

If you leave the SmartKey behind when exiting and locking the vehicle, no message appears in the multifunction display.

**Possibility 2** (One SmartKey in the vehicle, no SmartKey outside the vehicle):

When exiting and trying to lock the vehicle, the message *Key Detected In Vehicle* appears in the multifunction display. The vehicle will not be locked.

### Factory setting

- ▶ **Global unlocking:** Pull an outside door handle.

The vehicle will lock again automatically and rearm the anti-theft alarm system within approximately 40 seconds if neither door nor trunk/tailgate is opened.



- ① Lock button on the outside door handle

- ▶ **Global locking:** Press lock button ① on an outside door handle.



- ① Lock button on the tailgate (wagon)

- ▶ **Global locking with the lock button on the tailgate (wagon):** Press lock button ① on the tailgate.



### Locking and unlocking

If the vehicle was previously centrally locked with the SmartKey or KEYLESS-GO, the tailgate will lock automatically when it is closed.

To prevent a possible inadvertent lockout, the tailgate will open automatically if a SmartKey is recognized inside the vehicle or in the cargo compartment.

### Selective setting



If you frequently travel alone, you may wish to reprogram the SmartKey so when you pull the driver's outside door handle, only the driver's door and the fuel filler flap unlock.

- ▶ **Switching on/off:** Press and hold buttons  and  simultaneously for approximately 6 seconds until battery check lamp ④ (▷ page 81) flashes twice.

The SmartKey will then function as follows:

- ▶ **Unlocking driver's door and fuel filler flap:** Pull the driver's outside door handle.
- ▶ **Global unlocking:** Pull any outside door handle other than the driver's outside door handle.
- ▶ **Global locking:** Press lock button ① on an outside door handle.



### Checking SmartKey batteries

- ▶ Press button  or  on the SmartKey.  
Battery check lamp ④ (▷ page 81) comes on briefly to indicate that the SmartKey batteries are in order.

If the battery check lamp does not come on briefly during check, the SmartKey batteries are discharged.

- ▶ Replace the batteries (▷ page 346).

**i** You can obtain the required batteries at any authorized Mercedes-Benz Center.

**i** If the batteries are checked within signal range of the vehicle, pressing button  or  will lock or unlock the vehicle accordingly.

### Loss of the SmartKey

If you lose your SmartKey or mechanical key, you should do the following:

- ▶ Have the SmartKey deactivated by an authorized Mercedes-Benz Center.
- ▶ Report the loss of the SmartKey or the mechanical key to your car insurance company immediately.
- ▶ Have the mechanical lock replaced if necessary.

Any authorized Mercedes-Benz Center will be glad to supply you with a replacement.

### Opening the doors from the inside

You can open a locked door from the inside. Open door only when conditions are safe to do so.

## Locking and unlocking



Example illustration driver's door

- ① Locking knob
- ② Inside door handle

If the vehicle has previously been locked with the SmartKey or with KEYLESS-GO, opening a door from the inside will trigger the anti-theft alarm system.

To cancel the alarm, see (▷ page 77).

- ▶ **Front doors:** Pull on inside door handle ② on the respective front door to open door.  
If the door was locked, locking knob ① will move up.
- ▶ **Rear doors:** Pull up locking knob on the respective rear door to unlock door.
- ▶ Pull on inside door handle on the respective rear door to open door.

### Automatic central locking

The doors and the trunk/tailgate lock automatically when the vehicle is set into motion.

You can open a locked door from the inside. Open door only when conditions are safe to do so.

The doors are designed to unlock automatically after an accident if the force of the impact exceeds a preset threshold. The vehicle locks automatically when the ignition is switched on and the wheels are turning at vehicle speeds of approximately 9 mph (15 km/h) or more. You could therefore lock yourself out when the vehicle is pushed or towed or is on a test stand.

You can deactivate the automatic central locking using the control system (▷ page 155).

### Locking and unlocking from the inside

**⚠ Observe Safety notes, see page 62.**

You can lock or unlock the vehicle from inside using the central locking switches. This can be useful, for example, if you want to lock the vehicle before starting to drive.

The central locking switches do not lock or unlock the fuel filler flap.

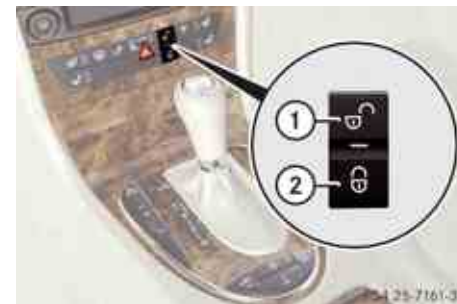

- ① Central unlocking switch
- ② Central locking switch

### Locking and unlocking

- ▶ **Locking:** Press central locking switch ②. If all doors and the trunk/tailgate are closed, the vehicle locks.
- ▶ **Unlocking:** Press central unlocking switch ①.

You can open a locked door from inside at any time. Open door only when conditions are safe to do so.

If the vehicle was previously locked with the central locking switch:

- and the SmartKey is set to factory settings, the complete vehicle is unlocked when a door is opened from the inside
- and the SmartKey is set to selective settings, only the door opened from inside is unlocked

If the vehicle was previously locked centrally with the SmartKey or with KEYLESS-GO, it will not unlock using the central unlocking switch.

### Opening the trunk/tailgate

#### **Warning!**

Make sure the trunk/tailgate is closed when the engine is running and while driving. Among other dangers, deadly carbon monoxide (CO) gases may enter vehicle interior resulting in unconsciousness and death.

You can open the trunk/tailgate when the vehicle is stationary.

A minimum height clearance of 5.90 ft (1.80 m) sedan or 6.81 ft (2.07 m) wagon is required to open the trunk lid/tailgate.

 Vehicles with trunk/tailgate opening/closing system:

The trunk lid/tailgate swings open upwards automatically. Always make sure there is sufficient overhead clearance.

### Opening the trunk/tailgate from the outside



Trunk lid handle (Example sedan)

① Handle

#### **Vehicles without trunk/tailgate opening/closing system**

▶ **Sedan:** Press and hold button  on the SmartKey until trunk unlocks and begins to open.

or

▶ Pull on handle ①.

In vehicles without KEYLESS-GO: The vehicle must be unlocked.

**Sedan:** If the trunk does not open, it is still locked separately (▷ page 93).

▶ **Wagon:** Lift the tailgate.



## Locking and unlocking

### Vehicles with trunk/tailgate opening/closing system

- ▶ Press and hold button  on the SmartKey until trunk/tailgate unlocks and begins to open.

or

- ▶ Pull on handle ①.

In vehicles without KEYLESS-GO: The vehicle must be unlocked.

**Sedan:** If the trunk does not open, it is still locked separately (▷ page 93).

- ▶ **Stopping the opening procedure:** Press button  on the SmartKey.

### Opening the trunk/tailgate from the inside

#### Opening from the inside automatically (sedan)

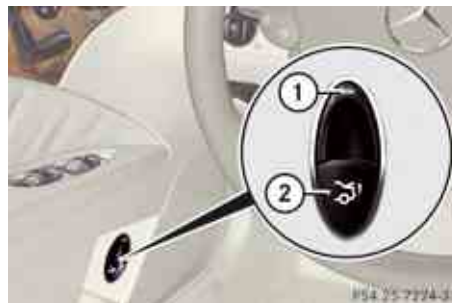

Vehicles without trunk opening/closing system

- ① Indicator lamp
- ② Remote trunk opening switch

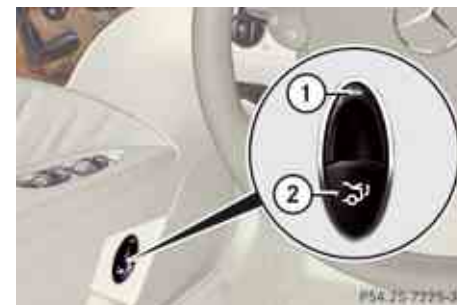

Vehicles with trunk opening/closing system

- ① Indicator lamp
- ② Remote trunk opening/closing switch

- ▶ Pull switch ② until the trunk begins to open. Indicator lamp ① comes on and remains lit until the trunk is closed.

If the trunk does not open, it is still locked separately (▷ page 93).

- ▶ **Vehicles with trunk opening/closing system:** To stop the opening procedure, press or pull switch ②.

## Locking and unlocking

### Opening from the inside automatically (wagon)



① Indicator lamp

② Remote tailgate opening switch

- ▶ Pull and hold switch ② until
  - the tailgate is completely open (opened to its full extent)
  - or
  - the tailgate has reached the desired opening angle

Indicator lamp ① comes on. It remains lit until the tailgate is closed.

- ❗ The tailgate swings open upwards as long as you pull and hold the switch. Always make sure there is sufficient overhead

clearance. To stop the opening procedure, release switch.

### Opening from the inside with handle (wagons with third-row seat only)

#### ⚠ Warning!

Do not leave children unattended in the vehicle. Children could open the tailgate from the inside, which could result in an accident and/or serious personal injury.

- ❗ Always make sure there is sufficient overhead clearance.



① Handle

② Catch

- ▶ **Unlocking/opening:** Move catch ② to the right.

- ▶ Pull handle ① down and swing tailgate upward.

- ▶ **Locking:** Move catch ② to the left.

### Limiting opening height of tailgate (wagon)

Tailgate with opening/closing system:

The tailgate opening height can be limited when transporting goods on a roof rack (e.g. presence of an optional MB sport luggage container). When activated, the tailgate opens to approximately the height of the roof edge.

### Activating

- ▶ **Open tailgate:** Pull on handle (▶ page 86) or press and hold button  on the SmartKey until the tailgate opens.

- ▶ **Stop opening procedure:** When the tailgate is in the desired position, pull tailgate closing switch (▶ page 91) or press button  on the SmartKey once more.

- ❗ You can also press or pull the remote tailgate opening switch (▶ page 88) to stop the opening procedure.

## Locking and unlocking

- ▶ Move the tailgate to the desired opening height.
- ▶ Press and hold the tailgate closing switch (> page 91) until an acoustic signal sounds once.  
The opening height of the tailgate is limited. When you now open the tailgate it will stop at the stored position.

If the acoustic signal does not sound, the position could not be stored.

- ▶ Open the tailgate further and press and hold the tailgate closing switch once more until an acoustic signal sounds once.

**Deactivating**

- ▶ Press and hold the tailgate closing switch until an acoustic signal sounds twice.

**Closing the trunk/tailgate****⚠ Warning!**

Make sure the trunk/tailgate is closed when the engine is running and while driving. Among other dangers, deadly carbon monoxide (CO) gases may enter vehicle interior resulting in unconsciousness and death.

**⚠ Warning!**

To prevent possible personal injury, always keep hands and fingers away from the trunk/cargo compartment opening when closing the trunk lid/tailgate. Be especially careful when small children are around.

**⚠ Observe Safety notes, see page 62.**

Do not leave the SmartKey in the vehicle. You may lock yourself out.

If the vehicle was previously centrally locked with the SmartKey or KEYLESS-GO, the trunk lid/tailgate will lock automatically when closed. All turn signal lamps flash three times and an acoustic signal sounds three times to confirm locking.

Vehicles with KEYLESS-GO:

To prevent a possible inadvertent lockout, the trunk lid/tailgate will open automatically if a SmartKey with KEYLESS-GO is recognized inside the vehicle.

The vehicle is only locked when the turn signal lamps flash three times. If you are carrying a second SmartKey with KEYLESS-GO with you, you can still lock the vehicle.

**Closing the trunk/tailgate from the outside manually**

Sedan

① Handles

## Locking and unlocking



Wagon

① Handles

- ▶ Lower trunk lid/tailgate by pulling firmly on handles ①.
- ▶ Close trunk/tailgate with hands placed flat on trunk lid/tailgate.

### Closing the tailgate from the inside manually (wagon)

Vehicles with folding third-row seats have a strap on the tailgate to close it from the inside.



① Strap

### Closing the trunk from the inside automatically (sedan)

#### **⚠ Warning!**

Maintain sight of the area around the rear of the vehicle while operating the trunk lid with the door mounted switch. Monitor the closing procedure carefully to make sure no one is in danger of being injured.

To interrupt the closing procedure, press or pull the door mounted remote trunk opening/closing switch.

Even with the SmartKey removed from the starter switch or the SmartKey with KEYLESS-GO removed from the vehicle, the remote trunk opening/closing switch can

be operated. Therefore, do not leave children unattended in the vehicle, or with access to an unlocked vehicle. A child's unsupervised access to a vehicle could result in an accident and/or serious personal injury.

If the trunk lid comes into contact with an object while closing (e.g. luggage that has been piled too high) in the upper motion sequence, the closing procedure is stopped and the trunk reopens slightly.

In vehicles with trunk opening/closing system you can close the trunk from the inside using the remote trunk opening/closing switch.



① Indicator lamp

② Remote trunk opening/closing switch

## Locking and unlocking

- ▶ Press switch ② until indicator lamp ① goes out and the trunk is closed.

To interrupt the closing procedure:

- ▶ Release switch ②.

### Closing the trunk/tailgate from the outside automatically

#### **⚠ Warning!**

Monitor the closing procedure carefully to make sure no one is in danger of being injured. To prevent possible personal injury, always keep hands and fingers away from the trunk/cargo compartment opening when closing the trunk lid. Be especially careful when small children are around. To stop the closing procedure, do one of the following:

- Press button  on the SmartKey.
- Press or pull the remote trunk opening/closing switch (on the driver's door).
- Press or pull the remote tailgate opening switch (on the driver's door).
- Press the trunk/tailgate closing switch.

- Press the KEYLESS-GO locking/closing switch.

- Pull the trunk lid/tailgate handle.

Sedan:

Even with the SmartKey removed from the starter switch or the SmartKey with KEYLESS-GO removed from the vehicle, the remote trunk opening/closing switch can be operated. Therefore, do not leave children unattended in the vehicle, or with access to an unlocked vehicle. A child's unsupervised access to a vehicle could result in an accident and/or serious personal injury.

In vehicles with trunk/tailgate opening/closing system you can close the trunk/tailgate separately from the outside using the trunk/tailgate closing switch.



Example illustration: Sedan without KEYLESS-GO  
① Trunk closing switch



Example illustration: Wagon without KEYLESS-GO  
① Tailgate closing switch

- ▶ Press switch ① briefly.  
The trunk/tailgate closes.



### Locking and unlocking

Wagon: While the tailgate closes, an acoustic signal sounds.

If the trunk lid/tailgate comes into contact with an object while closing (e.g. luggage that has been piled too high) in the upper motion sequence, the closing procedure is stopped and the trunk lid/tailgate reopens slightly.

#### Closing the trunk/tailgate and locking vehicle from outside (vehicles with KEYLESS-GO)

In vehicles with trunk/tailgate opening/closing system and KEYLESS-GO, you can close the trunk/tailgate and lock the vehicle simultaneously from the outside using the KEYLESS-GO locking/closing switch.



Sedan

① KEYLESS-GO locking/closing switch



Wagon

① KEYLESS-GO locking/closing switch

- ▶ Make sure you have the SmartKey with KEYLESS-GO with you.
- ▶ Press switch ① briefly.

With all doors closed:

- The locking knobs in the doors move down.
- The trunk/tailgate starts to close automatically.

Wagon: While the tailgate closes, an acoustic signal sounds.

- All turn signal lamps flash three times to confirm locking once the trunk/tailgate has closed completely.

- An acoustic signal sounds three times.
- The anti-theft alarm system is armed.

If the trunk lid/tailgate comes into contact with an object while closing (e.g. luggage that has been piled too high) in the upper motion sequence, the closing procedure is stopped and the trunk lid/tailgate reopens slightly.

#### Trunk lid emergency release (sedan)

With the emergency release button, the trunk lid can be opened from inside the trunk.



① Emergency release button

- ▶ Briefly press emergency release button ①.  
The trunk lid unlocks and opens.

## Locking and unlocking

The emergency release button unlocks and opens the trunk while the vehicle is standing still or in motion.

Illumination of the emergency release button:

- The button flashes for 30 minutes after opening the trunk.
- The button flashes for 60 minutes after closing the trunk.

The emergency release button does not open the trunk, if the vehicle battery is discharged or disconnected.

If the vehicle has previously been centrally locked with the SmartKey or KEYLESS-GO, opening the trunk from the inside using the emergency release button will trigger the anti-theft alarm system.

To cancel the alarm, see (▷ page 77).

## Valet locking (sedan)

To deny any unauthorized person access to the trunk, e.g. when you valet park the vehicle, lock it separately with the mechanical key. Leave only the SmartKey less its mechanical key with the vehicle.



1 Neutral position

2 Locked

- ▶ **Valet locking:** Close the trunk.
- ▶ Remove the mechanical key from the SmartKey (▷ page 343).
- ▶ Insert the mechanical key in the trunk lid lock.
- ▶ Turn the mechanical key clockwise to position 2 and remove the mechanical key in that position to lock the trunk.

The trunk remains locked even when the vehicle is centrally unlocked.

You can only cancel the separate trunk locking mode by means of the mechanical key.

- ▶ **Canceling:** Insert the mechanical key in the trunk lid lock.
- ▶ Turn the mechanical key counterclockwise to neutral position 1 and remove the mechanical key in that position to unlock the trunk.  
You can now open the trunk.



## Starter switch positions

### Starter switch positions

#### SmartKey

⚠ Observe Safety notes, see page 62.



#### Starter switch

- 0 For removing SmartKey (gear selector lever must be in park position **P**)
- 1 Power supply for some electrical consumers, e.g. radio
- 2 Ignition (power supply for all electrical consumers) and driving position
- 3 Starting position

When you switch on the ignition, all lamps (except low-beam headlamp indicator lamp, high-beam headlamp indicator lamp, and turn signal indicator lamps unless activated) in the instrument cluster come on. If a lamp in the

instrument cluster fails to come on when the ignition is switched on, have it checked and replaced if necessary. If a lamp in the instrument cluster remains on after starting the engine or comes on while driving, refer to “Lamps in instrument cluster” (▷ page 330).

If the SmartKey is left in starter switch position **0** for an extended period of time, it can no longer be turned in the starter switch. In this case, the steering is locked. To unlock, remove SmartKey from the starter switch and reinsert.

The steering is locked when the SmartKey is removed from the starter switch.

❗ If the SmartKey cannot be turned in the starter switch, the vehicle battery may not be sufficiently charged.

- Check the vehicle battery and charge it if necessary.
- Get a jump start.

To prevent accelerated vehicle battery discharge or a completely discharged vehicle battery, always remove the SmartKey from the starter switch when the engine is not in operation.

### KEYLESS-GO

⚠ Observe Safety notes, see page 62.

Vehicles equipped with the KEYLESS-GO feature are supplied with a SmartKey with integrated KEYLESS-GO function.

With the SmartKey present in the vehicle, pressing the KEYLESS-GO start/stop button

- without the brake pedal depressed corresponds to the various starter switch positions (▷ page 94)
- with the brake pedal firmly depressed will start the engine (▷ page 124)

The function of the SmartKey overrules the KEYLESS-GO function.

The SmartKey must be located in the vehicle.

- ▶ Make sure the automatic transmission is in park position **P**.
- ▶ Do not depress the brake pedal.





KEYLESS-GO start/stop button

- ① USA only
- ② Canada only

### Position 0

Before you press the KEYLESS-GO start/stop button, the vehicle's on-board electronics have status **0** (as with SmartKey removed).

### Position 1

- ▶ Press the KEYLESS-GO start/stop button once.  
This supplies power for some electrical consumers, such as radio functions.

- ① If you now press the KEYLESS-GO start/stop button
  - once more, the ignition (position **2**) is switched on
  - twice more the power supply is again switched off

### Ignition (or position 2)

- ▶ Press the KEYLESS-GO start/stop button twice.  
This supplies power for all electrical consumers.  
All lamps (except low-beam headlamp indicator lamp, high-beam headlamp indicator lamp, and turn signal indicator lamps unless activated) in the instrument cluster come on. If a lamp in the instrument cluster fails to come on when the ignition is switched on, have it checked and replaced if necessary. If a lamp in the instrument cluster remains on after starting the engine or comes on while driving, refer to "Lamps in instrument cluster" (▶ page 330).

- ① If you now press the KEYLESS-GO start/stop button once, the power supply is again switched off.

### Seats

#### Safety notes

#### **Warning!**

In order to avoid possible loss of vehicle control, all seat, head restraint, steering wheel, and rear view mirror adjustments, as well as fastening of seat belts, must be done before the vehicle is put into motion.

#### **Warning!**

Do not adjust the driver's seat while driving. Adjusting the seat while driving could cause the driver to lose control of the vehicle.

Never ride in a moving vehicle with the seat backrest in an excessively reclined position as this can be dangerous. You could slide under the seat belt in a collision. If you slide under it, the seat belt would apply force at the abdomen or neck. That could cause serious or fatal injuries. The seat backrest and seat belts provide the best restraint when the wearer is in a position that is as upright as possible and seat belts are properly positioned on the body.

## Seats

### **Warning!**

Your seat must be adjusted so that you can correctly fasten your seat belt.

Observe the following points:

- Adjust the seat backrest until your arms are slightly angled when holding the steering wheel.
- Adjust the seat to a comfortable seating position that still allows you to reach the accelerator/brake pedal safely. The position should be as far back as possible with the driver still able to operate the controls properly.
- Adjust the head restraint so that it is as close to the head as possible and the center of the head restraint supports the back of the head at eye level.
- Never place hands under the seat or near any moving parts while a seat is being adjusted.

Failure to do so could result in an accident and/or serious personal injury.

### **Warning!**

The power seats can be operated at any time. Therefore, do not leave children unattended in the vehicle, or with access to

an unlocked vehicle. A child's unsupervised access to a vehicle could result in an accident and/or serious personal injury.

### **Warning!**

According to accident statistics, children are safer when properly restrained in the rear seating positions than in the front seating position. Thus, we strongly recommend that children be placed in the rear seats whenever possible. Regardless of seating position, children 12 years old and under must be seated and properly secured in an appropriately sized infant restraint, toddler restraint, or booster seat recommended for the size and weight of the child. For additional information, see "Children in the vehicle".

A child's risk of serious or fatal injuries is significantly increased if the child restraints are not properly secured in the vehicle and/or the child is not properly secured in the child restraint.

### **Warning!**

For your protection, drive only with properly positioned head restraints.

Adjust the head restraint so that it is as close to the head as possible and the center

of the head restraint supports the back of the head at eye level. This will reduce the potential for injury to the head and neck in the event of an accident or similar situation.

Do not drive the vehicle without the seat head restraints. Head restraints are intended to help reduce injuries during an accident.

For more information on folding the seats, see "Loading and storing" (▷ page 205).

## Seat adjustment

-  When moving the seats, make sure there are no items in the footwell or behind the seats. Otherwise, you could damage the seats.

## Power seats

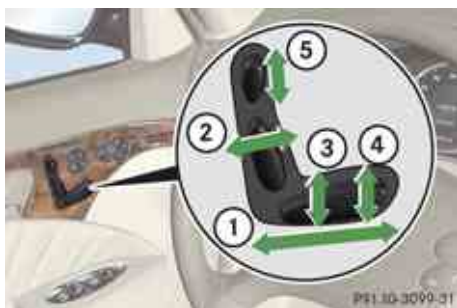

- ① Seat fore and aft adjustment
- ② Seat backrest tilt
- ③ Seat height
- ④ Seat cushion tilt
- ⑤ Head restraint height

**i** The memory function (▷ page 109) lets you store the settings for the seat position together with the settings for the steering wheel and the exterior rear view mirrors.

▶ **Seat fore and aft adjustment:** Press the switch forward or backward in direction of arrow ①.

**i** When moving the seat fore or aft, the head restraints may readjust automatically.

- ▶ **Seat backrest tilt:** Press the switch forward or backward in direction of arrow ②.
- ▶ **Seat height:** Press the switch up or down in direction of arrow ③.
- ▶ **Seat cushion tilt:** Press the switch up or down in direction of arrow ④ until your upper legs are lightly supported.
- ▶ **Head restraint height:** Press the switch up or down in direction of arrow ⑤.

## Head restraint fore and aft adjustment



- ▶ While seated, reach behind you with both hands and find upper edge of the head restraint.
- ▶ Adjust the head restraint to the desired position by pushing or pulling on the upper edge of the head restraint cushion.

## Comfort head restraint

**⚠ Warning!**

When folding back the side cushions, never reach between the side cushion and the mounting post. You could otherwise be trapped.

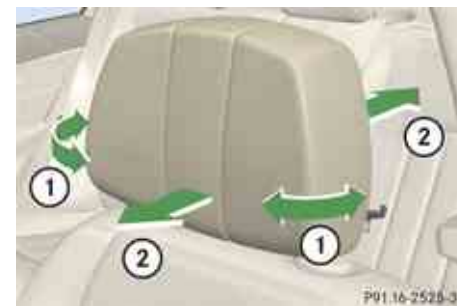

- ① Side cushions
- ② Fore and aft adjustment

You can individually adjust the side cushions of the head restraints.



## Seats

- ▶ **Adjusting side cushions:** Pull or push side cushions ① into desired position.
- ▶ **Adjusting forward or backward:** Pull or push head restraint in direction of arrow ②.

### Lumbar support

You can adjust the contour of the front seat's lumbar support to help enhance support to your spine.



① Adjustment lever

- ▶ Move adjustment lever ① in direction of the arrows until you have reached a comfortable seating position.

### Rear seat head restraints

#### ⚠ Warning!

For safety reasons, always drive with the rear head restraints in the upright position when the rear seats are occupied.

Keep the area around head restraints clear of articles (e.g. clothing) to not obstruct the folding operation of the head restraints.

#### ⚠ Warning!

For your protection, drive only with properly positioned head restraints.

Adjust the head restraint in such a way that it is as close to the head as possible and the center of the head restraint supports the back of the head at eye level. This will reduce the potential for injury to the head and neck in the event of an accident or similar situation.

With a rear seat occupied, make sure to move the respective head restraint up from the lowest non-use position and have the occupant adjust the head restraint properly.

Do not drive the vehicle without the seat head restraints installed when the rear seats are occupied. Head restraints are

intended to help reduce injuries during an accident.

#### ⚠ Warning!

Make sure the rear seat head restraints engage when placing them upright manually. Otherwise their protective function cannot be ensured.

The back of the head will not be supported in the event of a collision. That could cause serious or even fatal injuries. Rear seat occupants can be seriously injured or killed.

- ⓘ Sedan: The rear seat head restraints cannot be adjusted.

### Sedan

#### Folding rear seat head restraints back

The rear seat head restraints can be folded backward for increased visibility.



① Head restraint release switch

- ▶ Switch on the ignition.
- ▶ Press the symbol-side on switch ① to release the head restraints.

### Placing rear seat head restraints upright

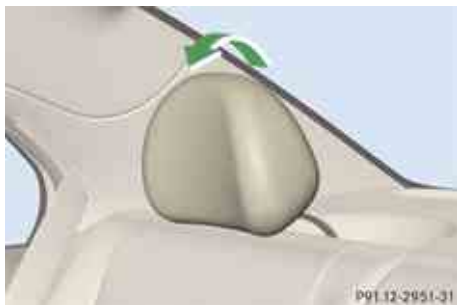

- ▶ Pull the head restraint forward until it locks into position.

### Removing and installing rear seat head restraints (vehicles with split rear seat bench only)

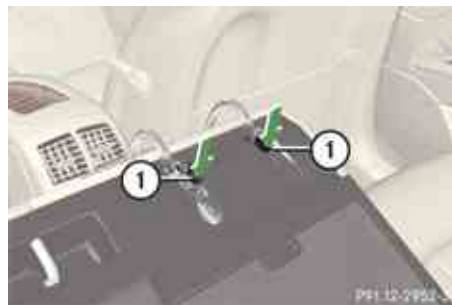

① Release catch

- ▶ **Removing:** Fold the seat backrest forward (▶ page 205).
- ▶ Fold back head restraint (▶ page 98).
- ▶ Press head restraint release catch ① and pull the head restraints out of the guides.
- ▶ Fold the seat backrest back to its original position.
- ▶ **Installing:** Insert head restraint and push it down until it engages.
- ▶ Make sure you place the correct head restraint on the middle seat. It is marked

with the letter “M” on the outside of the metal bars.

- ▶ Make sure the head restraints engage fully.

### Wagon

#### Folding rear seat head restraints back (rear outer seats only)

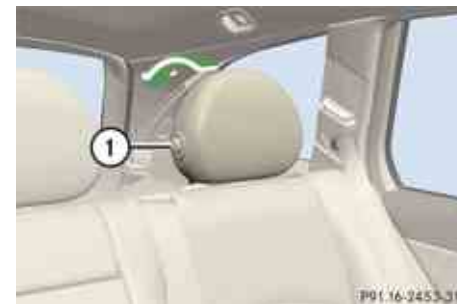

① Release button

- ▶ Press release button ① and fold the head restraints backward.

## Seats

### Placing rear seat head restraints upright



- ▶ Pull the head restraint forward until it locks into position.

### Rear seat head restraint height (rear outer seats only)

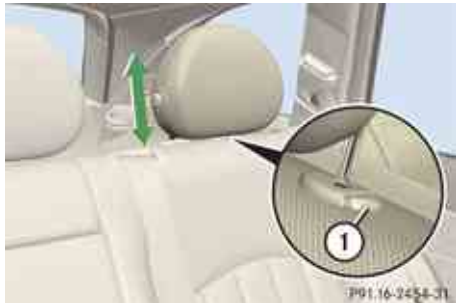

- ① Release button

- ▶ **Raising:** Adjust the height of the head restraint manually by pulling it upward. If the head restraint is fully retracted, press release button ① and pull the head restraint out.
- ▶ **Lowering:** To lower the head restraint, press release button ① and push down on the head restraint.

### Rear seat head restraint tilt (rear outer seats only)

Two different head restraint angle positions are available.

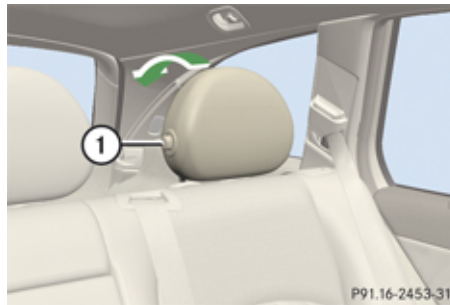

- ① Release button
- ▶ Press release button ① and tilt the head restraint to the desired position.

### Removing and installing rear seat head restraints

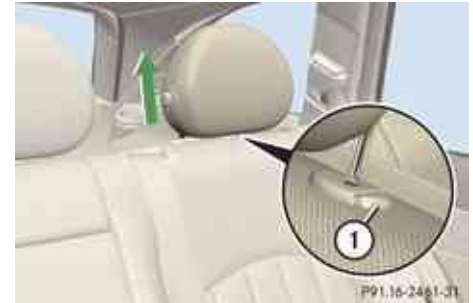

- ① Release button

- ▶ **Removing:** Placing head restraints upright (> page 100).
- ▶ Pull head restraint to its highest position.
- ▶ Press release button ① and pull out head restraint.
- ▶ **Installing:** Insert head restraint and push it down until it engages.
- ▶ Make sure the proper head restraint for each seat is installed. The bars of the head restraint designed for the middle rear seat are of even length and shorter than those designed for use on the outer rear seats.

- ▶ Make sure the head restraints engage fully.
- ▶ Press release button ① and adjust head restraint to desired position.

### Multicontour seat

The multicontour seat has a movable seat cushion and inflatable air cushions built into the seat backrest to provide additional lumbar and side support.

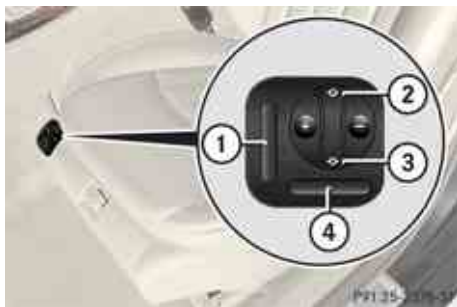

- ① Seat backrest side bolster
- ② Seat backrest center
- ③ Seat backrest bottom
- ④ Seat cushion depth

- ▶ Switch on the ignition.
- ▶ **Seat cushion depth:** Adjust the seat cushion depth to the length of your upper leg using switch ④.
- ▶ **Seat backrest contour:** Adjust the contour of the seat backrest to the desired position using **+** or **-**.
- ▶ Move the seat backrest support cushion to the bottom with button ③ or to the center with button ②.
- ▶ **Seat backrest side bolsters:** Adjust the side bolsters so that they provide good lateral support using switch ①.

- ❗ If, after a period of time, the seat no longer provides the desired contour, then repeat the adjustment procedure.

### Seat ventilation



- ① Seat ventilation switch

The blue indicator lamps in the switch come on to show which ventilation level you have selected.

- ❗ The seat ventilation for the driver's seat can be activated using summer opening feature (▷ page 122).

- ▶ Switch on the ignition.
- ▶ **Switching on:** Press switch ①. Three blue indicator lamps in the switch come on.
- ▶ Press switch ① repeatedly until the desired ventilation level is set.
- ▶ **Switching off:** Press switch ① repeatedly until all indicator lamps go out.



## Seats

If one or more of the indicator lamps in the seat ventilation switch ① are flashing, there is insufficient voltage available since too many electrical consumers are turned on. The seat ventilation switches off automatically.

The seat ventilation will switch back on again automatically as soon as sufficient voltage is available.

### Seat heating



① Front seat heating switch

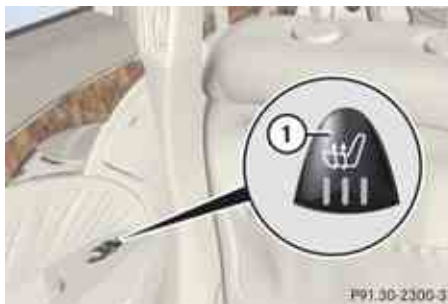

① Rear seat heating switch (Canada only)

Depending on production date, your vehicle may not be equipped with rear seat heating. The red indicator lamps in switch ① come on to show which heating level you have selected.

The seat heating switches from level **3** (high) to level **2** after approximately 5 minutes.

The seat heating switches from level **2** to level **1** (low) after approximately 10 minutes.

The seat heating automatically switches off from level **1** after approximately 20 minutes.

- ▶ Switch on the ignition.
- ▶ **Switching on:** Press switch ①. Three red indicator lamps in switch ① come on.

- ▶ Continue pressing switch ① until desired seat heating level is reached.
- ▶ **Switching off:** Press switch ① repeatedly until all indicator lamps go out.

If one or more of the indicator lamps in seat heating switch ① are flashing, there is insufficient voltage available since too many electrical consumers are turned on. The seat heating switches off automatically.

The seat heating will switch back on again automatically as soon as sufficient voltage is available.

### Third-row seat in cargo compartment (wagon)

The third-row seat in the cargo compartment is approved only for persons up to a height of 4.6 ft (1.40 m) and a maximum weight of 110 lb (50 kg).

The twin roller blind must be installed when the third-row seat is in use.

#### **Warning!**

When using the third-row seat in the cargo compartment, the seats in front of it must be in the driving position.

Only drive when the head restraints for the third-row seat have been properly adjusted.



The head restraints should be adjusted so that the back of the head is supported at approximately eye level. This can reduce a child's risk of injury in the event of an accident.

### **Warning!**

Make sure the seat belt is positioned correctly on the body and is engaged in the seat belt buckle.

Damaged covers should be replaced with original covers only.

Do not leave children unattended in the vehicle, even when they are secured in a child restraint system.

Make sure luggage and other objects are adequately secured. The load could otherwise injure someone in the event of an accident, during hard braking or steering maneuvers.

### Folding out the third-row seat

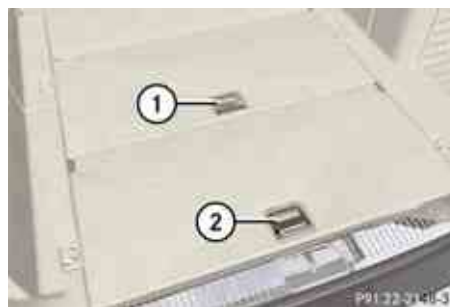

- ① Release handle for seat backrest
- ② Release handle for seat cushion

Before folding out the seat backrest, you must:

- fold the rear seat backrests into an upright position and lock them into place
- move the handle for the twin roller blind into the upper position

① The rear seat backrests can be adjusted to a more reclined position to make the third-row seat more comfortable (▷ page 209).

- ▶ Pull release handle ① and fold seat backrest for the third-row seat upward.

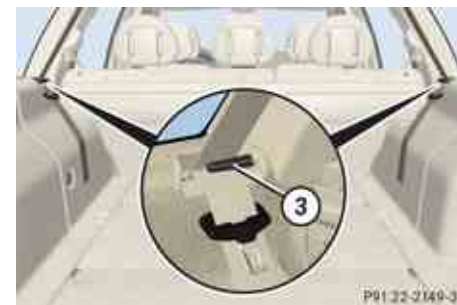

③ Mountings for seat belts

- ▶ Hook seat belts into mountings ③.
- ▶ Pull release handle ② and fold seat cushion for the third-row seat into sitting position.
- ▶ Press seat cushion as far down as it will go. The seat backrest will then also engage properly.
- ▶ Fold head restraints into upright position.

### Removing and installing seat cushions

You must remove the seat cushion when you want to raise the loading floor, e.g. in the event of a flat tire.

## Seats



- ① Seat guides
- ② Seat cushion

► **Removing:** Fold seat cushion ② upward and remove it from seat guides ①.

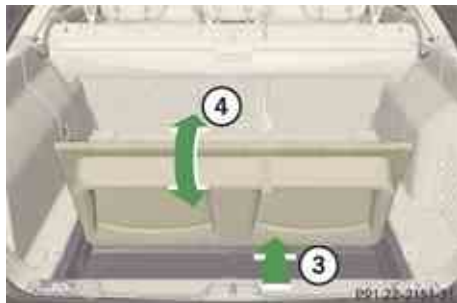

- **Installing:** Insert seat cushion ② into seat guides ① from behind ③ at a slight angle.
- Fold seat cushion ② back into original position ④ until it engages.

### Folding back third-row seat

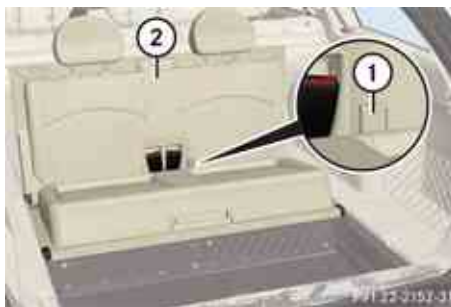

- ① Tab
- ② Seat backrest

► Pull seat cushion upward using tab ① and fold it back into original position until it engages.

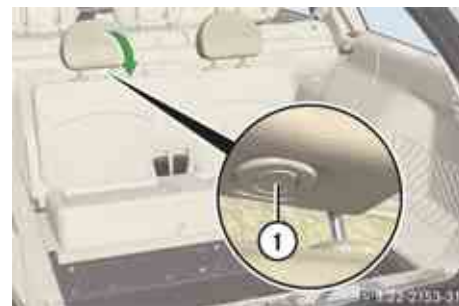

- ① Release knob
- Press release knob ① and fold head restraints down.
- ❗ To avoid damage, insert the head restraints completely into their guides and engage the seat belt buckles in their guides.

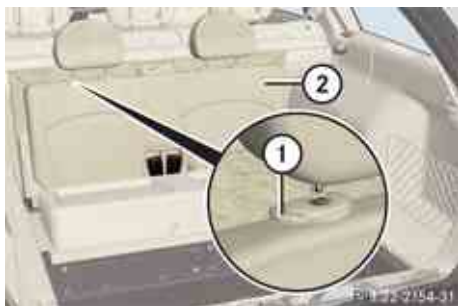

- ① Release catch
- ② Seat backrest

- ▶ Press release catch ① and push head restraints as far in as they will go.
- ▶ Fold seat backrest ② of third-row seat back into original position until it engages.

## Multifunction steering wheel

### Safety notes

#### ⚠ Warning!

Do not adjust the steering wheel while driving. Adjusting the steering wheel while driving could cause the driver to lose control of the vehicle.

The electrical steering wheel adjustment feature can be operated at any time. Therefore, do not leave children unattended in the vehicle, or with access to an unlocked vehicle. A child's unsupervised access to a vehicle could result in an accident and/or serious personal injury.

Make sure

- you can reach the steering wheel with your arms slightly bent at the elbows
- you can move your legs freely
- all displays (including malfunction and indicator lamps) on the instrument cluster are clearly visible

## Multifunction steering wheel

### Steering wheel adjustment



- ① Adjusting steering wheel, in or out
- ② Adjusting steering wheel, up or down

- ▶ **Adjusting steering wheel in or out:** Move stalk in direction of arrows ①.
- ▶ **Adjusting steering wheel up or down:** Move stalk in direction of arrows ②.

- ▶ **i** The memory function (▶ page 109) lets you store the settings for the steering wheel together with the settings for the seat position and the exterior rear view mirrors.

## Multifunction steering wheel

### Easy-entry/exit feature

This feature allows the driver an easier entry into and exit from the vehicle. When entering and exiting the vehicle, the steering wheel is in its uppermost position.

The easy-entry/exit feature can be activated or deactivated in the Convenience submenu of the control system (▷ page 156).

### Warning!

You must make sure no one can become trapped or injured by the moving steering wheel when the easy-entry/exit feature is activated.

To stop steering wheel movement, move steering wheel adjustment stalk or press one of the memory position buttons.

Do not leave children unattended in the vehicle, or with access to an unlocked vehicle. Children could open the driver's door and unintentionally activate the easy-entry/exit feature, which could result in an accident and/or serious personal injury.

With the easy-entry/exit feature activated, the steering wheel will return to its last set position when you close the driver's door with the ignition switched on. The steering wheel will also return to its last set position when you insert the SmartKey into the starter

switch or press the KEYLESS-GO start/stop button once with the driver's door closed.

-  The last set steering wheel position is stored when the ignition is switched off or the position is stored in memory (▷ page 109).

With the easy-entry/exit feature activated, the steering wheel tilts upwards when you remove the SmartKey from the starter switch. The steering wheel also tilts upwards when you open the driver's door with the SmartKey in starter switch position **0** or **1** or the KEYLESS-GO start/stop button in position **1**.

-  When the current position for the steering wheel is in the uppermost tilt position, the steering wheel will no longer be able to move upward when the easy-entry/exit feature is activated.

The adjustment procedure is briefly interrupted when the engine is started.

### Warning!

Let the system complete the adjustment procedure before setting the vehicle in motion. All steering wheel adjustment must be completed before setting the vehicle in motion. Driving off with the steering wheel

still adjusting could cause the driver to lose control of the vehicle.

### Heated steering wheel

The steering wheel heating warms up the leather area of the steering wheel.



- ① Switching on
- ② Switching off
- ③ Indicator lamp

- ▶ Switch on the ignition.
- ▶ **Switching on:** Turn switch at the tip of the stalk in direction of arrow ①. Indicator lamp ③ comes on.

-  The steering wheel heating may be suspended temporarily. However, indicator

## Mirrors

lamp ③ remains on. The steering wheel heating is suspended when the temperature of the vehicle interior is above 86°F (30°C). It is also suspended when the temperature of the steering wheel is above 95°F (35°C).

When these conditions do not apply anymore, steering wheel heating continues.

- ▶ **Switching off:** Turn switch at the tip of stalk in direction of arrow ②. Indicator lamp ③ goes out.
- i** Indicator lamp ③ flashes or goes out in case of power surge or undervoltage or if the steering wheel heating malfunctions.
- i** The steering wheel heating switches off automatically when you remove the SmartKey from the starter switch or, on vehicles with KEYLESS-GO, when you switch off the ignition and open the driver's door.

For more information on the steering wheel, see "Multifunction steering wheel" (▷ page 140).

## Mirrors

## Notes

Adjust the interior and exterior rear view mirrors before driving so that you have a good view of the road and traffic conditions.

## Interior rear view mirror

- ▶ Adjust the interior rear view mirror manually.

## Exterior rear view mirrors

**⚠ Warning!**

Exercise care when using the passenger-side exterior rear view mirror. The mirror surface is convex (outwardly curved surface for a wider field of view). Objects in mirror are closer than they appear. Check your interior rear view mirror and glance over your shoulder before changing lanes.



- ① Driver's side exterior rear view mirror button
- ② Adjustment button
- ③ Passenger-side exterior rear view mirror button

- ▶ Switch on the ignition.
- ▶ Press button ① for the driver's side exterior rear view mirror or button ③ for the passenger-side exterior rear view mirror.
- ▶ Press adjustment button ② up, down, left or right according to the desired setting.

**!** If an exterior rear view mirror was forcibly hit from the front, manually snap it back into place.

## Mirrors

- ① At low ambient temperatures, the exterior rear view mirrors will be heated automatically.

### Auto-dimming rear view mirrors

The exterior rear view mirror on the driver's side and the interior rear view mirror will respond automatically to glare when the ignition is switched on and incoming light from headlamps falls on the sensor in the interior rear view mirror.

The rear view mirrors will not react if the automatic transmission is set to reverse gear **R** or the interior lighting is switched on.

### ⚠ Warning!

The auto-dimming function does not react if incoming light is not aimed directly at the sensors in the interior rear view mirror.

The interior rear view mirror and the exterior rear view mirror on the driver's side do not react, for example,

- if the rear window sunshade is in raised position (sedan)
- when transporting cargo which covers the rear window (wagon)

Light hitting the mirror(s) at certain angles (incident light) could blind you. As a result,

you may not be able to observe traffic conditions and could cause an accident.

### Activating exterior rear view mirror parking position

Follow these steps to activate the mirror parking position so that the passenger-side exterior rear view mirror will be turned downward to the stored position.



- ① Driver's side exterior rear view mirror button
  - ② Passenger-side exterior rear view mirror button
- ▶ Make sure you have stored a parking position for the passenger-side exterior rear view mirror (▶ page 109).
  - ▶ Switch on the ignition.

- ▶ Press button ② for the passenger-side exterior rear view mirror.
- ▶ Shift the automatic transmission into reverse gear **R**.

The passenger-side exterior rear view mirror will be turned downward to the stored position.

The exterior rear view mirror returns to its previously stored driving position:

- 10 seconds after you have put the gear selector lever out of position reverse gear **R**
- immediately once your vehicle exceeds a speed of approximately 6 mph (10 km/h)
- immediately when you press button ① for driver's side exterior rear view mirror.

## Memory function

## Memory function

## Notes

With the memory function you can store up to three different configurations per front seat.

Each memory position button on the driver's side can store all of the following settings:

- Seat position
- Multicontour seat: previously saved setting
- Steering wheel position
- Exterior rear view mirrors' position

**⚠ Warning!**

Do not activate the memory function while driving. Activating the memory function while driving could cause the driver to lose control of the vehicle.

Each memory position button on the front passenger side can store all of the following settings:

- Seat position
- Multicontour seat: previously saved setting



M Memory button  
1, 2, 3 Memory position button

## Storing positions into memory

- ▶ Adjust the seats.
- ▶ On the driver's side, additionally adjust the steering wheel and exterior rear view mirrors to the desired positions.
- ▶ Press memory button **M**.
- ▶ Release memory button **M** and press memory position button **1**, **2** or **3** within 3 seconds.

When the settings are stored to the selected position, an acknowledgement signal sounds.

## Recalling positions from memory

- ▶ Press and hold desired memory position button **1**, **2** or **3** until the seat has completely moved to the stored position. On the driver's side, also wait for the steering wheel and exterior rear view mirrors to move to the stored position.
- i** Releasing the memory position button stops movement to the stored positions immediately.

## Storing exterior rear view mirror parking position

For easier parking, you can adjust the passenger-side exterior rear view mirror so that you can see the right rear wheel as soon as you engage reverse gear **R**.

For information on activating the parking position, see (▶ page 108).



## Lighting



- ① Driver's side exterior rear view mirror button
  - ② Passenger side exterior rear view mirror button
  - ③ Adjustment button
  - ④ Memory button **M**
- ▶ Stop the vehicle.
  - ▶ Switch on the ignition.
  - ▶ Press button ②.  
The passenger-side exterior rear view mirror is selected.
  - ▶ Adjust the passenger-side exterior rear view mirror with adjustment button ③ so that you see the rear wheel and the road curb.

- ▶ Press memory button **M** ④.
  - ▶ Within 3 seconds, press bottom of adjustment button ③.  
The parking position is stored if the mirror does not move.
- i** If the mirror does move, repeat the above steps. After the setting is stored, you can move the mirror again.

## Lighting

### Notes

- i** If you drive in countries where vehicles drive on the other side of the road than the country where the vehicle is registered, you must have the headlamps modified for symmetrical low beams. Relevant information can be obtained at any authorized Mercedes-Benz Center.
- i** Vehicles equipped with active Bi-Xenon headlamps:  
The active Bi-Xenon headlamps monitor the vehicle's steering angle and speed, then automatically shift their beams to either side to better follow the curvature of the road ahead, increasing usable illumination over conventional headlamps.



## Exterior lamp switch

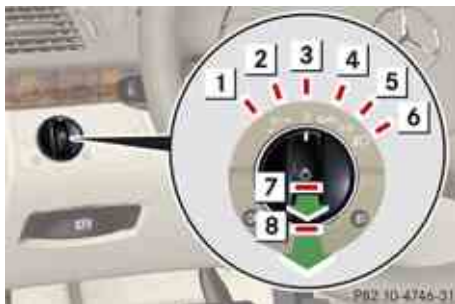

- 1 Standing lamps, left
- 2 Standing lamps, right
- 3 Off  
Daytime running lamp mode
- 4 Automatic headlamp mode  
Daytime running lamp mode
- 5 Parking lamps (also tail lamps, license plate lamps, side marker lamps and instrument panel lamps)
- 6 Low-beam headlamps or high-beam headlamps
- 7 Front fog lamps
- 8 Rear fog lamp

**i** The exterior lamps go out automatically when you remove the SmartKey from the

starter switch or open the driver's door with the ignition switched off.

When the parking lamps or the rear fog lamp are switched on and you remove the SmartKey from the starter switch and open the driver's door, an acoustic signal sounds.

In addition the message Switch Off Lights appears in the multifunction display.

Switch off the parking lamps or the rear fog lamp manually.

**!** Failure to switch off the parking lamps when leaving the vehicle may result in a discharged battery.

### Low-beam headlamps

The low-beam headlamps can be switched on and off with the exterior lamp switch.

- ▶ Switch on the ignition.
- ▶ **Switching on:** Turn the exterior lamp switch to position . The following lamps come on:
  - Low-beam headlamps
  - Tail lamps
  - Parking lamps

- License plate lamps
- Side marker lamps
- Instrument panel lamps
- Green indicator lamp in the instrument cluster

▶ **Switching off:** Turn the exterior lamp switch to position .

### Automatic headlamp mode

The following lamps come on and go out automatically depending on the brightness of the ambient light:

- Low-beam headlamps
- Tail lamps
- Parking lamps
- License plate lamps
- Side marker lamps

### **Warning!**

If the exterior lamp switch is set to **AUTO**, the headlamps will not automatically come on under foggy conditions.

To minimize risk to you and to others, activate headlamps by turning exterior lamp switch to when driving or when

## Lighting

traffic and/or ambient lighting conditions require you to do so.

In low ambient lighting conditions, only switch from position **AUTO** to  with the vehicle at a standstill in a safe location.

Switching from **AUTO** to  will briefly switch off the headlamps. Doing so while driving in low ambient lighting conditions may result in an accident.

The automatic headlamp feature is only an aid to the driver. The driver is responsible for the operation of the vehicle's lights at all times.

- ▶ **Switching on:** Turn the exterior lamp switch to position **AUTO**.

With the SmartKey in starter switch position **1** or the KEYLESS-GO start/stop button pressed once, the tail and parking lamps, the license plate lamps and the side marker lamps will come on and go out depending on the brightness of the ambient light.

When the engine is running the low-beam headlamps, the tail and parking lamps, the license plate lamps and the side marker lamps will come on and go out depending on the brightness of the ambient light.

**Canada only:** High-beam headlamps are only available with the exterior lamp switch in position .

### Daytime running lamp mode

In Canada, the daytime running lamp mode is mandatory and therefore in a constant mode.

In the USA, the daytime running lamp mode is deactivated by default. Activate the daytime running lamp mode using the control system, see “Setting daytime running lamp mode (USA only)” (▷ page 153).

- ▶ Turn the exterior lamp switch to position **0** or **AUTO**.

When the engine is running, the low-beam headlamps come on.

In low ambient lighting conditions, the following lamps will come on additionally:

- Tail lamps
- Parking lamps
- License plate lamps
- Side marker lamps

With the daytime running lamp mode activated and the engine running, you cannot switch off the low-beam headlamps manually.



### Canada only

With the exterior lamp switch in position **0** or **AUTO**, you cannot switch on the high-beam headlamps.

The high-beam flasher is available at all times.



For nighttime driving turn the exterior lamp switch to position  to permit activation of the high-beam headlamps.

When the engine is running, and you

- shift from a driving position to park position **P** with the vehicle at a standstill, the low-beam headlamps will go out with a delay of 3 minutes
- turn the exterior lamp switch to position , the low-beam headlamps, the tail and parking lamps, the license plate lamps and the side marker lamps come on
- turn the exterior lamp switch to position , the manual headlamp mode has priority over the daytime running lamp mode  
The corresponding exterior lamps come on (▷ page 111).

### USA only

You can only switch on the high-beam headlamps in low ambient lighting conditions. The high-beam flasher is available at all times.

When the engine is running, and you turn the exterior lamp switch to position  or , the manual headlamp mode has priority over the daytime running lamp mode. The corresponding exterior lamps come on (▷ page 111).

### Fog lamps





Fog lamps cannot be switched on with the exterior lamp switch in position **AUTO**. To switch on the fog lamps, turn the exterior lamp switch to position  first.

#### **Warning!**

In low ambient lighting or foggy conditions, only switch from position **AUTO** to  with the vehicle at a standstill in a safe location.

Switching from **AUTO** to  will briefly switch off the headlamps. Doing so while driving in low ambient lighting conditions may result in an accident.

Fog lamps will operate with the parking lamps and/or the low-beam headlamps on. Fog lamps should only be used in conjunction with low-beam headlamps. Consult your State or Province Motor Vehicle Regulations regarding permissible lamp operation.

- ▶ Turn the exterior lamp switch to position  or  (▷ page 111).
- ▶ **Switching on front fog lamps:** Pull out the exterior lamp switch to first stop. The green indicator lamp  in the exterior lamp switch comes on.
- ▶ **Switching on rear fog lamp:** Pull out the exterior lamp switch to second stop. The rear fog lamp, the front fog lamps and the yellow indicator lamp  in the exterior lamp switch come on.
- ▶ **Switching off front fog lamps/rear fog lamp:** Push in the exterior lamp switch to its stop.

### Locator lighting and night security illumination



Locator lighting and night security illumination are described in the “Control system” section, see “Setting locator lighting” (▷ page 154) and “Setting night security illumination (Headlamps delayed shut-off feature)” (▷ page 154).

### Combination switch



- ① High beam
- ② High-beam flasher

### High beam

- ▶ Turn the exterior lamp switch to position  (▷ page 111).
- ▶ **Switching on:** Push the combination switch in direction of arrow ①. The high-beam headlamp indicator lamp  in the instrument cluster comes on.
- ▶ **Switching off:** Pull the combination switch in direction of arrow ② to its original position.

## Lighting



### High-beam flasher

- ▶ **Switching on:** Pull the combination switch briefly in direction of arrow ②.

### Turn signals



- ① Turn signals, right
- ② Turn signals, left

- ▶ Press the combination switch in direction of arrow ① or ②. The corresponding turn signal indicator lamp  or  in the instrument cluster flashes.

The combination switch resets automatically after major steering wheel movements.

- ❗ To signal minor directional changes such as changing lanes, press combination

switch only to point of resistance and release. The corresponding turn signal lamps will flash three times.

### Hazard warning flasher

The hazard warning flasher can be switched on at all times, even with the SmartKey removed from the starter switch.

The hazard warning flasher comes on automatically when an air bag deploys.

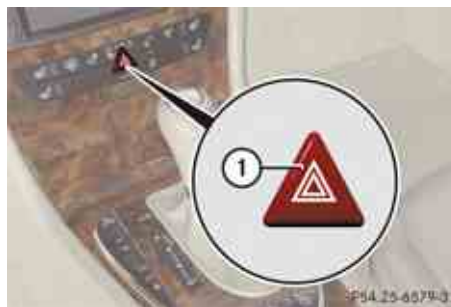

- ① Hazard warning flasher switch

- ▶ **Switching on:** Press hazard warning flasher switch ①. All turn signal lamps are flashing.

- ❗ With the hazard warning flasher activated and the combination switch set for either

left or right turn, only the respective left or right turn signals will operate when the ignition is switched on.

- ▶ **Switching off:** Press hazard warning flasher switch ① again.

- ❗ If the hazard warning flasher has been activated automatically, press hazard warning flasher switch ① once to switch off.

### Headlamp cleaning system

The headlamps will be cleaned with a high-pressure water jet automatically when the engine is running and you have

- switched on the headlamps and
- the windshield wipers have wiped the windshield with washer fluid five times

The counter resets when you switch off the ignition.

For information on filling up the washer reservoir, see “Washer system and headlamp cleaning system” (> page 246).

### Corner-illuminating front fog lamps

The corner-illuminating front fog lamps improve illumination of the area in the direction into which you are turning.

The corner-illuminating front fog lamps will only operate

- in low ambient lighting conditions
- at vehicle speeds below 25 mph (40 km/h)
- with the front fog lamps switched off
- with the engine is running

### Switching on

- ▶ Turn the exterior lamp switch to position  or **AUTO**.

or

- ▶ Activate the daytime running lamp mode (▷ page 112).
- ▶ Switch on the left or right turn signal, depending on whether you are turning left or right.

The respective front fog lamp comes on. If you have switched on the turn signal for one side but turn the steering wheel in the other direction, the corner-illuminating

front fog lamp comes on on the side of the turn signal.

or

- ▶ Turn steering wheel in the desired direction.  
Driving forward: The front fog lamp on the side of your steering direction comes on.  
Driving in reverse: The front fog lamp opposite to your steering direction comes on.

The corner-illuminating front fog lamps will come on automatically depending on the steering angle, even if you did not switch on either turn signal. If the corner-illuminating front fog lamps came on automatically, they will also go out automatically depending on the steering angle and vehicle speed.

The corner-illuminating front fog lamps temporarily come on on both sides of the vehicle if you turn the steering wheel in one direction and then again in the other direction shortly thereafter.

The corner-illuminating front fog lamp remains lit for a maximum of 3 minutes. Afterward, it goes out even if the turn signal is still switched on.

### Switching off

- ▶ Switch off the left or right turn signal.

or

- ▶ Steer straight ahead.

- i** There may be a brief delay before the corner-illuminating front fog lamps go out.

## Lighting

### Interior lighting in the front



- ① Left front reading lamp on/off
- ② Rear interior lighting on/off
- ③ Automatic control on/off
- ④ Front interior lighting on/off
- ⑤ Right front reading lamp on/off
- ⑥ Interior lighting
- ⑦ Ambient lighting
- ⑧ Front reading lamps

### Automatic control

- ▶ **Activating:** Press switch . The interior lighting comes on in darkness, when you:
  - unlock the vehicle
  - remove the SmartKey from the starter switch
  - open a door
  - open the tailgate (wagon)

- ▶ **Deactivating:** Press switch .

The interior lighting goes out after a preset time (▷ page 155).

- ❗ If a door remains open, the interior lamps go out automatically after approximately 5 minutes when the SmartKey is removed or in starter switch position **0**.

### Manual control

- ❗ An interior lamp switched on manually does not go out automatically. Leaving an interior lamp switch in the ON position for extended periods of time with the engine turned off could result in a discharged battery.

- ▶ **Switching on/off front interior lighting:** Press switch .

- ▶ **Switching on/off rear interior lighting:** Press switch .

- ▶ **Switching on/off front reading lamps:** Press respective switch .

### Ambient lighting

The brightness of the ambient lighting ⑦ is adjusted via the “Control system” (▷ page 154).

### Interior lighting in the rear

- ❗ An interior lamp switched on manually does not go out automatically. Leaving an interior lamp switch in the ON position for extended periods of time with the engine turned off could result in a discharged battery.

**Vehicles with power tilt/sliding sunroof**

The overhead control panel is located above the rear seat bench.

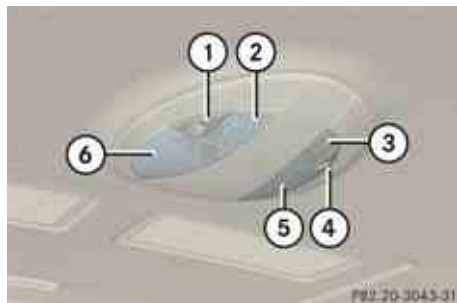

- ① Left rear reading lamp on/off
- ② Left rear reading lamp
- ③ Right rear reading lamp
- ④ Right rear reading lamp on/off
- ⑤ Right rear interior lamp
- ⑥ Left rear interior lamp

► **Switching on/off rear reading lamps:**

Press respective reading lamp switch



**Sedan: Vehicles with panorama roof**

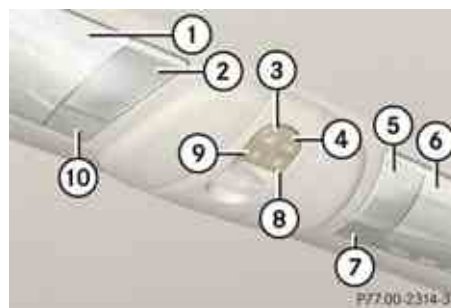

- ① Left ambient lighting
- ② Left rear interior lamp
- ③ Ambient lighting switch, to brighten
- ④ Ambient lighting switch, to dim
- ⑤ Right rear interior lamp
- ⑥ Right ambient lighting
- ⑦ Right rear reading lamp
- ⑧ Right rear reading lamp on/off
- ⑨ Left rear reading lamp on/off
- ⑩ Left rear reading lamp

► **Switching on/off rear reading lamps:**

Press respective reading lamp switch



► **Dim or brighten rear ambient lighting:**

Press ambient lighting switch ③ or ④ until

ambient lighting ① and ⑥ has reached the desired intensity.

You can switch the ambient lighting on and off, using the “Control system” (► page 154).

## Wipers

### Wipers

#### Notes

- ❗ Do not operate the wipers when the windshield/rear window is dry. Dust that accumulates on a windshield/rear window might scratch the glass and/or damage the wiper blades when wiping occurs on a dry windshield/rear window. If it is necessary to operate the wipers in dry weather conditions, always operate the wipers with washer fluid.



Combination switch

- ① Switching on windshield wipers
  - ② Single wipe
- Wiping with washer fluid

- ▶ Switch on the ignition.

### Windshield wipers

#### Switching on/off

0	Windshield wipers off
...	Slow intermittent wiping Rain sensor operation with low sensitivity.
....	Fast intermittent wiping Rain sensor operation with high sensitivity.
—	Slow continuous wiping
≡	Fast continuous wiping

- ▶ Turn the combination switch in direction of arrow ① to the desired position, depending on the intensity of the rain.

#### Intermittent wiping

Only switch on intermittent wiping under wet weather conditions or in the presence of precipitation.

When you select intermittent wiping, the rain sensor is activated. The rain sensor sets a

suitable wiping interval depending on the wetness of the sensor surface automatically.

- ❗ Do not leave windshield wipers on an intermittent setting when the vehicle is taken to an automatic car wash or during windshield cleaning. Windshield wipers will operate in the presence of water sprayed on the windshield, and windshield wipers may be damaged as a result.

- ❗ If you have set intermittent wiping, dirt on the surface of the rain sensor or optical effects may cause the windshield wipers to wipe in an undesired fashion. This could then damage the windshield wiper blades or scratch the windshield. You should therefore switch off the windshield wipers when weather conditions are dry.

- ▶ Turn the combination switch to position ... or ....

After the initial wipe, pauses between wipes are controlled by the rain sensor automatically.

Intermittent wiping is interrupted when the vehicle is at a standstill and a front door is opened. This protects persons getting into or out of the vehicle from being sprayed.

Intermittent wiping will be continued when all doors are closed and



## Wipers

- the automatic transmission is in drive position **D** or reverse gear **R**  
or
- the wiper setting is changed using the combination switch

### Single wipe

- ▶ Press the combination switch briefly in direction of arrow ② to the resistance point.  
The windshield wipers wipe one time without washer fluid.

### Wiping with washer fluid

- ▶ Press the combination switch in direction of arrow ② past the resistance point.  
The windshield wipers operate with washer fluid.
- i** To prevent smears on the windshield or noisy/chattering wiper blades, wipe with washer fluid every now and then even when it is raining.

For information on filling up the washer reservoir, see “Washer system and headlamp cleaning system” (> page 246).

For information on cleaning the headlamps with washer fluid, see “Headlamp cleaning system” (> page 114).

### Rear window wiper/washer



Combination switch

- ① Rear window wiper switch
- ② Wiping rear window with washer fluid
- ③ Intermittent wiping
- ④ Rear window wiper off
- ⑤ Wiping rear window with washer fluid

- ▶ Switch on the ignition.

The rear window wiper engages automatically when the automatic transmission is shifted into reverse gear **R** with the windshield wipers switched on.

- ▶ **Activating intermittent wiping:** Turn rear window wiper switch ① to position ③.
- ▶ **Deactivating intermittent wiping:** Turn rear window wiper switch ① to position ④.
- ▶ **Wiping with washer fluid:** Turn and hold rear window wiper switch ① in position ② or ⑤ until the rear window is clean.

For information on filling up the washer reservoir, see “Washer system and headlamp cleaning system” (> page 246).

### Problems with wipers

**!** If anything blocks the windshield wipers (leaves, snow, etc.), switch them off immediately.



For safety reasons, stop the vehicle in a safe location, and

- - remove the SmartKey from the starter switch  
or
- turn off the engine by pressing the KEYLESS-GO start/stop button and open the driver's door (with the driver's door open, starter switch is in

## Power windows

position **0**, same as with SmartKey removed from starter switch)

- engage the parking brake before attempting to remove any blockage.
- Remove blockage.
- Turn the windshield wipers on again.

If the windshield wipers fail to function at all with the combination switch in position  or ,

- set the combination switch to the next higher wiper speed
- have the windshield wipers checked at the nearest authorized Mercedes-Benz Center

## Power windows

### Opening and closing

The door windows are opened and closed electrically. The switches for all door windows are located on the driver's door control panel. The switches for the respective door windows are located on the front passenger door and on the rear doors.

-  Operating the rear door windows from the rear is not possible when you activate the override switch (▷ page 69).

Vehicles equipped with the PRE-SAFE® system: If the vehicle is in a critical dynamic driving situation, the door windows close until only a small gap remains.

### **Warning!**

When opening or closing the door windows, make sure there is no danger of anyone being harmed by the opening/closing procedure.

The door windows are equipped with the express operation and automatic reversal function. If in express operation mode a door window encounters an obstruction that blocks its path, the automatic reversal

function will stop the door window and open it slightly.

The door windows operate differently when the switch is pressed and held. See the “Closing when a door window is blocked” section in this chapter for details.

The closing of the door windows can be immediately halted by releasing the switch or, if the switch was pulled past the resistance point and released, by either pressing or pulling the respective switch.

If a door window encounters an obstruction that blocks its path in a circumstance where you are closing the door windows by pressing and holding button  on the SmartKey or by pressing and holding the lock button (vehicles with KEYLESS-GO) on an outside door handle, the automatic reversal function will not operate.

Activate the override switch when children are riding in the back seats of the vehicle. The children may otherwise injure themselves, e.g. by becoming trapped in the door window opening.

## Power windows

⚠ **Observe Safety notes, see page 62.**

⚠ **Warning!**

Do not keep any part of your body up against the window pane when opening a window. The downward motion of the pane may pull that part of your body down between the window pane and the door frame and trap it there. If there is a risk of entrapment, release the switch and pull it to close the window.

- ❗ You can also open or close the door windows using the SmartKey, see “Summer opening feature” (▷ page 122) and “Convenience closing feature” (▷ page 123).
- ❗ After switching off the ignition or removing the SmartKey from the starter switch, you can operate the door windows until you open the driver’s or front passenger door. If no door was opened you can operate the door windows for up to 5 minutes.



- ① Left front door window
  - ② Right front door window
  - ③ Right rear door window
  - ④ Left rear door window
- ▶ Switch on the ignition.
  - ▶ **Opening/Closing:** Press or pull and hold switch ① to ④ to the resistance point. The corresponding door window will move downwards or upwards until you release the switch.

- ▶ **Express operation:** Press or pull switch ① to ④ past the resistance point and release. The corresponding door window opens or closes completely.
- ▶ **Stopping during express operation:** Press or pull the respective switch again.

### Closing when a door window is blocked

⚠ **Warning!**

Make sure that nobody can become trapped and be seriously or even fatally injured when closing a door window with greater force or without automatic reversal function.

If the upward movement of a door window is blocked during the closing procedure, the door window will stop and open slightly. However, the door window will exert greater force before reversing than when the door window is closed in express operation. Please exercise caution!

- ▶ Immediately after the door window has stopped because it was blocked, pull the respective switch upwards until the door window is fully closed.

## Power windows

If the door window is blocked again and opens slightly:

- ▶ Immediately after the door window was blocked, pull the respective switch upwards until the door window is fully closed.

### **Warning!**

Pressing and holding the switch to close the door window immediately after it had been blocked two times will cause the door window to close without any reversal function for as long as you hold the switch.

## Synchronizing door windows

The door windows must be synchronized after the battery has been disconnected or if the door windows cannot be fully closed (express operation).

Each door window must be synchronized separately.

- ▶ Close all doors.
- ▶ Switch on the ignition.
- ▶ Pull and hold switch ①, ②, ③ or ④ (▷ page 121) until the respective door window is closed.  
The door window opens again slightly.

- ▶ Pull and hold the respective switch once more immediately until the door window is completely closed.
- ▶ Hold the respective switch for approximately 1 second.  
The door window is synchronized.

## Summer opening feature



If the weather is warm, you can ventilate the vehicle before driving off by simultaneously:

- opening the door windows
- opening the tilt/sliding sunroof
- opening the panorama roof and roller sunblinds
- switching on the seat ventilation for the driver's seat

The summer opening feature can only be activated via the remote control of the SmartKey. The SmartKey must be in close proximity to the driver's outside door handle.



- ▶ Aim transmitter eye of the SmartKey at the driver's outside door handle.

## Vehicles with tilt/sliding sunroof

- ▶ Press and hold button  on the SmartKey until the door windows and the tilt/sliding sunroof have reached the desired position.  
The vehicle unlocks.
- ▶ Release button  on the SmartKey to interrupt the opening procedure.

## Vehicles with panorama roof (sedan)

When roller sunblinds are extended:

- ▶ Press and hold button  on the SmartKey.  
The vehicle unlocks.  
The door windows open and the roller sunblinds begin to retract after approximately 1 second.
- ▶ With the door windows opened and the roller sunblinds fully retracted, press and hold button  on the SmartKey again.  
The tilt/sliding panel opens.
- ▶ Release button  on the SmartKey to interrupt the opening procedure.

When roller sunblinds are retracted:

- ▶ Press and hold button  on the SmartKey.  
The vehicle unlocks.

## Power windows

The door windows and the tilt/sliding panel opens after approximately 1 second.

- ▶ Release button  on the SmartKey to interrupt the opening procedure.

### Convenience closing feature

When locking the vehicle, you can simultaneously close



- the door windows
- the tilt/sliding sunroof
- the panorama roof

Afterward, you can extend the roller sunblinds of the panorama roof.

#### Warning!

When closing the door windows and the tilt/sliding sunroof or panorama roof, make sure there is no danger of anyone being harmed by the closing procedure.

If potential danger exists, proceed as follows:

- Release button  to stop the closing procedure. To open, press and hold button . To continue the closing procedure after making sure that there is no danger of anyone being harmed by the



closing procedure, press and hold button .

Vehicles with KEYLESS-GO:

- Release the lock button on the outside door handle to stop the closing procedure.
- Immediately pull on the same outside door handle and hold firmly. The door windows and the tilt/sliding sunroof or panorama roof will open for as long as the door handle is held but the door not opened.

### With SmartKey

The SmartKey must be in close proximity to the driver's outside door handle.

- ▶ Aim transmitter eye of the SmartKey at the driver's outside door handle.
- ▶ Press and hold button  on the SmartKey until the door windows and the tilt/sliding sunroof or panorama roof are completely closed.
- ▶ Release button  on the SmartKey to interrupt the closing procedure.

#### ▶ Vehicles with panorama roof (sedan):

Press and hold button  on the SmartKey once more.

The roller sunblinds extend.

- ▶ Release button  on the SmartKey to interrupt the extending procedure.

### With KEYLESS-GO

The SmartKey with KEYLESS-GO must be located outside the vehicle within approximately 3 ft (1 m) of a door.

- ▶ Close all doors.
- ▶ Press and hold the lock button on an outside door handle (> page 83) until the door windows and the tilt/sliding sunroof or panorama roof are completely closed.
- ▶ Release the lock button on the outside door handle to interrupt the closing procedure.
- ▶ **Vehicles with panorama roof (sedan):** Press and hold the lock button on an outside door handle once more. The roller sunblinds extend.
- ▶ Release the sensor surface to interrupt the extending procedure.

## Driving and parking

### Driving and parking

#### Safety notes

##### **⚠ Warning!**

Make sure absolutely no objects are obstructing the pedals' range of movement. Keep the driver's footwell clear of all obstacles. If there are any floor mats or carpets in the footwell, make sure the pedals still have sufficient clearance. During sudden driving or braking maneuvers the objects could get caught between the pedals. You could then no longer brake or accelerate. This could lead to accidents and injury.

##### **⚠ Warning!**

With the engine not running, there is no power assistance for the brake and steering systems. In this case, it is important to keep in mind that a considerably higher degree of effort is necessary to brake and steer the vehicle. Adapt your driving accordingly.

### Starting the engine

##### **⚠ Warning!**

Inhalation of exhaust gas is hazardous to your health. All exhaust gas contains carbon monoxide (CO), and inhaling it can cause unconsciousness and possible death.

Do not run the engine in confined areas (such as a garage) which are not properly ventilated. If you think that exhaust gas fumes are entering the vehicle while driving, have the cause determined and corrected immediately. If you must drive under these conditions, drive only with at least one window fully open at all times.

### Automatic transmission



Gearshift pattern for automatic transmission

- P** Park position with gear selector lever lock
- R** Reverse gear
- N** Neutral position
- D** Drive position



For more information, see “Automatic transmission” (▷ page 130).

- ▶ Make sure the automatic transmission is in park position **P**.

### With SmartKey

- ▶ Do not depress the accelerator pedal.

## Driving and parking

- ▶ **Gasoline engine:** Turn the SmartKey in the starter switch to position **3** (▷ page 94) and release it.  
The engine starts automatically.
  - ▶ **Diesel engine:** Turn the SmartKey in the starter switch to position **2** (▷ page 94). Preglow indicator lamp  in the instrument cluster comes on.
  - ▶ As soon as preglow indicator lamp  goes out, turn the SmartKey in the starter switch to position **3** and release it.  
The engine starts automatically.
- i** If the engine is at operating temperature, preglow indicator lamp  may not stay on and you can start the engine without preglowing.

### With KEYLESS-GO

#### **Warning!**

As long as the SmartKey is in your vehicle, the vehicle can be started. Therefore, never leave children unattended in the vehicle, as they could otherwise accidentally start the engine.

When leaving the vehicle, always take the SmartKey with you and lock the vehicle. Do not leave children unattended in the

vehicle, or with access to an unlocked vehicle. A child's unsupervised access to a vehicle could result in an accident and/or serious personal injury.

You can start your vehicle without the SmartKey in the starter switch using the KEYLESS-GO start/stop button on the gear selector lever.

The SmartKey must be located in the vehicle.



KEYLESS-GO start/stop button

- ① USA only
- ② Canada only

- ▶ Depress the brake pedal during the starting procedure.
- ▶ Do not depress the accelerator pedal.

- ▶ **Gasoline engine:** Press the KEYLESS-GO start/stop button once.  
The engine starts automatically.
- ▶ **Diesel engine:** Press the KEYLESS-GO start/stop button once.  
The engine preglows and starts automatically.

**i** If the engine is at operating temperature, the time the engine needs to preglow is reduced.

### Starting difficulties

**!** Remember that extended starting attempts can drain the battery.

If the SmartKey is left in starter switch position **0** for an extended period of time, it can no longer be turned in the starter switch. In this case, the steering is locked.

- ▶ To unlock, remove the SmartKey from the starter switch and reinsert.

**The engine does not start. You can hear the starter.**

There could be a malfunction in the engine electronics or in the fuel supply system.

## Driving and parking

Carry out the following steps:

- ▶ If you are starting the engine with the SmartKey: Turn the SmartKey in the starter switch to position **0** and repeat the starting procedure.
- ▶ If you are starting the engine with KEYLESS-GO: Close any doors that may be open to allow for better detection of the SmartKey.

or

- ▶ Start the engine with the SmartKey as radio signals from another source may be interfering with the KEYLESS-GO function.
- ▶ Repeat the starting procedure.

If the engine does not start after several starting attempts:

- ▶ Contact an authorized Mercedes-Benz Center or call Roadside Assistance.

### **The engine does not start. You cannot hear the starter.**

The battery may not be sufficiently charged.

- ▶ Get a jump start (▷ page 369).

If the engine will not start despite a jump start:

- ▶ Contact an authorized Mercedes-Benz Center or call Roadside Assistance.

The starter has been exposed to excessive temperatures.

- ▶ Let the starter cool for about 2 minutes.
- ▶ Repeat the starting procedure.

If the engine does not start after several starting attempts:

- ▶ Contact an authorized Mercedes-Benz Center or call Roadside Assistance.

### Driving off

#### **Warning!**

On slippery road surfaces, never downshift in order to obtain braking action. This could result in drive wheel slip and reduced vehicle control. Your vehicle's ABS will not prevent this type of loss of control.

-  Do not run cold engine at high engine speeds. Running a cold engine at high engine speeds may shorten the service life of the engine. This is not covered by the Mercedes-Benz Limited Warranty.

E 63 AMG: At engine temperatures below 68°F (20°C), the engine's maximum speed is restricted in order to protect it from damage. Avoid driving your vehicle at full speed when the engine is cold to prevent

premature engine wear and/or diminished comfort.

-  If an acoustic warning sounds and the message **Release Parking Brake** appears in the multifunction display when driving off, you have forgotten to release the parking brake.  
Release the parking brake.

-  Avoid spinning of a drive wheel. This may cause serious damage to the drivetrain which is not covered by the Mercedes-Benz Limited Warranty.

-  Simultaneously depressing the accelerator pedal and applying the brakes reduces engine performance and causes premature brake and drivetrain wear which is not covered by the Mercedes-Benz Limited Warranty.

-  Once the vehicle is in motion, the automatic central locking system engages and the locking knobs in the doors move down.

The automatic door lock feature can be deactivated (▷ page 155).



## Automatic transmission

### Warning!

It is dangerous to shift the automatic transmission out of park position **P** or neutral position **N** if the engine speed is higher than idle speed. If your foot is not firmly on the brake pedal, the vehicle could accelerate quickly forward or in reverse. You could lose control of the vehicle and hit someone or something. Only shift into gear when the engine is idling normally and when your right foot is firmly on the brake pedal.

**!** Only shift the automatic transmission into reverse gear **R** or park position **P** when the vehicle is stopped. Otherwise the automatic transmission could be damaged.

- ▶ Depress the brake pedal.  
The gear selector lever lock is released.
- ▶ Shift the automatic transmission into drive position **D** or reverse gear **R**.
- i** Shifting the automatic transmission out of park position **P** is only possible with the brake pedal depressed.  
Only depressing the brake pedal releases the gear selector lever lock.

- ▶ Wait for the gear selection process to complete before setting the vehicle in motion.
- ▶ Release the brake pedal.
- ▶ If engaged, release the parking brake.
- ▶ Carefully depress the accelerator pedal.

After a cold start, the automatic transmission shifts at a higher engine revolution. This allows the catalytic converter (gasoline engine) or the oxidation catalyst (diesel engine) to reach its operating temperature earlier.

For more information on driving, see “Driving instructions” (▷ page 274).

## Problems while driving

### The engine runs erratically and misfires

- Gasoline engine: An ignition cable may be damaged.
- The engine electronics may not be operating properly.
- Gasoline engine: Unburned gasoline may have entered the catalytic converter and damaged it.

- ▶ Give very little gas.
- ▶ Have the problem checked at an authorized Mercedes-Benz Center as soon as possible.

### The coolant temperature is above 248°F (120°C)

The coolant is too hot and is no longer cooling the engine.

- ▶ Stop the vehicle in a safe location as soon as possible.
- ▶ Turn off the engine immediately.
- ▶ Allow the engine and coolant to cool off.
- ▶ Check the coolant level and add coolant if necessary (▷ page 245).

### In case of accident

If the vehicle is leaking fuel:

- ▶ Do not start the engine under any circumstances.
- ▶ Exit the vehicle at a safe distance from the roadway.
- ▶ Notify local fire and/or police authorities.

If the extent of the damage cannot be determined:

- ▶ Contact an authorized Mercedes-Benz Center or call Roadside Assistance.

## Driving and parking

If no damage on major assemblies, fuel system, and engine mount can be determined:

- ▶ Start the engine in the usual manner.

## Parking

### **Warning!**

Do not park this vehicle in areas where combustible materials such as grass, hay or leaves can come into contact with the hot exhaust system, as these materials could be ignited and cause a vehicle fire.

To reduce the risk of serious personal injury, or damage to the vehicle or the vehicle drivetrain, as a result of vehicle movement, always do the following before turning off the engine and leaving the vehicle:

- Keep right foot on the brake pedal.
- Engage the parking brake.
- Shift the automatic transmission into park position **P**.
- Slowly release the brake pedal.
- When parked on an incline, always turn the front wheels towards the road curb.

- Turn the SmartKey in the starter switch to position **0** and remove the SmartKey from the starter switch, or press the KEYLESS-GO start/stop button.
- Take the SmartKey with you and lock the vehicle when leaving.

### **Warning!**

Vehicles with AIRMATIC: If you have selected the Comfort suspension tuning, the vehicle lowers slightly when you lock it within approximately 60 seconds after turning off the engine. You should therefore make sure that no one is standing near the wheel arches or lying underneath the vehicle when it is being locked. Otherwise, personal injury could result.

Also, make sure your vehicle cannot come into contact with objects, such as a road curb, while lowering. Your vehicle could otherwise be damaged.

## Parking brake

### **Warning!**

Engaging the parking brake while the vehicle is in motion can cause the rear wheels to lock up. You could lose control of

the vehicle and cause an accident. In addition, the vehicle's brake lights do not light up when the parking brake is engaged.

### **Warning!**

When leaving the vehicle, always remove the SmartKey from the starter switch, take it with you, and lock the vehicle. Do not leave children unattended in the vehicle, or with access to an unlocked vehicle. Children could release the parking brake and/or shift the automatic transmission out of park position **P**, either of which could result in an accident and/or serious personal injury.

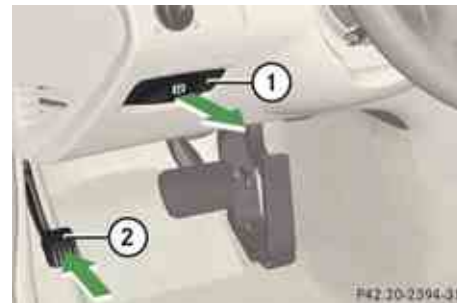

- ① Release handle
- ② Parking brake pedal

- ▶ **Releasing:** Pull on release handle ①.  
When the ignition is switched on or the engine is running, the brake warning lamp **BRAKE** (USA only) or ① (Canada only) in the instrument cluster goes out.
- ▶ **Engaging:** Step firmly on parking brake pedal ②.  
When the engine is running, the brake warning lamp **BRAKE** (USA only) or ① (Canada only) in the instrument cluster comes on.

### Turning off the engine

#### **Warning!**

Do not turn off the engine before the vehicle has come to a complete stop. With the engine not running, there is no power assistance for the brake and steering systems. In this case, it is important to keep in mind that a considerably higher degree of effort is necessary to brake and steer the vehicle.

- ▶ Shift the automatic transmission into park position **P**.
- ▶ Engage the parking brake.

- ① Always engage the parking brake in addition to shifting the automatic transmission into park position **P**.  
When parked on an incline, also turn the front wheels towards the road curb.

### With SmartKey

- ▶ Turn the SmartKey in the starter switch to position **0**.
- ▶ Remove the SmartKey from the starter switch.  
The immobilizer is activated.

The SmartKey can only be removed from the starter switch with the automatic transmission in park position **P**.

### With KEYLESS-GO

- ▶ Press the KEYLESS-GO start/stop button.  
With the driver's door closed, the starter switch is now in position **1**. With the driver's door opened, the starter switch is set to position **0**, same as the SmartKey removed from the starter switch (▷ page 94).

If an acoustic warning sounds, you have tried to turn off the engine with the KEYLESS-GO start/stop button while the automatic transmission was not in park position **P**.

Read and observe messages that may appear in the multifunction display (▷ page 307).

## Automatic transmission

### Automatic transmission

#### Introduction

For information on driving with an automatic transmission, see “Driving and parking” (▷ page 124).

#### **⚠ Warning!**

Make sure absolutely no objects are obstructing the pedals’ range of movement. Keep the driver’s footwell clear of all obstacles. If there are any floor mats or carpets in the footwell, make sure the pedals still have sufficient clearance.

During sudden driving or braking maneuvers the objects could get caught between the pedals. You could then no longer brake or accelerate. This could lead to accidents and injury.

**!** Allow engine to warm up under low load use. Do not place full load on the engine until the operating temperature has been reached.

Avoid spinning of a drive wheel for an extended period when driving off on slippery road surfaces.

This may cause serious damage to the engine and the drivetrain which is not

covered by the Mercedes-Benz Limited Warranty.

**i** During the brief warm-up, transmission upshifting is delayed. This allows the catalytic converter (gasoline engine) or oxidation catalyst (diesel engine) to heat up more quickly to operating temperature.

#### Gear selector lever



Gearshift pattern for automatic transmission

- P** Park position with gear selector lever lock
- R** Reverse gear
- N** Neutral position
- D** Drive position

#### **⚠ Warning!**

It is dangerous to shift the automatic transmission out of park position **P** or neutral position **N** if the engine speed is higher than idle speed. If your foot is not firmly on the brake pedal, the vehicle could accelerate quickly forward or in reverse. You could lose control of the vehicle and hit someone or something. Only shift into gear when the engine is idling normally and when your right foot is firmly on the brake pedal.

**!** Only shift the automatic transmission into reverse gear **R** or park position **P** when the vehicle is stopped. Otherwise the automatic transmission could be damaged.

**i** Shifting the automatic transmission out of park position **P** is only possible with the brake pedal depressed.

Only depressing the brake pedal releases the gear selector lever lock.

**i** The current gear selector lever position corresponds with the current transmission position.

The current transmission position **P**, **R**, **N**, or **D** appears in the multifunction display (▷ page 131).

There are additional indicators on the cover of the shifting gate showing the current gear selector lever position.

The indicators come on when you insert the SmartKey into the starter switch, and go out when you remove the SmartKey from the starter switch.

## Shifting procedure

The automatic transmission selects individual gears automatically, depending on:

- the selected gear range (▷ page 133)
- the selected program mode:
  - C/S** (▷ page 133)
  - or
  - M** (E 63 AMG only) (▷ page 135)
- the position of the accelerator pedal
- the vehicle speed

With drive position **D** selected, you can influence transmission shifting by:

- limiting the gear range
- extending the gear range
- changing the gears manually (E 63 AMG only)

## Transmission positions

The current transmission position appears in the multifunction display.



① Transmission position indicator

## Automatic transmission

	Effect
<b>P</b>	<p><b>Park position</b></p> <p>Shift the automatic transmission into park position <b>P</b> only when the vehicle is stopped. The park position is not intended to serve as a brake when the vehicle is parked. Rather, the driver should always engage the parking brake in addition to shifting the automatic transmission into park position <b>P</b> to secure the vehicle.</p> <p>The SmartKey can only be removed from the starter switch with the gear selector lever in park position <b>P</b>. With the SmartKey removed from the starter switch, the gear selector lever is locked in park position <b>P</b>.</p> <p>If the vehicle's electrical system is malfunctioning, the gear selector lever could remain locked in park position <b>P</b>. To unlock the gear selector lever manually, see "Manually unlocking the gear selector lever" (▷ page 345).</p>
<b>R</b>	<p><b>Reverse gear</b></p>



## Automatic transmission

	Effect
	Shift the automatic transmission into reverse gear <b>R</b> only when the vehicle is stopped.

	Effect
<b>N</b>	<p><b>Neutral position</b></p> <p>No power is transmitted from the engine to the drive axle. When the brakes are released, the vehicle can be moved freely (pushed or towed).</p> <p>To avoid damage to the transmission, never shift the automatic transmission into neutral position <b>N</b> while driving.</p> <p>Exception: If the ESP® is deactivated or malfunctioning, shift the automatic transmission into neutral position <b>N</b> if the vehicle is in danger of skidding.</p> <p><b>!</b> Coasting the vehicle, or driving for any other reason with the automatic transmission in neutral position <b>N</b> can result in transmission damage that is not covered by the Mercedes-Benz Limited Warranty.</p>
<b>D</b>	<b>Drive position</b>

	Effect
	The automatic transmission shifts automatically. All forward gears are available.

### Driving tips

#### Kickdown

Use the kickdown when you want maximum acceleration.

- ▶ Depress the accelerator pedal past the point of resistance. Depending on the engine speed the automatic transmission shifts into a lower gear.

#### Working on the vehicle

##### **Warning!**

When working on the vehicle, engage the parking brake and shift the automatic transmission into park position **P**. Otherwise the vehicle could roll away which could result in an accident and/or serious personal injury.

### Gear ranges

With the automatic transmission in drive position **D** and driving in automatic program mode **C** or **S**, you can limit or extend the gear range, see “One-touch gearshifting” (> page 134).

The current gear range appears in the multifunction display.



① Gear range indicator

	Effect
<b>3</b>	With this selection you can use the braking effect of the engine.
<b>2</b>	Allows the use of engine’s braking power when driving <ul style="list-style-type: none"> <li>• on steep downgrades</li> <li>• in mountainous regions</li> <li>• under extreme operating conditions</li> </ul>
<b>1</b>	For maximum use of engine’s braking effect on very steep or lengthy downgrades.

### Automatic shift program



Program mode selector switch

### Automatic transmission

<b>C</b> Comfort	For comfort driving
<b>S</b> Sport	For standard driving



Program mode selector switch on E 63 AMG

<b>C</b> Comfort	For standard driving
<b>S</b> Sport	For sporty driving
<b>M</b> Manual	For manual gearshifting (> page 135)

## Automatic transmission

The current program mode appears in the multifunction display.



① Program mode indicator

You should only change the program mode when the automatic transmission is in park position **P**.

**i** The last selected automatic program mode (**C** or **S**) is switched on when the engine is restarted.

▶ Press the program mode selector switch repeatedly until the letter of the desired program mode appears in the multifunction display.

Selecting program mode **C** means:

- The vehicle starts out more gentle, both forward and reverse, except when driving off with full throttle.
- Traction and driving stability are improved on icy roads.
- Upshifts occur earlier even when you give more gas. The engine then operates at

lower revolutions and the wheels are less likely to spin.

Selecting program mode **S** means that upshifts occur later.

## One-touch gearshifting

With the automatic transmission in drive position **D** and driving in automatic program mode **C** or **S**, you can limit or extend the gear range using the gear selector lever or the steering wheel gearshift control.

E 63 AMG: For information on using the gear selector lever or the steering wheel gearshift control in manual program mode **M**, see “Manual shift program” (▶ page 135).



Steering wheel gearshift control (example illustration)

- ① Limiting gear range  
Downshift (in manual program mode **M**)
- ② Extending gear range  
Upshift (in manual program mode **M**)

**i** You cannot shift with the steering wheel gearshift control when the automatic transmission is in park position **P**, neutral position **N**, or reverse gear **R**.

## Limiting gear range

### **⚠ Warning!**

On slippery road surfaces, never downshift in order to obtain braking action. This could result in drive wheel slip and reduced



## Automatic transmission

vehicle control. Your vehicle's ABS will not prevent this type of loss of control.

- ▶ Briefly press the gear selector lever to the left in the **D-** direction.

or

- ▶ Briefly pull left gearshift control ①. The automatic transmission will shift into the next lower gear as permitted by the shift program. This action simultaneously limits the gear range of the automatic transmission.

- ❗ To avoid overrevving the engine when downshifting, the automatic transmission will not shift into a lower gear if the engine's maximum speed would be exceeded.

### Extending gear range

- ▶ Briefly press the gear selector lever to the right in the **D+** direction.

or

- ▶ Briefly pull right gearshift control ②. The automatic transmission will shift into the next higher gear as permitted by the shift program. This action simultaneously extends the gear range of the automatic transmission.

- ❗ If you press on the accelerator pedal when the engine has reached the revolution limit of the current gear range, the automatic transmission will upshift beyond any gear range limit selected.

### Canceling gear range limit

- ▶ Press and hold the gear selector lever to the right in the **D+** direction until **D** reappears in the multifunction display.
- or
- ▶ Pull and hold right gearshift control ② until **D** reappears in the multifunction display. The automatic transmission will shift from the current gear range directly into drive position **D**.

### Shifting into optimal gear range

- ▶ Press and hold the gear selector lever to the left in the **D-** direction.
- or
- ▶ Pull and hold left gearshift control ①. The automatic transmission will select the gear range suited for optimal acceleration and deceleration automatically. This will involve shifting down one or more gears.

### Manual shift program

The manual shift program is available on E 63 AMG only.

Manual program mode **M** differs with regard to spontaneity, response time, and shifting smoothness from automatic program mode **S**.

In manual program mode **M**, system-controlled automatic gearshifting is switched off. You need to change the gears by manually upshifting or downshifting using the gear selector lever or the steering wheel gearshift control.



Program mode selector switch

## Automatic transmission

<b>C</b> Comfort	For standard driving
<b>S</b> Sport	For sporty driving
<b>M</b> Manual	For manual gearshifting

The current program mode appears in the multifunction display (▷ page 134).

For information on automatic program mode (**C** or **S**), see “Automatic shift program” (▷ page 133) and “One-touch gearshifting” (▷ page 134).

### Activating manual shift program

- ▶ Press the program mode selector switch repeatedly until **M** appears in the multifunction display. The automatic transmission switches to manual program mode **M**. Automatic shifting is switched off. The gear range is not limited.

You can change the gears manually with drive position **D** selected. You can upshift or downshift through the gears in succession.

- i** Manual program mode **M** will not be stored. When the engine is turned off with manual program mode **M** selected, the automatic transmission will go to

automatic program mode (**C** or **S**) when the engine is restarted.

### Upshifting

**!** In manual program mode **M**, the automatic transmission will not upshift, even if the engine has reached its overrevving range. Shift up into the next gear before the engine has reached its overrevving range. Make absolutely certain that the engine speed does not reach the red marking on the tachometer. Otherwise the engine could be damaged which is not covered by the Mercedes-Benz Limited Warranty.

- ▶ Briefly press the gear selector lever to the right in the **D+** direction.

or

- ▶ Briefly pull right gearshift control ② (▷ page 134).

The automatic transmission shifts into the next higher gear.

### Upshift indicator



- ① Current gear
- ② Upshift indicator

In manual program mode **M**, upshift indicator ② in the multifunction display advises you to upshift before the engine reaches the overspeed range. In addition, symbol **^** may appear instead of manual program mode symbol **M** in the multifunction display. Thus you can drive at the maximum engine speed for each gear without overrevving the engine.

- ▶ Shift the automatic transmission from current gear ① into the next higher gear. The fuel supply will otherwise be interrupted to prevent the engine from overrevving.

### Downshifting

#### **Warning!**

On slippery road surfaces, never downshift in order to obtain braking action. This could result in drive wheel slip and reduced vehicle control. Your vehicle’s ABS will not prevent this type of loss of control.

## Automatic transmission

- ▶ Briefly press the gear selector lever to the left in the **D**- direction.

or

- ▶ Briefly pull left gearshift control ① (> page 134).

The automatic transmission shifts into the next lower gear.

- i** For maximum acceleration, press and hold the gear selector lever to the left in the **D**- direction or pull and hold the left gearshift control. Depending on the engine speed the automatic transmission selects the optimal gear for maximum acceleration.

- i** When you brake or stop, the automatic transmission shifts down into a gear from which you can easily accelerate or take off.

### Kickdown

Using the kickdown when driving in manual program mode **M** is not possible.

### Deactivating manual shift program

- ▶ Press the program mode selector switch repeatedly until **C** or **S** appears in the multifunction display.

or

- ▶ Restart the engine.  
The automatic transmission will go to automatic program mode (**C** or **S**).

Manual program mode **M** is not stored.

### Emergency operation (limp-home mode)

If vehicle acceleration becomes less responsive or sluggish or the automatic transmission no longer shifts, the automatic transmission is most likely operating in limp-home (emergency operation) mode. In this mode only second gear and reverse gear **R** can be selected.

- ▶ Stop the vehicle in a safe location.
- ▶ Shift the automatic transmission into park position **P**.
- ▶ Turn off the engine.
- ▶ Wait at least 10 seconds before restarting.
- ▶ Restart the engine.

- ▶ Shift the automatic transmission into drive position **D** (for second gear) or reverse gear **R**.
- ▶ Have the automatic transmission checked at an authorized Mercedes-Benz Center as soon as possible.

## Instrument cluster

### Instrument cluster

#### Introduction

For a full view illustration of the instrument cluster, see “Instrument cluster” (▷ page 30).

#### **⚠ Warning!**

No messages will be displayed if either the instrument cluster or the multifunction display is inoperative.

As a result, you will not be able to see information about your driving conditions, such as speed or outside temperature, warning/indicator lamps, malfunction/warning messages or the failure of any systems. Driving characteristics may be impaired.

If you must continue to drive, please do so with added caution. Contact an authorized Mercedes-Benz Center as soon as possible.



#### ① Reset button

For information on changing the instrument cluster settings, e.g. the language, see (▷ page 151).

### Activating the instrument cluster

The instrument cluster is activated when you

- open a front door
- switch on the ignition
- press reset button ①
- switch on the exterior lamps

### Adjusting the instrument cluster illumination

**i** The instrument cluster illumination is dimmed or brightened automatically to suit ambient light conditions.

The instrument cluster illumination will also be adjusted automatically when you switch on the vehicle’s exterior lamps.

- ▶ **To brighten illumination:** Turn reset button ① clockwise until the desired level of illumination is reached.
- ▶ **To dim illumination:** Turn reset button ① counterclockwise until the desired level of illumination is reached.

### Coolant temperature indicator

The coolant temperature indicator is located on the right side in the instrument cluster (▷ page 30).

#### **⚠ Warning!**

Driving when your engine is overheated can cause some fluids which may have leaked into the engine compartment to catch fire. You could be seriously burned.

Steam from an overheated engine can cause serious burns which can occur just by opening the engine hood. Stay away from the engine if you see or hear steam coming from it.

Stop the vehicle in a safe location away from other traffic. Turn off the engine, get out of the vehicle and do not stand near the vehicle until the engine has cooled down.

During severe operating conditions, e.g. stop-and-go traffic, the coolant temperature may rise close to 248°F (120°C).

**!** Excessive coolant temperature triggers a warning in the multifunction display and the red coolant temperature warning lamp  in the instrument cluster comes on.

The engine should not be operated with a coolant temperature above 248°F (120°C). Doing so may cause serious engine damage which is not covered by the Mercedes-Benz Limited Warranty.

### Resetting trip odometer

- ▶ Make sure you are viewing the standard display (▷ page 143) in the multifunction display.
- ▶ Press and hold the reset button in the instrument cluster (▷ page 138) until the trip odometer is reset.

### Tachometer

The red marking on the tachometer (▷ page 30) denotes excessive engine speed.

**!** Avoid driving at excessive engine speeds, as it may result in serious engine damage that is not covered by the Mercedes-Benz Limited Warranty.

To help protect the engine, the fuel supply is interrupted if the engine is operated within the red marking.

## Control system

### Introduction

The control system is activated as soon as the starter switch is in position **1** (▷ page 94).

The control system enables you to call up information about your vehicle and to change vehicle settings.

For example, you can use the control system to find out when your vehicle is next due for maintenance service, to set the language for messages in the instrument cluster display, and much more.

### **Warning!**

A driver's attention to the road and traffic conditions must always be his/her primary focus when driving.

For your safety and the safety of others, selecting features through the multifunction steering wheel should only be done by the driver when traffic and road conditions permit it to be done safely.

Bear in mind that at a speed of just 30 mph (approximately 50 km/h), your vehicle is covering a distance of 44 feet (approximately 14 m) every second.







## Control system





The control system relays information to the multifunction display.

### Multifunction steering wheel

The displays in the multifunction display and the settings in the control system are controlled by the buttons on the multifunction steering wheel.



①	Multifunction display
②	Press button  to take a call to dial <sup>7</sup> to redial <sup>7</sup>  to end a call to reject an incoming call
③	Press button  to select submenus in the Settings menu  to set values to operate the RACETIMER <sup>8</sup> to set the volume
④	Press button  to select next or previous menu 

⑤	Press button briefly  to move within a menu  Within <b>Audio/DVD</b> menu to select previous or next track, scene or stored station Within <b>Telephone</b> menu to switch to the phone book and select a name or number
	Press and hold button  Within <b>Audio/DVD</b> menu to select previous or next track with quick search or to select previous or next station in station list or wave band Within <b>Telephone</b> menu to start the quick search in the phone book 

Depending on the selected menu, pressing the buttons on the multifunction steering wheel will alter what appears in the multifunction display.

The information available in the multifunction display is arranged in menus and accompanying functions and submenus.





<sup>7</sup> Function only available in telephone menu.

<sup>8</sup> AMG vehicles only.

## Control system

The individual functions are then found within the relevant menu (radio or CD operations under **Audio/DVD** menu, for example). These functions serve to call up relevant information or to customize the settings for your vehicle.

It is helpful to think of the menus, and the functions within each menu, as being arranged in a circular pattern.

- ▶ Press button  or  repeatedly to pass through each menu one after the other.
- ▶ Press button  or  repeatedly to pass through each function display, one after the other, in the current menu.

In the **Settings** menu, instead of functions, you will find a number of submenus for calling

up and changing settings. For instructions on using these submenus, see “Settings menu” (▷ page 149).

The number of menus available in the system depends on which optional equipment is installed in your vehicle.

## Multifunction display



- ① Outside temperature indicator
- ② Trip odometer
- ③ Automatic transmission program mode indicator
- ④ Main odometer
- ⑤ Transmission position/gear range indicator

For more information on menus displayed in the multifunction display, see “Menus and submenus” (▷ page 142).

## Control system

### Menus and submenus

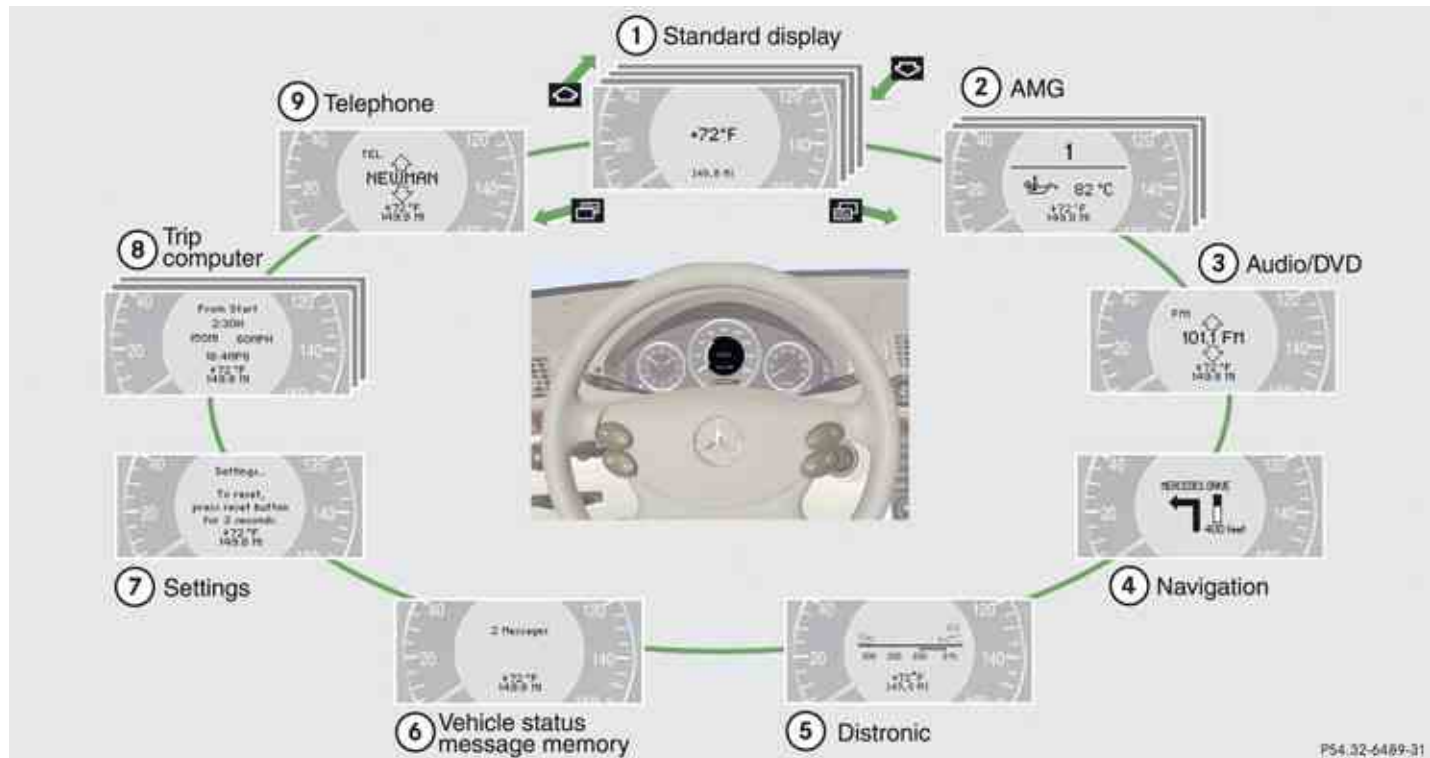

P54.32-6489-31

**i** The headings used in the menu table are designed to facilitate navigation within the

system and are not necessarily identical to those shown in the multifunction display.



The first function displayed in each menu will automatically show you which part of the system you are in.

	Function
①	<b>Standard display</b> menu (▷ page 143)
②	<b>AMG<sup>9</sup></b> menu (▷ page 144)
③	<b>Audio/DVD</b> menu (▷ page 146)
④	<b>Navigation</b> menu (▷ page 148)
⑤	<b>Distronic</b> menu (▷ page 148)
⑥	<b>Vehicle status message memory<sup>10</sup></b> menu (▷ page 148)
⑦	<b>Settings</b> menu (▷ page 149)
⑧	<b>Trip computer</b> menu (▷ page 156)
⑨	<b>Telephone</b> menu (▷ page 158)





### Standard display menu

You can select whether the digital speedometer or the outside temperature appears in the standard display (▷ page 152).



Standard display

- ① Basic display with outside temperature
- ② Trip odometer

- ▶ If you see another display, press button  or  repeatedly until the standard display appears.
- ▶ Press button  or  to select the functions in the **Standard display** menu.

The following functions are available:

- Restarting the Run Flat Indicator (▷ page 257) (Canada only)
- Restarting the TPMS (▷ page 260) (USA only)
- Checking tire inflation pressure with the Advanced TPMS (Canada only) (▷ page 259)
- Calling up digital speedometer or outside temperature (▷ page 143)
- Calling up maintenance service indicator display (▷ page 281)

### Calling up digital speedometer or outside temperature

Depending on the chosen setting for the standard display (▷ page 152) you can call up the other display here.

#### **Warning!**



The outside temperature indicator is not designed to serve as an ice-warning device and is therefore unsuitable for that purpose.

<sup>9</sup> AMG vehicles only.

<sup>10</sup> The vehicle status message memory menu is only displayed if there is a message stored.

## Control system

Indicated temperatures just above the freezing point do not guarantee that the road surface is free of ice. The road may still be icy, especially in wooded areas or on bridges.

- ▶ Press button  or  repeatedly until the digital speedometer or the outside temperature appears in the multifunction display.





- ① Basic display with digital speedometer
- ② Status line display with outside temperature
- ③ Trip odometer

You can select whether the digital speedometer or the outside temperature appears in the status line display (▷ page 152).

## AMG menu

This function is only available in AMG vehicles.

The main screen of the **AMG** menu shows you the gear currently engaged as well as the engine oil temperature.



- ▶ Press button  or  repeatedly until the **AMG** menu appears in the multifunction display.



- ① Gear indicator
- ② Engine oil temperature indicator



The engine oil temperature flashes if the engine oil temperature has not yet reached 80°C. During this time, avoid driving at full engine speed.

If the engine reaches the overspeed range in the manual shift program, the menu will be shown in red. In addition, you will see **UP** next to gear indicator ① as a reminder to upshift.

Use buttons  or  to select the following functions in the **AMG** menu:

- Vehicle supply voltage (▷ page 144)
- RACETIMER (▷ page 145)
- Overall analysis (▷ page 146)
- Lap analysis (▷ page 146)

## Vehicle supply voltage

- ▶ Press button  or  repeatedly until the **AMG** menu appears in the multifunction display.
- ▶ Press button  repeatedly until the vehicle supply voltage appears in the multifunction display.





- ① Gear indicator
- ② Vehicle supply voltage indicator

## RACETIMER

### Warning!

The RACETIMER feature is only for use on roads and in conditions where high speed driving is permitted. Racing on public roads is prohibited under all circumstances and the driver is and must always remain responsible for following posted speed limits.



The RACETIMER allows you to time and save driving stretches.



- ▶ Press button  or  repeatedly until the **AMG** menu appears in the multifunction display.
- ▶ Press button  repeatedly until the RACETIMER appears in the multifunction display.



- ① Gear indicator
- ② RACETIMER
- ③ Lap number

You can start the RACETIMER when the engine is running or the starter switch is in position **2** (▷ page 94).

While the RACETIMER is being displayed, you cannot adjust the audio volume using buttons  or .



- ▶ **Starting:** Press button .
- ▶ **Displaying intermediate time:** Press button  while the timer is running. The intermediate time is shown for 5 seconds.

- ▶ **Stopping:** Press button .

When you stop the vehicle and turn the SmartKey to position **1** (▷ page 94) or, in vehicles with KEYLESS-GO, turn off the engine and do not open the driver's door, the RACETIMER stops timing. Timing is resumed when you switch the ignition back on or restart the engine and then press button .

### Saving lap time and starting a new lap

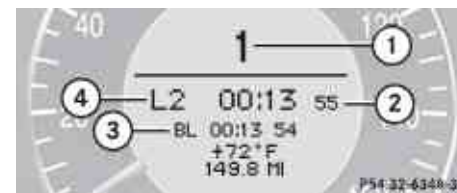

You can save up to nine laps.

- ▶ Press button  while the timer is running. The intermediate time will be shown for 5 seconds.
- ▶ Press button  within 5 seconds. The intermediate time shown will be saved as a lap time. The RACETIMER begins timing the new lap. The new lap begins to be timed as soon as the intermediate time is called up.



- ① Gear indicator
- ② RACETIMER
- ③ Best lap time
- ④ Lap number



### Resetting current lap

- ▶ Press button  while the timer is running. The timer stops.
- ▶ Press button . The lap time is reset to "0".

## Control system



### Deleting all laps

It is not possible to delete a single saved lap. When you turn off the engine, the RACETIMER will be reset to "0" after 30 seconds. All laps are deleted.

- ▶ Press button  while the timer is running.  
The timer stops.
  - ▶ Press the reset button in the instrument cluster twice (▷ page 138).
  - ▶ Press button .
- The timer starts. The saved laps are deleted.

### Overall analysis

This function is only available if you have saved at least one lap and have stopped the RACETIMER.

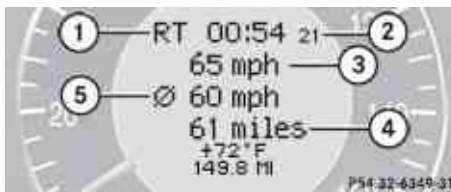

- ▶ Press button  or  repeatedly until the **AMG** menu appears in the multifunction display.
- ▶ Press button  repeatedly until the overall analysis appears in the multifunction display.



- ① Overall analysis of RACETIMER
- ② Overall driving time
- ③ Maximum speed
- ④ Overall distance driven
- ⑤ Average speed

### Lap analysis

This function is only available if you have saved at least two laps and have stopped the RACETIMER.



- ▶ Press button  or  repeatedly until the **AMG** menu appears in the multifunction display.
- ▶ Press button  repeatedly until the lap analysis appears in the multifunction display.

Each lap is shown in its own submenu. The fastest lap is indicated by flashing symbol

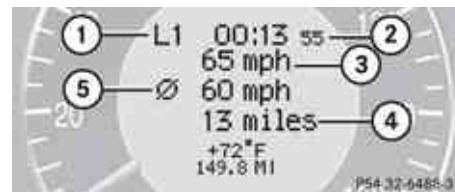
①.



- ① Lap number
- ② Lap time
- ③ Maximum speed during lap
- ④ Lap length
- ⑤ Average speed during lap

- ▶ Press button  or  to see other lap analyses.

### Audio/DVD menu

The functions in the **Audio/DVD** menu operate the audio or video equipment which you have currently switched on.

The following functions are available:

- Selecting radio station (▷ page 147)
- Operating audio devices/audio media (▷ page 147)
- Operating video DVD (▷ page 148)

## Control system



If no audio equipment is currently switched on, the message **AUDIO Off** appears in the multifunction display.

### Selecting radio station

The HD Radio with SIRIUS Satellite Radio is treated as a radio application.

For more information on HD Radio with SIRIUS Satellite Radio, refer to separate COMAND system operating instructions.







Additional optional satellite radio equipment and a subscription to satellite radio service provider are required for satellite radio operation. Contact an authorized Mercedes-Benz Center for details and availability for your vehicle.

- ▶ Switch on the COMAND system and select radio. Refer to separate COMAND system operating instructions.
- ▶ Press button  or  repeatedly until the currently tuned station appears in the multifunction display.



Example illustration for FM radio



- ① Wave band setting
- ② Station frequency

- ▶ **Select next or previous stored station:** Press button  or  briefly to select a stored station.
- ▶ **Select next or previous station in the station list:** Press and hold button  or  to select a station.
- ▶ **Select next or previous station in wave band** (Only if no station list is available): Press and hold button  or  to select a station.

You can only store new stations using the corresponding feature on the radio. Refer to separate COMAND system operating instructions.

You can also operate the radio in the usual manner.





### Operating audio devices/audio media

- ▶ Switch on the COMAND system and select the audio device or audio media. Refer to separate COMAND system operating instructions.
- ▶ Press button  or  repeatedly until the **Audio/DVD** menu appears in the multifunction display.



Example illustration



- ① Disc number
- ② Current track

- ▶ **Selecting previous or next track:** Press button  or  briefly.
- ▶ **Selecting a track from the track list (quick search):** Press and hold button  or .

The current track does not appear during Audio AUX mode operation.

## Control system

### Operating video DVD

- ▶ Switch on the COMAND system and select DVD-Video. Refer to separate COMAND system operating instructions.
- ▶ Press button  or  repeatedly until the **Audio/DVD** menu appears in the multifunction display.

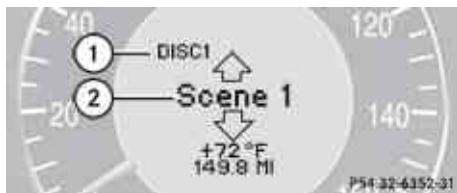



- ① Disc number
- ② Current scene

- ▶ Press button  or  to select a scene.

### Navigation menu

The **Navigation** menu contains the functions needed to operate your navigation system.

- ▶ Press button  or  repeatedly until the **Navigation** menu appears in the multifunction display.

The message shown in the multifunction display depends on the status of the navigation system:

- With the COMAND system switched off, the message **NAVI Off** appears in the multifunction display.
- With the COMAND system switched on but route guidance not activated, the direction of travel and, if applicable, the name of the street currently traveled to appear in the multifunction display.
- With the COMAND system switched on and route guidance activated, the direction of travel and maneuver instructions appear in the multifunction display.

Please refer to separate COMAND system operating instructions for instructions on how to activate the route guidance system.

### Distronic menu

Use the **Distronic** menu to display the current settings for your Distronic system. The information shown in the multifunction display depends on whether the Distronic system is activated or deactivated.

Please refer to the “Driving systems” section of this manual (▷ page 162) for instructions on how to activate Distronic.

### Vehicle status message memory menu



Use the **Vehicle status message memory** menu to scan malfunction and warning messages that may be stored in the memory. Such messages appear in the multifunction display and are based on conditions or system status the vehicle’s system has recorded.

The **Vehicle status message memory** menu only appears if messages have been stored.



#### **Warning!**

Malfunction and warning messages are only indicated for certain systems and are intentionally not very detailed. The malfunction and warning messages are simply a reminder with respect to the

operation of certain systems. They do not replace the owner's and/or driver's responsibility to maintain the vehicle's operating safety. Have all required maintenance and safety checks performed on the vehicle. Bring the vehicle to an authorized Mercedes-Benz Center to address the malfunction and warning messages.

- ▶ Press button  or  repeatedly until the **Vehicle status message memory** menu appears in the multifunction display. If conditions have occurred causing status messages to be recorded, the number of messages appears in the multifunction display.



- ▶ Press button  or . The stored messages will now be displayed in the order in which they have occurred.

For malfunction and warning messages, see “Vehicle status messages in the multifunction display” (▷ page 295).

Should the vehicle's system record any conditions while driving, the number of messages will reappear in the multifunction display when the SmartKey in the starter switch is turned to position **0** or removed from the starter switch. With KEYLESS-GO, the number of messages will reappear when you turn off the engine by pressing the KEYLESS-GO start/stop button and open the driver's door.

Except for high-priority messages, the vehicle status message memory will be cleared when you switch off the ignition.

## Settings menu

### Introduction

In the Settings menu there are two functions: The function To reset, press reset button for 3 seconds., with which you can reset all the settings to the original factory settings and a collection of submenus with which you can make individual settings for your vehicle.



The following settings and submenus are available in the Settings menu:

- Resetting to factory settings (▷ page 149)
- Submenus in the Settings menu (▷ page 150)
- Instrument cluster submenu (▷ page 151)
- Time/Date submenu (▷ page 152)
- Lighting submenu (▷ page 153)
- Vehicle submenu (▷ page 155)
- Convenience submenu (▷ page 156)

### Resetting to factory settings

You can reset the functions of all submenus to the factory settings.

For safety reasons, the function Headlamp Mode in the Lighting submenu cannot be reset while driving.

- ▶ Press button  or  repeatedly until the Settings menu appears in the multifunction display.

## Control system





▶ Press the reset button in the instrument cluster for approximately 3 seconds. The request to press the reset button once more to confirm appears in the multifunction display.

▶ Press the reset button once more. The functions of all the submenus will be reset to factory settings.

The settings you have changed will not be reset unless you confirm the action by pressing the reset button a second time. After approximately 5 seconds, the Settings menu reappears in the multifunction display.









### Submenus in the Settings menu

▶ Press button  or  repeatedly until the Settings menu appears in the multifunction display.

▶ Press button . The collection of the submenus appears in the multifunction display. There are more

submenus than can be simultaneously displayed.



- ▶ Press button . The selection marker moves to the next submenu.
- ▶ Scroll down with button , scroll up with button .
- ▶ With the selection marker on the desired submenu, use button  to access the individual functions within that submenu.
- ▶ Once within the submenu, use button  to move to the next function or button  to move to the previous function within that submenu.
- ▶ Use button  or  to change the settings of the respective function.

The following lists show what settings can be changed within the various menus. Detailed instructions on making individual settings can be found on the following pages.

### Instrument cluster submenu

- Selecting speedometer display mode (▷ page 151)
- Selecting language (▷ page 151)
- Selecting display (speed or outside temperature) for status line (▷ page 152)
- Selecting display (speed or outside temperature) for standard display (▷ page 152)

### Time/Date submenu

- Setting the time (▷ page 152)
- Setting the date (▷ page 153)

### Lighting submenu

- Setting daytime running lamp mode (USA only) (▷ page 153)
- Setting locator lighting (▷ page 154)
- Setting ambient lighting (▷ page 154)
- Setting night security illumination (Headlamps delayed shut-off feature) (▷ page 154)
- Setting interior lighting delayed shut-off (▷ page 155)



### Vehicle submenu

- Setting automatic central locking (▷ page 155)

### Convenience submenu

- Activating easy-entry/exit feature (▷ page 156)



### Instrument cluster submenu

Access the Instr. Cluster submenu via the Settings menu. Use the Instr. Cluster submenu to change the instrument cluster display settings.

The following functions are available:

- Selecting speedometer display mode (▷ page 151)
- Selecting language (▷ page 151)
- Selecting display (speed or outside temperature) for status line (▷ page 152)
- Selecting display (speed or outside temperature) for standard display (▷ page 152)

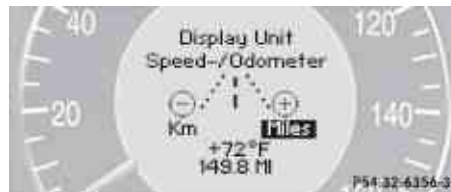

### Selecting speedometer display mode

- ▶ Move the selection marker with button **+** or **-** to the Instr. Cluster submenu.
- ▶ Press button  or  repeatedly until the message Display Unit Speed-/Odometer appears in the multifunction display. The selection marker is on the current setting.



- ▶ Press button **+** or **-** to set speedometer unit to Km or Miles.

### Selecting language

- ▶ Move the selection marker with button **+** or **-** to the Instr. Cluster submenu.
- ▶ Press button  or  repeatedly until the message Language appears in the multifunction display. The selection marker is on the current setting.



- ▶ Press button **+** or **-** to select the language to be used for the multifunction display messages.

## Control system

### Selecting display (speed or outside temperature) for status line

- ▶ Move the selection marker with button **+** or **-** to the Instr. Cluster submenu.
- ▶ Press button **↕** or **↴** repeatedly until the message **Status Line Display** appears in the multifunction display. The selection marker is on the current setting.



- ▶ Press button **+** or **-** to select the status line to **Speed** or **Outside Temp.**. You will see the status line display when you have called up a different display from the standard display.

### Selecting display (speed or outside temperature) for standard display

- ▶ Move the selection marker with button **+** or **-** to the Instr. Cluster submenu.
- ▶ Press button **↕** or **↴** repeatedly until the message **Basic Display** appears in the multifunction display. The selection marker is on the current setting.



- ▶ Press button **+** or **-** to select the display shown in the standard display. The other display now appears in the **Standard display** menu (▶ page 143).

### Time/Date submenu

Access the Time/Date submenu via the Settings menu. Use the Time/Date submenu to change the time and date display settings.

The following functions are available:

- Setting the time (▶ page 152)
- Setting the date (▶ page 153)

### Setting the time

This function is only available if your vehicle is not equipped with navigation module.

- ▶ Move the selection marker with button **+** or **-** to the Time/Date submenu.
- ▶ Press button **↕** or **↴** repeatedly until the message **Time - Hours Press R To Confirm** or **Time - Minute(s) Press R To Confirm** appears in the multifunction display. The selection marker is on the current setting.



Example illustration for setting the hour

- ▶ Press button **+** or **-** to set the hours or minute(s).
- ▶ Press the reset button to confirm.

### Setting the date

This function is only available if your vehicle is not equipped with navigation module.

- ▶ Move the selection marker with button **+** or **-** to the Time/Date submenu.
  - ▶ Press button **↕** or **↓** repeatedly until the message **Set Date Month**, **Set Date Day**, or **Set Date Year** appears in the multifunction display.
- The selection marker is on the current setting.



Example illustration for setting the month

- ▶ Press button **+** or **-** to set the month, day, or year.

### Lighting submenu

Access the Lighting submenu via the Settings menu. Use the Lighting submenu to change the lamp and lighting settings on your vehicle.

The following functions are available:

- Setting daytime running lamp mode (USA only) (▷ page 153)
- Setting locator lighting (▷ page 154)
- Setting ambient lighting (▷ page 154)
- Setting night security illumination (▷ page 154)
- Setting interior lighting delayed shut-off (▷ page 155)

### Setting daytime running lamp mode (USA only)

- ▶ Move the selection marker with button **+** or **-** to the Lighting submenu.
  - ▶ Press button **↕** or **↓** repeatedly until the message **Headlamp Mode** appears in the multifunction display.
- The selection marker is on the current setting.

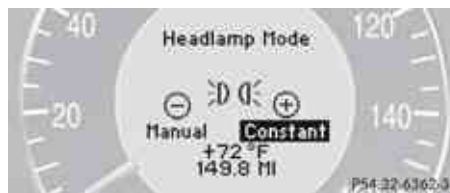

- ▶ Press button **+** or **-** to select manual operation (Manual) or daytime running lamp mode (Constant).

With daytime running lamp mode activated and the exterior lamp switch in position **0** or **AUTO**, the low-beam headlamps are switched on when the engine is running.

In low ambient light conditions the following lamps will come on additionally:

- Parking lamps
- Tail lamps
- License plate lamps
- Side marker lamps

For more information on the daytime running lamp mode, see "Lighting" (▷ page 112).

For safety reasons, resetting all the functions of all submenus to the factory settings while driving (▷ page 149) will not deactivate the daytime running lamp mode.

The following message appears in the multifunction display:

Lighting - Cannot be completely reset to factory settings while driving.

## Control system





### Setting locator lighting

With the locator lighting feature activated and the exterior lamp switch in position **AUTO**, the following lamps will come on during darkness when the vehicle is unlocked using button  on the SmartKey:



- Parking lamps
- Tail lamps
- License plate lamps
- Side marker lamps
- Front fog lamps

The locator lighting goes out when the driver's door is opened.

If you do not open the driver's door after unlocking the vehicle with the SmartKey, the lamps will go out automatically after approximately 40 seconds.





- ▶ Move the selection marker with button  or  to the Lighting submenu.
- ▶ Press button  or  repeatedly until the message Surround Light Function appears in the multifunction display. The selection marker is on the current setting.





- ▶ Press button  or  to switch the locator lighting function On or Off.
- ▶ Turn the exterior lamp switch to position **AUTO** when exiting the vehicle. The locator lighting feature is activated.

### Setting ambient lighting

Use this function to adjust the brightness of the ambient lighting.

- ▶ Move the selection marker with button  or  to the Lighting submenu.
- ▶ Press button  or  repeatedly until the message Ambient Light Level appears in the multifunction display. The selection marker is on the current setting.



- ▶ Press button  or  to select the desired brightness of the ambient lighting. The setting 1 represents the darkest level and setting 5 the brightest level. The ambient light is switched off at setting 0.

### Setting night security illumination (Headlamps delayed shut-off feature)

Use this function to set whether you would like the exterior lamps to remain on for 15 seconds during darkness after exiting the vehicle and closing all doors.

With the headlamps delayed shut-off feature activated and the exterior lamp switch in position **AUTO** before the engine is turned off, the following lamps will come on when the engine is turned off:

- Parking lamps
- Tail lamps
- License plate lamps

## Control system

- Side marker lamps
- Front fog lamps

If, after turning off the engine, you do not open a door or do not close an opened door, the lamps will automatically go out after 60 seconds.

- ▶ Move the selection marker with button **+** or **-** to the Lighting submenu.
- ▶ Press button **↕** or **↘** repeatedly until the message Headlamps Delayed Shut-off appears in the multifunction display. The selection marker is on the current setting.



- ▶ Press button **+** or **-** to switch the headlamps delayed shut-off feature On or Off.
- ▶ Turn the exterior lamp switch to position **AUTO** before turning off the engine. The headlamps delayed shut-off feature is activated.

You can temporarily deactivate the headlamps delayed shut-off feature:

- ▶ Before exiting the vehicle, turn the SmartKey in the starter switch to position **0**.
- ▶ Then turn it to position **2** and back to position **0**. The headlamps delayed shut-off feature is deactivated. It will reactivate as soon as you start the engine.

### Setting interior lighting delayed shut-off

Use this function to set whether you would like the interior lighting to remain on for 10 seconds during darkness after you have removed the SmartKey from the starter switch.

- ▶ Move the selection marker with button **+** or **-** to the Lighting submenu.
- ▶ Press button **↕** or **↘** repeatedly until the message Interior Lighting Delayed Shut-off appears in the multifunction display. The selection marker is on the current setting.

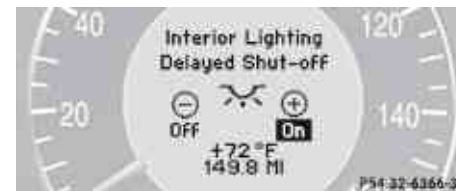

- ▶ Press button **+** or **-** to switch the interior lighting delayed shut-off feature On or Off.

### Vehicle submenu

Access the Vehicle submenu via the Settings menu. Use the Vehicle submenu to set the automatic central locking.

### Setting automatic central locking

Use this function to activate or deactivate the automatic central locking. With the automatic central locking system activated, the vehicle is centrally locked at a vehicle speed of approximately 9 mph (15 km/h).

## Control system

- ▶ Move the selection marker with button **+** or **-** to the Vehicle submenu.
- ▶ Press button **↕** or **↕** repeatedly until the message Automatic Door Locking appears in the multifunction display. The selection marker is on the current setting.



- ▶ Press button **+** or **-** to switch the automatic central locking On or Off.

### Convenience submenu

Access the Convenience submenu via the Settings menu. Use the Convenience submenu to activate the easy-entry/exit feature.

#### Activating easy-entry/exit feature

Use this function to activate and deactivate the easy-entry/exit feature (▷ page 106).

#### **⚠ Warning!**

You must make sure no one can become trapped or injured by the moving steering wheel when the easy-entry/exit feature is activated.

To stop steering wheel movement, move steering wheel adjustment stalk or press one of the memory position buttons.

Do not leave children unattended in the vehicle, or with access to an unlocked vehicle. Children could open the driver's door and unintentionally activate the easy-entry/exit feature, which could result in an accident and/or serious personal injury.

- ▶ Move the selection marker with button **+** or **-** to the Convenience submenu.
- ▶ Press button **↕** or **↕** repeatedly until the message Easy-entry Function appears in the multifunction display. The selection marker is on the current setting.

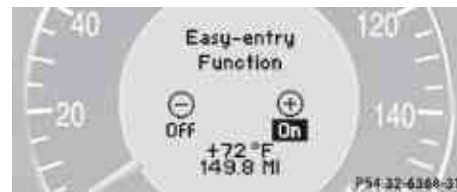

- ▶ Press button **+** or **-** to switch the easy-entry feature On or Off.





### Trip computer menu

Use the **Trip computer** menu to call up statistical data on your vehicle.

The following information is available:

- Fuel consumption statistics since start (▷ page 157)
- Fuel consumption statistics since last reset (▷ page 157)
- Resetting fuel consumption statistics (▷ page 157)
- Distance to empty (▷ page 157)

### Fuel consumption statistics since start





- ▶ Press button  or  repeatedly until the first function of the **Trip computer** menu appears in the multifunction display.
- ▶ Press button  or  repeatedly until the message From Start appears in the multifunction display.



- ① Distance driven since start
- ② Time elapsed since start
- ③ Average speed since start
- ④ Average fuel consumption since start

All statistics stored since the last engine start will be reset approximately 4 hours after the SmartKey in the starter switch is turned to position **0** or removed from the starter switch. Resetting will not occur if you turn the SmartKey back to position **1** or **2** within this time period.





### Fuel consumption statistics since last reset

- ▶ Press button  or  repeatedly until the first function of the **Trip computer** menu appears in the multifunction display.
- ▶ Press button  or  repeatedly until the message From Reset appears in the multifunction display.







- ① Distance driven since last reset
- ② Time elapsed since last reset
- ③ Average speed since last reset
- ④ Average fuel consumption since last reset

### Resetting fuel consumption statistics

- ▶ Press button  or  repeatedly until the first function of the **Trip computer** menu appears in the multifunction display.
- ▶ Press button  or  repeatedly until the reading that you want to reset appears in the multifunction display.
- ▶ Press and hold the reset button in the instrument cluster until the respective values are reset to 0.

The fuel consumption statistics reset automatically to 0 after 99 999 miles or 9 999 hours, whichever occurs first.

### Distance to empty

- ▶ Press button  or  repeatedly until the first function of the **Trip computer** menu appears in the multifunction display.
- ▶ Press button  or  repeatedly until the message Range: appears in the multifunction display. The calculated remaining driving range based on the current fuel tank level appears in the multifunction display. If only very little fuel is left in the tank, a vehicle at the fuel pump  appears instead of the remaining driving range.

## Control system



### Telephone menu

#### **Warning!**



A driver's attention to the road must always be his/her primary focus when driving. For your safety and the safety of others, we recommend that you pull over to a safe location and stop before placing or taking a telephone call. If you choose to use the telephone while driving, please use the hands-free device and only use the telephone when weather, road and traffic conditions permit.

Some jurisdictions prohibit the driver from using a mobile phone while driving a vehicle.

Bear in mind that at a speed of just 30 mph (approximately 50 km/h), your vehicle is covering a distance of 44 feet (approximately 14 m) every second.

Never operate radio transmitters equipped with a built-in or attached antenna (i.e. without being connected to an external antenna) from inside the vehicle while the engine is running. Doing so could lead to a malfunction of the vehicle's electronic system, possibly resulting in an accident and/or personal injury.

You can connect your telephone to the COMAND system via Bluetooth®, see separate COMAND system operating instructions.

- ▶ Switch on the COMAND system.  
Refer to separate COMAND system operating instructions.
- ▶ Press button  or  repeatedly until the message TEL appears in the multifunction display.  
One of the following messages will appear in the multifunction display:
  - No Service: No network is available.
  - Bluetooth Ready: The telephone has not been connected to the COMAND system via Bluetooth® yet.

- ▶ Connect the telephone to the COMAND system via Bluetooth®.

- Ready or name of the network provider (if available): The telephone has found a network and is ready for use. You can operate it using the control system.

### Answering a call

When your telephone is ready to receive calls, you can answer a call at any time. In the multifunction display you will then see the following message, or if available, the caller ID (number or name):



- ▶ Press button .  
You have answered the call.

### Ending a call or rejecting an incoming call





- ▶ Press button .





## Control system

**Dialing a number from the phone book**



When your telephone is ready to receive calls, you may select and dial a number from the phone book at any time.

- ▶ Press button  or  repeatedly until the message TEL appears in the multifunction display.
- ▶ Press button  or  repeatedly until the desired name appears in the multifunction display.

If you press and hold button  or  for longer than 1 second, the system scrolls rapidly through the list of names until you release the button again. The stored names are displayed in ascending or descending alphabetical order.









- ① Selected name from the phone book

- ▶ Press button . The control system dials the selected phone number. If the connection is successful and this feature is supported by your network provider, the name of the party (if stored in your phone book) you are calling will appear in the multifunction display. The control system stores the dialed number in the redial memory.
- or
- ▶ Press button  if you do not want to make the call.

**Redialing**

The control system stores the most recently dialed phone numbers. This eliminates the need to search through your entire phone book.

- ▶ Press button  or  repeatedly until the message TEL appears in the multifunction display.
- ▶ Press button . The first number in the redial memory appears in the multifunction display.
- ▶ Press button  or  repeatedly until the desired number or name appears in the multifunction display.
- ▶ Press button . The control system dials the selected phone number.

## Driving systems

### Driving systems

#### Introduction

This section describes the following driving systems of your vehicle:

- Cruise control and Distronic
- Distance warning function is only available with Distronic
- AIRMATIC DC
- All-wheel drive (4MATIC)
- Parktronic system (sedan)

The ABS, Adaptive Brake, BAS, EBP and ESP® driving safety systems are described in the “Safety and security” section (▷ page 70).

### Cruise control

The cruise control automatically maintains the speed you set for your vehicle.

The use of the cruise control is recommended for driving at a constant speed for extended periods of time.

The currently set speed or last set speed (“Resume” function) appears in the multifunction display for approximately 5 seconds. The corresponding cruise control speed segments from the selected speed to the vehicle maximum speed in the multifunction display are illuminated.

#### **Warning!**

The cruise control is a convenience system designed to assist the driver during vehicle operation. The driver is and must always remain responsible for the vehicle’s speed and for safe brake operation.

Only use the cruise control if the road, traffic, and weather conditions make it advisable to travel at a constant speed.

- The use of the cruise control can be dangerous on winding roads or in heavy

traffic because conditions do not allow safe driving at a constant speed.

- The use of the cruise control can be dangerous on slippery roads. Rapid changes in tire traction can result in wheel spin and loss of control.
- Deactivate the cruise control when driving in fog.

The “Resume” function should only be operated if the driver is fully aware of the previously set speed and wishes to resume this particular preset speed.

#### **Warning!**

The cruise control brakes automatically so that the set speed is not exceeded.

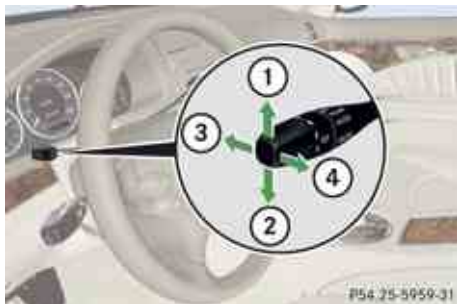

- ① Setting current or higher speed
- ② Setting current or lower speed
- ③ Canceling the cruise control
- ④ Activating the cruise control or resuming to last set speed

### Activating cruise control

You can activate the cruise control at a vehicle speed above 20 mph (30 km/h).  
You cannot activate the cruise control:

- when you brake
- when you have engaged the parking brake

- when the automatic transmission is in park position **P**, reverse gear **R**, or neutral position **N**
- the ESP<sup>®</sup> is switched off or has switched off due to a malfunction

The vehicle speed displayed in the speedometer can briefly vary from the speed setting for the cruise control system.

### Setting current speed

- ▶ Accelerate or decelerate to the desired speed.
- ▶ Briefly lift the cruise control lever in direction of arrow ① or press in direction of arrow ②.
- ▶ Remove your foot from the accelerator pedal.

- ① On uphill grades, the cruise control may not be able to maintain the set speed. Once the grade eases, the set speed will be resumed.

On downhill grades, the cruise control maintains the set speed by braking with the vehicle's brake system. In addition, on longer downhill grades the automatic transmission will downshift automatically.

### Canceling cruise control

- ▶ Depress the brake pedal.

or

- ▶ Briefly push the cruise control lever in direction of arrow ③.

The last set speed is stored for later use.

The last stored speed is deleted from memory when the engine is turned off.

The cruise control switches off automatically when you depress the brake pedal or you engage the parking brake. In this case, the cruise control speed segments in the multifunction display will go out.

The cruise control also switches off automatically when

- the vehicle speed falls below 20 mph (30 km/h)
- the ESP<sup>®</sup> is in operation
- the ESP<sup>®</sup> is switched off with the ESP<sup>®</sup> switch
- the ESP<sup>®</sup> has switched off due to a malfunction
- you shift the automatic transmission into neutral position **N** while driving

The cruise control speed segments in the multifunction display goes out and an



## Driving systems

acoustic warning will sound. Observe additional messages in the multifunction display that may appear.

Depressing the accelerator pedal does not deactivate the cruise control. After a brief acceleration (e.g. for passing), the cruise control will resume the last set speed.

### Changing the set speed

#### **Warning!**

Keep in mind that it may take a brief moment until the vehicle has made the necessary adjustments.

Increase or decrease the set vehicle speed to a value that the prevailing road conditions and legal speed limits permit. Otherwise, sudden and unexpected acceleration or deceleration of the vehicle could cause an accident and/or serious injury to you and others.

When you use the cruise control lever to decelerate, the brake system will brake the vehicle automatically if the engine's braking power does not brake the vehicle sufficiently.

- ▶ Lift the cruise control lever in direction of arrow ① and hold it up to increase, or press the cruise control lever in direction of arrow

② and hold it down to decrease, until the desired speed is reached.

- ▶ Release the cruise control lever. The new speed is set and the vehicle will accelerate or decelerate.

### Fine adjustment in 1 mph (Canada: 1 km/h) increments

- ▶ Briefly tip the cruise control lever in direction of arrow ① to increase or in direction of arrow ② to decrease.

### Resume last stored speed

#### **Warning!**

The set speed stored in memory should only be set again if prevailing road conditions and legal speed limits permit. Possible acceleration or deceleration differences arising from returning to the preset speed could cause an accident and/or serious injury to you and others.

- ▶ Briefly pull the cruise control lever in direction of arrow ④. If no speed is stored, the current speed is set and stored.
- ▶ Remove your foot from the accelerator pedal.

The last stored speed is deleted from memory when the engine is turned off.

## Distronic

### Safety notes

The Distronic is available on the E 63 AMG only.

When activated, the Distronic adaptive cruise control increases the driving convenience afforded by the cruise control while traveling on expressways and other major roadways.

- If the Distronic distance sensor detects a slower moving vehicle directly ahead, your vehicle speed will be reduced so that you follow that vehicle at your preset following distance.
- If there is no vehicle directly ahead of you, the Distronic will function in the same way as standard cruise control (▷ page 160).

#### **Warning!**

The Distronic is a convenience system. Its speed adjustment reduction capability is intended to make cruise control more effective and usable when traffic speeds vary. It is not however, intended to, nor does it, replace the need for extreme care.

The responsibility for the vehicle's speed, distance to the preceding vehicle and, most importantly, brake operation to ensure a safe stopping distance, always remains with the driver.

Complex driving situations are not always fully recognized by the DISTRONIC. This could result in wrong or missing distance warnings.

### **Warning!**

The DISTRONIC adaptive cruise control is not a substitute for active driving involvement. It does not react to pedestrians or on stationary objects, nor does it recognize or predict the lane curvature or the movement of preceding vehicles.

The DISTRONIC can only apply 20% of the maximum braking power of the vehicle.

It is the driver's responsibility at all times to be attentive to the road, weather and traffic conditions. Additionally, the driver must provide the steering, braking and other driving inputs necessary to remain in control of the vehicle.

High-frequency sources such as toll stations, speed measuring systems etc. can cause the DISTRONIC system to malfunction.

### **Warning!**

The DISTRONIC requires familiarity with its operational characteristics. We strongly recommend that you review the following information carefully before operating the system.

### **Warning!**

The DISTRONIC cannot take road and traffic conditions into account. Only use the DISTRONIC if the road, weather and traffic conditions make it advisable to travel at a constant speed.

### **Warning!**

Use of the DISTRONIC can be dangerous on slippery roads. Rapid changes in tire traction can result in wheel spin and loss of control.

The DISTRONIC does not function in adverse sight and distance conditions. Do not use the DISTRONIC during conditions of fog, heavy rain, snow or sleet.

### **Warning!**

The DISTRONIC cannot take weather conditions into account. Switch off the DISTRONIC or do not switch it on if:

- roads are slippery or covered with snow or ice. The wheels could lose traction while braking or accelerating, and the vehicle could skid.
- the DISTRONIC system sensor cover is dirty or visibility is diminished due to snow, rain or fog, for example. The distance control system functionality could be impaired.

Always pay attention to surrounding traffic conditions even while the DISTRONIC is switched on. Otherwise, you may not be able to recognize dangerous situations until it is too late. This could cause an accident in which you and/or others could be injured.

### **Warning!**

The "Resume" function should only be operated if the driver is fully aware of the previously set speed and wishes to resume this particular preset speed.

## Driving systems

### **⚠ Warning!**

Close attention to road and traffic conditions is imperative at all times, regardless of whether or not the Distronic is activated.

Use of the Distronic can be dangerous on winding roads or in heavy traffic because conditions do not allow safe driving at a constant speed.

The Distronic will not react to stationary objects in the roadway (e.g. a stopped vehicle in a traffic jam or a disabled vehicle). The Distronic will also not respond to oncoming vehicles.

Switch off the Distronic:

- when changing from the left to the right lane if vehicles are moving more slowly in the left lane
- when entering a turn lane or highway off ramp
- in complex driving situations, such as in highway construction zones

In these situations, the Distronic will continue to maintain the set speed unless deactivated.

The Distronic is designed and intended only to maintain a set speed and keep a set distance from moving objects in front of it.

### **i USA only:**

This device has been approved by the FCC as a “Vehicular Radar System”. The radar sensor is intended for use in an automotive radar system only. Removal, tampering, or altering of the device will void any warranties, and is not permitted by the FCC. Do not tamper with, alter, or use in any non-approved way.

Any unauthorized modification to this device could void the user’s authority to operate the equipment.

### **i Canada only:**

This device complies with RSS-210 of Industry Canada. Operation is subject to the following two conditions:

1. This device may not cause interference, and
2. this device must accept any interference received, including interference that may cause undesired operation of the device.

Removal, tampering, or altering of the device will void any warranties, and is not permitted. Do not tamper with, alter, or use in any non-approved way.

Any unauthorized modification to this device could void the user’s authority to operate the equipment.

## Distronic displays in the speedometer



### **① Set speed**

If the Distronic is activated, one or two cruise control speed segments come on around the set speed.

The vehicle speed displayed on the speedometer can briefly vary from the speed setting on the Distronic system.



- ① Set speed
- ② Cruise control speed segments
- ③ Speed of the vehicle ahead

If the DISTRONIC detects a vehicle directly ahead, the cruise control speed segments ② appear in the speedometer. These segments represent the difference between the set speed of your vehicle ① and the speed of the preceding vehicle ③.

If the DISTRONIC calculates that there is a danger of collision, the distance warning lamp  in the instrument cluster comes on and an intermittent warning sounds.

- ▶ Immediately apply the brakes to avoid a collision.  
Under no circumstances should the driver await the intermittent warning sound before braking.

The intermittent warning sound ceases and the distance warning lamp  goes out when the necessary distance to the vehicle ahead is established again.

### **Warning!**

An intermittent warning sounds and the distance warning lamp  in the instrument cluster is illuminated if the DISTRONIC system calculates that the distance to the vehicle ahead and your vehicle's current speed indicate that the DISTRONIC will not be capable of slowing the vehicle sufficiently to maintain the preset following distance, which creates a danger of a collision.

Immediately brake the vehicle to increase your distance to the preceding vehicle. The warning sound is intended as a final caution in which you should intercede with your own braking inputs to avoid a potentially dangerous situation. Do not wait for the operation of the warning signal to intercede with your own braking. This will result in potentially dangerous emergency braking which will not always result in an impact being avoided.

Tailgating increases the risk of an accident.

### **Warning!**

The DISTRONIC brakes your vehicle with a maximum deceleration of 6.5 ft/s<sup>2</sup> (2 m/s<sup>2</sup>). This corresponds to approximately 20% of the maximum deceleration of your vehicle.



The DISTRONIC brakes the vehicle in an effort to restore the preset distance or to maintain the set speed.

### **DISTRONIC menu in the control system**

The information shown in the multifunction display depends on whether the DISTRONIC system and/or the distance warning function are activated or deactivated.

-  To activate or deactivate the DISTRONIC system, see (> page 166) or see (> page 168).

To activate or deactivate the Distance warning function, see (> page 171).

- ▶ Press button  or  repeatedly until one of the following two displays appears in the multifunction display.

## Driving systems

### Distronic deactivated

When the DISTRONIC is deactivated, you will see the standard DISTRONIC display in the multifunction display.



- ① Preceding vehicle, if detected
- ② Actual distance to the preceding vehicle
- ③ Preset distance threshold to the preceding vehicle
- ④ Your vehicle
- ⑤ Symbol for activated distance warning function (▷ page 171)

### Distronic activated

When the DISTRONIC is activated, you will see the set speed in the multifunction display for approximately 5 seconds. The following display appears in the multifunction display.

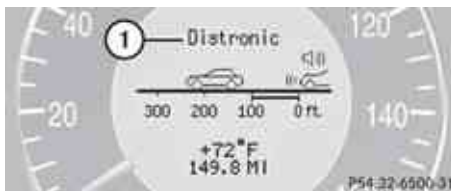

- ① DISTRONIC activated

### Cruise control lever

The DISTRONIC system is operated by means of the cruise control lever.

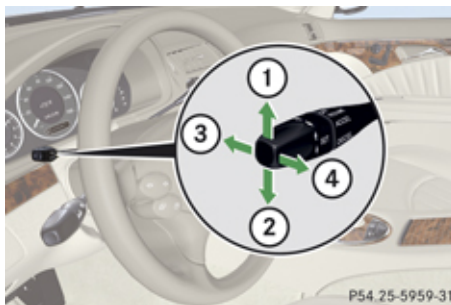

- ① Setting current or higher speed
- ② Setting current or lower speed

- ③ Deactivating the DISTRONIC
- ④ Activating the DISTRONIC, resuming to the last set speed or increasing speed in 1 mph (Canada: 1 km/h) increments

### Activating DISTRONIC

You can activate the DISTRONIC when the vehicle speed is between 20 mph (30 km/h) and 110 mph (180 km/h).

When the DISTRONIC is activated, one or two cruise control speed segments around the set speed in the multifunction display are illuminated. The multifunction display will briefly show a message such as DISTRONIC 55 MPH (Canada: DISTRONIC 90 km/h).

If the DISTRONIC is not activated after the cruise control lever is pulled in direction of arrow ④ (▷ page 166), you will see the message – in the multifunction display.

In the following cases you cannot activate the DISTRONIC:

- up to 2 minutes after starting the engine
- when you brake
- when you have engaged the parking brake



- when the automatic transmission is in park position **P**, reverse gear **R**, or neutral position **N**
- when the ESP® is switched off or has switched off due to a malfunction

The vehicle speed displayed on the speedometer can briefly vary from the speed setting on the DISTRONIC system.

### Setting the current speed

- ▶ Accelerate or decelerate to the desired speed.
- ▶ Briefly lift the cruise control lever in direction of arrow ① or depress in direction of arrow ② (▷ page 166).
- ▶ Remove your foot from the accelerator pedal.

- i** If you do not take your foot off of the accelerator pedal and continue to accelerate past the set speed, the following message will appear in the multifunction display:

DISTRONIC Override

The distance to a slower moving vehicle in front of you will not be set. Your vehicle

speed will then be determined only by the accelerator pedal position.

### Setting a higher speed

#### **Warning!**

Keep in mind that it may take a brief moment until the vehicle has made the necessary adjustments.

Increase the set vehicle speed to a value that the prevailing road conditions and legal speed limits permit. Otherwise, sudden and unexpected acceleration of the vehicle could cause an accident and/or serious injury to you and others.

You can increase the set speed in 1 mph (Canada: 1 km/h) increments or in 5 mph (Canada: 10 km/h) increments.

### Adjustment in 5 mph (Canada: 10 km/h) increments

- ▶ Briefly lift the cruise control lever up in direction of arrow ① (▷ page 166).  
The new speed is set and the vehicle will accelerate. Keep in mind that it may take a brief moment until the vehicle has reached the set speed.

### Fine adjustment in 1 mph (Canada: 1 km/h) increments

- ▶ Briefly pull the cruise control lever in direction of arrow ④ (▷ page 166).

### Setting a lower speed

#### **Warning!**

Keep in mind that it may take a brief moment until the vehicle has made the necessary adjustments.

Decrease the set vehicle speed to a value that the prevailing road conditions and legal speed limits permit. Otherwise, sudden and unexpected deceleration of the vehicle could cause an accident and/or serious injury to you and others.

- i** When you use the cruise control lever to decelerate, the brake system will automatically brake the vehicle if the engine's braking power does not brake the vehicle sufficiently.

## Driving systems

### Adjustment in 5 mph (Canada: 10 km/h) increments

- ▶ Briefly press the cruise control lever down in direction of arrow ② (▷ page 166). The new speed is set and the vehicle will decelerate. Keep in mind that it may take a brief moment until the vehicle has reached the set speed.

### Setting stored speed (Resume function)

#### **Warning!**

The set speed stored in memory should only be set again if prevailing road conditions and legal speed limits permit. Possible acceleration or deceleration differences arising from returning to the preset speed could cause an accident and/or serious injury to you and others.

- ▶ Briefly pull the cruise control lever in direction of arrow ④ (▷ page 166). If no speed is stored, the current speed is set and stored.
- ▶ Remove your foot from the accelerator pedal.

### Deactivating DISTRONIC

- ▶ Depress the brake pedal.  
or
- ▶ Briefly push the cruise control lever in direction of arrow ③ (▷ page 166). The cruise control speed segments in the multifunction display will go out and the following message appears briefly in the multifunction display: DISTRONIC Off  
The last set speed is stored for later use.

The last stored speed is deleted from memory when the engine is turned off.

The DISTRONIC switches off automatically when you depress the brake pedal or you engage the parking brake. In this case, the cruise control speed segments in the multifunction display will go out.

The DISTRONIC also switches off automatically when

- the vehicle speed falls below 20 mph (30 km/h)
- the ESP® is in operation
- the ESP® is switched off with the ESP® switch

- the ESP® has switched off due to a malfunction
- you shift the automatic transmission into neutral position **N** while driving

The cruise control speed segments in the multifunction display goes out and an acoustic warning will sound. Observe additional messages in the multifunction display that may appear.

#### **Warning!**

DISTRONIC switches off and releases the brakes when the vehicle decelerates below the minimum speed of 20 mph (30 km/h) by operation of the system. At that time the driver must apply the brakes in order to reduce vehicle speed further or bring it to a stop.

Depressing the accelerator pedal does not deactivate the DISTRONIC. After a brief acceleration (e.g. for passing), the DISTRONIC will resume the last set speed.

### Setting the following distance in DISTRONIC

You can set the specified following distance for DISTRONIC by varying the time setting between 1.0 and 2.0 seconds. Using this time

setting and the current speed of your vehicle, Distronic calculates and sets the required following distance to the preceding vehicle. The set distance will be shown in the multifunction display.

### **Warning!**

It is up to the driver to exercise discretion to select the appropriate setting given road conditions, traffic, driver's preferred driving style and applicable laws and driving recommendations for safe following distance.



① Thumbwheel for setting distance

► **Increasing distance:** Turn thumbwheel  
① towards .

Increasing the distance setting tells Distronic to maintain a greater following distance to the preceding vehicle.

► **Decreasing distance:** Turn thumbwheel  
① towards .

Decreasing the distance setting tells Distronic to maintain a shorter following distance to the preceding vehicle.

### Driving with Distronic

This section describes a number of driving situations where special precaution is required on the part of the driver. Be prepared to brake in such situations. Braking will deactivate the Distronic system.

### **Warning!**

Distronic works to maintain the speed selected by the driver unless a moving obstacle proceeding directly ahead of it in the same travel direction is detected (e.g. following another vehicle ahead of you at your set distance).

This means that:

- Your vehicle can pass another vehicle after you have changed lanes.
- While in a sharp turn or if the preceding vehicle is in a sharp turn, Distronic could lose sight of the preceding vehicle. Your vehicle could then accelerate to the previously selected speed.

Distronic regulates only the distance between your vehicle and those directly ahead of it, but does not register stationary objects in the road, e.g.:

- a stopped vehicle in a traffic jam
- a disabled vehicle
- an oncoming vehicle

The driver must always be alert, observe all traffic and intercede as required by means of steering or braking the vehicle.

### **Warning!**

Distronic should not be used in snowy or icy road conditions.

The most likely cause for a malfunctioning system is a dirty Distronic system sensor cover (located in the hood grille), especially at times of snow and ice or heavy rain.



## Driving systems

In such a case, Distronic will switch off, and the message **DISTRONIC Currently Unavailable - See Operator's Manual** appears in the multifunction display.

For cleaning and care of the Distronic system sensor cover, see (▷ page 285).

- ❗ If the message **DISTRONIC Currently Unavailable - See Operator's Manual** disappears during driving and the last set speed flashes for approximately 5 seconds, the dirt (e.g. slush) has dissolved; Distronic works again.

### Turns and bends

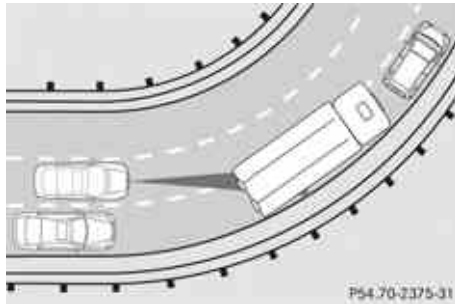

In turns or bends, Distronic may not detect a moving vehicle in front, or it may detect one too soon. This may cause your vehicle to brake late or unexpectedly.

### Offset driving

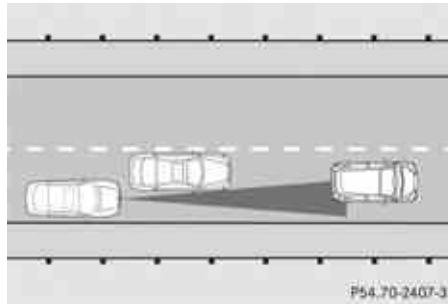

A vehicle traveling in your lane but offset from your direct line of travel may not be detected by Distronic. There will be insufficient distance to the preceding vehicle.

### Lane changing

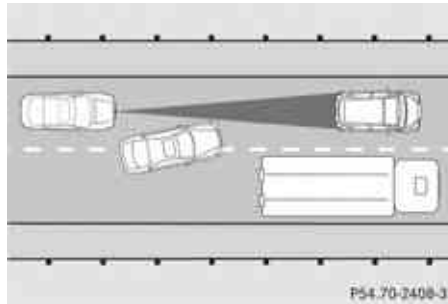

Distronic has not yet detected the vehicle changing lanes. There will be insufficient distance to the lane-changing vehicle.

### Narrow vehicles

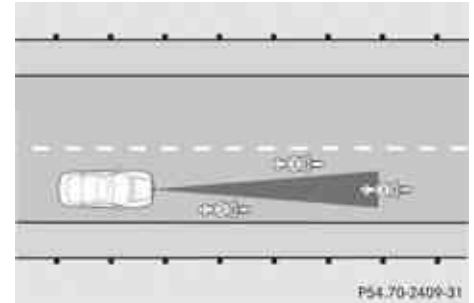

Because of their narrow profile, the vehicles traveling near the outer edges of the lane have not yet been detected by Distronic. There will be insufficient distance to the preceding vehicles.

## Distance warning function

When the DISTRONIC is deactivated, this function will continue to warn you when recognizing a stationary obstacle or a slower vehicle moving in your vehicle's path and the danger of a collision exists:

- The distance warning lamp  in the instrument cluster comes on.
- An intermittent warning will sound if necessary.

If these warnings are issued, you must brake manually to maintain a safe distance and avoid a collision with the preceding vehicle.

When depressing the brake pedal, the warning sound ceases. The warning sound will also cease when the distance to the preceding vehicle is sufficient again without applying the brakes. In this case, the distance warning lamp  will also go out.

### **Warning!**

If the distance warning lamp  in the instrument cluster comes on while driving and/or an intermittent warning sounds, immediate attention on the part of the driver is required. As required by the traffic situation, apply the brakes and navigate around a possible obstacle. However, do

not drive by relying on the distance warning function, as this will result in an emergency braking application. This will not always enable you to avoid a collision, especially when traveling on varying road surface conditions and with varying driver reaction. Complex driving situations are not always fully recognized by the distance warning function. This could result in wrong or missing distance warnings.



- ① Distance warning function on/off switch
- ② Indicator lamp

► **Activating/deactivating:** Press switch ①.

When the distance warning function is activated, indicator lamp ② in switch ①

comes on. A loudspeaker symbol appears in the multifunction display (▷ page 166).

## AIRMATIC DC (Dual Control)

### Introduction

The AIRMATIC DC consists of two components. The Adaptive Damping System (ADS) (▷ page 171) and the vehicle level control (▷ page 172).

### Adaptive Damping System (ADS)

The fine tuning of the damping is dependent on:

- road surface conditions
- your driving style
- vehicle loading
- your personal settings

## Driving systems

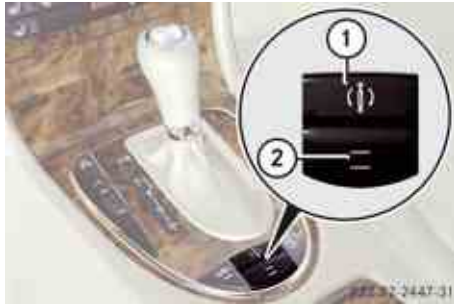

- ① ADS switch
- ② Indicator lamps

The following settings are available:

- **Comfort**  
Both indicator lamps ② are off.
  - **Sport 1**  
One indicator lamp ② is on.
  - **Sport 2**  
Both indicator lamps ② are on.
- ▶ Start the engine.
- ▶ Press ADS switch ① repeatedly until the desired suspension tuning is reached.

The setting remains stored when you turn off the engine.

### **⚠ Warning!**

If you have selected the Comfort suspension tuning, the vehicle lowers slightly when you lock it within approximately 60 seconds after turning off the engine. To avoid personal injury, make sure nobody is in the vicinity of the wheel housing or under the vehicle when you turn off the engine.

- ❗ When parking, make sure there is sufficient clearance under the vehicle for it to lower without making contact with the road curb for example. Otherwise, the vehicle could be damaged.

### Vehicle level control

#### **⚠ Warning!**

To help avoid personal injury, keep hands and feet away from wheel housing area, and

stay away from under the vehicle when lowering the vehicle chassis.

Your vehicle automatically adjusts its ride height to increase vehicle safety and to reduce fuel consumption.

You can choose between raised or normal level.

The vehicle chassis ride height is raised or lowered according to the selected level setting and to the vehicle speed. At a speed exceeding approximately 68 mph (110 km/h) with normal level set or exceeding 75 mph (120 km/h) with raised level set, the ride height is reduced automatically. With decreasing speed, the ride height is again raised to the normal level.

**i** These height adjustment are so small that you may not notice any change.

Select the raised level only when required by current driving conditions. Otherwise, the handling may be impaired and the fuel consumption may increase.

The following vehicle level settings can be selected when the vehicle is stationary and the engine is running:

Vehicle level when stationary	Indicator lamp (▷ page 174)	Suspension tuning	Use for	Ride height increase over normal	Automatic lowering
Normal	Lamp off	Comfort	For driving on normal roads	None	Max. approx. 0.4 in (10 mm)
Normal	Lamp off	Sport 1 or 2	For driving on normal roads	None	Max. approx. 0.6 in (15 mm)
Raised	Lamp on	Comfort	For driving on rough roads or with snow chains	Approx.. 0.8 in (20 mm)	Max. approx. 1.2 in (30 mm)
Raised	Lamp on	Sport 1 or 2	For driving on rough roads or with snow chains	Approx.. 0.8 in (20 mm)	Max. approx. 1.4 in (35 mm)

## Driving systems

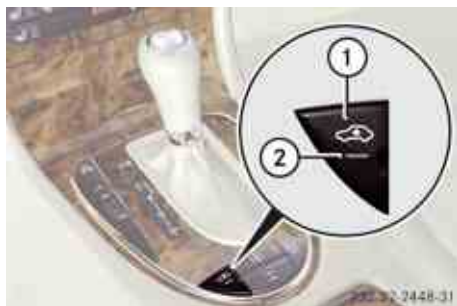

- ① Vehicle level control switch
- ② Indicator lamp

- ▶ Start the engine.
- ▶ Briefly press switch ① to change from normal level to raised level. When vehicle is at raised level, pressing switch ① will return the vehicle to normal level.

The setting raised is canceled and the vehicle is lowered to the normal level automatically if the vehicle speed is above 75 mph (120 km/h) or if the vehicle speed stays between 50 mph (80 km/h) and 75 mph (120 km/h) for approximately 5 minutes. Indicator lamp ② in switch ① goes out.

If you do not drive in this speed range, the selected vehicle level setting remains stored

in memory even if the SmartKey is removed from the starter switch.

### All-wheel drive (4MATIC)

Your vehicle is equipped with all-wheel drive (4MATIC). Both, the front and rear axles, are powered at all times when the vehicle is being operated. The 4MATIC improves traction in conjunction with the ESP® (▷ page 72) and the Electronic Traction System (ETS/4-ETS) (▷ page 73).

#### **⚠ Warning!**

If a drive wheel is spinning due to insufficient traction:

- While driving off, apply as little throttle as possible.
- While driving, ease up on the accelerator pedal.
- Adapt your speed and driving style to the prevailing road conditions.

Failure to observe these guidelines could cause the vehicle to skid.

The 4MATIC cannot prevent accidents resulting from excessive speed.

**!** Do not tow with one axle raised. Doing so could damage the transfer case, which is not covered by the Mercedes-Benz Limited Warranty. All wheels must be on or off the ground. Observe instructions for towing the vehicle with all wheels on the ground.

**!** Only conduct operational or performance tests on a two-axle dynamometer. If such tests are necessary, contact an authorized Mercedes-Benz Center. You could otherwise seriously damage the brake system and/or the transfer case which is not covered by the Mercedes-Benz Limited Warranty.

**i** In winter operation, the maximum effectiveness of the 4MATIC is only achieved with winter tires (▷ page 272) or snow chains as required.



### Parktronic system

The Parktronic system is an electronic parking aid with ultrasonic sensors designed to assist the driver during parking maneuvers. It indicates the relative distance between the vehicle and an obstacle visually and audibly. The Parktronic system is activated automatically when you

- switch on the ignition and
- release the parking brake and
- the automatic transmission is in drive position **D**, reverse gear **R**, or neutral position **N**

The Parktronic system deactivates at speeds above approximately 11 mph (18 km/h). At lower speeds, the Parktronic system switches on again.

The Parktronic system also deactivates when you shift the automatic transmission into park position **P** or engage the parking brake. The Parktronic system monitors the surroundings of your vehicle with six sensors in the front bumper and four sensors in the rear bumper.



① Sensors in the front bumper

To function properly, the sensors must be free of dirt, ice, snow and slush. Clean the sensors regularly, being careful not to scratch or damage the sensors, see “Cleaning the Parktronic system sensors” (▷ page 285).

#### **Warning!**

The Parktronic is a supplemental system. It is not intended to, nor does it replace, the need for extreme care. The responsibility during parking and other critical maneuvers always remains with the driver.

#### **Warning!**

Make sure no persons or animals are in or near the area in which you are parking/ maneuvering. Otherwise, they could be injured.

**!** Special attention must be paid to objects with smooth surfaces or low silhouettes (e.g. trailer couplings, painted posts, elevated crossbars or road curbs). Such objects may not be detected by the system and can damage the vehicle.

During parking maneuvers, pay special attention to objects located above or below the height of the sensors (e.g. street curbs, painted posts, or trailer hitches etc.). The Parktronic system will not detect such objects at close range and damage to your vehicle or the object may result.

**!** Ultrasonic signals from outside sources (e.g. truck air brakes, car wash, or jackhammers) may impair the operation of the Parktronic system.

## Driving systems

### Range of the sensors

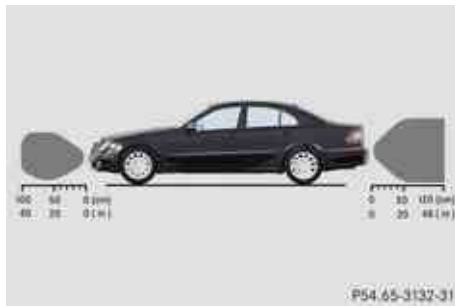

### Front sensors

Center	approx. 40 in (100 cm)
Corners	approx. 24 in (60 cm)

### Rear sensors

Center	approx. 48 in (120 cm)
Corners	approx. 32 in (80 cm)

### Minimum distance

Center	approx. 8 in (20 cm)
Corners	approx. 6 in (15 cm)

If the Parktronic system detects an obstacle in this range, all the distance warning segments illuminate and you hear a warning signal. If the obstacle is closer than the minimum distance, the actual distance may no longer be indicated by the Parktronic system.

### Warning indicators

Visual signals indicate to the driver the relative distance between the sensors and an obstacle.

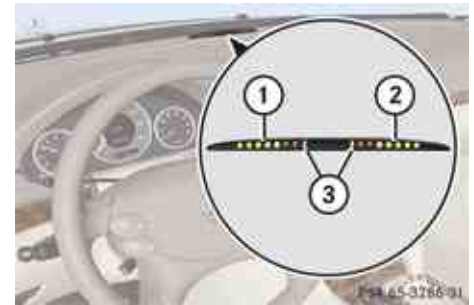

Front area warning indicator

- ① Left side of the vehicle
- ② Right side of the vehicle
- ③ Readiness indicators

## Driving systems

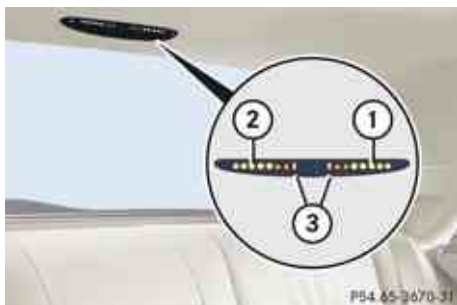

Rear area warning indicator

- ① Left side of the vehicle
- ② Right side of the vehicle
- ③ Readiness indicators

Each warning indicator is divided into five yellow and two red distance segments for either side of the vehicle. The Parktronic system is ready to measure when the yellow readiness indicators ③ are illuminated.

The current transmission position determines which warning indicator will be activated.

Current transmission position	Warning indicator
D	Front area activated
R or N	Front and rear area activated

As your vehicle approaches an object, one or more distance segments will illuminate, depending on the distance. When the seventh distance segment illuminates, you have reached the minimum distance.

- **Front area:** An intermittent acoustic warning will sound as the first red distance segment illuminates and a constant acoustic warning lasting a maximum of 2 seconds will sound for the second red distance segment. The signal is canceled when the automatic transmission is shifted into park position **P** or the parking brake is engaged.
- **Rear area:** An intermittent acoustic warning will sound as the first red distance segment illuminates and a constant acoustic warning lasting a maximum of 2 seconds will sound for the second red distance segment. The signal is canceled when the automatic transmission is shifted

into drive position **D**, or park position **P**, or the parking brake is engaged.

### Switching the Parktronic system on/off

The Parktronic system switches on automatically when the ignition is switched on.

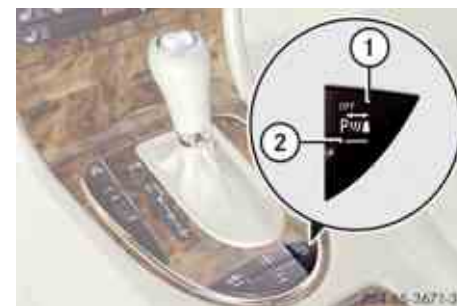

- ① Parktronic switch
- ② Indicator lamp

- ▶ **Switching off Parktronic system:** Press Parktronic switch ①. Indicator lamp ② comes on.
- ▶ **Switching on Parktronic system:** Press Parktronic switch ① again.

### Driving systems

#### **Parktronic system malfunction**

---

There is a malfunction in the Parktronic system, if only the red distance segments illuminate and an acoustic warning sounds. The Parktronic system will switch off automatically after 20 seconds and indicator lamp ② in Parktronic switch ① comes on.

- ▶ Have the Parktronic system checked at an authorized Mercedes-Benz Center as soon as possible.

If only the red distance segments illuminate and no acoustic warning sounds, the Parktronic system sensors are dirty (e.g. dirt, ice, snow and slush) or there is an interference from other radio or ultrasonic signals (e.g. truck air brakes, car wash, or jackhammers). The Parktronic system will switch off automatically after 20 seconds and indicator lamp ② in Parktronic switch ① comes on.

- ▶ Switch off the ignition.
- ▶ Clean the Parktronic system sensors (▷ page 285).
- ▶ Switch on the ignition.  
or
- ▶ Check the Parktronic system operation at another location to rule out interference from outside radio or ultrasonic signals.

## Climate control system

## Overview of climate control system functions

Your vehicle is equipped with either of the following climate control systems:

## Dual-zone automatic climate control



The dual-zone automatic climate control combines an automatic heating and ventilation system with a cooling system. You can adjust the dual-zone automatic climate control separately for the driver's and passenger side.

## 4-zone automatic climate control



The 3-zone automatic climate control combines an automatic heating and ventilation system with a cooling system. You can adjust the 3-zone automatic climate control separately for each zone in the vehicle.

## Rear climate control



The rear climate control allows separate climate settings for the rear compartment.



## Climate control system

### Control panels

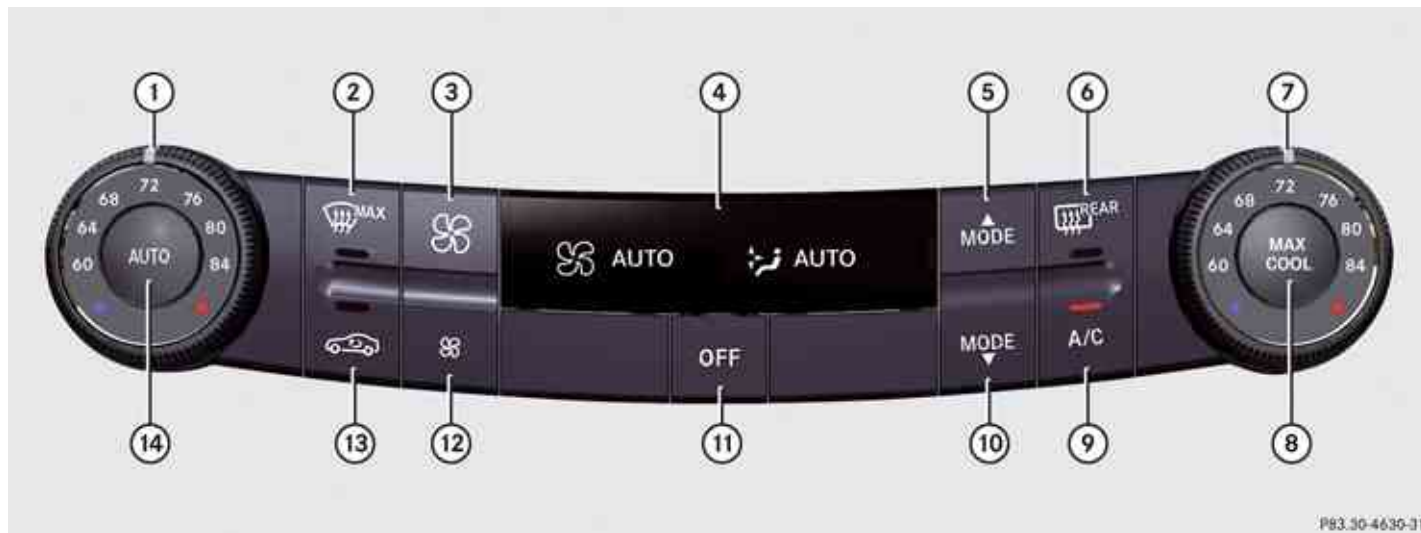









#### Dual-zone automatic climate control



P83.30-4630-31

	Function	Recommendation/Notes	
①	Temperature control, driver's side	<b>i</b> Set the temperature to 72°F (22°C).	(> page 186)
②	 Front defroster	<b>i</b> Keep this setting selected only until the windshield or the side windows are clear again.	(> page 190)
③	 Increasing air volume		(> page 190)

Climate control system



	Function	Recommendation/Notes	
④	Display		
⑤	 Air distribution		(▷ page 189)
⑥	 Rear window defroster	<b>i</b> At very low temperatures, rear window defroster operation is delayed until the vehicle interior has warmed up.	(▷ page 193)
⑦	Temperature control, passenger side	<b>i</b> Set the temperature to 72°F (22°C).	(▷ page 186)
⑧	MAX COOL on/off (USA only)		(▷ page 191)
	 Residual heat/ventilation (Canada only)		(▷ page 192)
⑨	 AC cooling on/off	<b>i</b> Switches on the air conditioning. The indicator lamp in button  comes on.	(▷ page 185)
⑩	 Air distribution		(▷ page 189)
⑩	 Climate control on/off	<b>i</b> Switches on the climate control system. Display  comes on.	(▷ page 185)
⑪	 Decreasing air volume		(▷ page 190)
⑫	 Air recirculation	<b>i</b> Only use this function for a short time, e.g. in a tunnel. Otherwise, the windows can fog up due to lack of fresh air.	(▷ page 192)
⑬	 Air distribution and air volume (automatic mode)	<b>i</b> Switches on the automatic mode. AUTO appears in display.	(▷ page 186)

## Climate control system

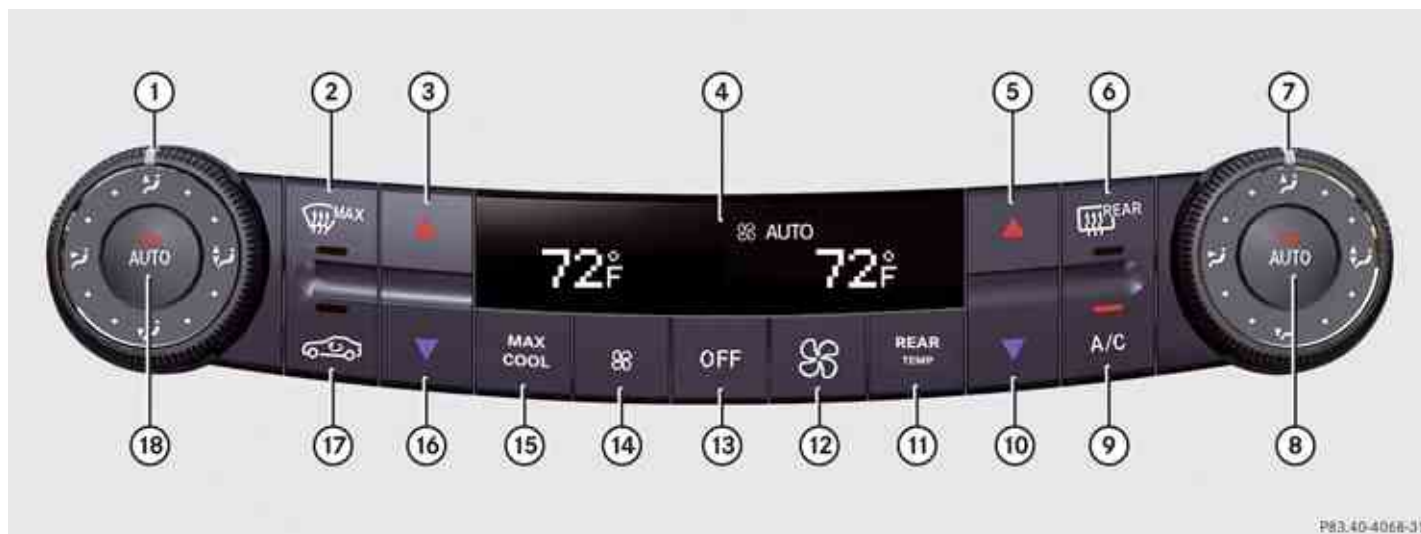
### 4-zone automatic climate control





















P83.40-4068-31







	Function	Recommendation/Notes	
①	Air distribution, driver's side		(▷ page 189)
②	 Front defroster	<b>i</b> Keep this setting selected only until the windshield or the side windows are clear again.	(▷ page 190)
③	 Temperature control, driver's side, raising	<b>i</b> Set the temperature to 72°F (22°C).	(▷ page 186)
④	Display		



## Climate control system





	Function	Recommendation/Notes	
⑤	 Temperature control, passenger side, raising	 Set the temperature to 72°F (22°C).	(▷ page 186)
⑥	 Rear window defroster	 At very low temperatures, rear window defroster operation is delayed until the vehicle interior has warmed up.	(▷ page 193)
⑦	Air distribution, passenger side		(▷ page 189)
⑧	 Air distribution and air volume, passenger side (automatic mode)	 Switches on the automatic mode. The indicator lamp in button <b>AUTO</b> comes on.	(▷ page 186)
⑨	 AC cooling on/off	 Switches on the air conditioning. The indicator lamp in button  comes on.	(▷ page 185)
⑩	 Temperature control, passenger side, lowering	 Set the temperature to 72°F (22°C).	(▷ page 186)
⑪	 Rear air-conditioning remote control (USA only)		(▷ page 186)
	 Rear air-conditioning remote control (Canada only)		
⑫	 Increasing air volume		(▷ page 190)
⑬	 Climate control on/off	 Switches on the climate control system. The indicator lamp in button <b>OFF</b> goes out.	(▷ page 185)
⑭	 Decreasing air volume		(▷ page 190)
⑮	MAX COOL on/off (USA only)		(▷ page 191)
	 Residual heat/ventilation (Canada only)	 With the engine turned off, it is possible to continue to heat or ventilate the interior.	(▷ page 192)

## Climate control system

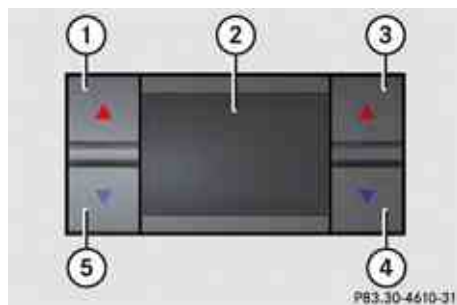
	Function	Recommendation/Notes	
16	 Temperature control, driver's side, lowering	 Set the temperature to 72°F (22°C).	(▷ page 186)
17	 Air recirculation	 Only use this function for a short time, e.g. in a tunnel. Otherwise, the windows can fog up due to lack of fresh air.	(▷ page 192)
18	 Air distribution and air volume, driver's side (automatic mode)	 Switches on the automatic mode. The indicator lamp in button <b>AUTO</b> comes on.	(▷ page 186)

## Rear climate control



- ①  Temperature control, left, raising
- ② Display
- ③  Temperature control, right, raising
- ④  Temperature control, right, lowering
- ⑤  Temperature control, left, lowering

## Notes on climate control system

The climate control system is operational whenever the engine is running. You can operate the climate control system in either the automatic or manual mode. The system cools or heats the interior depending on the selected interior temperature and the current outside temperature.

It can only function optimally when you are driving with the windows, the tilt/sliding sunroof or tilt/sliding panel closed.

Nearly all dust particles, pollutants and odors are filtered out before outside air enters the passenger compartment through the air distribution system.

## Warning!

Severe conditions (e.g. strong air pollution) may require replacement of the filter before its scheduled replacement interval. A clogged filter will reduce the air volume to the interior and the windows could fog up, impairing visibility and endangering you and others. Have a clogged filter replaced as soon as possible at an authorized Mercedes-Benz Center.

The air conditioning will not engage (no cooling) if the **A/C** mode (▷ page 185) is deactivated.

## Warning!

Follow the recommended settings for heating and cooling given on the following pages. Otherwise the windows could fog

## Climate control system

up, impairing visibility and endangering you and others.

- ▶ Keep the air intake grille in front of the windshield free of snow and debris.

Do not obstruct air flow by placing objects on the air flow-through exhaust slots below the rear window.

- i** If the vehicle interior is hot, ventilate the interior before driving off, see “Summer opening feature” (▷ page 122). The climate control will then adjust the interior temperature to the set value much faster.

## Deactivating the climate control system

**⚠ Warning!**

When the climate control system is switched off, the outside air supply and circulation are also switched off. Only choose this setting for a short time. Otherwise the windows could fog up, impairing visibility and endangering you and others.

## Dual-zone automatic climate control

- ▶ **Deactivating:** Press button **OFF**.  
OFF appears in display ⑤ (▷ page 180).
- ▶ **Reactivating:** Press button **OFF**.  
Display ⑤ comes on. The previous settings are once again in effect.

## 4-zone automatic climate control

- ▶ **Deactivating:** Press button **OFF**.  
0 appears in display ④ (▷ page 182).
- ▶ **Reactivating:** Press button **OFF**.  
Display ④ comes on. The previous settings are once again in effect.

## Air conditioning

The air conditioning is operational while the engine is running and cools the interior air to the temperature set by the operator. In addition, the air conditioning dehumidifies the interior air and helps prevent window fogging.

**⚠ Warning!**

If you switch off the cooling function, the vehicle will not be cooled when weather conditions are warm. The windows can fog

up more quickly. Window fogging may impair visibility and endanger you and others.

- i** Condensation may drip out from underneath the vehicle. This is normal and not an indication of a malfunction.

## Deactivating

It is possible to deactivate the air conditioning. The interior air will then no longer be cooled or dehumidified.

- ▶ Press button **A/C**.  
The indicator lamp in the button goes out.  
The cooling function switches off after a short delay.

## Activating

Moist air can fog up the windows. You can dehumidify the interior air with the air conditioning.

- ▶ Press button **A/C**.  
The indicator lamp in the button comes on.  
The air conditioning uses the refrigerant R134a. This refrigerant is free of CFCs which are harmful to the ozone layer.

## Climate control system

### Automatic mode





When operating the climate control system in automatic mode, the interior air temperature, air volume and air distribution are adjusted automatically.

In automatic mode, cooling with dehumidification is switched on. This function can be switched off if necessary.

### Warning!



If you switch off the cooling function, the vehicle will not be cooled when weather conditions are warm. The windows can fog up more quickly. Window fogging may impair visibility and endanger you and others.

### Dual-zone automatic climate control





- ▶ Set the desired temperature (▷ page 186).
- ▶ **Activating:** Press button . The AUTO indicator for automatic air volume and air distribution in display  (▷ page 180) comes on. The air volume and air distribution are adjusted automatically.
- ▶ **Deactivating:** Press button  or . The AUTO indicator for air volume in display  (▷ page 180) goes out. The automatic operation of air volume switches off, and

air volume is controlled according to the desired setting. Automatic air distribution remains switched on.

or



- ▶ Press air distribution control rocker switch  or  (▷ page 180). The AUTO indicator for air distribution in display  goes out. The automatic operation of air distribution switches off, and air distribution is controlled according to the desired position. Automatic air volume remains switched on.

### 4-zone automatic climate control

- ▶ Set the desired temperature (▷ page 186).
- ▶ **Activating:** Press button . The indicator lamp on the button comes on. The AUTO indicator for automatic air volume and air distribution in display  (▷ page 182) comes on. The air volume and air distribution are adjusted automatically.
- ▶ **Deactivating:** Press button  or . The AUTO indicator for air volume in display  (▷ page 182) goes out. The automatic operation of air volume switches off, and air volume is controlled according to the

desired setting. Automatic air distribution remains switched on.



or

- ▶ Turn air distribution control  or  (▷ page 182) on each side of the passenger compartment to the desired symbol. The indicator lamp in the corresponding button goes out. Automatic air distribution is switched off in the corresponding zone, and air distribution is controlled according to the desired position. Automatic air volume remains switched on.

### Setting temperature

#### Dual-zone automatic climate control

You can adjust the air temperature on each side of the passenger compartment. You should raise or lower the temperature setting in small increments, preferably starting at 72°F (22°C).

- ▶ **Increasing/decreasing:** Turn temperature controls  and  (▷ page 180) slightly clockwise or counterclockwise.

## Climate control system

**4-zones automatic climate control**

You can set the air temperature for each of the 4 zones separately. You should raise or lower the temperature setting in small increments, preferably starting at 72°F (22°C).

**Front zones**

- ▶ **Increasing/decreasing:** Press button ▲ or ▼ until the desired temperature appears in display ④ (▷ page 182).

**Rear zones**

- ▶ Press button REAR TEMP<sup>11</sup> or <sup>12</sup>. Display ④ (▷ page 182) comes on.
- ▶ **Increasing/decreasing:** Press button ▲ or ▼ until the desired temperature appears in display ④. After approximately 5 seconds after the last adjustment, display ④ switches back to its standard display.

- ① You can also press button REAR TEMP or  once more to switch back to the standard display.

**Rear climate control panel**

You can adjust the air temperature on each side of the rear passenger compartment. You should raise or lower the temperature setting in small increments, preferably starting at 72°F (22°C).

- ▶ **Increasing/decreasing:** Press button ▲ or ▼ until the desired temperature appears in display ② (▷ page 184).

**Adjusting air vents****⚠ Warning!**

When operating the climate control, the air that enters the passenger compartment through the air vents can be very hot or very cold (depending on the set temperature). This may cause burns or frostbite to unprotected skin in the immediate area of the air vents.

Always keep sufficient distance between unprotected parts of the body and the air vents. If necessary, use the air distribution adjustment to direct the air to air vents in the vehicle interior that are not in the immediate area of unprotected skin.

For best possible performance of the climate control:

- ▶ Keep the air intake grille in front of the windshield free of snow, leaves, sticks, and any other debris.
- ▶ Always keep all air vents and grilles in the passenger compartment free from obstruction.

<sup>11</sup> USA only

<sup>12</sup> Canada only

## Climate control system

- 1 For draft-free ventilation, move the adjustable center and side air vents to the middle position.

### Center air vents

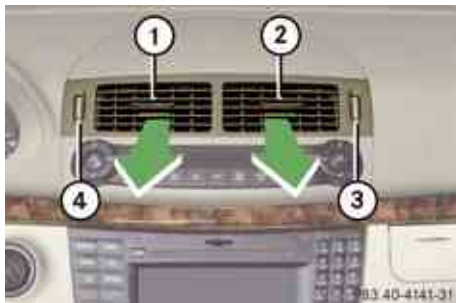

- 1 Left center air vent, adjustable
  - 2 Right center air vent, adjustable
  - 3 Thumbwheel for air volume control for adjustable right center air vent
  - 4 Thumbwheel for air volume control for adjustable left center air vent
- **Opening/closing:** Turn thumbwheels 3 and 4 upward or downward.

### Side air vents

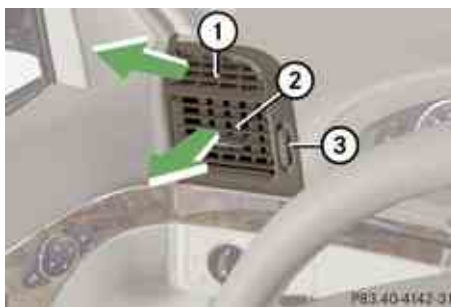

Example illustration driver's side

- 1 Left side defroster air vent, fixed
  - 2 Left side air vent, adjustable
  - 3 Thumbwheel for air volume control for adjustable left side air vent
- **Opening/closing:** Turn thumbwheel 3 upward or downward.

### Rear center console air vents



Example illustration: Dual-zone automatic climate control

- 1 Left rear center air vent, adjustable
  - 2 Right rear center air vent, adjustable
  - 3 Thumbwheel for air volume control for right rear center air vent
  - 4 Thumbwheel for air volume control for left rear center air vent
- **Opening/closing:** Turn thumbwheel 3 or 4 upward or downward.

Climate control system

B-pillar air vents



Vehicles with 4-zone automatic climate control only

- ① Thumbwheel for air volume control for side air vent
  - ② Side air vent, adjustable
- **Opening/closing:** Turn thumbwheel ① to the left or to the right.

Adjusting air distribution

Dual-zone automatic climate control

The air distribution can be adjusted manually. The symbols located in display ④ (> page 180) represent the following functions:

Symbol	Function
	Directs air into the entire vehicle interior
	Directs air to the windshield, through the side air vents and cockpit air vent (Canada only)
	Directs air to the windshield and through the side defroster air vents
	Directs air to the windshield, through the side air vents and to the footwells
	Directs air through the cockpit (Canada only), center, side and rear passenger compartment air vents

Symbol	Function
	Directs air to the footwells
	Directs air to the footwells and through the side air vents

- Press air distribution control rocker switch **MÓDE** or **MQDE** until the desired symbol appears in display ④ (> page 180). The AUTO indicator for automatic air distribution in display ④ goes out. The automatic mode is switched off, and air distribution is controlled according to the desired setting.

4-zone automatic climate control

The air distribution can be adjusted separately on each side of the passenger compartment. The symbols on the buttons represent the following functions:

## Climate control system

Symbol	Function
	Directs air through the center, side and defroster air vents to the windshield and side windows
	Directs air through the Cockpit (Canada only), center, side and rear passenger compartment air vents
	Directs air into the entire vehicle interior
	Directs air to the footwells

- ▶ Turn air distribution controls ① and ⑦ (▷ page 182) on each side of the passenger compartment to the desired symbol. The indicator lamp in the corresponding button goes out and the automatic mode is switched off for the corresponding side. The air distribution is adjusted according to the chosen setting.

You can also turn the air distribution control to a position between two symbols.

### Adjusting air volume

- ▶ **Decrease/increase:** Press button or .

### Front defroster

You can use this setting to defrost the windshield, for example if it is iced up.

You can also defog the windshield and the side windows.

- ⓘ Keep this setting selected only until the windshield or the side windows are clear again.

### Dual-zone automatic climate control

- ▶ **Activating:** Press button . The indicator lamp in the button comes on. The climate control switches to the following functions automatically:
  - cooling on to dehumidify
  - most efficient blower speed and heating power, depending on outside temperature
  - air flows onto the windshield and the front side windows
  - the air recirculation mode is switched off

- ▶ **Deactivating:** Press button again. The indicator lamp in the button goes out. The previous settings are once again in effect. The cooling remains switched on. The air recirculation remains switched off.

or

- ▶ Press button **AUTO**. The indicator lamp in button goes out. Air volume and air distribution are adjusted automatically.

or

- ▶ Turn temperature controls ① or ⑦ (▷ page 180) clockwise or counterclockwise.

or

- ▶ Press button or .

### 4-zone automatic climate control

- ▶ **Activating:** Press button . The indicator lamp in the button comes on. The climate control switches to the following functions automatically:
  - cooling on to dehumidify
  - most efficient blower speed and heating power, depending on outside temperature



## Climate control system

- air flows onto the windshield and the front side windows
- the air recirculation mode is switched off

**i** You can adjust the air volume, air distribution and interior air temperature when the front defroster is switched on.



▶ **Deactivating:** Press button  again. The indicator lamp in the button goes out. The previous settings are once again in effect. The cooling remains switched on. The air recirculation remains switched off.

or

▶ Press button **AUTO**. The indicator lamp in button  goes out. Air volume and air distribution are adjusted automatically.

## Windshield fogged on the outside



### Dual-zone automatic climate control

- ▶ Switch the windshield wipers on (▷ page 118).
- ▶ Press button **M<sub>ODE</sub>** or **M<sub>QDE</sub>** until the setting ,  or  appears in display **④** (▷ page 180).

<sup>13</sup> Vehicles with dual-zone automatic climate control

<sup>14</sup> Vehicles with 4-zone automatic climate control

### 4-zone automatic climate control

- ▶ Switch the windshield wipers on (▷ page 118).
- ▶ Turn air distribution controls **①** and **⑦** (▷ page 182) to  or .

### Maximum cooling MAX COOL

MAX COOL is only operational when the engine is running.

MAX COOL is only available in U.S. vehicles. You can use this setting to provide the fastest possible cooling of the vehicle interior (when windows and tilt/sliding sunroof or tilt/sliding panel are closed).



- ▶ **Activating:** Press button **⑧**<sup>13</sup> (▷ page 180) or **⑮**<sup>14</sup> (▷ page 182). MAX

COOL appears in display **④** (▷ page 180) or (▷ page 182).

The air conditioning switches automatically to the following functions:

- maximum cooling
- maximum blowing power
- the air recirculation mode is switched on

▶ **Deactivating:** Press button **⑧** or **⑮** again. MAX COOL disappears in display **④**. The previous settings are once again in effect.

**i** To switch the maximum cooling function off, you can also press button **OFF**, **AUTO**,  or .

## Climate control system

### Air recirculation mode

Switch to air recirculation mode to prevent unpleasant odors from entering the vehicle from the outside (e.g. before driving through a tunnel). This setting cuts off the intake of outside air and recirculates the air in the passenger compartment.

#### **Warning!**

Fogged windows impair visibility, endangering you and others. If the windows begin to fog on the inside, switching off the air recirculation mode immediately should clear interior window fogging. If interior window fogging persists, make sure the air conditioning is activated, or press button



▶ **Activating:** Press button .

The indicator lamp in the button comes on.

**i** The air recirculation mode is activated automatically at high outside temperatures and if the concentration of carbon monoxide (CO) and nitrogen oxide in the outside air increases, for example in a tunnel.

The indicator lamp in button  is not lit when the air recirculation mode is switched on automatically.

A quantity of outside air is added after approximately 30 minutes.

▶ **Deactivating:** Press button  again. The indicator lamp in the button goes out.

**i** The manually selected air recirculation mode is deactivated automatically:

- after 5 minutes if the outside temperature is below approximately 41°F (5°C)
- after 5 minutes if the air conditioning is turned off
- after 30 minutes if the outside temperature is above approximately 41°F (5°C)

### Residual heat and ventilation

This feature is only available in Canada vehicles. With the engine switched off, it is possible to continue to heat or ventilate the interior for up to 30 minutes. This feature makes use of the residual heat produced by the engine.

**i** If you switch on the residual heat function when outside temperatures are high, only the ventilation will be switched on.

**i** Regardless of the selected air volume, the blower operates at low speed.

**i** How long the system will provide heating depends on the coolant temperature and the selected temperature. The blower will run at speed setting **1** regardless of the air volume control setting.

▶ **Activating:** Switch off the ignition.

▶ Press button .

The indicator lamp in the button comes on.

▶ **Deactivating:** Press button .

The indicator lamp in the button goes out.

## Rear window defroster

The residual heat is deactivated automatically:



- when the ignition is switched on
- after approximately 30 minutes
- if the battery voltage drops
- if the coolant temperature is too low

## Rear window defroster

 **Warning!**

Any accumulation of snow and ice should be removed from the rear window before driving. Visibility could otherwise be impaired, endangering you and others.

The rear window defroster uses a large amount of power. To keep the battery drain to a minimum, switch off the defroster as soon as the rear window is clear. The defroster is switched off automatically after some time of operation depending on the outside temperature.

- ▶ Switch on the ignition.
- ▶ **Switching on:** Press button  on the respective climate control panel. The indicator lamp in the button comes on.
- ▶ **Switching off:** Press button  again.

**!** If the rear window defroster switches off too soon and the indicator lamp starts flashing, too many electrical consumers are operating simultaneously and there is insufficient voltage in the battery. The system responds automatically by switching the rear window defroster off.

As soon as the battery has sufficient voltage, the rear window defroster switches back on automatically.

## Power tilt/sliding sunroof

### Power tilt/sliding sunroof

#### Opening and closing

#### **⚠ Warning!**

When opening or closing the tilt/sliding sunroof, make sure there is no danger of anyone being harmed by the opening/closing procedure.

The tilt/sliding sunroof is equipped with the express operation and automatic reversal function. If the movement of the tilt/sliding sunroof is blocked during the closing procedure, the tilt/sliding sunroof will stop and open slightly.

The tilt/sliding sunroof operates differently when the sunroof switch is pressed and held. See the “Closing when the tilt/sliding sunroof is blocked” section for details.

The opening/closing procedure of the tilt/sliding sunroof can be immediately halted by releasing the sunroof switch or, if the sunroof switch was moved past the resistance point and released, by moving the sunroof switch in any direction.

**⚠ Observe Safety notes, see page 62.**

#### **⚠ Warning!**

The tilt/sliding sunroof is made out of glass. In the event of an accident, the glass may shatter. This may result in an opening in the roof.

In a vehicle rollover, occupants not wearing their seat belts or not wearing them properly may be thrown out of the opening. Such an opening also presents a potential for injury for occupants wearing their seat belts properly as entire body parts or portions of them may protrude from the passenger compartment.

**!** To avoid damaging the seals, do not transport any objects with sharp edges which can stick out of the tilt/sliding sunroof.

Do not open the tilt/sliding sunroof if there is snow or ice on the roof, as this could result in malfunctions.

If you cannot open or close the tilt/sliding sunroof due to a malfunction contact Roadside Assistance or an authorized Mercedes-Benz Center.

**!** Please keep in mind that weather conditions can sometimes change rapidly. Make sure to close the tilt/sliding sunroof when leaving the vehicle. If water enters the vehicle interior, vehicle electronics could be damaged which is not covered by the Mercedes-Benz Limited Warranty.

**i** You can also open or close the tilt/sliding sunroof using the SmartKey or the KEYLESS-GO function, see “Summer opening feature” (> page 122) and “Convenience closing feature” (> page 123).

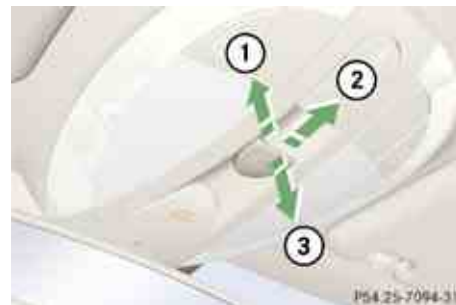

Sunroof switch

- ① Raising
- ② Opening
- ③ Closing

## Power tilt/sliding sunroof

With the sunroof closed or raised, you can slide the sunroof screen forward and back.



Sunroof screen

- ▶ Switch on the ignition.

### Opening

- ▶ **Opening manually:** Press and hold the sunroof switch to the resistance point in direction of arrow ②.
- ▶ Release the sunroof switch when the desired position is reached.
- ▶ **Express operation:** To open the tilt/sliding sunroof completely, press the sunroof switch past the resistance point in direction of arrow ② and release.
- ▶ **Stopping during express operation:** Move the sunroof switch in any direction.

- ① Express opening is not available when the tilt/sliding sunroof is raised. The tilt/sliding sunroof must be closed first.

- ① When the tilt/sliding sunroof is open, resonance noises may result in addition to the usual wind noises. They are caused by minimal pressure changes in the passenger compartment. To reduce or eliminate these noises, change the position of the tilt/sliding sunroof or open a window slightly.

### Raising

- ▶ **Raising manually:** Press and hold the sunroof switch to the resistance point in direction of arrow ①.
- ▶ Release the sunroof switch when the desired position is reached.
- ▶ **Express operation:** To raise the tilt/sliding sunroof completely, press the sunroof switch past the resistance point in direction of arrow ① and release.
- ▶ **Stopping during express operation:** Move the sunroof switch in any direction.

- ① Express raising is not available when the tilt/sliding sunroof is open. The tilt/sliding sunroof must be closed first.

### Closing

- ▶ **Closing manually:** Pull and hold the sunroof switch to the resistance point in direction of arrow ③.
- ▶ Release the sunroof switch when the desired position is reached.
- ▶ **Express operation:** To close the tilt/sliding sunroof completely, pull the sunroof switch past the resistance point in direction of arrow ③ and release.
- ▶ **Stopping during express operation:** Move the sunroof switch in any direction.

### Closing when the tilt/sliding sunroof is blocked

#### ⚠ Warning!

Make sure that nobody can become trapped and be seriously or even fatally injured when closing the tilt/sliding sunroof with greater force or without automatic reversal function.

### Power tilt/sliding sunroof

If the movement of the tilt/sliding sunroof is blocked during the closing procedure (e. g. by ice or pollution), the tilt/sliding sunroof will stop and open slightly. However, the tilt/sliding sunroof will exert greater force before reversing than when the tilt/sliding sunroof is closed in express operation. Please exercise caution!

- ▶ Immediately after the tilt/sliding sunroof has stopped because it was blocked, pull the sunroof switch in direction of arrow ③ until the tilt/sliding sunroof is fully closed.

If the tilt/sliding sunroof is blocked again and opens slightly:

- ▶ Immediately after the tilt/sliding sunroof was blocked, pull the sunroof switch in direction of arrow ③ until the tilt/sliding sunroof is fully closed.

#### **Warning!**

Pulling and holding the sunroof switch to close the tilt/sliding sunroof immediately after it had been blocked two times will cause the tilt/sliding sunroof to close without any reversal function for as long as you hold the sunroof switch.

### Synchronizing

The tilt/sliding sunroof must be synchronized

- after the battery has been disconnected or discharged
- after a malfunction
- if the tilt/sliding sunroof does not open smoothly

 If the tilt/sliding sunroof cannot be closed or synchronized, contact an authorized Mercedes-Benz Center or call Roadside Assistance.

- ▶ Vehicles with SmartKey: Switch off the ignition and remove the SmartKey from the starter switch.
- ▶ Vehicles with KEYLESS-GO: Switch off the ignition and open the driver's door (this puts the starter switch in position **0**, same as with the SmartKey removed from the starter switch). The driver's door then can be closed again.
- ▶ Remove the fuse for the tilt/sliding sunroof from the fuse box (▷ page 375).
- ▶ Reinsert the fuse in the fuse box.
- ▶ Switch on the ignition.
- ▶ Press and hold the sunroof switch in direction of arrow ① (▷ page 194) until the

tilt/sliding sunroof is fully raised at the rear.

- ▶ Keep holding the sunroof switch in direction of arrow ① for approximately 1 second.
- ▶ Check the express operation feature (▷ page 195).  
If the tilt/sliding sunroof opens and closes completely, the roof is synchronized. Otherwise repeat the above steps.

Panorama roof with power tilt/sliding panel (sedan)

Panorama roof with power tilt/sliding panel (sedan)

Extending and retracting the roller sunblinds

The roller sunblinds only operate with the tilt/sliding panel closed. The front and rear roller sunblind cannot be operated individually.

**Warning!**

When extending the roller sunblinds, make sure no one is in danger of being injured by the extending procedure. The extending of the roller sunblinds can be immediately halted by releasing the switch.

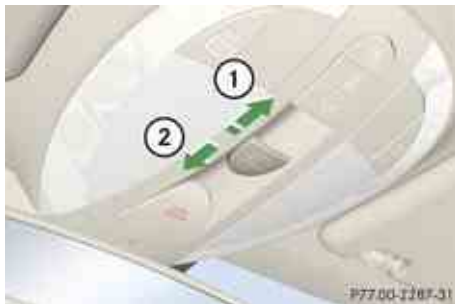

Roof panel switch

- ① Retracting
- ② Extending

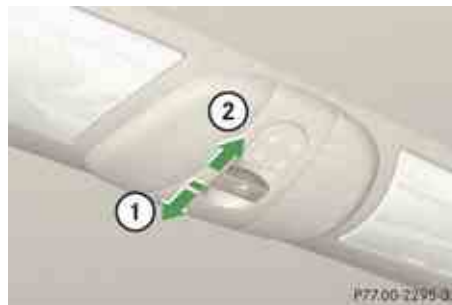

Roller sunblinds switch, rear

- ① Retracting
- ② Extending

- ▶ Switch on the ignition.
- ▶ **Retracting/Extending:** Move the roof panel switch to the resistance point in the required direction of arrow ① or ② until the roller sunblinds have reached their desired position.
- ▶ **Express retracting:** Push the roof panel switch past the resistance point in direction of arrow ① and release. The roller sunblinds retract completely.
- ▶ **Stopping during express retracting:** Move the roof panel switch in any direction.

Opening and closing the panorama roof with power tilt/sliding panel

**Warning!**

When opening or closing the tilt/sliding panel, make sure there is no danger of anyone being harmed by the opening/closing procedure.

The opening procedure of the tilt/sliding panel can be immediately halted by releasing the switch or, if the switch was moved past the resistance point and released, by moving the switch in any direction.

The closing procedure of the tilt/sliding panel can be immediately halted by releasing the switch.

**Warning!** Observe Safety notes, see page 62.

**Warning!**

The panorama roof with tilt/sliding panel is made out of glass. In the event of an accident, the glass may shatter. This may result in an opening in the roof.

In a vehicle rollover, occupants not wearing their seat belts or not wearing them properly may be thrown out of the opening.



### Panorama roof with power tilt/sliding panel (sedan)

Such an opening also presents a potential for injury for occupants wearing their seat belts properly as entire body parts or portions of them may protrude from the passenger compartment.

**!** To avoid damaging the seals, do not transport any objects with sharp edges which can stick out of the tilt/sliding panel. Do not open the tilt/sliding panel if there is snow or ice on the roof, as this could result in malfunctions.

**!** Please keep in mind that weather conditions can sometimes change rapidly. Make sure to close the tilt/sliding panel when leaving the vehicle. If water enters the vehicle interior, vehicle electronics could be damaged which is not covered by the Mercedes-Benz Limited Warranty.

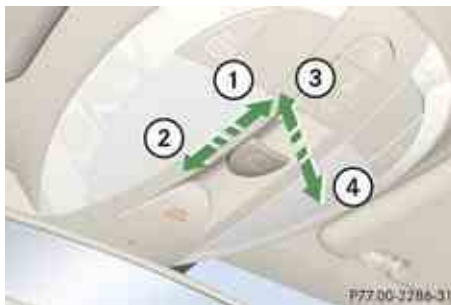

Roof panel switch

- ① Opening
- ② Closing
- ③ Raising
- ④ Lowering

The tilt/sliding panel only operates with the roller sunblinds retracted.

**i** You can also open or close the tilt/sliding panel using the SmartKey, see “Summer opening feature” (> page 122) or see “Convenience closing feature” (> page 123).

- ▶ Switch on the ignition.

### Opening

- ▶ **Opening manually:** Press and hold the roof panel switch to the resistance point in direction of arrow ①.
- ▶ Release the roof panel switch when the desired position is reached.
- ▶ **Express operation:** To open the tilt/sliding panel completely, press the roof panel switch past the resistance point in direction of arrow ① and release.
- ▶ **Stopping during express operation:** Move the roof panel switch in any direction.

**i** When the tilt/sliding panel is open, resonance noises may result in addition to the usual wind noises. They are caused by minimal pressure changes in the passenger compartment. To reduce or eliminate these noises, change the position of the tilt/sliding panel or open a window slightly.

### Raising

- ▶ Press and hold the roof panel switch to the resistance point in direction of arrow ③.
- ▶ Release the roof panel switch when the desired position is reached.



## Panorama roof with power tilt/sliding panel (sedan)

**Closing/Lowering**

- ▶ Move the roof panel switch to the resistance point in direction of arrow ② or ④.
- ▶ Release the roof panel switch when the desired position is reached.

**Synchronizing**

The tilt/sliding panel and roller sunblinds must be synchronized

- after the battery has been disconnected or discharged
- after a malfunction
- if the tilt/sliding panel does not open smoothly

**!** Do not attempt to open the tilt/sliding panel before the tilt/sliding panel is properly synchronized. The tilt/sliding panel could otherwise lock-up in the open position.

If the tilt/sliding panel cannot be closed or synchronized, contact an authorized Mercedes-Benz Center or call Roadside Assistance.

- ▶ Vehicles with SmartKey: Remove the SmartKey from the starter switch.
- ▶ Vehicles with KEYLESS-GO: Switch off the ignition and open the driver's door (this puts the starter switch in position **0**, same as with the SmartKey removed from the starter switch). The driver's door then can be closed again.
- ▶ Remove the respective fuse from the fuse box (▷ page 375).
- ▶ Reinsert the fuse in the fuse box.
- ▶ Switch on the ignition.
- ▶ Push and hold the roof panel switch in direction of arrow ③ (▷ page 198) until the roller sunblinds are fully extended.
- ▶ Keep holding the roof panel switch in direction of arrow ③ (▷ page 198) for approximately 1 second.
- ▶ Pull and hold the roof panel switch in direction of arrow ② (▷ page 198) until the roller sunblinds are fully retracted.
- ▶ Keep holding the roof panel switch in direction of arrow ② (▷ page 198) for approximately 1 second.
- ▶ Press and hold the roof panel switch in direction of arrow ① (▷ page 198) until the tilt/sliding panel is fully raised.
- ▶ Keep holding the roof panel switch in direction of arrow ① (▷ page 198) for approximately 1 second.
- ▶ Push and hold the roof panel switch in direction of arrow ③ (▷ page 198) until the tilt/sliding panel is fully closed.
- ▶ Keep holding the roof panel switch in direction of arrow ③ (▷ page 198) for approximately 1 second.
- ▶ Check the express operation feature of the tilt/sliding panel (▷ page 198). If the tilt/sliding panel opens completely, the roof is synchronized. Otherwise repeat the above steps.

## Loading and storing

### Loading and storing

#### Loading instructions

##### **Warning!**

Always fasten items being carried as securely as possible using cargo tie-down rings and fastening materials appropriate for the weight and size of the load.

In an accident, during hard braking or sudden maneuvers, loose items will be thrown around inside the vehicle and can cause injury to vehicle occupants unless the items are securely fastened in the vehicle.

To help avoid personal injury during a collision or sudden maneuver, exercise care when transporting cargo. Do not pile luggage or cargo higher than the seat backrests.

**Wagon:** The cargo compartment is the preferred place to carry objects. Always use cargo tie-down rings, and if so equipped, always use the cargo net when transporting cargo.

**Sedan:** The trunk is the preferred place to carry objects. Always use cargo tie-down

rings when transporting cargo. Do not place anything on the rear-window shelf.

Never drive vehicle with the trunk/cargo compartment open. Deadly carbon monoxide (CO) gases may enter vehicle interior resulting in unconsciousness and death.

#### Load distribution

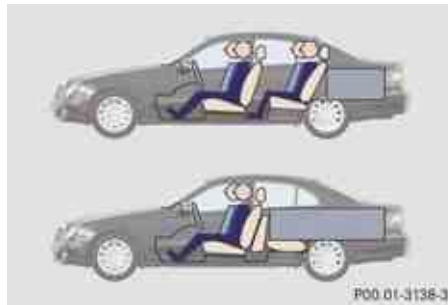

Sedan

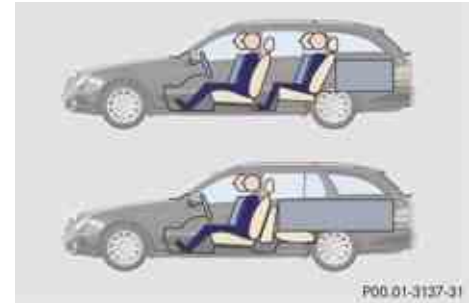

Wagon

The Gross Vehicle Weight (GVW) which is the weight of the vehicle including fuel, tools, spare wheel, installed accessories, passengers and luggage/cargo must never exceed the load limit and the Gross Vehicle Weight Rating (GVWR) for your vehicle as specified on the placard located on the driver's door B-pillar (> page 250).

In addition, the load must be distributed in such a way so that the weight on each axle never exceeds the Gross Axle Weight Rating (GAWR) for the front and rear axle. The GVWR and GAWR for your vehicle are indicated on the certification label located on the driver's door B-pillar (> page 250).

For more information, see "Tire and Loading Information" (> page 250).

The handling characteristics of a fully loaded vehicle depend greatly on the load distribution. It is therefore recommended to load the vehicle according to the illustration shown, with the heaviest items being placed towards the front of the vehicle.

Please pay attention to and comply with the following instructions when loading the vehicle and transporting cargo:

- **Sedan:** The trunk is the preferred place to carry objects. The enlarged cargo area should only be used for items which do not fit in the trunk alone.
- **Wagon:** The cargo compartment is the preferred place to carry objects. The expanded cargo compartment should only be used for items which do not fit in the cargo compartment alone.
- Always place items being carried against front or rear seat backrests, and fasten them as securely as possible.
- The heaviest portion of the cargo should always be kept as low as possible against front or rear seat backrests.

### Roof rack (sedan)

For information about further roof rack equipment, contact an authorized Mercedes-Benz Center.

#### **Warning!**

Only use roof racks approved by Mercedes-Benz for your vehicle model to avoid damage to the vehicle.

Follow the manufacturer's installation instructions. Otherwise, an improperly attached roof rack system or its load could become detached from the vehicle.

Do not exceed the maximum roof load of 220 lb (100 kg).

Take into consideration that when the roof rack is loaded, the handling characteristics are different from those when operating the vehicles without the roof rack loaded.

Make sure

- you can raise the tilt/sliding sunroof or tilt/sliding panel completely
- you can open the trunk completely

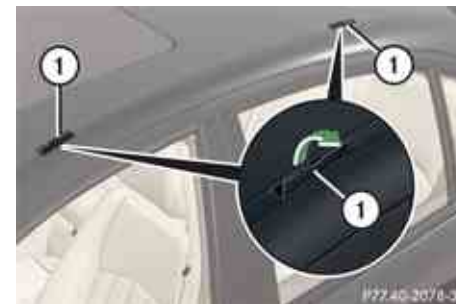

① Trim cover

- ▶ Flip trim covers ① open.
- ▶ Only attach the roof rack to the anchorage points under trim covers ①.
- ▶ Observe manufacturer's instructions for installation.

## Loading and storing

### Ski bag (sedan, Canada only)

#### **Warning!**

The ski bag is designed for up to four pairs of skis. Do not load the ski bag with other objects.

Always fasten the ski bag securely. In an accident, an unfastened ski bag can cause injury to vehicle occupants.

### Unfolding and loading

- ▶ Fold rear armrest down.



- ① Cover
- ② Catch

- ▶ Pull catches ② in direction of arrows.
- ▶ Open cover ① downwards in direction of the arrow.



- ③ Ski bag

- ▶ Pull ski bag ③ into passenger compartment and unfold.
- ▶ Open the trunk.



- ④ Button

- ▶ Press button ④.

The flap opens in direction of arrow.



- ▶ From trunk, slide skis into ski bag.

## Loading and storing



⑤ Strap

- ▶ Tighten strap ⑤ by pulling at the loose end (arrow) until the skis in the ski bag are tightly secured.

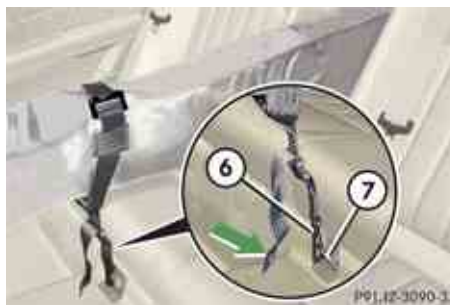

⑥ Hook

⑦ Eye

- ▶ Connect hook ⑥ of front strap to eye ⑦ located on center tunnel in front of rear seat bench.
- ▶ Tighten strap by pulling at the loose end (arrow).

### Unloading and folding

- ▶ Loosen both straps.
- ▶ Disconnect hook ⑥ from eye ⑦.
- ▶ Unload skis.
- ▶ Close flap in trunk.
- ▶ Fold and flatten ski bag lengthwise.
- ▶ Place folded ski bag inside recess of seat backrest.
- ▶ Close cover.

- ▶ Fold rear armrest up.

### Removing the ski bag

For ski bag removal, we recommend that you contact an authorized Mercedes-Benz Center.

#### **⚠ Warning!**

Never drive vehicle with trunk open while the ski bag is removed. Deadly carbon monoxide (CO) gases may enter vehicle interior, resulting in unconsciousness and death.

To prevent unauthorized persons from access to the trunk, always close the cover.

### Parcel net

#### **⚠ Warning!**

The parcel net is intended for storing lightweight items only, such as road maps, mail, etc.

Heavy objects, objects with sharp edges or fragile objects may not be transported in the parcel net. In an accident, during hard braking, or sudden maneuvers, they could be thrown around inside the vehicle and cause injury to vehicle occupants.



### Loading and storing

The parcel net cannot protect transported goods in the event of an accident.

A parcel net is located in the front passenger footwell.

### Cargo tie-down rings

Your vehicle is equipped with four cargo tie-down rings.

Carefully secure cargo by applying even load on all rings ① with rope of sufficient strength to hold down the cargo.

Always follow loading instructions (▷ page 200).

### Trunk/cargo compartment

The cargo tie-down rings are located in the trunk/cargo compartment.



Sedan

① Cargo tie-down ring

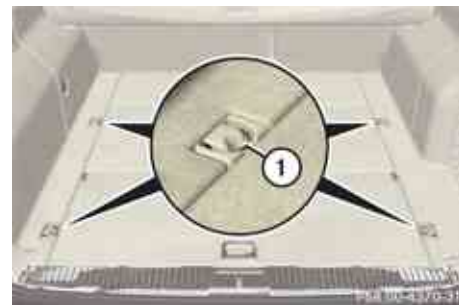

Wagon

① Cargo tie-down ring

### Hook (sedan)

A retaining hook can be used to attach cargo items such as bags.

## Loading and storing



- ① Tab
- ② Retaining hook

► Pull tab ① of retaining hook ② down.

**!** Do not use the retaining hook to tie down cargo.

## Expanding cargo volume

To expand the cargo volume, you can fold down the left and right seat backrests.

The two sections can be folded down separately to enlarge the cargo volume.

**⚠ Warning!**

When expanding the cargo volume, always fold the seat cushions fully forward.

Unless you are transporting cargo, the seat backrests must remain properly locked in the upright position.

In an accident, during hard braking or sudden maneuvers, loose items will be thrown around inside the vehicle, and cause injury to vehicle occupants unless the items are securely fastened in the vehicle.

Always use the cargo tie-down rings.

## Sedan

## Folding rear seat backrest forward

**!** Always release the seat cushion and fold it forward before folding the corresponding seat backrest forward. The seat backrest may otherwise be damaged.

It may be necessary to move these seats forward slightly in order to fold the seat backrests forward.

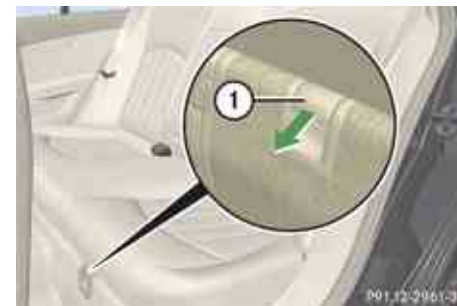

- ① Release handle

► Pull release handle ①.

The seat cushion springs slightly upward.

## Loading and storing



- ① Seat cushion
- ② Seat backrest

- ▶ Grab the back of seat cushion ① and fold forward.
- ▶ Push the rear seat head restraints all the way in.
- ▶ If the rear center seat is to be occupied while driving, it may be necessary to fold the seat belt buckle up again.



- ▶ Pull the handle in the trunk. Seat backrest ② is released and the head restraints fold back.
- ▶ Fold seat backrest ② forward.

**!** Make sure the head restraints fit all the way into the seat cushion pockets. This will prevent the seat backrests from being damaged during loading.

### Returning rear seat backrest to original position

#### **⚠ Warning!**

Always lock seat backrest in its upright position when rear seat bench is occupied, or the extended cargo volume is not in use. Check for secure locking by pushing and pulling on the seat backrest.

In an accident, during hard braking or sudden maneuvers, loose items will be thrown around inside the vehicle, and cause injury to vehicle occupants unless the items are securely fastened in the vehicle.

To help avoid personal injury during a collision or sudden maneuver, exercise care when transporting cargo.

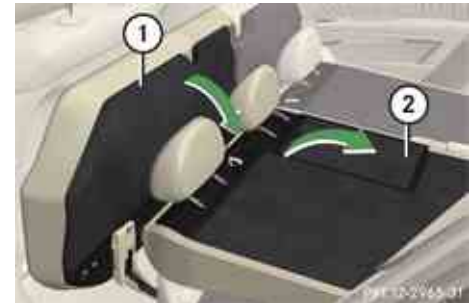

- ① Seat cushion
- ② Seat backrest

- ▶ Fold seat backrest ② rearward until it engages.



## Loading and storing

- ▶ Fold seat cushion ① rearward and press the center front of the cushion until it audibly engages.
- ▶ If need be, fold the head restraint forward by hand.

**Removing rear seat cushion**

Removing the rear seat cushions will provide you with a larger, flat cargo volume.

- ▶ Fold the seat cushions forward (> page 205).
- ▶ Remove the head restraints (> page 100).
- ▶ Fold the seat backrest into the vertical position.

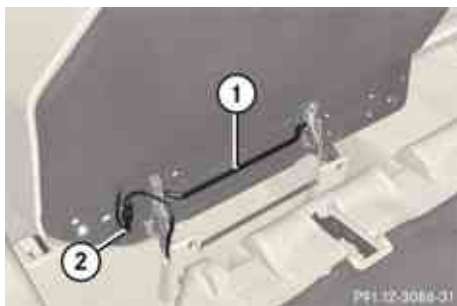

- ① Release lever
- ② Plug for rear seat heating (Canada only)

- ❗ Vehicles with rear seat heating (Canada only):  
The electrical contact on the bottom of the seat cushion must be disconnected before removing the rear seat cushion.

- ▶ Press the plug connection on the checkered surface and pull plug ② for the seat heating out of the seat cushion.

- ❗ Vehicles with rear seat heating (Canada only):  
When placing the seat cushion back in, guide the plug connection back together until the plug engages.

- ▶ Pull release lever ① and remove the seat cushion by pulling it upward.

- ❗ Leave the seat cushion hinge in this position. The upholstery could be damaged if you fold the hinge back.



- ▶ Fold the seat backrest forward.

**Wagon**

- ❗ To prevent damage, the following must be observed before folding the seat backrest forward:

- the head restraints must be folded back and fully inserted
- the front seat must be moved forward until sufficient clearance for folding procedure is achieved
- the seat cushions must be folded forward

## Loading and storing

### Folding rear seat backrest forward

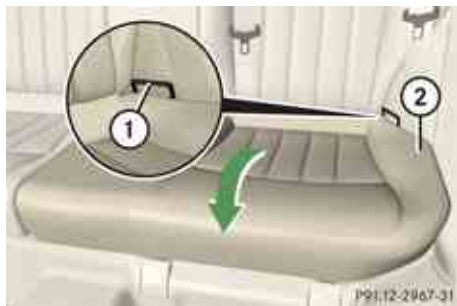

① Release catch

② Seat cushion

- ▶ Pull release catch ① and use it to pull seat cushion ② up.



③ Seat backrest

④ Release catch

- ▶ Pull release catch ④ up. Seat backrest ③ is released and the head restraints fold back.
- ▶ Fold seat backrest ③ forward.
- ▶ Adjust front seats to desired position.
- ▶ If the rear center seat is to be occupied while driving, it may be necessary to fold the seat belt buckle up again.

### Returning rear seat backrest to original position

#### **⚠ Warning!**

Always lock seat backrest in its upright position when rear seat bench is occupied, or the extended cargo compartment is not

in use. Check for secure locking by pushing and pulling on the seat backrest.

In an accident, during hard braking or sudden maneuvers, loose items will be thrown around inside the vehicle, and cause injury to vehicle occupants unless the items are securely fastened in the vehicle.

To help avoid personal injury during a collision or sudden maneuver, exercise care when transporting cargo.



① Seat cushion

② Seat backrest

- ▶ Fold seat backrest ② to the rear until it engages.

## Loading and storing

- ▶ Fold seat cushion ① to the rear and press the center front of the cushion until it audibly engages.
- ▶ If need be, fold the head restraint forward by hand.

### Adjusting rear seat backrest position

The seat backrests can be placed in an alternative upright position. This creates a larger cargo compartment area or provides for improved seating comfort on the folding bench seat, if required.



- ① Release catch
- ② Seat backrest
- ▶ Pull right seat release catch ① up and fold seat backrest ② forward.
- ▶ With seat backrest ② released, pull release catch ① up again.

- ▶ Pull left seat release catch ① up and fold seat backrest ② forward.
- ▶ With seat backrest ② released, pull release catch ① up again.
- ▶ Fold driver's-side rear seat backrest ② to the rear until it engages.
- ▶ Fold passenger-side seat backrest ② to the rear until it engages. The seat backrests are now in the alternative position.

### Removing rear seat cushion

Removing the rear seat cushions will provide you with a larger, flat cargo volume.

- ▶ Fold the seat cushions forward (▶ page 208).
- ▶ Remove the head restraints (▶ page 100).
- ▶ Fold the seat backrest into the vertical position.

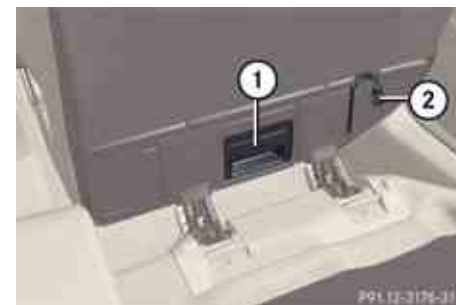

- ① Release lever
- ② Plug for rear seat heating (Canada only)

- ❗ Vehicles with rear seat heating (Canada only):  
The electrical contact on the bottom of the seat cushion must be disconnected before removing the rear seat cushion.
- ▶ Press the plug connection on the checkered surface and pull plug ② for the seat heating out of the seat cushion.
- ▶ Pull release lever ① and remove the seat cushion by pulling it upward.
- i Vehicles with rear seat heating (Canada only):

### Loading and storing

When placing the seat cushion back in, guide the plug connection back together until the plug engages.

- ❗ Leave the seat cushion hinge in this position. The upholstery could be damaged if you fold the hinge back.



- ▶ Fold the seat backrest forward.

### Cargo management system (wagon, Canada only)

The cargo management system and accompanying accessories enable you to utilize your cargo compartment in a variety of ways. You can store the cargo management system in the pouch that comes with the vehicle.

The pouch and telescoping rod can be placed in the storage box in the cargo compartment.

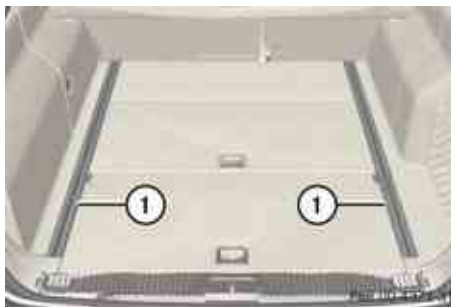

- ① Cargo rails

### Inserting the mounting elements into the cargo rails

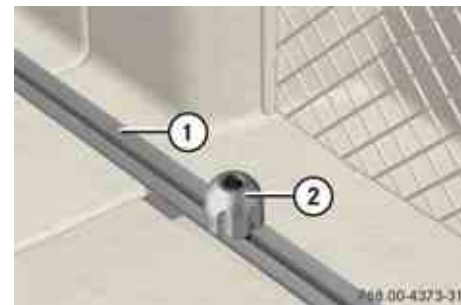



- ① Cargo rail
- ② Mounting element



You can move mounting element ② to various engaging points on cargo rail ① and fix it in place.



These engaging points are located 2 inches (5.1 cm) apart from one another on cargo rail ① and are indicated by markings.

You can turn the mounting element in the cargo rail to four positions:

-  To lock the mounting element
-  To insert or remove the cargo tie-down ring, the belt reel or the telescoping rod

Loading and storing

-  To insert or remove the mounting element
-  To move the mounting element to the next engaging point



- ▶ Turn mounting element ② to .
  - ▶ Insert mounting element ② in cargo rail ①.
  - ▶ Turn mounting element ② until it engages in position .
- You should be able to feel mounting element ② engage in cargo rail ①.

### Inserting the cargo tie-down ring in the mounting element

#### Warning!

The cargo tie-down rings should be subject to equal loads. Make sure to comply with the information provided in the loading instructions.





- ① Cargo tie-down ring
  - ② Mounting element
- ▶ Turn mounting element ② in the cargo rail to .
  - ▶ Insert cargo tie-down ring ① into mounting element ②.
  - ▶ Turn mounting element ② until it engages in position .
- You should be able to feel mounting element ② engage in the cargo rail.

### Belt reel

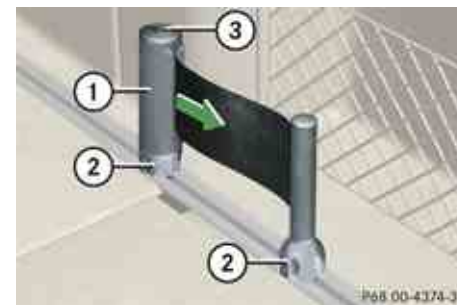
The belt reel can be used to tighten light-weight loads against the side wall of the cargo compartment, thus securing them from slipping.



- ① Belt reel
  - ② Mounting element
  - ③ Locking button
- ▶ Insert two mounting elements ② into a cargo rail.
  - ▶ Turn mounting element ② in the cargo rail to .
  - ▶ Insert belt reel ① into mounting element ②.
  - ▶ Turn mounting element ② in the cargo rail until it engages in position .
- You should be able to feel mounting element ② engage in the cargo rail.
- ▶ Press locking button ③ on belt reel ① and pull cargo belt out in direction of arrow.

### Loading and storing

- ▶ Place load between the cargo belt and the side wall of the cargo compartment.
- ▶ Press locking button ③ on belt reel ①. With the other hand, slowly pull cargo belt over load until the load is properly secured.

### Telescoping rod

The telescoping rod can be used to tighten the load against the rear seats so as to secure it from slipping.

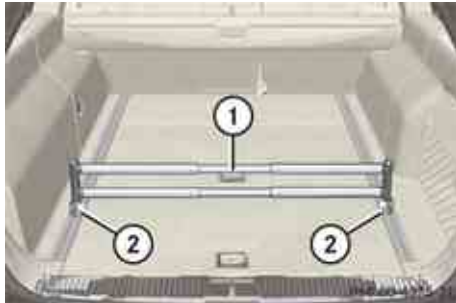

- ① Telescoping rod
- ② Mounting element

- ▶ Insert one mounting element ② into each cargo rail.
- ▶ Turn mounting element ② in the cargo rail to .

- ▶ Insert telescoping rod ① into mounting element ②.
- ▶ Turn mounting element ② in the cargo rail until it engages in position . You should be able to feel mounting element ② engage in the cargo rail.

### Storage box in cargo compartment (wagon, Canada only)

#### Warning!

When you are using the storage box in the cargo compartment, the seat backrests of the seats in front of it must be completely engaged to the rear, and the twin roller blind must be installed.

Do not exceed the storage box's maximum load of 44 lb (20 kg), as it could otherwise become detached during an accident or sharp braking maneuvers, and could injure you or other passengers.

The storage box in the cargo compartment is covered by the rear seat bench.



- ① Storage box
- ② Cargo compartment floor
- ③ Seat backrests
- ④ Locking hooks

- ▶ **Installing:** Fold seat backrests ③ forward (▷ page 207).
- ▶ Insert storage box ① from within the cargo compartment with the opening pointing in direction of travel.
- ▶ Press locking hooks ④ of storage box ① into the space between seat backrests ③ and cargo compartment floor ②.
- ▶ Fold seat backrests ③ to the original position (▷ page 208).

## Loading and storing

Storage box ① is additionally held in place from above by the twin roller blind.

- ▶ **Loading:** Fold seat backrests ③ forward (▷ page 207).
- ▶ Fill storage box ① with cargo through the opening on the front side.
- ▶ Fold seat backrests ③ to the original position (▷ page 208).
- ▶ **Removing:** Fold seat backrests ③ forward (▷ page 207).
- ▶ Slide locking hooks ④ of storage box ① forward out of the retainers.
- ▶ Pull storage box ① to the rear and remove it from cargo compartment.
- ▶ Fold seat backrest ③ to the original position (▷ page 208).

### Twin roller blind (wagon)

The twin roller blind contains a cargo net and a cargo compartment cover.

### Cargo net

#### **Warning!**

The cargo net cannot hold back heavy loads. The transported load should therefore always be tied down.

Objects which are insufficiently secured could otherwise injure you if they are thrown around in the event of an accident, during hard braking or steering maneuvers.

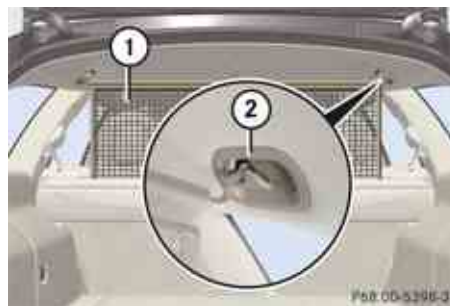

- ① Cargo net
- ② Mounting for cargo net

- ▶ Pull cargo net ① up and hook it onto mounting ②.

**i** You can use cargo net ① even when the seat backrest is folded forward. Cargo net ① should then be hooked onto the front mountings.

### Cargo compartment cover

To assist loading the cargo area when the cargo compartment cover is closed, the cover will be released and automatically raised/ lowered when opening/closing the tailgate.

**!** When loading the vehicle, make sure not to load the cargo compartment over the lower edge of the side windows. The twin roller blind could otherwise be damaged when the tailgate is being closed.



### Loading and storing



- ① Handle
- ② Cargo compartment cover

### Rolling up the cargo compartment cover

- ▶ Use handle ① to pull cargo compartment cover ② down into the horizontal position.
- ▶ Unhook cargo compartment cover ② from its anchorages on the left and right sides. To do so, pull cargo compartment cover ② slightly towards the rear and lower it.
- ▶ Slowly guide cargo compartment cover ② back until it stops.

### Pulling out the cargo compartment cover

- ▶ Pull out cargo compartment cover ② towards the rear until it engages.

### Removing the twin roller blind

- ▶ Roll up cargo net and cargo compartment cover ②.
- ▶ Fold both rear seat cushions forward (▷ page 207).
- ▶ Fold the passenger-side rear seat backrest forward (▷ page 207).
- ▶ Fold the driver's side rear seat backrest forward (▷ page 207).
- ▶ Push twin roller blind to the driver's side out of its anchorage on the seat backrest and remove it.

### Storage space under the cargo compartment floor (wagon, E 63 AMG only)

The vehicle tool kit and jack are stored under the rear cargo compartment floor. A loading tray and a folding box are located under the front cargo compartment floor.

### Opening the cargo compartment floor

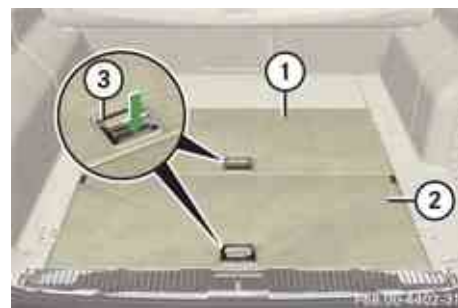

- ① Front cargo compartment floor
  - ② Rear cargo compartment floor
  - ③ Handle
- ▶ Use handle ③ to open cargo compartment floor ① or ②.



## Loading and storing

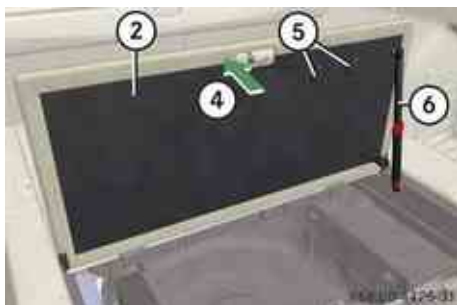

- ② Rear cargo compartment floor
- ④ Locking in place
- ⑤ Hooks
- ⑥ Pneumatic spring

- ▶ Press rear cargo compartment floor ② slightly forward ④. Pneumatic spring ⑥ engages, locking rear cargo compartment floor ② in place.

**i** You can transport objects when the cargo compartment floor is open and hang light luggage items from hooks ⑤.

### Closing the front cargo compartment floor

- ▶ Swing front cargo compartment floor ① downward.
- ▶ Push front cargo compartment floor ① downward on handle ③ until it locks into place.

### Closing the rear cargo compartment floor

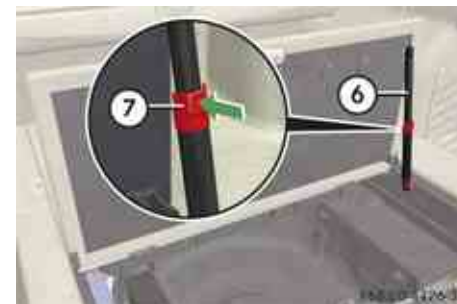

- ⑥ Pneumatic spring
- ⑦ Release button

- ▶ Press release button ⑦ and swing rear cargo compartment floor ② downward.
- ▶ Push front cargo compartment floor ① downward on handle ③ until it locks into place.

## Loading and storing

### Removing the rear cargo compartment floor



- ① Raising
  - ② Rear cargo compartment floor
  - ③ Retainer
  - ④ Moving out
  - ⑤ Pneumatic spring
  - ⑥ Release catch
- ▶ Open rear cargo compartment floor ② (▷ page 214).
  - ▶ Slide release catch ⑥ upward and remove pneumatic spring ⑤ from bolt by moving it to the left.
  - ▶ Press pneumatic spring ⑤ into retainer ③.

- ▶ Move rear cargo compartment floor ② into an almost vertical position (to an angle of 85°).

- ① Rear cargo compartment floor ② can only be moved upwards out of the lug at an angle of 85°.
- ▶ Grip the top of rear cargo compartment floor ②, raise left-hand side ① and move it to the left out of lug ④ on the right-hand side.

### Expanding the cargo compartment floor

- ▶ Remove rear cargo compartment floor ② (▷ page 216).
- ▶ Open front cargo compartment floor ①.

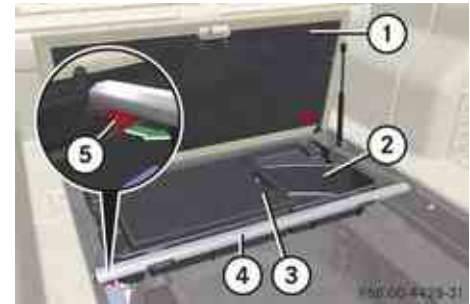

- ① Front cargo compartment floor
  - ② Loading tray
  - ③ Folding box
  - ④ Crossbar
  - ⑤ Release catch
- ▶ Remove loading tray ②.
  - ▶ Slide release catch ⑤ all the way to the right and press left side of crossbar ④ upward.
  - ▶ Pull crossbar ④ to the left away from the guide tab and remove it.

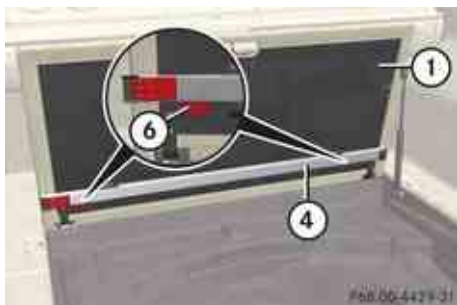

① Front cargo compartment floor

④ Crossbar

⑥ Retainer

- Store crossbar ④ in a suitable place. To do so, insert crossbar ④ into the two retainers ⑥ on front cargo compartment floor ①.

The two retainers ⑥ must be unlocked in order to remove crossbar ④. To do so, push the tabs at the bottom of retainer ⑥ forward.

- i** You can store loading tray ② under the rear or the front cargo compartment floor.

### Storage compartments

#### **⚠ Warning!**

To help avoid personal injury during a collision or sudden maneuver, exercise care when storing objects in the vehicle. Put luggage or cargo in the trunk/cargo compartment if possible.

Do not pile luggage or cargo higher than the seat backrests (wagon).

Do not place anything on the shelf below the rear window (sedan).

Parcel nets cannot secure hard or heavy objects.

Keep compartment lids closed. This will help to prevent stored objects from being thrown about and injuring vehicle occupants during

- braking
- vehicle maneuvers
- an accident

### Glove box

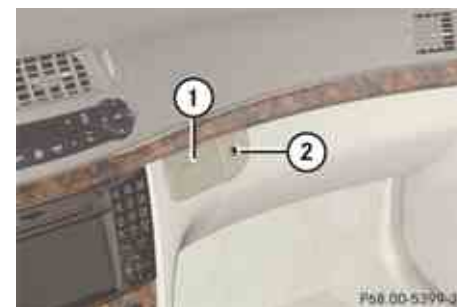

① Compartment for mobile phone/glasses

② Glove box lid release

- **Opening glove box:** Push glove box lid release ②.
- **Opening compartment:** Press on compartment ①.
- **Closing:** Close compartment ① first before closing the glove box.
- Push glove box lid up until it engages.

#### **Locking and unlocking the glove box separately**

You can lock the glove box separately, e.g. when the vehicle is in the shop for service.

The glove box can only be locked or unlocked with the mechanical key.



## Loading and storing



- 1 Unlocking glove box
- 2 Locking glove box

## Storage compartment in the rear center console



- Briefly press the top of the compartment.

## Storage compartment in the rear armrest



- **Opening:** Pull down the armrest.
- Press the handle upwards and fold the rear armrest lid up.

**!** Do not sit on or lean your body weight against the armrest when it is folded down, as you could otherwise damage it.

## Storage bags

### **⚠ Warning!**

Do not place objects with a combined weight of more than 4.4 lb (2 kg) into the storage bag. Otherwise, the Occupant Classification System OCS may not be able

to properly approximate the occupant weight category.

The storage bag is intended for storing light-weight items only.

Heavy objects, objects with sharp edges or fragile objects may not be transported in the storage bag. In an accident, during hard braking, or sudden maneuvers, they could be thrown around inside the vehicle and cause injury to vehicle occupants.

The storage bag cannot protect transported goods in the event of an accident.

Storage bags are located on the back of the front seats.

## Useful features

## Cup holders

**⚠ Warning!**

In order to help prevent spilling liquids on vehicle occupants and/or vehicle equipment, only use containers that fit into the cup holder. Use lids on open containers and do not fill containers to a height where the contents, especially hot liquids, could spill during braking, vehicle maneuvers, or in an accident. Liquids spilled on vehicle occupants may cause serious personal injury. Liquids spilled on vehicle equipment may cause damage not covered by the Mercedes-Benz Limited Warranty.

When not in use, keep the cup holder closed. An open cup holder may cause injury to you or others when contacted during braking, vehicle maneuvers, or in an accident.

Keep in mind that objects placed in the cup holder may come loose during braking, vehicle maneuvers, or in an accident and be thrown around in the vehicle interior. Objects thrown around in the vehicle interior may cause an accident and/or serious personal injury.



**Storage compartment with cup holder in the center armrest**

The storage compartment in the center armrest contains a removable cup holder.



① Cover

► **Opening:** Slide cover ① in direction of arrow.

❗ Roadside Assistance button  (► page 226) and Information button  (► page 227) are located below cover ①.



② Cup holder

③ Storage compartment

► **Closing:** Slide cover ① back.

❗ Cup holder ② can be removed to increase storage space and for cleaning.

## Useful features



- ① Cup holder
- ② Locking pins

▶ **Removing cup holder:** Depress locking pins ② and remove cup holder ① upwards.



- ③ Locking pins

- ▶ **Reinstalling cup holder:** Insert cup holder.
- ▶ Press both locking pins ③ outwards.

❗ Make sure the cup holder is correctly positioned in the guides while you are reinstalling it. Otherwise the cup holder can be damaged.

## Cup holder in rear armrest



- ▶ **Opening:** Briefly press the front of the rear armrest.
- ▶ **Closing:** Slide cup holder back until it engages.

❗ Do not sit on or lean your body weight against the armrest when it is folded down, as you could otherwise damage it.

❗ Close the cup holder before folding the armrest upwards. Otherwise you could damage the cup holder.

## Cup holder in third-row seat (wagon)



- ▶ **Opening:** Briefly press the front of the cup holder.
- ▶ Pull the cup holder until they engage.

### Sun visors

#### **Warning!**

Do not use the vanity mirror while driving. Keep the vanity mirrors in the sun visors closed while vehicle is in motion. Reflected glare can endanger you and others.

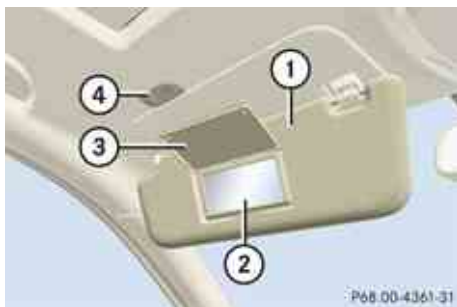

- ① Sun visor
- ② Vanity mirror
- ③ Vanity mirror cover
- ④ Vanity mirror lamp

### Glare through the windshield

- ▶ Flip sun visor ① down when you experience glare.

### Glare through a door window



- ⑤ Sun visor
  - ⑥ Additional visor
  - ⑦ Mounting
- ▶ Close vanity mirror cover ③ if opened.
  - ▶ Disengage sun visor ⑤ from mounting ⑦.
  - ▶ Pivot sun visor ⑤ to the side.
  - ▶ Adjust sun visor ⑤ by pushing or pulling in direction of arrows.
  - ▶ Flip down additional sun visor ⑥ when you experience additional glare through the windshield.

### Vanity mirror

The mirror lamp only functions when the sun visor is engaged in mounting.

- ▶ Flip sun visor ① down.
- ▶ Lift up vanity mirror cover ③. Vanity mirror lamp ④ comes on.

### Roller sunblind in the rear doors (Canada only)



- ① Tab
  - ② Holder
- ▶ **Extending:** Pull on tab ① and engage it in holder ②.
  - ▶ **Retracting:** Disengage tab ① from holder ② and guide retraction.



### Useful features

**!** Always guide the sunblind by hand. Do not let it snap back, as the retractor could be damaged.

#### Rear window sunshade (sedan)

##### **⚠ Warning!**

When operating the rear window sunshade make sure there is no danger of anyone being harmed by the extending or retracting procedure.

The extending or retracting procedure can be immediately halted by briefly pressing rear window sunshade switch. To reverse direction of movement, press rear window sunshade switch again.

**⚠ Observe Safety notes, see page 62.**



① Rear window sunshade switch

Always extend the sunshade fully for its support against the window frame.

- ▶ Switch on the ignition.
- ▶ **Extending/Retracting:** Press rear window sunshade switch ① briefly.

#### Ashtrays

##### Center console ashtray

##### **⚠ Warning!**

Remove front ashtray insert only with vehicle standing still.



- ① Cover
- ② Sliding knob

- ▶ **Opening:** Briefly press the marking on the bottom of cover ①.
- ▶ **Removing ashtray insert:** Secure vehicle from movement by engaging the parking brake.
- ▶ Shift the automatic transmission into neutral position **N**.
- ▶ Push sliding knob ② to the right and hold.



## Useful features

- ▶ Grab and remove ashtray insert from ashtray frame.
- ▶ **Reinstalling ashtray insert:** Push the ashtray insert back into the frame until it engages.
- ▶ **Closing:** Push down cover ①.

## Rear door ashtray



- ① Ashtray release
- ② Ashtray

- ▶ **Opening:** Briefly press the top of ashtray ②.
- ▶ **Removing ashtray insert:** Pull ashtray release ① in direction of arrow.
- ▶ Remove ashtray insert upwards from ashtray frame.

- ▶ **Reinstalling ashtray insert:** Push ashtray insert back into ashtray frame until it engages.
- ▶ **Closing:** Push the top of ashtray ②.

## Cigarette lighter

**⚠ Observe Safety notes, see page 62.**

**⚠ Warning!**

Never touch the heating element or sides of the lighter; they are extremely hot. Hold the knob only.

Make sure any children traveling with you do not injure themselves or start a fire with the hot cigarette lighter.

If the engine is off and the cigarette lighter is being used extensively, the vehicle battery may become discharged.



- ① Cigarette lighter

- ▶ Switch on the ignition.
- ▶ Open the cover (▶ page 222).
- ▶ Push in cigarette lighter ①. Cigarette lighter ① will pop out automatically when hot.
- ▶ Take out cigarette lighter ①.
- ▶ Reinsert cigarette lighter ① in its socket after use.

**!** The lighter socket can be used to accommodate 12V DC electrical accessories (up to a maximum of 85 W) designed for use with the standard “cigarette lighter” plug type. Keep in mind, however, that connecting accessories to the lighter socket (for example extensive connecting and disconnecting, or using



### Useful features

plugs that do not fit properly) can damage the lighter socket. With the socket damaged, the lighter may not function properly any longer.

#### Power outlets

The power outlets can be used to accommodate 12V DC electrical accessories (e.g. auxiliary lamps, mobile phone chargers) up to a maximum of 15 A (180 W).

An additional power outlet is located on the left side in the trunk/cargo compartment.

If the engine is off and the power outlets are being used extensively, the vehicle battery may become discharged.

- ▶ Switch on the ignition.



Rear center console

#### Tele Aid

**!** In order to activate the Tele Aid system, a subscriber agreement must be completed. To ensure your system is activated and operational, please press the  button to perform the acquaintance call. Failure to complete either of these steps may result in a system that is not activated.

If you have any questions regarding activation, please call the Response Center at 1-800-756-9018 (in the USA) or 1-888-923-8367 (in Canada).

Shortly after the completion of your Tele Aid acquaintance call, you will receive a user ID and password in the mail. You may use this

password to access the Tele Aid section in “Owner’s Online” at [www.mbUSA.com](http://www.mbUSA.com) (USA only). The “My Tele Aid” section will give you access to account information, remote door unlock and more.

The Tele Aid system is available if

- it has been activated and is operational. Activation requires a subscription for monitoring services, connection and cellular air time.
  - vehicle battery power is available.
  - the relevant cellular phone network and GPS signals are available and pass the information on to the Response Center.
- i** Location of the vehicle on a map is only possible if the vehicle is able to receive signals from the GPS satellite network and pass the information on to the Response Center.

#### The Tele Aid system

(Telematic Alarm Identification on Demand)

The Tele Aid system consists of three types of response:

- Automatic and manual emergency
- Roadside Assistance
- Information

The Tele Aid system is operational providing that the vehicle's battery is charged, properly connected, not damaged, and cellular and GPS coverage is available. The Tele Aid system utilizes the cellular network for communication and the GPS (Global Positioning System) satellites for vehicle location. If either of these signals are unavailable, the Tele Aid system may not function and if this occurs, assistance must be summoned by other means.

To adjust the speaker volume during a Tele Aid call do the following:

- ▶ Press button  or  on the multifunction steering wheel.



or

- ▶ Use the adjustment button on your COMAND system.

### System self-test

The system performs a self-test after you have switched on the ignition.

#### **Warning!**

If the indicator lamps in the SOS button, in the Roadside Assistance button  and/or in the Information button  do not come on during the system self-test, or if any of these indicators remain illuminated constantly in red and/or the message **Tele Aid Inoperative** is displayed in the multifunction display after the system self-test, a malfunction in the system has been detected.

If a malfunction is indicated as outlined above, the system may not operate as expected. In case of an emergency, help will have to be summoned by other means.

Have the system checked at the nearest Mercedes-Benz Center or contact the Response Center at 1-800-756-9018 (in the USA) or 1-888-923-8367 (in Canada) as soon as possible.

### Emergency calls

-  In order to activate the Tele Aid system, a subscriber agreement must be completed.

To ensure your system is activated and operational, please press the  button to perform the acquaintance call. Failure to complete either of these steps may result in a system that is not activated.

If you have any questions regarding activation, please call the Response Center at 1-800-756-9018 (in the USA) or 1-888-923-8367 (in Canada).

An emergency call is initiated automatically following an accident in which the Emergency Tensioning Devices (ETDs) or air bags deploy.

An emergency call can also be initiated manually (▷ page 226).

Once the emergency call is in progress, the indicator lamp in the SOS button will begin to flash. The message **Connecting Call** appears in the multifunction display and the audio system or the COMAND system is muted. When the connection is established, the message **Call Connected** appears in the multifunction display.

All information relevant to the emergency, such as the location of the vehicle (determined by the GPS satellite location system), vehicle model, identification number and color are generated.

A voice connection between the Response Center and the occupants of the vehicle will



## Useful features

be established automatically soon after the emergency call has been initiated. The Response Center will attempt to determine more precisely the nature of the emergency provided they can speak to an occupant of the vehicle.

- ❗ If no vehicle occupant responds, an ambulance will be sent to the vehicle immediately.

### ⚠ Warning!

If the indicator lamp in the SOS button is flashing continuously and there was no voice connection to the Response Center established, then the Tele Aid system could not initiate an emergency call (e.g. the relevant cellular phone network is not available).

The message *Call Failed* appears in the multifunction display for approximately 10 seconds.

Should this occur, assistance must be summoned by other means.

- ❗ The “911” emergency call system is a public service. Using it without due cause is a criminal offense.

## Initiating an emergency call manually

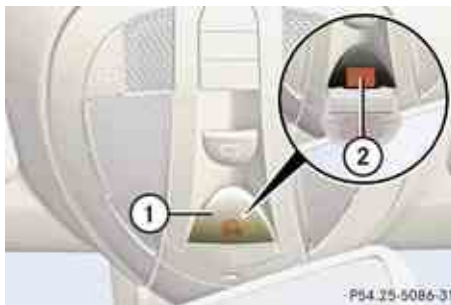

- ① Cover
- ② SOS button

- ▶ Briefly press on cover ① to open.
- ▶ Press SOS button ② briefly. The indicator lamp in SOS button ② will flash until the emergency call is concluded.
- ▶ Wait for a voice connection to the Response Center.
- ▶ Close cover ① after the emergency call is concluded.

### ⚠ Warning!

If you feel at any way in jeopardy when in the vehicle (e.g. smoke or fire in the vehicle, vehicle in a dangerous road location), please do not wait for voice contact after you have pressed the emergency button.

Carefully leave the vehicle and move to a safe location. The Response Center will automatically contact local emergency officials with the vehicle's approximate location if they receive an automatic SOS signal and cannot make voice contact with the vehicle occupants.

## Roadside Assistance button

- ▶ Open the storage compartment (> page 219).



- ① Roadside Assistance button 

- ▶ Press and hold button  for longer than 2 seconds. A call to a Mercedes-Benz Roadside Assistance dispatcher will be initiated. The indicator lamp in the Roadside Assistance

## Useful features

button  will flash while the call is in progress. The message **Connecting Call** will appear in the multifunction display and the audio system or the COMAND system is muted.

When the connection is established, the message **Call Connected** appears in the multifunction display. The Tele Aid system will transmit data generating the vehicle identification number, model, color and location (subject to availability of cellular and GPS signals).

**i** The COMAND system display indicates that a Tele Aid call is in progress. While the call is connected you can change to the navigation menu by pressing the NAV button on the COMAND system. Spoken commands are not available.

A voice connection between the Roadside Assistance dispatcher and the occupants of the vehicle will be established.

- ▶ Describe the nature of the need for assistance.

The Mercedes-Benz Roadside Assistance dispatcher will either dispatch a qualified Mercedes-Benz technician or arrange to tow your vehicle to the nearest authorized Mercedes-Benz Center. For services such as

labor and/or towing, charges may apply. Refer to the Roadside Assistance manual for more information.

The following is only available in the USA: Sign and Drive services: Services such as a jump start, a few gallons of fuel or the replacement of a flat tire with the vehicle spare tire are obtainable at no charge.

**1** If the indicator lamp in the Roadside Assistance button  is flashing continuously and there was no voice connection to the Response Center established, then the Tele Aid system could not initiate a Roadside Assistance call (e.g. the relevant cellular phone network is not available). The message **Call Failed** appears in the multifunction display.



- ▶ **Terminating calls:** Press button  on the multifunction steering wheel.
- or
- ▶ Press the respective button for ending a telephone call on the COMAND system.

### Information button

- ▶ Open the storage compartment (▶ page 219).



**1** Information button 

- ▶ Press and hold Information button  for longer than 2 seconds. A call to the Customer Assistance Center will be initiated. The indicator lamp in the Information button  will flash while the call is in progress. The message **Connecting Call** will appear in the multifunction display and the COMAND system is muted.

When the connection is established, the message **Call Connected** appears in the multifunction display. The Tele Aid system will transmit data generating the vehicle identification number, model, color and location (subject to availability of cellular and GPS signals).

## Useful features

**i** The COMAND system display indicates that a Tele Aid call is in progress. While the call is connected you can change to the navigation menu by pressing the NAV button on the COMAND system. Spoken commands are not available.

A voice connection between the Customer Assistance Center representative and the occupants of the vehicle will be established. Information regarding the operation of your vehicle, the nearest authorized Mercedes-Benz Center or Mercedes-Benz USA products and services is available to you.

For more details concerning the Tele Aid system, please visit [www.mbusa.com](http://www.mbusa.com) (USA only), log in to “Owner’s Online” and visit the “My Tele Aid” section to learn more.

**i** If the indicator lamp in the Information button  is flashing continuously and there was no voice connection to the Response Center established, then the Tele Aid system could not initiate an Information call (e.g. the relevant cellular phone network is not available). The message Call Failed appears in the multifunction display.

▶ **Terminating calls:** Press button  on the multifunction steering wheel.

or

▶ Press the respective button for ending a telephone call on the COMAND system.

## Call priority

If other service calls such as a Roadside Assistance call or Information call are active, an emergency call is still possible. In this case, the emergency call will take priority and override all other active calls.

The indicator lamp in the respective button flashes until the call is concluded. Emergency calls can only be terminated by a Response Center or Customer Assistance Center representative. All other calls can be terminated by pressing button  on the multifunction steering wheel or the respective button for ending a telephone call on the COMAND system.

**i** When a Tele Aid call has been initiated, the COMAND system audio is muted. The mobile phone is no longer connected to the COMAND system. If you must use this phone, we recommend that you use it only

with the vehicle at a standstill in a safe location.

## Destination Download to the COMAND system

**i** The components and operating principles of the COMAND system can be found in the separate COMAND operating instructions.

Destination Download allows you access to a database of over 10 million points of interest (POIs) that can be downloaded to your vehicle’s navigation system. If you know the destination, the address can be downloaded, or can be provided with points of interests near your location.

The Response Center can transmit destination data to the COMAND system during the connection with the Roadside Assistance or Customer Assistance Center.

The transmitted data can contain address details for a Mercedes-Benz Center or POIs.

### Route guidance

You will be prompted to confirm that route guidance to the entered address is to be started.

- ▶ Select Yes using button ◀ or ▶ on the COMAND system.
- ▶ Press button **OK** on the COMAND system to confirm.

The system calculates the route and subsequently starts the route guidance to the defined address.

- i** If you select No, you can save the address to your address book.
- i** The Destination Download feature is available if the relevant mobile phone network is available and data connection is possible.

### Search and Send

- i** In order to utilize Search & Send your vehicle must be equipped with Tele Aid, Navigation, and an active Tele Aid subscription.

“Search & Send” is a navigation destination address entry service. A destination address located using Google Maps® or Yahoo Local

Maps® website can be delivered via Tele Aid directly to the navigation system in your vehicle.

### Specify and Send a Destination Address

- i** Please refer to any specific instructions provided by either website regarding entering or sending an address. Each website functions differently and is subject to change.
- ▶ Go to **www.maps.google.com** or **www.maps.yahoo.com** and enter a destination address in the address entry field.
- ▶ Depending on which website you are using, click on the appropriate button to send the destination address to your Tele Aid account email address.
- ▶ Enter the email address you specified when you activated your Tele Aid account in the appropriate field when the “Send” dialog box appears.
- ▶ Click “Send”.

### Retrieve Destination Address

- ▶ Press the Tele Aid Information button to begin the download of the destination

address to your vehicle’s navigation system.



- i** If you have sent more than one destination address to your vehicle you must make one Information call for each destination address download.
- ▶ Select Yes when the message appears asking if you would like to start navigation. This will open the start navigation screen.



## Useful features



▶ Select Start.

or

▶ Select No if you wish to save the downloaded destination address in the From Memory destination list for future use.



**i** Destination addresses will download in the same order they were sent. If you have multiple Mercedes-Benz vehicles equipped with Tele Aid and active accounts, each destination address sent will be retrievable by all vehicles associated with the e-mail address you specified for your Tele Aid account.

### Remote door unlock

In case you have locked your vehicle unintentionally (e.g. SmartKey inside vehicle), and the reserve SmartKey is not available:

- ▶ Contact the Response Center at 1-800-756-9018 (in the USA) or 1-888-923-8367 (in Canada). You will be asked to provide your password.
- ▶ Then return to your vehicle at the time arranged with the Response Center and pull the trunk/tailgate recessed handle for a minimum of 20 seconds until the indicator lamp in the SOS button is flashing. The message *Connecting Call* appears in the multifunction display.

As an alternative, you may unlock the vehicle via Internet in the "My Tele Aid" section of "Owner's Online", using your ID and password (USA only).

The Response Center will then unlock your vehicle with the remote door unlocking feature.

**i** The remote door unlock feature is available if the relevant cellular phone network is available.

The SOS button will flash and the message *Call Connected* will appear in the multifunction display to indicate receipt of the door unlock command.

Once the vehicle is unlocked, a Response Center specialist will attempt to establish voice contact with the vehicle occupants. If the trunk/tailgate recessed handle was pulled for more than 20 seconds before door unlock authorization was received by the Response Center, you must wait 15 minutes before pulling the trunk/tailgate recessed handle again.



## Useful features

**Stolen Vehicle Recovery services**

In the event your vehicle was stolen:

- ▶ Report the incident to the police.  
The police will issue a numbered incident report.
- ▶ Pass this number on to the Response Center along with your password.  
The Response Center will then attempt to covertly contact the vehicle's Tele Aid system. Once the vehicle is located, the Response Center will contact the local law enforcement and you. The vehicle's location will only be provided to law enforcement.

**i** If the anti-theft alarm stays on for more than 30 seconds, a call to the Response Center is initiated automatically by the Tele Aid system provided Tele Aid service was subscribed to and properly activated, and that necessary cellular service and GPS coverage are available. See "Anti-theft alarm system" (▶ page 76).

**Garage door opener**

The integrated remote control can operate up to three separately controlled devices compatible with HomeLink® or some other systems.

**⚠ Warning!**

Before programming the integrated remote control to a garage door opener or gate operator, make sure people and objects are out of the way of the device to prevent potential harm or damage. When programming a garage door opener, the door moves up or down. When programming a gate operator, the gate opens or closes.

Do not use the integrated remote control with any garage door opener that lacks safety stop and reverse features as required by U.S. federal safety standards (this includes any garage door opener model manufactured before April 1, 1982). A garage door that cannot detect an object - signaling the door to stop and reverse - does not meet current U.S. federal safety standards.

When programming a garage door opener, park vehicle outside the garage.

Do not run the engine while programming the integrated remote control. Inhalation of exhaust gas is hazardous to your health. All exhaust gas contains carbon monoxide (CO), and inhaling it can cause unconsciousness and possible death.

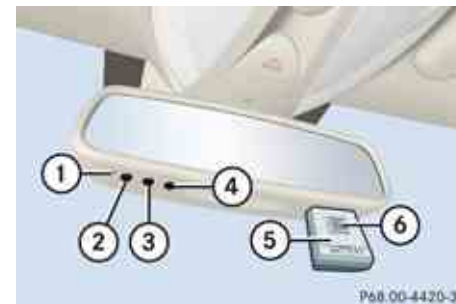

Interior rear view mirror with integrated remote control

- ① Indicator lamp
- ②③④ Signal transmitter button
- ⑤ Hand-held remote control (not part of vehicle equipment)
- ⑥ Hand-held remote control button

## Useful features

### Programming the integrated remote control

- ▶ **Step 1:** Switch on the ignition.
- ▶ **Step 2:** If you have previously programmed a signal transmitter button and wish to retain its programming, proceed to step 3.

or

- ▶ If you are programming the integrated remote control for the first time, press and hold the two outer signal transmitter buttons (2) and (4) and release them when indicator lamp (1) begins to flash after approximately 20 seconds.

Do not hold the button for longer than 30 seconds.

This procedure erases any previous settings for all three channels and initializes the memory. If you later wish to program a second and/or third hand-held transmitter to the remaining two signal transmitter buttons, do not repeat this step and begin directly with step 3.

- ▶ **Step 3:** Hold the end of hand-held remote control (5) of the device you wish to train approximately 2 to 12 in (5 to 30 cm) away from the signal transmitter button (2), (3) or (4) to be programmed, while keeping indicator lamp (1) in view.

- ▶ **Step 4:** Using both hands, simultaneously press hand-held remote control button (6) and the desired signal transmitter button (2), (3) or (4). Do not release the buttons until step 5 is completed. Indicator lamp (1) will flash, first slowly and then rapidly.

**i** Indicator lamp (1) flashes immediately the first time the signal transmitter button is programmed. If this button has already been programmed, the indicator lamp will start flashing after 20 seconds.

- ▶ **Step 5:** After indicator lamp (1) changes from a slow to a rapidly flashing light, release the hand-held remote control button and the signal transmitter button.

- ▶ **Step 6:** Press and hold the just-trained signal transmitter button (2), (3) or (4) and observe indicator lamp (1).  
If indicator lamp (1) stays on constantly, programming is complete and your device should activate when the respective signal transmitter button (2), (3) or (4) is pressed and released.

- i** If indicator lamp (1) flashes rapidly for approximately 2 seconds and then turns to a constant light, continue with

programming steps 8 through 12 as your garage door opener may be equipped with the “rolling code” feature.

- ▶ **Step 7:** To program the remaining two signal transmitter buttons, repeat the steps above starting with step 3.

### Rolling code programming

To train a garage door opener (or other rolling code devices) with the rolling code feature, follow these instructions after completing the “Programming” portion (steps 1 through 6) of this text. A second person may make the following training procedures quicker and easier.

- ▶ **Step 8:** Locate the “training” button on the garage door opener motor head unit.

**i** Exact location and color of the button may vary by garage door opener brand. Depending on manufacturer, the “training” button may also be referred to as “learn” or “smart” button. If there is difficulty locating the transmitting button, refer to the garage door opener Operator’s Manual.

- ▶ **Step 9:** Press the “training” button on the garage door opener motor head unit. The “training light” is activated.

You have 30 seconds to initiate the following two steps.

- ▶ **Step 10:** Return to the vehicle and firmly press, hold for 2 seconds and release the programmed signal transmitter button (②, ③ or ④).
  - ▶ **Step 11:** Press, hold for 2 seconds and release same signal transmitter button a second time to complete the training process.
- i** Some garage door openers (or other rolling code equipped devices) may require you to press, hold for 2 seconds and release the same signal transmitter button a third time to complete the training process.
- ▶ **Step 12:** Confirm the garage door operation by pressing the programmed signal transmitter button (②, ③ or ④).
  - ▶ **Step 13:** To program the remaining two signal transmitter buttons, repeat the steps above starting with step 3.

### Gate operator/Canadian programming

Canadian radio-frequency laws require transmitter signals to “time-out” (or quit) after several seconds of transmission which may not be long enough for the integrated

signal transmitter to pick up the signal during programming. Similar to this Canadian law, some U.S. gate operators are designed to “time-out” in the same manner.

If you live in Canada or if you are having difficulties programming a gate operator (regardless of where you live) by using the programming procedures, replace step 4 with the following:

- ▶ **Step 4:** Press and hold the signal transmitter button (②, ③ or ④). Do not release this button until it has been successfully trained.
- ▶ While still holding down the signal transmitter button (②, ③ or ④), “cycle” your hand-held remote control button ⑥ as follows: Press and hold button ⑥ for 2 seconds, then release it for 2 seconds, and again press and hold it for 2 seconds. Repeat this sequence on the hand-held remote control until the frequency signal has been learned. Upon successful training, indicator lamp ① will flash slowly and then rapidly after several seconds.
- ▶ Proceed with programming step 5 and step 6 to complete.

- i** Upon completion of programming the integrated remote control, make sure you retain the hand-held remote control that came with the garage door opener, gate operator or other device. You may need it for use in other vehicles, for future programming of an integrated remote control, or simply for continued use as a hand-held remote control to operate the respective device in other situations.

### Reprogramming a single signal transmitter button

To program a device using a signal transmitter button previously trained, follow these steps:

- ▶ Switch on the ignition.
- ▶ Press and hold the desired signal transmitter button (②, ③ or ④). Do not release the button. Indicator lamp ① will begin to flash after 20 seconds.
- ▶ Without releasing the signal transmitter button, proceed with programming starting with step 3.

## Useful features

### Operation of integrated remote control

- ▶ Switch on the ignition.
- ▶ Select and press the appropriate integrated signal transmitter button (②, ③ or ④) to activate the remote controlled device.  
The integrated remote control transmitter continues to send the signal as long as the button is pressed – up to 20 seconds.

### Erasing the integrated remote control memory

- i** If you sell your vehicle, erase the codes of all three channels.
- ▶ Switch on the ignition.
- ▶ Simultaneously press and hold outer signal transmitter buttons ② and ④, for approximately 20 seconds, until indicator lamp ① flashes rapidly. Do not hold for longer than 30 seconds.  
The codes of all three channels are erased.

### Programming tips

If you are having difficulty programming the integrated remote control, here are some helpful tips:

- Check the frequency of hand-held remote control ⑤ (typically located on the reverse side of the remote). The integrated remote control is compatible with radio-frequency devices operating between 280-390 MHz.
- Put a new battery in hand-held remote control ⑤. This will increase the likelihood of the hand-held remote control sending a faster and more accurate signal to the integrated remote control.
- While performing step 3, hold hand-held remote control ⑤ at different lengths and angles from the signal transmitter button (②, ③ or ④) you are programming. Attempt varying angles at the distance of 2 to 12 inches (5 to 30 cm) away or the same angle at varying distances.
- If another hand-held remote control is available for the same device, try the programming steps again using that other hand-held remote control. Make sure new

batteries are in the hand-held remote control before beginning the procedure.

- Straighten the antenna wire from the garage door opener assembly. This may help improve transmitting and/or receiving signals.
- i** Certain types of garage door openers are incompatible with the integrated remote control. If you should experience further difficulties with programming the integrated remote control, contact an authorized Mercedes-Benz Center, or call the Mercedes-Benz Customer Assistance Center (in the USA) at 1-800-FOR-MERCEdes, or Customer Service (in Canada) at 1-800-387-0100.
- i** USA only:  
This device complies with Part 15 of the FCC Rules. Operation is subject to the following two conditions:
  1. This device may not cause harmful interference, and
  2. this device must accept any interference received, including interference that may cause undesired operation.

## Useful features

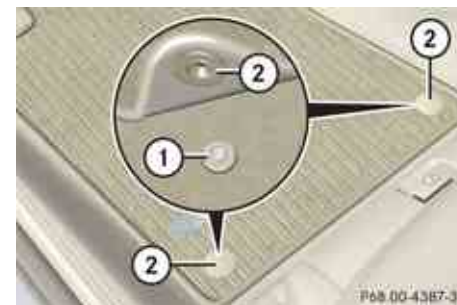

① Retainer pin

② Eyelet

► **Removing:** Pull floormat off of retainer pins ①.

► **Installing:** Press floormat eyelets ② onto retainer pins ①.

Any unauthorized modification to this device could void the user's authority to operate the equipment.

**i** Canada only:

This device complies with RSS-210 of Industry Canada. Operation is subject to the following two conditions:

1. This device may not cause interference, and
2. this device must accept any interference received, including interference that may cause undesired operation of the device.

Any unauthorized modification to this device could void the user's authority to operate the equipment.

### Floormats

**⚠ Warning!**

Whenever you are using floormats, make sure there is enough clearance and that the floormats are securely fastened.

Floormats should always be securely fastened using the fastening equipment.

Before driving off, check that the floormats are securely in place and adjust them if necessary. A loose floormat could slip and hinder proper functioning of the pedals.

Do not place several floormats on top of each other as this may impair pedal movement.

- i** To install or remove the floormat more easily, move the driver's seat or front passenger seat as far to the rear as possible.



**Vehicle equipment ..... 238**  
**The first 1000 miles (1500 km) ..... 238**  
**At the gas station ..... 239**  
**Engine compartment ..... 241**  
**Tires and wheels ..... 247**  
**Winter driving ..... 272**  
**Driving instructions ..... 274**  
**Maintenance ..... 280**  
**Vehicle care ..... 282**



## The first 1000 miles (1500 km)

### Vehicle equipment

**i** This Operator's Manual describes all features, standard or optional, potentially available for your vehicle at the time of purchase. Please be aware that your vehicle might not be equipped with all features described in this manual.

### The first 1000 miles (1500 km)

The more cautiously you treat your vehicle during the break-in period, the more satisfied you will be with its performance later on.

- Drive your vehicle during the first 1000 miles (1500 km) at varying but moderate vehicle and engine speeds.
- During this period, avoid heavy loads (full throttle driving) and excessive engine speeds (no more than  $\frac{2}{3}$  of maximum rpm in each gear).
- Select **C** as the preferred shift program (▷ page 133) for the first 1000 miles (1500 km).
- Avoid accelerating by kickdown.
- Do not attempt to slow the vehicle down by shifting to a lower gear using the gear selector lever.
- Select gear ranges **3**, **2** or **1** (▷ page 133) only when driving at moderate speeds (for hill driving).

After 1000 miles (1500 km) you may gradually increase vehicle and engine speeds to the permissible maximum.

**!** Additional instructions for AMG vehicles:

- During the first 1000 miles (1500 km), do not exceed a speed of 85 mph (140 km/h).
- During this period, avoid engine speeds above 4500 rpm in each gear.
- Shift gears in a timely manner.

All of the above instructions, as may apply to your vehicle type, also apply when driving the first 1000 miles (1500 km) after the engine or the rear differential has been replaced.

**i** Always obey applicable speed limits.

### Notes on breaking-in the rear differential (AMG vehicles only)

The vehicle is equipped with a self-locking rear differential. For increased protection of the rear differential, carry out an oil change after a break-in phase of 2000 miles (3000 km). This oil change will extend the useful life of the differential. Have the oil change carried out at a qualified specialist workshop. Mercedes-Benz recommends you have this work done at an authorized Mercedes-Benz Center.



## At the gas station

## At the gas station

## Refueling

 **Warning!**

Gasoline and diesel fuels are highly flammable and poisonous. They burn violently and can cause serious injury.

Never allow sparks, flames or smoking materials near gasoline or diesel fuel!

Turn off the engine before refueling.

Whenever you are around gasoline or diesel fuel, avoid inhaling fumes and any skin or clothing contact. Extinguish all smoking materials.

Direct skin contact with fuels and the inhalation of fuel vapors are damaging your health.

 **Warning!**

Overfilling of the fuel tank may create pressure in the system which could cause a gas discharge. This could cause the gas to spray back out when removing the fuel pump nozzle, which could cause personal injury.

 **Warning!**

Do not fill diesel tanks with gasoline. Do not mix diesel fuel with gasoline. Otherwise the fuel system and engine could be damaged. In addition, the vehicle could catch fire.

 Never use diesel fuel in vehicles with gasoline engine. Never refuel vehicles with gasoline engine with diesel fuel. Even small amounts of incorrect fuel will damage the fuel system and engine. Damage resulting from the use of non-approved fuels or fuel additives or resulting from mixing gasoline with diesel fuel or vice versa is not covered by the Mercedes-Benz Limited Warranty.

 If you have accidentally filled the tank with incorrect or non-approved fuel, do not switch on the ignition. Otherwise the incorrect or non-approved fuel will get into the fuel lines. The fuel system must be drained completely. Contact an authorized Mercedes-Benz Center to have the fuel system drained completely.

 Gasoline engine:

To prevent damage to the catalytic converters, only use premium unleaded gasoline in this vehicle.

Any noticeable irregularities in engine operation should be repaired promptly. Otherwise, excessive unburned fuel may reach the catalytic converter, causing it to overheat and potentially start a fire.

 Diesel engine:

When filling the diesel fuel tank using fuel containers, place a filling filter, a suede cloth or a clean flannel cloth as a filter. Otherwise, particles from the fuel container could clog the fuel lines and/or the diesel injection system.

 Diesel engine:

The engine is more susceptible to wear and damage if you use

- marine diesel fuel
- heating oil
- additives

The exhaust aftertreatment device will be seriously damaged if you use any other diesel fuel than ULTRA-LOW SULFUR HIGHWAY DIESEL FUEL (15 ppm SULFUR MAXIMUM).

The use of such non-approved fuels and/or special additives is not covered by the Mercedes-Benz Limited Warranty.

## At the gas station

### **i** Gasoline engine:

Only use premium unleaded gasoline with a minimum Posted Octane Rating of 91 (average of 96 RON/86 MON).

Information on gasoline quality can normally be found on the fuel pump. Please contact gas station personnel in case labels on the pump cannot be found.

For more information on gasoline, see “Premium unleaded gasoline (gasoline engine)” (▷ page 398), see “Fuel requirements” (▷ page 399), or contact an authorized Mercedes-Benz Center, or visit [www.mbusa.com](http://www.mbusa.com) (USA only).

### **i** Diesel engine:

Only use commercially available vehicular ULTRA-LOW SULFUR DIESEL FUEL (15 ppm SULFUR MAXIMUM). Information on diesel quality can normally be found on the fuel pump. Please contact gas station personnel in case labels on the pump cannot be found.

For more information on diesel fuels, see “Fuel requirements” (▷ page 399), or contact an authorized Mercedes-Benz Center, or visit [www.mbusa.com](http://www.mbusa.com) (USA only).

### **i** Diesel engine:

If you have driven the vehicle until the tank is empty, the fuel system needs to be bled (▷ page 366).

The fuel filler flap is located on the right-hand side of the vehicle towards the rear.

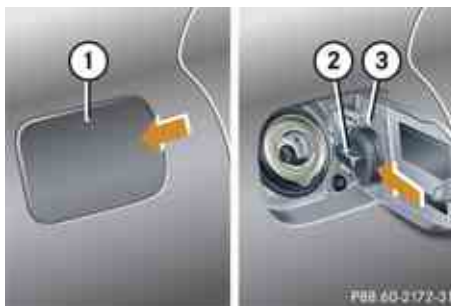

Locking/unlocking the vehicle with the SmartKey automatically locks/unlocks the fuel filler flap.

**i** In case the central locking system does not release the fuel filler flap, or the opening mechanism is clamping, contact Roadside Assistance or an authorized Mercedes-Benz Center.



- ① Fuel filler flap
- ② Fuel filler cap
- ③ Holder

▶ Turn off the engine.

**i** Leaving the engine running and the fuel filler cap open can cause the yellow fuel tank reserve warning lamp to flash and the malfunction indicator lamp  (USA only) or  (Canada only) to illuminate. For more information, see also “Practical hints” (▷ page 338).

▶ Remove the SmartKey from the starter switch.

KEYLESS-GO: Open the driver’s door (this puts the starter switch in position **0**, same as with the SmartKey removed from the starter switch). The driver’s door then can be closed again.

- ▶ **Opening:** Press fuel filler flap ① at the point indicated by the arrow.
- ▶ Turn fuel filler cap ② counterclockwise.
- ▶ Take off fuel filler cap ②.
- ▶ Place fuel filler cap ② in direction of arrow into holder ③.
- ▶ Fully insert filler nozzle unit and refuel.
- ▶ Only fill your tank until the filler nozzle unit cuts out – **do not top off or overfill.**

## Engine compartment

- ▶ **Closing:** Turn fuel filler cap ② clockwise until it audibly engages.
- ▶ Close fuel filler flap ①.

### Low outside temperatures (diesel engine)

**!** Do not fill the tank with gasoline. Do not blend diesel fuel with gasoline or kerosene. The fuel system and engine will otherwise be damaged, which is not covered by the Mercedes-Benz Limited Warranty.

To prevent malfunctions, diesel fuel with improved cold flow characteristics is offered in the winter months. Check with your fuel retailer.

### Check regularly and before a long trip

For information on quantities and requirements of operating agents, see “Fuels, coolants, lubricants, etc.” (▷ page 394).

Check the following:

- Engine oil level (▷ page 243)
- Tire inflation pressure (▷ page 255)
- Coolant level (▷ page 245)
- Vehicle lighting (▷ page 348)
- Washer system and headlamp cleaning system (▷ page 246)
- Brake fluid (▷ page 276), (▷ page 312), (▷ page 331)

### Engine compartment

#### Hood

#### **⚠ Warning!**

Do not pull the release lever while the vehicle is in motion. Otherwise the hood could be forced open by passing air flow. This could cause the hood to come loose and injure you and/or others.

#### Opening

#### **⚠ Warning!**

If you see flames or smoke coming from the engine compartment, or if the coolant temperature indicator indicates that the engine is overheated, do not open the hood. Move away from vehicle and do not open the hood until the engine has cooled. If necessary, call the fire department.

#### **⚠ Warning!**

You could be injured when the hood is open – even when the engine is turned off. Parts of the engine can become very hot. To prevent burns, let the engine cool off completely before touching any components on the vehicle. Comply with all relevant safety precautions.

## Engine compartment

### **⚠ Warning!**

To help prevent personal injury, stay clear of moving parts when the hood is open and the engine is running.

The radiator fan may continue to run for approximately 30 seconds or may even restart after the engine has been turned off. Stay clear of fan blades.

### **⚠ Warning!**

Vehicles with gasoline engine:

The engine is equipped with a transistorized ignition system. Because of the high voltage it is dangerous to touch any components (ignition coils, spark plug sockets, diagnostic socket) of the ignition system

- with the engine running
- while starting the engine
- when the ignition is switched on and the engine is turned manually

### **⚠ Warning!**

Vehicles with diesel engine:

The engine is equipped with a high-voltage electronic control unit for the injection system. Because of the high voltage it is dangerous to touch any components of the injection system (injectors, electrical wires)

- with the engine running
- while starting the engine
- when the ignition is switched on



① Hood lock release lever

- ▶ Pull release lever ①.  
The hood is unlocked.

**!** To avoid damage to the windshield wipers or hood, never open the hood if the wiper arms are folded forward away from the windshield.



② Handle

**!** To avoid damage to the handle never pull up the hood on the handle.

- ▶ Pull handle ② to its stop out of radiator grille.
- ▶ Pull up on hood.  
The hood will be automatically held open at shoulder height by gas-filled struts.

## Engine compartment

## Closing

**⚠ Warning!**

When closing the hood, use extreme caution not to catch hands or fingers. Be careful that you do not close the hood on anyone.

Make sure the hood is securely engaged before driving off. Do not continue driving if the hood can no longer engage after an accident, for example. The hood could otherwise come loose while the vehicle is in motion and injure you and/or others.

- ▶ Let the hood drop from a height of approximately 1 ft (30 cm).
- ▶ Check to make sure the hood is fully closed.

If you can raise the hood at a point above the headlamps, then it is not properly closed. Open it again and let it drop with somewhat greater force.

## Engine oil

The amount of oil your engine needs will depend on a number of factors, including driving style. Increased oil consumption can occur when the vehicle is new or the vehicle is driven frequently at higher engine speeds. Engine oil consumption checks should only be made after the vehicle break-in period.

- ❗ Do not use any special lubricant additives, as these may damage the drive assemblies. Using special additives not approved by Mercedes-Benz may cause damage not covered by the Mercedes-Benz Limited Warranty.
- For further information contact an authorized Mercedes-Benz Center.

## Notes on checking engine oil level

When checking the oil level the vehicle must be parked on level ground and the vehicle must have been stationary for at least 5 minutes with the engine turned off.

## Checking engine oil level

- ▶ Open the hood (▶ page 241).



- ① Oil dipstick
  - ② Upper (max) mark
  - ③ Lower (min) mark
- ▶ Pull out oil dipstick ①.
  - ▶ Wipe oil dipstick ① clean.
  - ▶ Fully insert oil dipstick ① into the dipstick guide tube.
  - ▶ Pull out oil dipstick ① again after approximately 3 seconds to obtain accurate reading.
- The oil level is correct when it is between lower (min) mark ③ and upper (max) mark ② of oil dipstick ①.

- ❗ All models (except E 63 AMG):



## Engine compartment

The filling quantity between the upper and lower marks on the oil dipstick is approximately 2.1 US qt. (2.0 l).

E 63 AMG:

The filling quantity between the upper and lower marks on the oil dipstick is approximately 1.6 US qt. (1.5 l).

► If necessary, add engine oil.

For more information on engine oil, see “Fuels, coolants, lubricants etc.” (► page 394).

For information on messages in the multifunction display concerning engine oil, see the “Practical hints” section (► page 322).

### Adding engine oil

**!** Only use approved engine oils and oil filters required for vehicles with Maintenance System. For a listing of approved engine oils and oil filters, contact an authorized Mercedes-Benz Center or visit [www.mbusa.com](http://www.mbusa.com) (USA only).

Using engine oils and oil filters of specification other than those expressly required for the Maintenance System, or changing of oil and oil filter at change intervals longer than those called for by the

Maintenance System will result in engine or emission control system damage not covered by the Mercedes-Benz Limited Warranty.



E 350/E 550 (E 320 BlueTEC similar)

① Filler cap



E 63 AMG

① Filler cap

► Unscrew filler cap ① from filler neck.

► Add engine oil as required. Be careful not to overfill with oil.

Be careful not to spill any oil when adding. Avoid environmental damage caused by oil entering the ground or water.

**!** Excess oil must be siphoned or drained off. It could cause damage to the engine and emission control system not covered by the Mercedes-Benz Limited Warranty.

► Screw filler cap ① back on filler neck.

For more information on engine oil, see the “Technical data” section and (► page 397).

## Engine compartment

## Transmission fluid level

The transmission fluid level does not need to be checked. If you notice transmission fluid loss or gearshifting malfunctions, have an authorized Mercedes-Benz Center check the transmission.

## Coolant level

The engine coolant is a mixture of water and anticorrosion/antifreeze.

When checking the coolant level, the vehicle must be parked on level ground, and the coolant temperature must be below 158°F (70°C).

**⚠ Warning!**

In order to avoid any potentially serious burns:

- Use extreme caution when opening the hood if there are any signs of steam or coolant leaking from the cooling system, or if the coolant temperature indicator indicates that the coolant is overheated.
- Do not remove pressure cap on coolant reservoir if coolant temperature is above 158°F (70°C). Allow engine to cool down before removing cap. The coolant

reservoir contains hot fluid and is under pressure.

- Using a rag, slowly open the cap approximately  $1/2$  turn to relieve excess pressure. If opened immediately, scalding hot fluid and steam will be blown out under pressure.
- Do not spill antifreeze on hot engine parts. Antifreeze contains ethylene glycol which may burn if it comes into contact with hot engine parts.

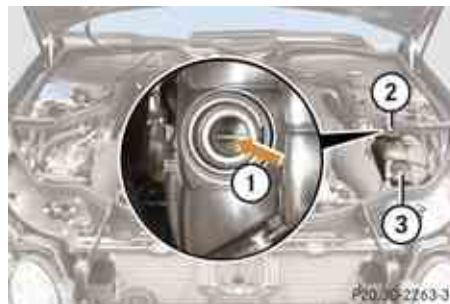

- ① Marking bar in the expansion tank
- ② Cap
- ③ Coolant expansion tank

- ▶ Using a rag, turn cap ② slowly approximately  $1/2$  turn counterclockwise to release any excess pressure.
- ▶ Continue turning cap ② counterclockwise and remove it.

The coolant level is correct if the level

- for cold coolant: reaches marking bar ① in coolant expansion tank ③
- for warm coolant: is approximately 0.6 in (1.5 cm) higher

- ▶ Add coolant as required.
- ▶ Replace and tighten cap ②.

For more information on coolant, see the “Technical data” section (▶ page 396) and (▶ page 400).

## Engine compartment

### Washer system and headlamp cleaning system

#### **Warning!**

Washer solvent/antifreeze is highly flammable. Do not spill washer solvent/antifreeze on hot engine parts, because it may ignite and burn. You could be seriously burned.

**!** Always use washer solvent/antifreeze where temperatures may fall below freezing point. Failure to do so could result in damage to the washer system/fluid reservoir.

**!** Only use washer fluid which is suitable for plastic lenses. Improper washer fluid can damage the plastic lenses of the headlamps.

**!** Do not use distilled or deionized water in the washer fluid reservoir. Otherwise, the washer fluid level sensor could be damaged.



① Cap for washer fluid reservoir

Fluid for the washer system, the rear window washer system (wagon only) and the headlamp cleaning system is supplied from the washer fluid reservoir.

During all seasons, add MB Windshield Washer Concentrate “MB SummerFit” to water. Premix the washer fluid in a suitable container.

- ▶ **Opening washer fluid reservoir:** Pull tab of cap ① upwards.
- ▶ Refill the washer fluid reservoir with MB Windshield Washer Concentrate “MB SummerFit” and water (or commercially available premixed washer solvent/

antifreeze, depending on ambient temperatures) (▷ page 402).

- ▶ **Closing washer fluid reservoir:** Press cap ① onto filler hole until it engages.

For more information, see “Washer system and headlamp cleaning system” (▷ page 397).



## Tires and wheels

## Tires and wheels

## Safety notes

Contact an authorized Mercedes-Benz Center for information on tested and recommended rims and tires for summer and winter operation. They can also offer advice concerning tire service and purchase.

 **Warning!**

Replace rims or tires with the same designation, manufacturer and type as shown on the original part. For further information contact an authorized Mercedes-Benz Center. If incorrectly sized rims and tires are mounted, the wheel brakes or suspension components can be damaged. Also, the correct operating clearance of the wheels and the tires may no longer be correct.

 **Warning!**

Worn, old tires can cause accidents. If the tire tread is worn to minimum tread depth, or if the tires have sustained damage, replace them.

When replacing rims, only use genuine Mercedes-Benz wheel bolts specified for the particular rim type. Failure to do so can

result in the bolts loosening and possibly an accident.

Retreaded tires are not tested or recommended by Mercedes-Benz, since previous damage cannot always be recognized on retreads. The operating safety of the vehicle cannot be assured when such tires are used.

 **Warning!**

If you feel a sudden significant vibration or ride disturbance, or you suspect that possible damage to your vehicle has occurred, you should turn on the hazard warning flashers, carefully slow down, and drive with caution to an area which is a safe distance from the road.

Inspect the tires and the vehicle underbody for possible damage. If the vehicle or tires appear unsafe, have the vehicle towed to the nearest authorized Mercedes-Benz Center or tire dealer for repairs.

 **Warning!**

Do not drive with a flat tire. A flat tire affects the ability to steer or brake the vehicle. You could lose control of the vehicle. Continued driving with a flat tire or driving at high

speed with a flat tire will cause excessive heat build-up and possibly a fire.

## Important guidelines

- Only use sets of tires and rims of the same type and make.
- Tires must be of the correct size for the rim.
- Break in new tires for approximately 60 miles (100 km) at moderate speeds.
- Regularly check the tires and rims for damage. Dented or bent rims can cause tire inflation pressure loss and damage to the tire beads.
- If vehicle is heavily loaded, check tire inflation pressure and correct as required.
- Do not allow your tires to wear down too far. Adhesion properties on wet roads are sharply reduced at tread depths of less than  $\frac{1}{8}$  in (3 mm).
- When replacing individual tires, you should mount new tires on the front wheels first (on vehicles with same-sized wheels all around).

## Tires and wheels

### Tire care and maintenance

#### **Warning!**

Regularly check the tires for damage. Damaged tires can cause tire inflation pressure loss. As a result, you could lose control of your vehicle.

Worn, old tires can cause accidents. If the tire tread is worn to minimum tread depth, or if the tires have sustained damage, replace them.

Check the tire inflation pressure at least every other week. For more information on checking tire inflation pressure, see “Recommended tire inflation pressure” (▷ page 253).

### Tire inspection

Every time you check the tire inflation pressure, you should also inspect your tires for the following:

- excessive treadwear (▷ page 248)
- cord or fabric showing through the tire’s rubber
- bumps, bulges, cuts, cracks or splits in the tread or side of the tire

Replace the tire if you find any of the above conditions.

Make sure you also inspect the spare tire periodically for condition and inflation. Spare tires will age and become worn over time even if never used, and thus should be inspected and replaced when necessary.

### Life of tire

#### **Warning!**

Tires and spare tire should be replaced after 6 years, regardless of the remaining tread.

The service life of a tire is dependent upon varying factors including but not limited to:

- Driving style
- Tire inflation pressure
- Distance driven

### Tread depth

#### **Warning!**

Although the applicable federal motor vehicle safety laws consider a tire to be worn when the treadwear indicators (TWI) become visible at approximately  $\frac{1}{16}$  in

(1.6 mm), we recommend that you do not allow your tires to wear down to that level. As tread depth approaches  $\frac{1}{8}$  in (3 mm), the adhesion properties on a wet road are sharply reduced.

Depending upon the weather and/or road surface (conditions), the tire traction varies widely.

Do not allow your tires to wear down too far. Adhesion properties on wet roads are sharply reduced at tread depths of less than  $\frac{1}{8}$  in (3 mm).

Treadwear indicators (TWI) are required by law. These indicators are located in six places on the tread circumference and become visible at a tread depth of approximately  $\frac{1}{16}$  in (1.6 mm), at which point the tire is considered worn and should be replaced.

The recommended minimum tire tread depth for summer tires is  $\frac{1}{8}$  in (3 mm). The recommended minimum tire tread depth for winter tires is  $\frac{1}{6}$  in (4 mm).

## Tires and wheels

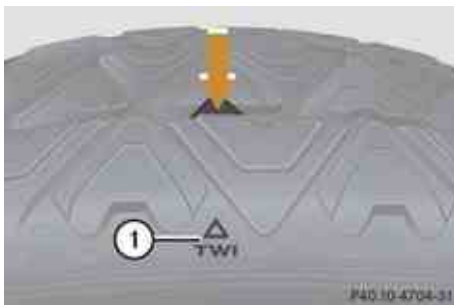

## ① TWI (Tread Wear Indicator)

The treadwear indicator appears as a solid band across the tread.

### Storing tires

**!** Keep unmounted tires in a cool, dry place with as little exposure to light as possible. Protect tires from contact with oil, grease and fuels.

### Cleaning tires

**!** Never use a round nozzle to power wash tires. The intense jet of water can result in damage to the tire.

Always replace a damaged tire.

### Direction of rotation

Unidirectional tires offer added advantages, such as better hydroplaning performance. To benefit, however, you must make sure the tires rotate in the direction specified.

An arrow on the sidewall indicates the intended direction of rotation (spinning) of the tire.

Spare wheels may be mounted against the direction of rotation (spinning) even with a unidirectional tire for temporary use only until the regular drive wheel has been repaired or replaced. Always observe and follow applicable temporary use restrictions and speed limitations indicated on the spare wheel.

### Loading the vehicle

Two labels on your vehicle show how much weight it may properly carry.

- (1) The Tire and Loading Information placard can be found on the driver's door B-pillar. This placard tells you important information about the number of people that can be in the vehicle and the total weight that can be carried in the vehicle. It also contains information on the proper size and recommended tire inflation pressures for the original equipment tires on your vehicle.
- (2) The certification label, also found on the driver's door B-pillar. It tells you about the gross weight capacity of your vehicle, called the Gross Vehicle Weight Rating (GVWR). The GVWR includes the weight of the vehicle, all occupants, fuel and cargo. The certification label also tells you about the front and rear axle weight capacity, called the Gross Axle Weight Rating (GAWR).

The GAWR is the total allowable weight that can be carried by a single axle (front or rear). Never exceed the GVWR or GAWR for either the front axle or rear axle.

## Tires and wheels



### ① Driver's door B-pillar

Following is a discussion on how to work with the information contained on the Tire and Loading Information placard with regards to loading your vehicle.

## Tire and Loading Information

### **⚠ Warning!**

Do not overload the tires by exceeding the specified load limit as indicated on the Tire and Loading Information placard on the driver's door B-pillar. Overloading the tires can overheat them, possibly causing a blowout. Overloading the tires can also result in handling or steering problems, or brake failure.

## Tire and Loading Information placard

① Data shown on Tire and Loading Information placard example are for illustration purposes only. Load limit data are specific to each vehicle and may vary from data shown in the following illustration. Refer to Tire and Loading Information placard on vehicle for actual data specific to your vehicle.

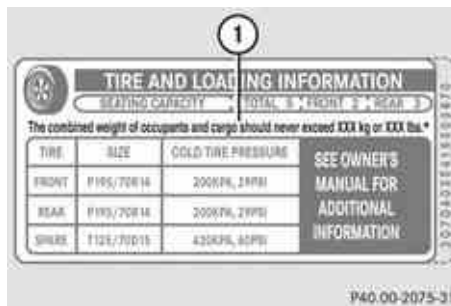

① Load limit information on the Tire and Loading Information placard

The Tire and Loading Information placard showing the load limit information is located on the driver's door B-pillar (▷ page 250).

▶ Locate the statement "The combined weight of occupants and cargo should never exceed XXX kilograms or XXX lbs."

on the Tire and Loading Information placard.

The combined weight of all occupants, cargo/luggage and trailer tongue load (if applicable) should never exceed the weight referenced in that statement.

## Seating capacity

The seating capacity gives you important information on the number of occupants that can be in the vehicle. Observe front and rear seating capacity. The Tire and Loading Information placard showing the seating capacity is located on the driver's door B-pillar (▷ page 250).

① Data shown on Tire and Loading Information placard example are for illustration purposes only. Seating capacity data are specific to each vehicle and may vary from data shown in the following illustration. Refer to Tire and Loading Information placard on vehicle for actual data specific to your vehicle.

## Tires and wheels

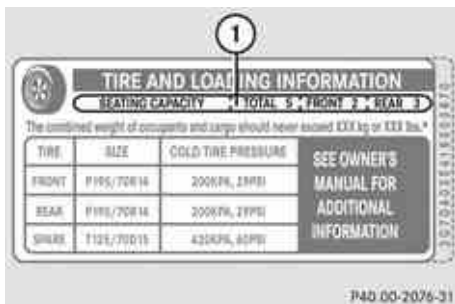

- ① Seating capacity information on the Tire and Loading Information placard

### Steps for determining correct load limit

The following steps have been developed as required of all manufacturers under Title 49, Code of U.S. Federal Regulations, Part 575 pursuant to the “National Traffic and Motor Vehicle Safety Act of 1966”.

- ▶ **Step 1:** Locate the statement “The combined weight of occupants and cargo should never exceed XXX kg or XXX lbs.” on your vehicle’s Tire and Loading Information placard.
  - ▶ **Step 2:** Determine the combined weight of the driver and passengers that will be riding in your vehicle.
  - ▶ **Step 3:** Subtract the combined weight of the driver and passengers from XXX kilograms or XXX lbs.
  - ▶ **Step 4:** The resulting figure equals the available amount of cargo and luggage load capacity. For example, if the “XXX” amount equals 1 400 lbs and there will be five 150 lbs passengers in your vehicle, the amount of available cargo and luggage load capacity is 650 lbs ( $1\ 400 - 750 (5 \times 150) = 650$  lbs).
  - ▶ **Step 5:** Determine the combined weight of luggage and cargo being loaded on the vehicle. That weight may not safely exceed the available cargo and luggage load capacity calculated in step 4.
  - ▶ **Step 6 (if applicable):** If your vehicle will be towing a trailer, load from your trailer will be transferred to your vehicle. Consult this manual to determine how this reduces the available cargo and luggage load capacity of your vehicle (▷ page 253).
- The following table shows examples on how to calculate total and cargo load capacities with varying seating configurations and number and size of occupants. The following examples use a load limit of 1 500 lbs. **This is for illustration purposes only.** Make sure you are using the actual load limit for your vehicle stated on the vehicle’s Tire and Loading Information placard (▷ page 250).

## Tires and wheels

Example	Combined weight limit of occupants and cargo from Tire and Loading Information placard	Number of occupants (driver and passengers)	Seating configuration	Occupants weight	Combined weight of all occupants	Available cargo/luggage and trailer tongue weight (total load limit from Tire and Loading Information placard minus combined weight of all occupants)
1	1 500 lbs	5	front: 2 rear: 3	Occupant 1: 150 lbs Occupant 2: 180 lbs Occupant 3: 160 lbs Occupant 4: 140 lbs Occupant 5: 120 lbs	750 lbs	1 500 lbs - 750 lbs = 750 lbs
2	1 500 lbs	3	front: 1 rear: 2	Occupant 1: 200 lbs Occupant 2: 190 lbs Occupant 3: 150 lbs	540 lbs	1 500 lbs - 540 lbs = 960 lbs
3	1 500 lbs	1	front: 1	Occupant 1: 150 lbs	150 lbs	1 500 lbs - 150 lbs = 1 350 lbs

The higher the weight of all occupants, the less cargo and luggage load capacity is available.

For more information, see “Trailer tongue load” (▷ page 253).

### Certification label

Even after careful determination of the combined weight of all occupants, cargo and the trailer tongue load (if applicable)

(▷ page 253) as to not exceed the permissible load limit, you must make sure your vehicle never exceeds the Gross Vehicle Weight Rating (GVWR) and the Gross Axle Weight Rating (GAWR) for either the front or rear axle. You can obtain the GVWR and GAWR from the certification label. The certification label can be found on the driver’s door B-pillar, see the “Technical data” section (▷ page 379).

**Gross Vehicle Weight Rating (GVWR):** The total weight of the vehicle, all occupants, all cargo, and the trailer tongue load (if applicable) must never exceed the GVWR.

**Gross Axle Weight Rating (GAWR):** The total allowable weight that can be carried by a single axle (front or rear).

To assure that your vehicle does not exceed the maximum permissible weight limits (GVWR and GAWR for front and rear axle),

## Tires and wheels

have the loaded vehicle (including driver, passengers and all cargo and, if applicable, trailer fully loaded) weighed on a suitable commercial scale.

### Trailer tongue load

The tongue load of any trailer is an important weight to measure because it affects the load you can carry in your vehicle. If a trailer is towed, the tongue load must be added to the weight of all occupants riding and any cargo you are carrying in the vehicle. The tongue load typically is 10% of the trailer weight and everything loaded in it.

Your Mercedes-Benz has been designed primarily to carry passengers and their cargo. Mercedes-Benz does not recommend trailer towing with your vehicle.

### Recommended tire inflation pressure

#### **Warning!**

Follow recommended tire inflation pressures.

Do not underinflate tires. Underinflated tires wear excessively and/or unevenly, adversely affect handling and fuel economy, and are more likely to fail from being overheated.

Do not overinflate tires. Overinflated tires can adversely affect handling and ride comfort, wear unevenly, increase stopping distance, and result in sudden deflation (blowout) because they are more likely to become punctured or damaged by road debris, potholes etc.

Do not overload the tires by exceeding the specified load limit as indicated on the Tire and Loading Information placard on the driver's door B-pillar. Overloading the tires can overheat them, possibly causing a blowout. Overloading the tires can also result in handling or steering problems, or brake failure.

Your vehicle is equipped with the Tire and Loading Information placard located on the driver's door B-pillar (▷ page 249).

The tire inflation pressure should be checked regularly and should only be adjusted on cold tires. The tires can be considered cold if the vehicle has been parked for at least 3 hours or driven less than 1 mile (1.6 km).

Follow recommended cold tire inflation pressures listed on Tire and Loading Information placard on the driver's door B-pillar.

Keeping the tires properly inflated provides the best handling, tread life and riding comfort.

In addition to the Tire and Loading Information placard on the driver's door B-pillar, also consult the tire inflation pressure label (if available) on the inside of the filler flap for any additional information pertaining to special driving situations. For more information, see "Important notes on tire inflation pressure" (▷ page 254).

 Data shown on Tire and Loading Information placard example are for illustration purposes only. Tire data are specific to each vehicle and may vary from data shown in the following illustration. Refer to Tire and Loading Information placard on vehicle for actual data specific to your vehicle.

## Tires and wheels

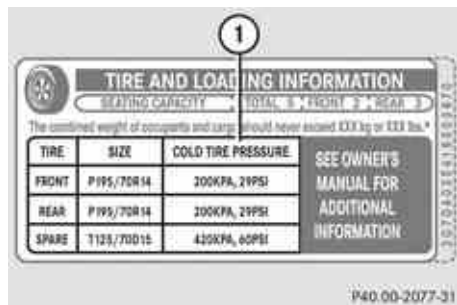

- ① Tire and Loading Information placard with recommended cold tire inflation pressures

The Tire and Loading Information placard lists the recommended cold tire inflation pressures for maximum loaded vehicle weight. The tire inflation pressures listed apply to the tires installed as original equipment.

### Important notes on tire inflation pressure

#### **Warning!**

If the tire inflation pressure drops repeatedly, check the tires for punctures from foreign objects and/or whether air is

leaking from the valves or from around the rim.

Tire temperature and tire inflation pressure are also increased while driving, depending on the driving speed and the tire load.

If you will be driving your vehicle at high speeds of 100 mph (160 km/h) or higher, where it is legal and conditions allow, consult the tire inflation pressure label on the inside of the fuel filler flap (if available) on how to adjust the cold tire inflation pressure. If you do not adjust the tire inflation pressure, excessive heat can build up and result in sudden tire failure.

If your vehicle is not equipped with the tire inflation pressure label on the inside of the fuel filler flap, contact an authorized Mercedes-Benz Center for proper tire inflation pressure.

- ① Driving comfort may be reduced when the tire inflation pressure is adjusted to the value for speeds above 100 mph (160 km/h) as specified on the tire inflation pressure label located on the inside of the fuel filler flap.

Make sure to readjust the tire inflation pressure for normal driving speeds. You

should wait until the tires are cold before adjusting the tire inflation pressure.

Some vehicles may have supplemental tire inflation pressure information for vehicle loads less than the maximum loaded vehicle condition. If such information is provided, it can be found on the tire inflation pressure label located on the inside of the fuel filler flap.

Tire inflation pressure changes by approximately 1.5 psi (0.1 bar) per 18°F (10°C) of air temperature change. Keep this in mind when checking tire inflation pressure where the temperature is different from the outside temperature.

### Potential problems associated with underinflated and overinflated tires

#### Underinflated tires

#### **Warning!**

Follow recommended tire inflation pressures.

Do not underinflate tires. Underinflated tires wear excessively and/or unevenly, adversely affect handling and fuel economy, and are more likely to fail from being overheated.



## Tires and wheels

Underinflated tires can

- cause excessive and uneven tire wear
- adversely affect fuel economy
- lead to tire failure from being overheated
- adversely affect handling characteristics

### Overinflated tires

#### Warning!

Follow recommended tire inflation pressures.

Do not overinflate tires. Overinflated tires can adversely affect handling and ride comfort, wear unevenly, increase stopping distance, and result in sudden deflation (blowout) because they are more likely to become punctured or damaged by road debris, potholes etc.

Overinflated tires can

- adversely affect handling characteristics
- cause uneven tire wear
- be more prone to damage from road hazards
- adversely affect ride comfort
- increase stopping distance

### Checking tire inflation pressure

#### Safety notes

#### Warning!

Follow recommended tire inflation pressures.

Do not underinflate tires. Underinflated tires wear excessively and/or unevenly, adversely affect handling and fuel economy, and are more likely to fail from being overheated.

Do not overinflate tires. Overinflated tires can adversely affect handling and ride comfort, wear unevenly, increase stopping distance, and result in sudden deflation (blowout) because they are more likely to become punctured or damaged by road debris, potholes etc.

Do not overload the tires by exceeding the specified load limit as indicated on the Tire and Loading Information placard on the driver's door B-pillar. Overloading the tires can overheat them, possibly causing a blowout. Overloading the tires can also result in handling or steering problems, or brake failure.

Check the tire inflation pressure at least every other week.

Check and adjust the tire inflation pressure when the tires are cold. The tires can be considered cold if the vehicle has been parked for at least 3 hours or driven less than 1 mile (1.6 km).

If you check the tire inflation pressure when the tires are warm (the vehicle has been driven for several miles or sitting less than 3 hours), the reading will be approximately 4 psi (0.3 bar) higher than the cold reading. This is normal. Do not let air out to match the specified cold tire inflation pressure. Otherwise, the tire will be underinflated.

### Checking tire inflation pressure manually

Follow the steps below to achieve correct tire inflation pressure:

- ▶ Remove the cap from the valve on one tire.
- ▶ Firmly press a tire gauge onto the valve.
- ▶ Read the tire inflation pressure on the tire gauge and check against the recommended tire inflation pressure on the Tire and Loading Information placard on the driver's door B-pillar (▶ page 250). If necessary, add air to achieve the recommended tire inflation pressure.
- ▶ If you have overfilled the tire, release tire inflation pressure by pushing the metal



## Tires and wheels

stem of the valve with e.g. a tip of a pen. Then recheck the tire inflation pressure with the tire gauge.

- ▶ Install the valve cap.
- ▶ Repeat this procedure for each tire.

### Run Flat Indicator (Canada only)

While the vehicle is being driven, the Run Flat Indicator monitors the set tire inflation pressures by evaluating each wheel's rotational speed. This allows the system to detect a significant loss of pressure in a tire. If a wheel's rotational speed changes due to falling tire inflation pressure, you will see a corresponding warning message in the multifunction display.

The Run Flat Indicator may function in a restricted manner or with a delay

- when snow chains are mounted to the vehicle
- in the presence of ice and snow
- when you are driving on a loose surface (e.g. sand or gravel)
- when you are driving in a very sporty manner (involving rapid acceleration or high speeds in curves)

### **Warning!**

When the multifunction display shows the message **Tire Pressure Check Tires**, one or more of your tires are significantly underinflated. You should stop and check your tires as soon as possible, and inflate them to the proper tire inflation pressure as indicated on the vehicle's Tire and Loading Information placard or, if available, on the tire inflation pressure label.

Driving on a significantly underinflated tire causes the tire to overheat and can lead to tire failure. Underinflation also reduces fuel efficiency and tire tread life, and may affect the vehicle's handling and stopping ability.

Each tire, including the spare, should be checked every other week when cold and set to the recommended tire inflation pressure as specified on the Tire and Loading Information placard on the driver's door B-pillar or, if available, on the tire inflation pressure label located on the inside of the fuel filler flap.

-  The recommended tire inflation pressures for your vehicle can be found on the Tire and Loading Information placard located on the driver's door B-pillar (▶ page 250) or, if available, on the tire inflation pressure

label on the on the inside of the fuel filler flap. The tire inflation pressures are not listed in the Operator's Manual.

### **Warning!**

The Run Flat Indicator does not provide a warning for wrongly selected tire inflation pressures. Always adjust tire inflation pressure according to the Tire and Loading Information placard on the driver's door B-pillar or, if available, on the tire inflation pressure label located on the inside of the fuel filler flap.

The Run Flat Indicator does not replace regular checks of the tire inflation pressures since a gradual pressure loss in more than one tire cannot be detected by the Run Flat Indicator.

The Run Flat Indicator is not able to issue a warning due to a sudden dramatic loss of tire inflation pressure (e.g. tire blowout caused by a foreign object). In this case bring the vehicle to a halt by carefully applying the brakes and avoiding abrupt steering maneuvers.

### Restarting the Run Flat Indicator



The Run Flat Indicator must be restarted in the following situations:

- after you have changed the tire inflation pressure
- after you have replaced the wheels or tires
- after you have installed new wheels or tires
- ▶ Using the Tire and Loading Information placard on the driver's door B-pillar or, if available, the tire inflation pressure label on the inside of the fuel filler flap, make sure the tire inflation pressure of all four tires is correct.

#### **Warning!**

The Run Flat Indicator can only warn you in a reliable manner if you have set the correct tire inflation pressures for each tire.

If an incorrect tire inflation pressure was set, the system will monitor the pressure according to the incorrect value.

- ▶ Switch on the ignition.
- ▶ Make sure the standard display appears in the multifunction display (▷ page 143).
- ▶ Press button  or  on the multifunction steering wheel repeatedly

until the following message appears in the multifunction display:

Run Flat Indicator  
Active  
Menu: R-Button

- ▶ Press the reset button (▷ page 138). The following message will appear in the multifunction display:  
Restart  
Run Flat Indicator?

- ▶ **If you wish to confirm:** Press button . The following message will appear in the multifunction display:  
Run Flat Indicator  
Restarted

After a certain “learning phase”, the Run Flat Indicator checks the set pressure values for all four tires.





- ▶ **If you wish to cancel:** Press button .

### Tire Pressure Monitoring Systems

Your vehicle may be equipped with the Tire Pressure Monitoring System (TPMS, USA only) or the Advanced Tire Pressure Monitoring System (Advanced TPMS, Canada only). Both systems measure the tire inflation

pressure in the vehicle's tires and issue warnings in case of pressure loss.

To determine which system your vehicle is equipped with, do the following:

- ▶ Switch on the ignition.
- ▶ Press button  or  on the multifunction steering wheel repeatedly until the standard display appears in the multifunction display (▷ page 143).
- ▶ Press button  or  repeatedly. In vehicles with TPMS, the following message appears in the multifunction display:  
Tire Pressure Monitor  
Active  
Menu: R-Button

In vehicles with Advanced TPMS, the current tire inflation pressure for each tire appears in the multifunction display after a few minutes of driving.



Display in vehicles with Advanced TPMS

## Tires and wheels

The TPMS is equipped with a combination low tire pressure/ TPMS malfunction telltale (USA) or a low tire pressure telltale (Canada) in the instrument cluster. Depending on how the telltale illuminates, it indicates a low tire pressure condition or a malfunction in the TPMS system itself:

- If the telltale illuminates continuously, one or more of your tires is significantly underinflated. There is no malfunction in the TPMS.
- USA only: If the telltale flashes for 60 seconds and then stays illuminated, the TPMS system itself is not operating properly.

The TPMS only functions on wheels that are equipped with the proper electronic sensors. It monitors the tire inflation pressure, as selected by the driver, in all four tires. A warning is issued to alert you to a decrease in pressure in one or more of the tires.

### **Warning!**

The TPMS does not indicate a warning for wrongly selected inflation pressures. Always adjust tire inflation pressure according to the Tire and Loading Information placard or, if available, on the supplemental tire inflation pressure

information on the inside of the fuel filler flap.

The TPMS is not able to issue a warning due to a sudden dramatic loss of pressure (e.g. tire blowout caused by a foreign object). In this case bring the vehicle to a halt by carefully applying the brakes and avoiding abrupt steering maneuvers.

### **Warning!**

Each tire, including the spare (if provided), should be checked every other week when cold and inflated to the inflation pressure recommended by the vehicle manufacturer on the Tire and Loading Information placard on the driver's door B-pillar or, if available, the tire inflation pressure label on the inside of the fuel filler flap. If your vehicle has tires of a different size than the size indicated on the vehicle placard or the tire inflation pressure label, you should determine the proper tire inflation pressure for those tires.

As an added safety feature, your vehicle has been equipped with a tire pressure monitoring system (TPMS) that illuminates a low tire pressure telltale when one or more of your tires are significantly underinflated. Accordingly, when the low tire pressure telltale illuminates, you should

stop and check your tires as soon as possible, and inflate them to the proper pressure. Driving on a significantly underinflated tire causes the tire to overheat and can lead to tire failure. Underinflation also reduces fuel efficiency and tire tread life, and may affect the vehicle's handling and stopping ability. Please note that the TPMS is not a substitute for proper tire maintenance, and it is the driver's responsibility to maintain correct tire pressure, even if underinflation has not reached the level to trigger illumination of the TPMS low tire pressure telltale.

USA only:

Your vehicle has also been equipped with a TPMS malfunction indicator to indicate when the system is not operating properly. The TPMS malfunction indicator is combined with the low tire pressure telltale. When the system detects a malfunction, the telltale will flash for approximately 1 minute and then remain continuously illuminated. This sequence will continue upon subsequent vehicle start-ups as long as the malfunction exists. When the malfunction indicator is illuminated, the system may not be able to

## Tires and wheels

detect or signal low tire pressure as intended.

TPMS malfunctions may occur for a variety of reasons, including the installation of replacement or alternate tires or wheels on the vehicle that prevent the TPMS from functioning properly. Always check the TPMS malfunction telltale after replacing one or more tires or wheels on your vehicle to ensure that the replacement or alternate tires and wheels allow the TPMS to continue to function properly.

**i** USA only:

If a condition causing the TPMS to malfunction develops, it may take up to 10 minutes for the system to signal a malfunction using the TPMS telltale flashing and illumination sequence.

The telltale extinguishes after a few minutes driving if the malfunction has been corrected.

**i** Operating radio transmission equipment (e.g. wireless headsets, two-way radios) in or near the vehicle could cause the TPMS to malfunction.

**1** USA only:

This device complies with Part 15 of the FCC Rules. Operation is subject to the following two conditions:

1. This device may not cause harmful interference, and
2. this device must accept any interference received, including interference that may cause undesired.

Any unauthorized modification to this device could void the user's authority to operate the equipment.

**i** Canada only:

This device complies with RSS-210 of Industry Canada. Operation is subject to the following two conditions:





1. This device may not cause interference, and
2. this device must accept any interference received, including interference that may cause undesired operation of the device.

Any unauthorized modification to this device could void the user's authority to operate the equipment.

**Advanced TPMS features**

Tire pressure inquiries are made using the multifunction display. The current tire inflation pressure for each tire appears in the multifunction display after a few minutes of driving.

**i** Possible differences between the readings of a tire pressure gauge of an air hose, e.g. gas station equipment, and the vehicle's control system can occur. The tire pressure displayed by the control system apply to sea level. In high-altitude locations, the reading on a tire pressure gauge will be higher than the reading issued by the vehicle's control system. Do not reduce the tire inflation pressure under such circumstances.

- ▶ Switch on the ignition.
- ▶ Press button  or  on the multifunction steering wheel repeatedly until the standard display appears in the multifunction display (▷ page 143).
- ▶ Press button  or  until the current inflation pressures for each tire appear in the multifunction display.

## Tires and wheels



When the vehicle has been parked for longer than 20 minutes, the message Tire pressure displayed after driving for a few minutes. appears in the multifunction display.

**i** With a spare wheel mounted, the system may still indicate the tire inflation pressure of the removed road wheel for some minutes. If this happens, keep in mind that the indicated value where the spare wheel is mounted does not reflect the actual spare tire inflation pressure.

### Tire inflation pressure warnings

If the system detects a significant loss of tire inflation pressure in one or more than one tire, a message appears in the multifunction display. In addition, an acoustic warning sounds and the low tire pressure telltale in the instrument cluster comes on.



Vehicles with TPMS



Vehicles with Advanced TPMS

Vehicles with Advanced TPMS: The respective tire is indicated by a red rectangle.

### Restarting TPMS

#### **⚠ Warning!**

It is the driver's responsibility to set the tire inflation pressure to the recommended cold tire inflation pressure. Underinflated tires affect the ability to steer or brake the vehicle. You might lose control over the vehicle.

When you restart the TPMS, the system sets new reference values for each tire.





The TPMS must be restarted when you have adjusted the tire inflation pressure to a new level (e.g. because of different load or driving conditions). The TPMS is then recalibrated to the current tire inflation pressures.

**i** Vehicles with Advanced TPMS only:  
The TPMS usually recognizes tire pressure adjustments and sets new reference values automatically. You can, however, restart the TPMS manually as described.

Restart the TPMS after adjusting the tire inflation pressure to the inflation pressure recommended for the vehicle operating condition. Tire pressure should only be adjusted on cold tires. Observe the recommended tire inflation pressure on the Tire and Loading Information placard on the driver's door B-pillar. Some vehicles may have supplemental tire pressure information for driving at high speeds or for vehicle loads less than the maximum loaded vehicle condition. If such information is provided, it can be found on the inside of the fuel filler flap.

► Using the Tire and Loading Information placard on the driver's door B-pillar (> page 250) or, if available, the

supplemental tire inflation pressure information on the inside of the fuel filler flap, make sure the tire inflation pressure of all four tires is correct.

- ▶ Switch on the ignition.
- ▶ Press button  or  on the multifunction steering wheel repeatedly until the standard display appears in the multifunction display (▷ page 143).
- ▶ Press button  or  repeatedly until the current inflation pressure for each tire (Advanced TPMS) or the following message (TPMS) appears in the display :  
Tire Pressure Monitor  
Active  
Menu: R-Button

- ❶ Vehicles with Advanced TPMS: The Tire pressure displayed after driving for a few minutes. may appear before the tire inflation pressures are displayed.
- ▶ Press the reset button (▷ page 138). The following message will appear in the multifunction display:  
Restart tire  
pressure monitor?

- ▶ **If you wish to confirm:** Press button .

The following message will appear in the multifunction display:  
Tire Pressure Monitor  
Restarted

After driving a few minutes the system verifies that the current tire inflation pressures are within the system's specified range. Afterwards the current tire inflation pressures are accepted as reference values and then monitored.

- ▶ **If you wish to cancel:** Press button .

- ❶ Vehicles with Advanced TPMS: When the wheel positions have been changed, the air pressure of a tire may be displayed for the wrong position temporarily. After driving for a few minutes, the air pressure will be shown for the correct position.

### Tire labeling

Besides tire name (sales designation) and manufacturer name, a number of markings can be found on a tire.

Following are some explanations for the markings on your vehicle's tires:



- ❶ Uniform Tire Quality Grading Standards (▷ page 267)
- ❷ DOT, Tire Identification Number (▷ page 265)
- ❸ Maximum tire load (▷ page 266)
- ❹ Maximum tire inflation pressure (▷ page 266)



## Tires and wheels

- ⑤ Manufacturer
  - ⑥ Tire ply material (▷ page 268)
  - ⑦ Tire size designation, load and speed rating (▷ page 262)
  - ⑧ Load identification (▷ page 264)
  - ⑨ Tire name
- i** For illustration purposes only. Actual data on tires are specific to each vehicle and may vary from data shown in above illustration.
- For more information, see “Rims and tires” (▷ page 384).

### Tire size designation, load and speed rating

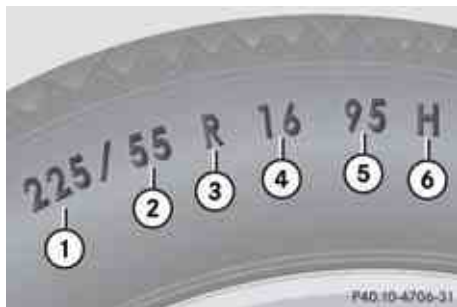

- ① Tire width
- ② Aspect ratio in %

- ③ Radial tire code
- ④ Rim diameter
- ⑤ Tire load rating
- ⑥ Tire speed rating

**i** For illustration purposes only. Actual data on tires are specific to each vehicle and may vary from data shown in above illustration.

General: Depending on the design standards used, the tire size molded into the sidewall may have no letter or a letter preceding the tire size designation.

No letter preceding the size designation (as illustrated above): Passenger car tire based on European design standards.

Letter “P” preceding the size designation: Passenger car tire based on U.S. design standards.

Letter “LT” preceding the size designation: Light Truck tire based on U.S. design standards.

Letter “T” preceding the size designation: Temporary spare tires which are high pressure compact spares designed for temporary emergency use only.

### Tire width

Tire width ① indicates the nominal tire width in millimeters.

### Aspect ratio

Aspect ratio ② is the dimensional relationship between tire section height and section width and is expressed in percentage. The aspect ratio is arrived at by dividing section height by section width.

### Tire code

Tire code ③ indicates the tire construction type. The “R” stands for radial tire type. Letter “D” means diagonal or bias ply construction; letter “B” means belted-bias ply construction.

At the tire manufacturer’s option, any tire with a speed capability above 149 mph (240 km/h) can include a “ZR” in the size designation (for example: 245/40 ZR 18). For additional information, see “Tire speed rating” (▷ page 263).

### Rim diameter

Rim diameter ④ is the diameter of the bead seat, not the diameter of the rim edge. The rim diameter is indicated in inches (in).



Tires and wheels

**Tire load rating**

**⚠ Warning!**

The tire load rating must always be at least half of the GAWR of your vehicle.

Otherwise, tire failure may be the result which may cause an accident and/or serious injury to you or others.

Always replace rims and tires with the same designation, manufacturer and type as shown on the original part.

**⚠ Warning!**

Do not overload the tires by exceeding the specified load limit as indicated on the Tire and Loading Information placard on the driver's door B-pillar. Overloading the tires can overheat them, possibly causing a blowout. Overloading the tires can also result in handling or steering problems, or brake failure.

Tire load rating ⑤ is a numerical code associated with the maximum load a tire can support.

For example, a load rating of 91 corresponds to a maximum load of 1356 lb (615 kg) the tire is designed to support. See also "Maximum tire load" (▷ page 266) where the

maximum load associated with the load index is indicated in kilograms and lbs.

For additional information on tire load rating, see "Load identification" (▷ page 264).

**Tire speed rating**

**⚠ Warning!**

Even when permitted by law, never operate a vehicle at speeds greater than the maximum speed rating of the tires.

Exceeding the maximum speed for which tires are rated can lead to sudden tire failure, causing loss of vehicle control and possibly resulting in an accident and/or serious personal injury and possible death, for you and for others.

Regardless of the tire speed rating, local speed limits should be obeyed. Use prudent driving speeds appropriate to prevailing conditions.

Tire speed rating ⑥ indicates the approved maximum speed for the tire.

Summer tires

Index	Speed rating
Q	up to 100 mph (160 km/h)
R	up to 106 mph (170 km/h)

Index	Speed rating
S	up to 112 mph (180 km/h)
T	up to 118 mph (190 km/h)
H	up to 130 mph (210 km/h)
V	up to 149 mph (240 km/h)
W	up to 168 mph (270 km/h)
Y	up to 186 mph (300 km/h)
ZR...Y	up to 186 mph (300 km/h)
ZR...(..Y)	above 186 mph (300 km/h)
ZR	above 149 mph (240 km/h)

- At the tire manufacturer's option, any tire with a speed capability above 149 mph (240 km/h) can include a "ZR" in the size designation (for example: 245/40 ZR18). To determine the maximum speed capability of the tire, the service description for the tire must be referred to. The service description is comprised of tire load rating ⑤ and tire speed rating ⑥. If your tire includes "ZR" in the size designation and no service description is given, the tire manufacturer must be

## Tires and wheels

consulted for the maximum speed capability.

If a service description is given, the speed capability is limited by the speed symbol in the service description. Example: 245/40 ZR18 97Y. In this example, “97Y” is the service description. The letter “Y” designates the speed rating and the speed capability of the tire is limited to 186 mph (300 km/h).

- Any tire with a speed capability above 186 mph (300 km/h) must include a “ZR” in the size designation AND the service description must be placed in parenthesis. Example: 275/40 ZR 18 (99Y). The “(Y)” speed rating in parenthesis designates the maximum speed capability of the tire as being above 186 mph (300 km/h). Consult the tire manufacturer for the actual maximum permissible speed of the tire.

All-season and winter tires

Index	Speed rating
Q M+S <sup>15</sup>	up to 100 mph (160 km/h)
T M+S <sup>15</sup>	up to 118 mph (190 km/h)

<sup>15</sup> or M+S  for winter tires

Index	Speed rating
H M+S <sup>15</sup>	up to 130 mph (210 km/h)
V M+S <sup>15</sup>	up to 149 mph (240 km/h)

- i** Not all M+S rated tires provide special winter performance. Make sure the tires you use show M+S and the mountain/snowflake  marking on the tire sidewall. These tires meet specific snow traction performance requirements of the Rubber Manufacturers Association (RMA) and the Rubber Association of Canada (RAC) and have been designed specifically for use in snow conditions.

An electronic speed limiter prevents your vehicle from exceeding a speed of:

- All models except E 63 AMG: 130 mph (210 km/h)
- E 63 AMG: 155 mph (250 km/h)
- E 63 AMG with increased top speed E 63 AMG (Performance Package): 186 mph (300 km/h)

The factory equipped tires on your vehicle may have a tire speed rating above the

maximum speed permitted by the electronic speed limiter.

Make sure your tires have the required tire speed rating as specified for your vehicle in the “Technical data” section (▷ page 384), for example when purchasing new tires.

If you are uncertain about the correct reading of the information given on a tire’s sidewall, any authorized Mercedes-Benz Center will be glad to assist you.

### Load identification



**1** Load identification

- i** For illustration purposes only. Actual data on tires are specific to each vehicle and

## Tires and wheels

may vary from data shown in above illustration.

In addition to tire load rating, special load identification ① may be molded into the tire sidewall following the letter designating the tire speed rating ⑥ (> page 262).

- No specification given: absence of any text (like in above example) indicates a standard load (SL) tire.
- XL or Extra Load: designates an extra load (or reinforced) tire.
- Light Load: designates a light load tire.
- C, D, E: designates load range associated with the maximum load a tire can carry at a specified pressure.

**DOT, Tire Identification Number (TIN)**

U.S. tire regulations require each new tire manufacturer or tire retreader to mold a TIN into or onto a sidewall of each tire produced. The TIN is a unique identifier which facilitates efforts by tire manufacturers to notify purchasers in recall situations or other safety matters concerning tires and gives purchasers the means to easily identify such tires.

The TIN is comprised of “Manufacturer’s identification mark”, “Tire size”, “Tire type code” and “Date of manufacture”.



- ① DOT
- ② Manufacturer’s identification mark
- ③ Tire size

- ④ Tire type code (at the option of the tire manufacturer)
- ⑤ Date of manufacture

**i** For illustration purposes only. Actual data on tires are specific to each vehicle and may vary from data shown in above illustration.

**DOT (Department of Transportation)**

Tire branding symbol ① denotes that the tire meets requirements of the U.S. Department of Transportation.

**Manufacturer’s identification mark**

Manufacturer’s identification mark ② denotes the tire manufacturer.

New tires have a mark with two symbols.

Retreaded tires have a mark with four symbols. For more information on retreaded tires, see (> page 247).

**Tire size**

Code ③ indicates the tire size.

## Tires and wheels

### Tire type code

Tire type code ④ may, at the option of the manufacturer, be used as a descriptive code for identifying significant characteristics of the tire.

### Date of manufacture

The date of manufacture ⑤ identifies the week and year of manufacture.

The first two figures identify the week, starting with “01” to represent the first full week of the calendar year. The second two figures represent the year.

For example, “3202” represents the 32nd week of 2002.

### Maximum tire load

#### **Warning!**

Do not overload the tires by exceeding the specified load limit as indicated on the Tire and Loading Information placard on the driver’s door B-pillar. Overloading the tires can overheat them, possibly causing a blowout. Overloading the tires can also result in handling or steering problems, or brake failure.



① Maximum tire load rating

**i** For illustration purposes only. Actual data on tires are specific to each vehicle and may vary from data shown in above illustration.

The maximum tire load is the maximum weight the tires are designed to support.

For more information on tire load rating, see (> page 263).

For information on calculating total and cargo load capacities, see (> page 251).

### Maximum tire inflation pressure

#### **Warning!**

Never exceed the maximum tire inflation pressure. Follow recommended tire inflation pressures.

Do not underinflate tires. Underinflated tires wear excessively and/or unevenly, adversely affect handling and fuel economy, and are more likely to fail from being overheated.

Do not overinflate tires. Overinflated tires can adversely affect handling and ride comfort, wear unevenly, increase stopping distance, and result in sudden deflation (blowout) because they are more likely to become punctured or damaged by road debris, potholes etc.

Tires and wheels

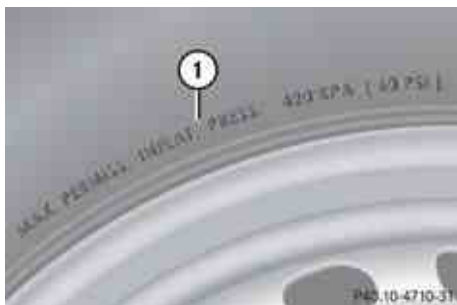

① Maximum permissible tire inflation pressure

**i** For illustration purposes only. Actual data on tires are specific to each vehicle and may vary from data shown in above illustration.

This is the maximum permissible tire inflation pressure for the tire.

Always follow the recommended tire inflation pressure (▷ page 253) for proper tire inflation.

**Uniform Tire Quality Grading Standards**

The Uniform Tire Quality Grading is a U.S. Government requirement designed to give drivers consistent and reliable information regarding tire performance. Tire manufacturers are required to grade tires based on three performance factors: treadwear, traction, and temperature resistance. Although not a Government of Canada requirement, all tires made for sale in North America have these grades branded on the sidewall.



- ① Treadwear
- ② Traction
- ③ Temperature resistance

**i** For illustration purposes only. Actual data on tires are specific to each vehicle and may vary from data shown in above illustration.

Quality grades can be found, where applicable, on the tire sidewall between tread shoulder and maximum section width. For example:

Treadwear	Traction	Temperature
200	AA	A

All passenger car tires must conform to federal safety requirements in addition to these grades.

**Treadwear**

The treadwear grade is a comparative rating based on the wear rate of the tire when tested under controlled conditions on a specified U.S. Government test course. For example, a tire graded 150 would wear one and one-half (1 1/2) times as well on the government course as a tire graded 100.

The relative performance of tires depends upon the actual conditions of their use, however, and may depart significantly from the norm due to variations in driving habits,



## Tires and wheels

service practices and differences in road characteristics and climate.

### Traction

#### **Warning!**

The traction grade assigned to this tire is based on straight-ahead braking traction tests, and does not include acceleration, cornering, hydroplaning, or peak traction characteristics.

The traction grades, from highest to lowest, are AA, A, B, and C. Those grades represent the tire's ability to stop on wet pavement as measured under controlled conditions on specified government test surfaces of asphalt and concrete. A tire marked C may have poor traction performance.

#### **Warning!**

If ice has formed on the road, tire traction will be substantially reduced. Under such weather conditions, drive, steer and brake with extreme caution.

The safe speed on a wet, snow covered or icy road is always lower than on a dry road.

You should pay particular attention to the condition of the road whenever the outside temperature is close to the freezing point.

Mercedes-Benz recommends winter tires (> page 272) with a minimum tread depth of approximately  $\frac{1}{6}$  in (4 mm) on all four wheels for the winter season to ensure normal balanced handling characteristics. On packed snow, they can reduce your stopping distance compared to summer tires. Stopping distance, however, is still considerably greater than when the road is not covered with snow or ice. Exercise appropriate caution.

 **!** Avoid spinning of a drive wheel. This may cause serious damage to the drivetrain which is not covered by the Mercedes-Benz Limited Warranty.

### Temperature

#### **Warning!**

The temperature grade for this tire is established for a tire that is properly inflated and not overloaded. Excessive speed, underinflation, or excessive loading, either separately or in combination, can cause excessive heat build-up and possible tire failure.

The temperature grades are A (the highest), B, and C, representing the tire's resistance to the generation of heat and its ability to

dissipate heat when tested under controlled conditions on a specified indoor laboratory test wheel. Sustained high temperature can cause the material of the tire to degenerate and reduce tire life, and excessive temperature can lead to sudden tire failure. The grade C corresponds to a level of performance which all passenger car tires must meet under the Federal Motor Vehicle Safety Standard No. 109. Grades B and A represent higher levels of performance on the laboratory test wheel than the minimum required by law.

### Tire ply material



- ① Plies in sidewall
- ② Plies under tread

## Tires and wheels

**i** For illustration purposes only. Actual data on tires are specific to each vehicle and may vary from data shown in above illustration.

This marking tells you about the type of cord and number of plies in the sidewall and under the tread.

### Tire and loading terminology

#### Accessory weight

The combined weight (in excess of those standard items which may be replaced) of automatic transmission, power steering, power brakes, power windows, power seats, radio, and heater, to the extent that these items are available as factory-installed equipment (whether installed or not).

#### Air pressure

The amount of air inside the tire pressing outward on each square inch of the tire. Air pressure is expressed in pounds per square inch (psi), or kilopascal (kPa) or bar.

#### Aspect ratio

Dimensional relationship between tire section height and section width expressed in percentage.

#### Bar

Another metric unit for air pressure. There are 14.5038 pounds per square inch (psi) to 1 bar; there are 100 kilopascals (kPa) to 1 bar.

#### Bead

The tire bead contains steel wires wrapped by steel cords that hold the tire onto the rim.

#### Cold tire inflation pressure

Tire inflation pressure when your vehicle has been sitting for at least 3 hours or driven no more than 1 mile (1.6 km).

#### Curb weight

The weight of a motor vehicle with standard equipment including the maximum capacity of fuel, oil, and coolant, and, if so equipped, air conditioning and additional optional equipment, but without passengers and cargo.

#### DOT (Department of Transportation)

A tire branding symbol which denotes the tire meets requirements of the U.S. Department of Transportation.

#### GAWR (Gross Axle Weight Rating)

The GAWR is the maximum permissible axle weight. The gross vehicle weight on each axle must never exceed the GAWR for the front and rear axle indicated on the certification label located on the driver's door B-pillar.

#### GVW (Gross Vehicle Weight)

The GVW comprises the weight of the vehicle including fuel, tools, spare wheel, installed accessories, passengers and cargo and, if applicable, trailer tongue load. The GVW must never exceed the GVWR indicated on the certification label located on the driver's door B-pillar.

#### GVWR (Gross Vehicle Weight Rating)

This is the maximum permissible vehicle weight of the fully loaded vehicle (weight of the vehicle including all options, passengers, fuel, and cargo and, if applicable, trailer



### Tires and wheels

tongue load). It is indicated on certification label located on the driver's door B-pillar.

#### Kilopascal (kPa)

---

The metric unit for air pressure. There are 6.9 kPa to 1 psi; another metric unit for air pressure is bar. There are 100 kilopascals (kPa) to 1 bar.

#### Maximum load rating

---

The maximum load in kilograms and pounds that can be carried by the tire.

#### Maximum loaded vehicle weight

---

The sum of curb weight, accessory weight, total load limit, and production options weight.

#### Maximum permissible tire inflation pressure

---

This number is the greatest amount of air pressure that should ever be put in the tire.

#### Normal occupant weight

---

The number of occupants the vehicle is designed to seat, multiplied by 68 kilograms (150 lb).

#### Occupant distribution

---

The distribution of occupants in a vehicle at their designated seating positions.

#### Production options weight

---

The combined weight of those installed regular production options weighing over 5 lbs (2.3 kilograms) in excess of those standard items which they replace, not previously considered in curb weight or accessory weight, including heavy duty brakes, ride levelers, roof rack, heavy duty battery, and special trim.

#### PSI (Pounds per square inch)

---

A standard unit of measure for air pressure.

#### Recommended tire inflation pressure

---

The recommended tire inflation pressure for normal driving conditions is listed on the Tire and Loading Information placard located on the driver's door B-pillar and provides best

handling, tread life and riding comfort. If so equipped, supplemental information pertaining to special driving situations can be found on the tire inflation pressure label on the inside of the fuel filler flap.

#### Rim

---

A metal support for a tire or a tire and tube assembly upon which the tire beads are seated.

#### Sidewall

---

The portion of a tire between the tread and the bead.

#### TIN (Tire Identification Number)

---

Unique identifier which facilitates efforts by tire manufacturers to notify purchasers in recall situations or other safety matters concerning tires and gives purchasers the means to easily identify such tires. The TIN is comprised of "Manufacturer's identification mark", "Tire size", "Tire type code" and "Date of manufacture".



## Tires and wheels

**Tire load rating**

Numerical code associated with the maximum load a tire can support.

**Tire ply composition and material used**

This indicates the number of plies or the number of layers of rubber-coated fabric in the tire tread and sidewall. Tire manufacturers also must indicate the ply materials in the tire and sidewall, which include steel, nylon, polyester, and others.

**Tire speed rating**

Part of tire designation; indicates the speed range for which a tire is approved.

**Total load limit**

Rated cargo and luggage load plus 68 kilograms (150 lb) times the vehicle's designated seating capacity.

**Traction**

Force exerted by the vehicle on the road via the tires. The amount of grip provided.

**Tread**

The portion of a tire that comes into contact with the road.

**Treadwear indicators**

Narrow bands, sometimes called "wear bars" that show across the tread of a tire when only  $\frac{1}{16}$  in (1.6 mm) of tread remains.

**Uniform Tire Quality Grading Standards**

A tire information system that provides consumers with ratings for a tire's traction, temperature and treadwear. Ratings are determined by tire manufacturers using U.S. government testing procedures. The ratings are molded into the sidewall of the tire.

**Vehicle maximum load on the tire**

Load on an individual tire that is determined by distributing to each axle its share of the maximum loaded vehicle weight and dividing it by two.

**Rotating tires****⚠ Warning!**

Rotate front and rear wheels only if the tires are of the same dimension.

If your vehicle is equipped with mixed-size tires (different tire dimensions front vs. rear), tire rotation is not possible.

**⚠ Warning!**

Have the tightening torque checked after changing a wheel. Wheels could become loose if not tightened with a torque of 96 lb-ft (130 Nm).

Only use genuine Mercedes-Benz wheel bolts specified for your vehicle's rims.

Tire rotation can be performed on vehicles with tires of the same dimension all around. If your vehicle is equipped with tires of the same dimension all around, tires can be rotated, observing a front-to-rear rotation pattern that will maintain the intended rotation (spinning) direction of the tire (▷ page 249).

In some cases, such as when your vehicle is equipped with mixed-size tires (different tire dimension front vs. rear), tire rotation is not possible.



## Winter driving

If applicable to your vehicle's tire configuration, tires can be rotated according to the tire manufacturer's recommended intervals in the tire manufacturer's warranty pamphlet located in your vehicle literature portfolio. If none is available, tires should be rotated every 3 000 to 6 000 miles (5 000 to 10 000 km), or sooner if necessary, according to the degree of tire wear. The same rotation (spinning) direction must be maintained.

Rotate tires before the characteristic tire wear pattern becomes visible (shoulder wear on front tires and tread center wear on rear tires).

Thoroughly clean the mounting face of wheels and brake disks, i.e. the inner side of the wheels/tires, during each rotation. Check for and ensure proper tire inflation pressure.

For information on wheel change, see "Flat tire" (> page 355).

### Winter driving

#### General information

Have your vehicle winterized at an authorized Mercedes-Benz Center.

#### Winter tires

##### **Warning!**

Winter tires with a tread depth of less than  $\frac{1}{6}$  in (4 mm) must be replaced. They are no longer suitable for winter operation.

##### **Warning!**

If you use your spare wheel when winter tires are fitted on the other wheels, be aware that the difference in tire characteristics may very well impair turning stability and that overall driving stability may be reduced. Adapt your driving style accordingly.

Have the spare wheel replaced by regular road wheel with a winter tire at the nearest authorized Mercedes-Benz Center.

Always use winter tires at temperatures below 45°F (7°C) and whenever wintry road conditions prevail. Not all M+S rated tires provide special winter performance. Make

sure the tires you use show the mountain/snowflake  marking on the tire sidewall. These tires meet specific snow traction performance requirements of the Rubber Manufacturers Association (RMA) and the Rubber Association of Canada (RAC) and have been designed specifically for use in snow conditions. Use of winter tires is the only way to achieve the maximum effectiveness of your vehicle's driving safety systems such as the ABS and the ESP® in winter operation.

For safe handling, make sure all mounted winter tires are of the same make and have the same tread design.

For information on winter tires for your vehicle model, see the "Technical data" section (> page 384).

Always observe the speed rating of the winter tires installed on your vehicle. If the maximum speed for which your tires are rated is below the speed rating of your vehicle, you must place a notice to this effect where it will be seen by the driver. Such notices are available at your tire dealer or any authorized Mercedes-Benz Center.

## Winter driving

## Snow chains

**!** When driving with snow chains, always select the raised level of the vehicle level control. Other settings may result in damage to your vehicle.

**!** Some tire sizes do not leave adequate clearance for snow chains. To help avoid serious damage to your vehicle or tires, make sure the use of snow chains is permissible as specified in the “Technical data” section of this Operator’s Manual.

Snow chains should only be driven on snow-covered roads at speeds not to exceed 30 mph (50 km/h). Remove chains as soon as possible when driving on roads without snow.

Observe the following guidelines when using snow chains:

- Use of snow chains is not permissible with all wheel/tire combinations (▷ page 384).
- Use snow chains in pairs and on rear wheels only. Follow the manufacturer’s mounting instructions.

**!** If snow chains are mounted to the front wheels, they may scrape against the body

or axle components. The tires or the vehicle could be damaged as a result.

- Only use snow chains that are approved by Mercedes-Benz. Any authorized Mercedes-Benz Center will be glad to advise you on this subject.
- Use of snow chains may be prohibited depending on location. Always check local and state laws before installing snow chains.
- Do not use snow chains on the spare wheel.

**i** When driving with snow chains, you may wish to switch off the ESP® (▷ page 72) before setting the vehicle in motion. This will improve the vehicle’s traction.

## Winter driving instructions

**⚠ Warning!**

If the vehicle becomes stuck in snow, make sure snow is kept clear of the exhaust pipe and from around the vehicle with the engine running. Otherwise, deadly carbon monoxide (CO) gases may enter vehicle interior resulting in unconsciousness and death.

To assure sufficient fresh air ventilation, open a window slightly on the side of the vehicle not facing the wind.

**⚠ Warning!**

The outside temperature indicator is not designed to serve as an ice-warning device and is therefore unsuitable for that purpose.

Indicated temperatures just above the freezing point do not guarantee that the road surface is free of ice. The road may still be icy, especially in wooded areas or on bridges.

**⚠ Warning!**

On slippery road surfaces, never downshift in order to obtain braking action. This could result in drive wheel slip and reduced



## Driving instructions

vehicle control. Your vehicle's ABS will not prevent this type of loss of control.

The most important rule for slippery or icy roads is to drive sensibly and to avoid abrupt acceleration, braking and steering maneuvers. Do not use the cruise control system under such conditions.

When the vehicle is in danger of skidding, shift the automatic transmission to neutral position **N**. Try to keep the vehicle under control by corrective steering action.

**i** For information on driving with snow chains, see "Snow chains" (▷ page 273).

Road salts and chemicals can adversely affect braking efficiency. Increased pedal force may become necessary to produce the normal brake effect.

Depressing the brake pedal periodically when traveling at length on salt-strewn roads can bring road-salt-impaired braking efficiency back to normal.

If the vehicle is parked after being driven on salt-treated roads, the braking efficiency should be tested as soon as possible after driving is resumed.

### **Warning!**

Make sure not to endanger any other road users when carrying out these braking maneuvers.

## Driving instructions

### Drive sensibly – save fuel

To save fuel you should:

- Keep tires at the recommended inflation pressures.
- Remove unnecessary loads.
- Remove roof rack when not in use.
- Allow engine to warm up under low load use.
- Avoid frequent acceleration and deceleration.
- Have all maintenance work performed at the intervals specified in the Maintenance Booklet and as required by the Maintenance system. Contact an authorized Mercedes-Benz Center.

Fuel consumption is also increased by driving in cold weather, in stop-and-go traffic, on short trips and in mountainous areas.

## Driving instructions

### Drinking and driving

#### Warning!

Drinking and driving and/or taking drugs and driving are very dangerous combinations. Even a small amount of alcohol or drugs can affect your reflexes, perceptions and judgment.

The possibility of a serious or even fatal accident are greatly increased when you drink or take drugs and drive.

Do not drink or take drugs and drive or allow anyone to drive who has been drinking or taking drugs.

### Pedals

#### Warning!

Make sure absolutely no objects are obstructing the pedals' range of movement. Keep the driver's footwell clear of all obstacles. If there are any floor mats or carpets in the footwell, make sure that the pedals still have sufficient clearance.

During sudden driving or braking maneuvers, the objects could get caught between the pedals. You could then no

longer brake or accelerate. This could lead to accidents and injury.

### Power assistance

#### Warning!

There is no power assistance for the steering and the service brake when the engine is not running.

Steering and braking requires significantly more effort and you could lose control of the vehicle and cause an accident as a result.

Do not turn off the engine while the vehicle is in motion.

### Brakes

#### Downhill grades

 When driving down long and steep grades, relieve the load on the brakes by shifting into a lower gear to use the engine's braking power. This helps prevent overheating of the brakes and reduces wear.

When using the engine's braking power, a drive wheel may not spin for an extended period of time, e.g. on slippery road

surfaces. This may cause serious damage to the drivetrain which is not covered by the Mercedes-Benz Limited Warranty.

### Continuous or hard braking

#### Warning!

Resting your foot on the brake pedal will cause excessive and premature wear of the brake pads.

It can also result in the brakes overheating, thereby significantly reducing their effectiveness. It may not be possible to stop the vehicle in sufficient time to avoid an accident.

After hard braking, it is advisable to drive on for some time, rather than immediately park, so that the air stream will cool down the brakes faster.

### Wet roads

#### Warning!

After driving in heavy rain for some time without applying the brakes or through water deep enough to wet brake components, the first braking action may be somewhat reduced and increased pedal pressure may be necessary to obtain



## Driving instructions

expected brake effect. Maintain a safe distance from vehicles in front.

To help prevent brake disk corrosion after driving on wet or salt-covered roads, it is advisable to brake the vehicle with considerable force prior to parking. The heat generated serves to dry the brakes.

### Salt-covered roads

#### **Warning!**

A layer of salt on the brake discs and the brake linings may cause a delay in the braking effect, resulting in a significantly increased braking distance, which could lead to an accident.

To avoid this danger, you should:

- occasionally brake carefully when you are driving on salt-covered roads, so that any layer of salt that may have built up on the brake discs and the brake linings is removed without putting other road users at risk
- maintain a greater distance to the vehicle ahead and drive with particular care
- carefully apply the brakes at the end of a trip and immediately after commencing a

new trip, so that salt residues are removed from the brake disc

### Brake service

 The brake fluid level in the reservoir may be too low if the brake warning lamp in the instrument cluster comes on and an acoustic warning sounds although the parking brake is released. Observe additional messages in the multifunction display that may appear.

Brake pad wear or a leak in the system may be the reason for low brake fluid in the reservoir.

Have the brake system inspected immediately. Contact an authorized Mercedes-Benz Center.

All checks and service work on the brake system should be carried out by qualified technicians only. Contact an authorized Mercedes-Benz Center.

Only install brake pads and use brake fluid recommended by Mercedes-Benz.

#### **Warning!**

If other than recommended brake pads are installed, or other than recommended brake fluid is used, the braking properties

of the vehicle can be degraded to an extent that safe braking is substantially impaired. This could result in an accident.

#### Vehicles with 4MATIC:

Only conduct operational or performance tests on a two-axle dynamometer. If such tests are necessary, contact an authorized Mercedes-Benz Center. You could otherwise seriously damage the brake system or the transfer case which is not covered by the Mercedes-Benz Limited Warranty.

#### Vehicles with 4MATIC:

Because the ESP<sup>®</sup> operates automatically, the engine and ignition must be shut off (SmartKey in starter switch position **0** or **1** or KEYLESS-GO start/stop button in position **0** or **1**) when the parking brake is being tested on a brake test dynamometer. Active braking action through the ESP<sup>®</sup> may otherwise seriously damage the brake system which is not covered by the Mercedes-Benz Limited Warranty.

#### Vehicles without 4MATIC:

Because the ESP<sup>®</sup> operates automatically, the engine and ignition must be shut off

## Driving instructions

(SmartKey in starter switch position **0** or **1** or KEYLESS-GO start/stop button in position **0** or **1**) when the parking brake is being tested on a brake test dynamometer or the vehicle is being towed with the front axle raised.

Active braking action through the ESP<sup>®</sup> may otherwise seriously damage the brake system which is not covered by the Mercedes-Benz Limited Warranty.

If your brake system is normally only subjected to moderate loads, you should occasionally test the effectiveness of the brakes by applying above-normal braking pressure at higher speeds. This will also enhance the grip of the brake pads.

 **Warning!**

Make sure not to endanger any other road users when carrying out these braking maneuvers.

Refer to the description of the Brake Assist System (BAS) (> page 72).

### High-performance brake system

The high-performance brake system is only available on E 63 AMG.

 **Warning!**

New vehicle brake pads and discs, and replacement brake pads and discs may take several hundred miles of driving until they provide optimum braking efficiency. Until that time, you may need to use increased brake pedal pressure while braking. Please be aware of this and adjust your driving and braking accordingly during this break-in period.

Excessive high-demand braking will cause correspondingly high brake wear. Please be attentive to the brake warning lamp in the instrument cluster and brake condition messages in the multifunction display. Especially for high performance driving, it is important to maintain and have the brake system checked regularly.

The high-performance brake system is designed to operate under the extremely high operating demands required to accommodate the performance capabilities of the vehicle.

The brakes may produce a squeaking-type noise depending on the

- vehicle speed
- brake force applied
- ambient conditions, e.g. temperature and humidity

As with any brake system, the wear of individual brake system components such as brake pads or disks strongly depends on your driving style and the conditions under which you operate the vehicle. Thus, a driving style calling for high-demand braking will cause your vehicle's brakes to wear more quickly.

### Driving off

Warm up the engine smoothly. Do not place full load on the engine until the operating temperature has been reached.

 When driving off on a slippery surface, do not allow a drive wheel to spin for an extended period with the ESP<sup>®</sup> switched off. Doing so may cause serious damage to the drivetrain which is not covered by the Mercedes-Benz Limited Warranty.

 Simultaneously depressing the accelerator pedal and applying the brakes



## Driving instructions

reduces engine performance and causes premature brake and drivetrain wear which is not covered by the Mercedes-Benz Limited Warranty.

### Hydroplaning

Depending on the depth of the water layer on the road, hydroplaning may occur, even at low speeds and with new tires. In heavy rain or when conditions indicate possible hydroplaning:

- ▶ Reduce vehicle speed.
- ▶ Avoid track grooves in the road.
- ▶ Apply brakes cautiously.

### Standing water

**!** Do not drive through flooded areas. Before driving through water, determine its depth.

If you must drive through standing water, drive slowly to prevent water from entering the passenger compartment or the engine compartment. Water in these areas could cause damage to electrical components or wiring of the engine or transmission, or could result in water being ingested by the engine through the air intake causing severe internal engine damage. Any such damage is not covered by the Mercedes-Benz Limited Warranty.

### Driving abroad

If you plan to drive the vehicle outside the U.S. or Canada, you should request dealer network information for your destination from any authorized Mercedes-Benz Center.

### Control and operation of radio transmitter

#### Safety notes

#### **Warning!**

Please do not forget that your primary responsibility is to drive the vehicle. A driver's attention to the road must always be his/her primary focus when driving. For your safety and the safety of others, we recommend that you pull over to a safe location and stop before placing or taking a telephone call.

If you choose to use the telephone<sup>16</sup> while driving, please use the hands-free device and only use the telephone when road, weather and traffic conditions permit. Some jurisdictions prohibit the driver from using a mobile telephone while driving a vehicle.

<sup>16</sup> Observe all legal requirements.



## Driving instructions

Only operate the COMAND<sup>16</sup> (Cockpit Management and Data System) if road, weather and traffic conditions permit. Otherwise, you may not be able to observe traffic conditions and could endanger yourself and others.

Bear in mind that at a speed of just 30 mph (approximately 50 km/h), your vehicle is covering a distance of 44 feet (approximately 14 m) every second.

### Telephones and two-way radios

#### **Warning!**

Never operate radio transmitters equipped with a built-in or attached antenna, such as a portable telephone or a citizens band unit, from inside the vehicle while the engine is running. Doing so could lead to a malfunction of the vehicle's electronic system, possibly resulting in an accident and/or serious personal injury. Radio transmitters should only be used inside the vehicle if they are connected to an antenna that is installed on the outside of the vehicle.

Refer to the radio transmitter operation instructions regarding use of an external antenna.

#### **Emission control**

Certain systems of the engine serve to keep the toxic components of the exhaust gases within permissible limits required by law.

These systems will function properly only when maintained strictly according to factory specifications. Any adjustments on the engine should, therefore, be carried out only by qualified Mercedes-Benz Center authorized technicians.

Engine adjustments should not be altered in any way. Moreover, the specified service procedures must be carried out regularly according to Mercedes-Benz servicing requirements. For details refer to the Maintenance Booklet.

#### **Warning!**

Inhalation of exhaust gas is hazardous to your health. All exhaust gas contains carbon monoxide (CO), and inhaling it can cause unconsciousness and possible death.

Do not run the engine in confined areas (such as a garage) which are not properly ventilated. If you think that exhaust gas fumes are entering the vehicle while driving, have the cause determined and corrected immediately. If you must drive under these conditions, drive only with at least one window fully open at all times.

<sup>16</sup> Observe all legal requirements.

## Maintenance

### Maintenance

#### Notes

The Maintenance System in your vehicle tracks the distance driven and the time elapsed since the last maintenance service, calculates other maintenance service work required, and calls for the next maintenance service accordingly.

We strongly recommend that you have your vehicle serviced at an authorized Mercedes-Benz Center, in accordance with the Maintenance Booklet at the times called for by the maintenance service indicator.

**i** Failure to have the vehicle maintained in accordance with the Maintenance Booklet and maintenance service indicator at the designated times/mileage will result in vehicle damage not covered by the Mercedes-Benz Limited Warranty.

### Maintenance service indicator message

The maintenance service indicator message will notify you when the next maintenance service is due.

Starting approximately 1 month before the next maintenance service is due, one of the following messages will appear in the multifunction display while you are driving or when you switch on the ignition (example service A):

Service A Due In XXXX Miles (Km)

Service A Due In XXX Days

Service A Due In X Day

Service A Due Now



The maintenance services will be indicated by showing a service type A through type H in the multifunction display. Types A through H are classified based on estimated time needed to perform the maintenance service, ranging: from Service A

(approximately 1 hour)  
to Service H  
(approximately 8 hours)

Refer to Maintenance Booklet for a listing of maintenance services and intervals they need to be performed at.

### Clearing the maintenance service indicator message

The maintenance service indicator message is cleared automatically

- after approximately 10 seconds when you switch on the ignition
- after approximately 10 seconds when reaching the service threshold while driving
- after approximately 30 seconds, once the suggested maintenance service term has passed



① Reset button

► **Clearing the maintenance service indicator message manually:** Press reset button ① on the instrument cluster. The standard display appears in the multifunction display.

### Maintenance service term exceeded

If you have exceeded the suggested maintenance service term, you will see the following message in the multifunction display:

Service A Exceeded By XXXXX Miles (Km)

Service A Exceeded By XXX Days

Service A Exceeded By X Day

In addition, a signal sounds when the message appears.

Any authorized Mercedes-Benz Center will reset the maintenance service indicator following a completed maintenance service.

### Calling up the maintenance service indicator display

❶ The menu overview can be found on (▷ page 142).

You can call up the maintenance service indicator display at any time to check when the next maintenance service is due.

- Switch on the ignition.
- Press button or on the multifunction steering wheel repeatedly until the standard display (▷ page 143) appears in the multifunction display.
- Press button or on the multifunction steering wheel until the maintenance service indicator display with the service symbol and the maintenance service deadline appears in the multifunction display.

❶ If the battery is disconnected, the days of disconnection will not be included in the count shown by the maintenance service

indicator. To arrive at the true maintenance service deadline, you will need to subtract these days from the days shown in the maintenance service indicator message or maintenance service indicator display.

Do not confuse the maintenance service indicator with the engine oil level indicator



### Resetting the maintenance service indicator

In the event that the maintenance service on your vehicle is not carried out at an authorized Mercedes-Benz Center, you can have the maintenance service indicator reset.

The automotive maintenance facility carrying out the maintenance service will find the information for resetting the maintenance service indicator in the maintenance-relevant literature for your vehicle.

Such literature is available from any authorized Mercedes-Benz Center or directly from Mercedes-Benz.

❶ If the maintenance service indicator was inadvertently reset, have an authorized Mercedes-Benz Center correct it.

Only reset if the proper maintenance service has been performed. Resetting the



## Vehicle care

system without performing the proper maintenance service as called for by the maintenance service indicator will result in engine damage and/or other vehicle damage not covered by the Mercedes-Benz Limited Warranty.

### Vehicle care

#### Cleaning and care of the vehicle

##### Notes

Regular and proper care will help to maintain the value of your vehicle.

##### **Warning!**

Many cleaning products can be hazardous. Some are poisonous, others are flammable. Always follow the instructions on the particular container. Always open your vehicle's doors or windows when cleaning the inside.

Never use fluids or solvents that are not designed for cleaning your vehicle.

Always lock away cleaning products and keep them out of reach of children.

 When cleaning the vehicle, do not use scouring agents. Never apply strong force and only use a soft, wet cloth or sponge. Otherwise you may scratch or damage the surface to be cleaned.

While in operation, even while parked, your vehicle is subjected to varying external influences which, if gone unchecked, can attack the paintwork as well as the vehicle underbody and cause lasting damage.

Such damage is caused not only by extreme and varying climatic conditions, but also by:

- Air pollution
- Road salt
- Tar
- Gravel and stone chipping

To avoid paint damage, you should immediately remove:

- Grease and oil
- Fuel
- Coolant
- Brake fluid
- Bird droppings
- Insects
- Tree resins etc.

Frequent washing reduces and/or eliminates the aggressiveness and potency of the above adverse influences.

More frequent washings are necessary to deal with unfavorable conditions:

- near the ocean
- in industrial areas (smoke, exhaust emissions)
- during winter operation

You should check your vehicle from time to time for stone chipping or other damage. Any damage should be repaired as soon as possible to prevent corrosion.

In doing so, do not neglect the underbody of the vehicle. A prerequisite for a thorough check is a washing of the underbody followed by a thorough inspection. Damaged areas need to be re-undercoated.

Your vehicle has been treated at the factory with a wax-base rustproofing in the body cavities which will last for the lifetime of the vehicle. Post-production treatment is neither necessary nor recommended by Mercedes-Benz because of the possibility of incompatibility between materials used in the production process and others applied later.

We have selected vehicle-care products and compiled recommendations which are specially matched to our vehicles and which always reflect the latest technology. You can obtain Mercedes-Benz approved vehicle-care products at an authorized Mercedes-Benz Center.

Scratches, corrosive deposits, corrosion or damage due to negligent or incorrect care cannot always be removed or repaired with the vehicle-care products recommended

here. In such cases it is best to seek aid at an authorized Mercedes-Benz Center.

The following topics deal with the cleaning and care of your vehicle and give important “how-to” information as well as references to Mercedes-Benz approved vehicle-care products.

### Power washer

**!** Follow the instructions provided by the power washer manufacturer on maintaining a distance between the vehicle and the nozzle of the power washer.

Never use a round nozzle to power-wash tires. The intense jet of water can result in damage to the tire.

Always replace a damaged tire.

Always keep the jet of water moving across the surface. Do not aim directly at electrical parts, electrical connectors, seals, or other rubber parts.

**i** Vehicles with KEYLESS-GO:  
If a door handle is hit by a strong jet of water, and a SmartKey is within approximately 3 ft (1 m) of the vehicle, it could be inadvertently locked or unlocked.

### Tar stains

Quickly remove tar stains before they dry and become more difficult to remove. A tar remover is recommended.

### Paintwork, painted body components

**!** Affixing stickers, magnets, adhesive tape or similar materials to painted body components may damage the paintwork.

Mercedes-Benz approved Paint Care should be applied when water drops on the paint surface do not “bead up”. This should normally be done every 3 to 5 months, depending on the climate and washing detergent used.

Mercedes-Benz approved Paint Cleaner should be applied if the paint surface shows signs of embedded dirt (i.e. loss of gloss).

Do not apply any of these products or wax if your vehicle is parked in the sun or if the hood is still hot.

► Use the appropriate MB-Touch-Up Stick for quick and provisional repairs of minor paint damage (i.e. chips from stones, vehicle doors, etc.).

## Vehicle care

### Engine cleaning

Prior to cleaning the engine compartment, make sure to protect electrical components and connectors from contact with water and cleaning agents.

Corrosion protection, such as MB Anticorrosion Wax should be applied to the engine compartment after every engine cleaning. Before applying, all control linkage bushings and joints should be lubricated. The poly-V-belt and all pulleys should be protected from any wax.

### Vehicle washing

In the winter, thoroughly remove all traces of road salt as soon as possible.

When washing the vehicle underbody, do not forget to clean the inner sides of the wheels.

- i** Vehicles with KEYLESS-GO: If a door handle is hit by a strong jet of water, and a SmartKey is within approximately 3 ft (1 m) of the vehicle, it could be inadvertently locked or unlocked.

### Hand-wash

- ▶ Do not use hot water or wash your vehicle in direct sunlight.
- ▶ Only use a soft, wet cloth or sponge to clean the vehicle.
- ▶ Only use a mild vehicle wash detergent, such as Mercedes-Benz approved Car Shampoo.
- ▶ Thoroughly spray the vehicle with a diffused jet of water.
- ▶ Do not spray directly towards the ventilation intake.
- ▶ Use plenty of water and rinse the sponge and chamois frequently.
- ▶ Rinse with clean water and thoroughly dry with a chamois.

Do not allow cleaning agents to dry on the finish.

### Automatic car wash

You can have your vehicle washed in an automatic car wash from the start. Brushless car washes are preferable.

- ▶ To protect the filter system, activate the air recirculation mode using button  on the climate control panel.

- !** Do not clean your vehicle in an automatic touchless car wash which uses caustic spray. Caustic spray will damage the paint or ornamental moldings.

If the vehicle is very dirty, prewash it before running it through the automatic car wash.

- !** Make sure the combination switch is set to wiper setting **0**. Otherwise, the rain sensor could activate and cause the wipers to move unintentionally. This may lead to vehicle damage.

Due to the width of the vehicle, fold in exterior rear view mirrors prior to running the vehicle through an automatic car wash to prevent damage to the mirrors.

When leaving the automatic car wash, make sure the mirrors are folded out.

After running the vehicle through an automatic car wash, wipe any wax off of the windshield and the wiper blade inserts. This will prevent smears and reduce wiping noise which can be caused by residual wax on the windshield.

### Ornamental moldings

- ▶ For regular cleaning and care of ornamental moldings, use a damp cloth.

**!** Do not use chrome cleaner on ornamental moldings. Although ornamental moldings may have chrome appearance, they could be made of anodized aluminum that will be damaged when cleaned with chrome cleaner. Instead, use a damp cloth to clean those ornamental moldings.

For very dirty ornamental moldings of which you are sure are chrome-plated, use a chrome cleaner. If in doubt whether an ornamental molding is chrome-plated, contact an authorized Mercedes-Benz Center.

### Headlamps, brake lamps, tail lamps, side markers, turn signal lenses

- ▶ Use a mild vehicle wash detergent, such as Mercedes-Benz approved Car Shampoo, with plenty of water.

**!** Only use window cleaning solutions that are suitable for plastic lamp lenses. Window cleaning solutions which are not suitable may damage the plastic lamp lenses of the headlamps. Therefore, do not use abrasives, solvents or cleaners that contain solvents.

### Cleaning the Distronic system sensor cover



① Distronic system sensor cover

- ▶ Switch off the ignition.
- ▶ Only clean sensor cover ① by hand.
- ▶ Use a mild vehicle wash detergent, such as Mercedes-Benz approved Car Shampoo, with plenty of water and a non-scratching cloth to clean sensor cover ①.
- ▶ Restart the engine after cleaning sensor cover ①.

### Cleaning the Parktronic system sensors

Parktronic system sensors are located in the front and rear bumper.

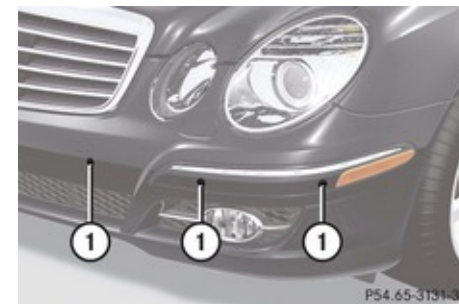

① Parktronic system sensors in front bumper

- ▶ Only clean sensors ① by hand.
- ▶ Use a mild vehicle wash detergent, such as Mercedes-Benz approved Car Shampoo, with plenty of water and a soft, non-scratching cloth to clean sensors ① on the bumpers.

**!** Applying strong pressure may damage the sensor covers.

### Cleaning the windows and the wiper blades

**!** The windshield wipers must be in a vertical position before folding them away from the windshield. They could otherwise damage the hood.



## Vehicle care

Never open the hood when the wiper arms are folded forward.

- ▶ Make sure the hood is fully closed.
- ▶ Switch on the ignition.
- ▶ Turn combination switch to wiper setting  (> page 118).
- ▶ With wiper arms in vertical position, switch off the ignition.

### **Warning!**

For safety reasons, switch off wipers and remove SmartKey from starter switch (vehicles with KEYLESS-GO: Make sure the vehicle's on-board electronics have status **O**) before cleaning the windshield and/or the wiper blades. Otherwise, the wiper motor could suddenly turn on and cause injury.

-  Do not pull on the wiper blade inserts. They could tear.

- ▶ Fold the wiper arms forward until they snap into place.
- ▶ Clean the windshield and the wiper blade inserts with a clean cloth and mild detergent solution.
- ▶ Use a soft, clean cloth and a mild window cleaning solution on all outside and inside glass surfaces.  
An automotive glass cleaner is recommended.

-  Fold the windshield wiper arms back onto the windshield before turning the SmartKey in the starter switch or pressing the KEYLESS-GO start/stop button (vehicles with KEYLESS-GO).

Hold on to the wiper when folding the wiper arm back. If released, the force of the impact from the tensioning spring could crack the windshield.

-  To clean the window interior, do not use a dry cloth, abrasives, solvents or cleaners containing solvents. Do not touch the inside of the front, rear or side windows with hard objects such as an ice scraper or ring. Doing so may damage the windows.

## Cleaning the panorama roof with power tilt/sliding panel (sedan)

---

- ▶ Use a soft, clean cloth and a mild window cleaning solution.

An automotive glass cleaner is recommended.

-  Do not use a dry cloth, abrasives, solvents or cleaners containing solvents. Doing so may damage the tilt/sliding panel.

## Light alloy wheels

---

If possible, clean wheels once a week.

- ▶ Use Mercedes-Benz approved Wheel Care, a soft bristle brush and a strong spray of water for cleaning the light alloy wheels.

-  Only use acid-free cleaning materials. Acid may cause corrosion or damage the clear coat.

-  The vehicle should not be parked for an extended period of time immediately after it has been cleaned, especially not after the wheel rims have been cleaned with wheel rim cleaner. Wheel rim cleaners can lead to increased corrosion of the brake disks and brake pads. Non-approved wheel cleaners



may also damage the wheel paint if the vehicle is not driven after cleaning.

Therefore, the vehicle's brake system should always be warmed-up before it is parked after cleaning. Drive your vehicle for several minutes to allow the brakes to dry. When applying Mercedes-Benz approved Tire Care and Mercedes-Benz approved Wheel Care products, take care not to spray them on the brake disks.

### Plastic and rubber parts

- ▶ Use a gentle dishwashing detergent or mild detergent for delicate fabrics as a washing solution.
- ▶ Wipe with a cloth moistened in a lukewarm solution.  
The surface may temporarily change color. If this is the case, wait for it to dry.

#### **Warning!**

Do not use cleaners or cockpit care sprays containing solvents to clean the cockpit or the steering wheel. Cleaners containing solvents will make the surface porous and vehicle occupants could suffer serious injuries from plastic parts coming loose in the event of air bag deployment.

- ❗ Do not use oil, wax or scouring agents. Otherwise you may scratch or damage the surface.

### Hard plastic trim items

- ▶ Use Mercedes-Benz approved Interior Care on a soft, lint-free cloth and apply with light pressure.

### COMAND display

- ❗ You must switch off the COMAND display and allow it to cool prior to cleaning.
- ❗ Do not use any liquids or cleaning agents. These can damage or even destroy the audio display screen.
- ▶ Use a standard microfiber cloth and apply with light pressure.

### Steering wheel and gear selector lever

- ▶ Wipe with a damp cloth and dry thoroughly or clean with Mercedes-Benz approved Leather Care.

### Carpets

- ▶ Use Mercedes-Benz approved Carpet and Fabric Care for cleaning the carpets.

### Headliner and shelf below rear window

- ▶ Use a soft bristle brush or a dry-shampoo cleaner in case of excessive dirt.

### Seat belts

- ▶ Only use clear, lukewarm water and soap.

- ❗ The seat belts must not be treated with chemical cleaning agents. Do not dry the seat belts at temperatures above 176°F (80°C) or in direct sunlight.

#### **Warning!**

Do not bleach or dye seat belts as this may severely weaken them. In a crash they may not be able to provide adequate protection.

### Upholstery

Using aftermarket seat covers or wearing clothing that have the tendency to give off coloring (e.g. when wet, etc.) may cause the upholstery to become permanently discolored. By lining the seats with a proper



## Vehicle care

intermediate cover, contact-discoloration will be prevented.

### **Warning!**

Only use seat or head restraint covers which have been tested and approved by Mercedes-Benz for your vehicle model.

Using other seat or head restraint covers may interfere with or prevent the activation of the active head restraints and/or the deployment of the front side impact air bags.

Contact an authorized Mercedes-Benz Center for availability.

### **Leather upholstery**

Please note that leather upholstery is a natural product and is therefore subject to a natural aging process. Leather upholstery may also react to certain ambient influences such as high humidity or high temperature by showing wrinkles for example.

- ▶ Wipe leather upholstery with a damp cloth and dry thoroughly or clean with Mercedes-Benz approved Leather Care.

- ❗ To avoid damage to leather upholstery:
  - Wipe with light pressure only.
  - Do not clean with abrasive cleaning agents such as scouring milk or powder.

- Do not soak the leather upholstery. As leather is a natural product, it could otherwise harden or become porous.
- Exercise particular care when cleaning perforated leather as its underside should not become wet.

### **MB Tex upholstery**

- ▶ Use Mercedes-Benz approved Interior Care onto a soft, lint-free cloth and apply with light pressure for cleaning the upholstery.

### **Wood trims**

- ▶ Only use water and a damp cloth to clean wood trims in your vehicle.

- ❗ Do not use solvents like tar remover or wheel cleaner nor polishes or waxes as these may be abrasive.

### **Chrome-plated exhaust tip**

Regular cleaning and care of chrome-plated exhaust tips will help to maintain their shine and the classy appearance.

- ▶ Use Mercedes-Benz approved Chrome Polishing Paste each time the vehicle has been washed, especially during the winter.

- ❗ Do not use alkaline cleaners such as wheel cleaners as they could cause corrosion.

Vehicle equipment .....	290
Where will I find ...? .....	290
Vehicle status messages in the multifunction display .....	295
What to do if ... .....	330
Unlocking/locking manually .....	343
Resetting activated head restraints	345
Replacing SmartKey batteries .....	346
Replacing bulbs .....	348
Replacing wiper blades .....	352
Flat tire .....	355
Bleeding the fuel system (diesel engine only) .....	366
Battery .....	367
Jump starting .....	369
Towing the vehicle .....	372
Fuses .....	375



### Where will I find ...?

#### Vehicle equipment

**i** This Operator's Manual describes all features, standard or optional, potentially available for your vehicle at the time of purchase. Please be aware that your vehicle might not be equipped with all features described in this manual.

#### Where will I find ...?

##### First aid kit

**!** Always keep the storage compartment under the front passenger seat closed while the vehicle is in motion.

**i** Check expiration dates and contents for completeness at least once a year and replace missing/expired items.

The first aid kit is located in the storage compartment under the front passenger seat.



① Handle

- ▶ Pull handle ① upward.
- ▶ Fold the lid down.
- ▶ Remove the first aid kit.

##### Vehicle tool kit

The vehicle tool kit is located

- underneath the trunk floor (sedan)
- underneath the cargo compartment floor (wagon without third-row seats)
- underneath the third-row seats' footwell (wagon with third-row seats)

The vehicle tool kit includes:

- Alignment bolt
- Collapsible wheel chock
- Electric air pump<sup>17</sup>
- Pair of gloves
- Pair of universal pliers
- TIREFIT kit<sup>18</sup>
- Towing eye bolt

<sup>17</sup> Vehicles with TIREFIT or spare wheel with collapsible tire only.

<sup>18</sup> E 63 AMG wagon with folding third-row seats only.

Where will I find ...?

- Valve extractor<sup>19</sup>
- Wheel wrench

**Vehicle tool kit (sedan)**

- ▶ **Removing:** Open the trunk (▷ page 86).
- ▶ Lift the trunk floor using the floor handle.
- ▶ Engage the floor handle on the upper trunk lip.

**!** To prevent damage, always disengage the floor handle from the upper trunk lip and lower the trunk floor before closing the trunk.

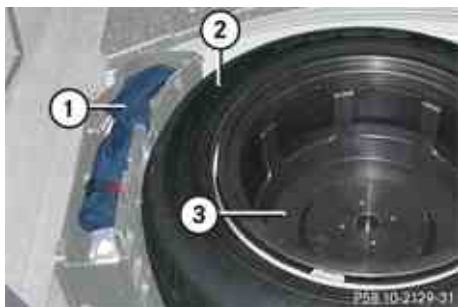

- ① Tool bag and jack
- ② Spare wheel
- ③ Luggage bowl

<sup>19</sup> Vehicles with spare wheel with collapsible tire only.

- ▶ **To access jack:** Remove tool bag ①.

**Vehicle tool kit (wagon)**

- ▶ **Removing:** Open the tailgate (▷ page 86).

**Wagon without third-row seats**

- ▶ Open the rear cargo compartment floor (▷ page 214).

**Wagon with third-row seats**

- ▶ Fold out the third-row seats (▷ page 103).
- ▶ Remove the seat cushions of the third-row seats (▷ page 103).



- ① Footwell handle
- ② Footwell

- ▶ **Opening:** Lift footwell ② using footwell handle ①.
- ▶ **Closing:** Close footwell ② and push it down until it engages.

**Vehicles with spare wheel**



- ① Handle
- ② Cover

- ▶ Turn handle ① to the right as far as it will go.
- ▶ Remove cover ②.

### Where will I find ...?

#### Vehicles with TIREFIT

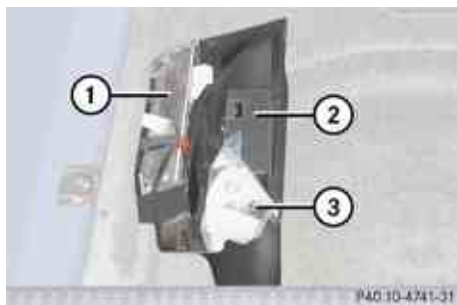

- ① Jack and tools
- ② Electric air pump
- ③ TIREFIT kit

► **To access remaining tools:** Remove jack ①.

#### Collapsible wheel chock

The collapsible wheel chock serves to secure the vehicle, e.g. while changing a wheel.

► Take the collapsible wheel chock from the vehicle tool kit (► page 290).



- ① Tilt the plates upward
- ② Fold the lower plate outward
- ③ Insert the plate

- **Setting up:** Tilt both plates upward ①.
- Fold the lower plate outward ②.
- Guide the tabs of the lower plate all the way into the openings of base plate ③.

For information on where to place wheel chocks when changing a wheel, see “Lifting the vehicle” (► page 360).

#### Jack

##### **Warning!**

Only use the jack supplied with your vehicle to lift the vehicle briefly for wheel changes. If you use the jack for any other purpose,

you or others could be injured, as the jack is designed only for the purpose of changing a wheel.

When using the jack, observe the safety notes in the “Mounting the spare wheel” section and the notes on the jack.

- Take the jack from the vehicle tool kit (► page 290).

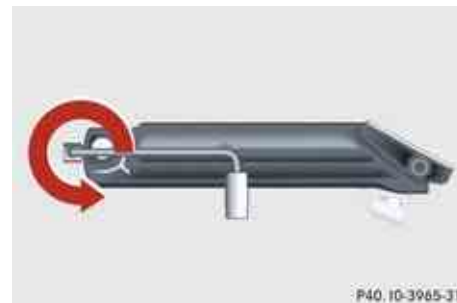

Storage position

- Turn the crank handle in the direction of arrow as far as it will go.

## Where will I find ...?

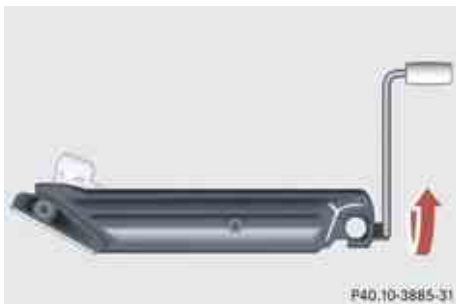

Operational position

- ▶ Turn the crank handle clockwise.

Before placing the jack back into the vehicle tool kit:

- ▶ Fully collapse the jack.
- ▶ Fold in the crank handle (storage position).

### Spare wheel

**⚠ Observe Safety notes, see page 355.**

The spare wheel is located underneath the trunk floor (sedan)/cargo compartment floor (wagon).

- ▶ **Removing:** To access the spare wheel, proceed as described in the section on the vehicle tool kit (▶ page 290).

### Vehicles with Minispare wheel

- ▶ **Sedan:** Remove the luggage box (▶ page 294).

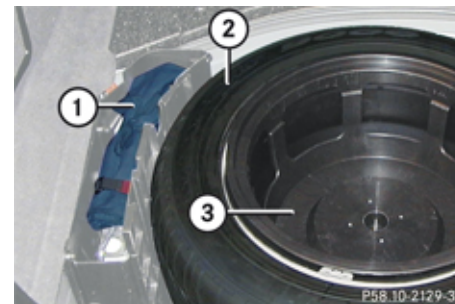

Example illustration (sedan)

- ① Tool bag and jack
- ② Spare wheel
- ③ Luggage bowl

- ▶ Remove luggage bowl ③ by turning it counterclockwise.
- ▶ Remove spare wheel ②.

For information on mounting the spare wheel, see “Flat tire” (▶ page 355).

### Storing the spare wheel after use

- ▶ Place spare wheel ② in the spare wheel well (▶ page 293).
- ▶ Secure spare wheel ② by turning luggage bowl ③ clockwise (▶ page 293).

### Where will I find ...?

#### Vehicles with spare wheel with collapsible tire



- ① Tool bag and jack
- ② Spare wheel
- ③ Electric air pump
- ④ Protective film/bag
- ⑤ Storage well casing

**i** For transporting the damaged road wheel, use protective film/bag ④ (if available).

- ▶ Remove storage well casing ⑤.



- ⑥ Retaining screw
- ⑦ Storage well casing base

- ▶ Remove storage well casing base ⑦.
- ▶ Remove retaining screw ⑥ by turning it counterclockwise.
- ▶ Remove spare wheel ②.

For information on mounting the spare wheel, see “Flat tire” (▶ page 355).

#### Storing the spare wheel after use

If you wish to store the spare wheel after use, carry out the following steps. Otherwise, the spare wheel may not fit the spare wheel well.

**!** Make sure the spare wheel is dry before storing it.

- ▶ Unscrew the valve cap from the valve of the collapsible tire.
- ▶ Unscrew the valve insert from the valve using the valve extractor integrated in the valve cap.
- ▶ Allow the air to escape.

**i** It may take a few minutes for the collapsible tire to deflate completely.

- ▶ Screw the valve insert back into the valve.
- ▶ Screw the valve cap back onto the valve.
- ▶ Place spare wheel ② into the spare wheel well (▶ page 294).
- ▶ Secure spare wheel ② by turning retaining screw ⑥ clockwise (▶ page 294).

#### Luggage box (sedan)

Vehicles with spare wheel with collapsible tire are not equipped with a luggage box.

- ▶ **Removing:** Open the trunk (▶ page 86).
- ▶ Lift the trunk floor using the floor handle.
- ▶ Engage the floor handle on the upper trunk lip.

**!** To prevent damage, always disengage the floor handle from the upper trunk lip and



## Vehicle status messages in the multifunction display

lower the trunk floor before closing the trunk.

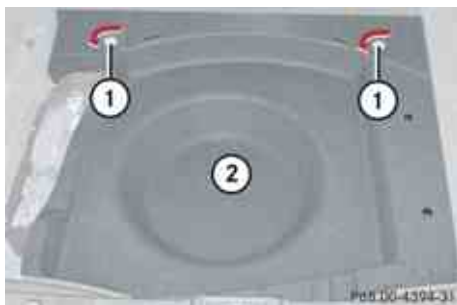

① Fastening clip

② Luggage box

- ▶ Turn fastening clips ① to the left upwards from the fastening bolts.
- ▶ Lift luggage box ② in the area of the fastening bolts and remove it from the trunk.
- ▶ **Installing:** Insert the luggage box into the trunk so that the fastening clips are in line with the fastening bolts.



- ▶ Push the front edge of the luggage box in direction of arrows under the cover of the trunk sill.
- ▶ Press the fastening clips onto the fastening bolts until they lock into place.

### Vehicle status messages in the multifunction display

#### Notes

Warning and malfunction messages appear in the multifunction display located in the instrument cluster.

Certain warning and malfunction messages are accompanied by an audible signal.





Address these messages accordingly and follow the additional instructions given in this Operator's Manual.

Selecting the **Vehicle status message memory** menu in the control system (▶ page 148) displays both cleared and uncleared messages.

High-priority messages appear in the multifunction display in red color.

Certain messages of high priority cannot be cleared from the multifunction display using the reset button (▶ page 138) or button

, ,  or  on the multifunction steering wheel.

Other messages of high priority and messages of less immediate priority can be cleared from the multifunction display using the reset button or button , ,  or  on the multifunction steering wheel



### Vehicle status messages in the multifunction display

wheel. They are then stored in the **Vehicle status message memory** menu (▷ page 148). Remember that clearing a message will only make the message disappear. Clearing a message will not correct the condition that caused the message to appear.

#### **Warning!**

All categories of messages contain important information which should be taken note of and, where a malfunction is indicated, addressed as soon as possible at an authorized Mercedes-Benz Center.

Failure to repair the condition noted may cause damage not covered by the Mercedes-Benz Limited Warranty, or result in property damage or personal injury.

#### **Warning!**

No messages will be displayed if either the instrument cluster or the multifunction display is inoperative.

As a result, you will not be able to see information about your driving conditions, such as speed or outside temperature,

warning/indicator lamps, malfunction/warning messages or the failure of any systems. Driving characteristics may be impaired.

If you must continue to drive, please do so with added caution. Contact an authorized Mercedes-Benz Center as soon as possible.

On the pages that follow, you will find a compilation of the most important warning and malfunction messages that may appear in the multifunction display.

For your convenience the messages are divided into text messages (▷ page 297) and symbol messages (▷ page 312).

## Vehicle status messages in the multifunction display

## Text messages

## Safety systems

Display messages		Possible cause/consequence	Possible solution
ABS	ABS, ESP Inoperative See Operator's Man.	The brake system is still functioning normally but due to a malfunction, the ABS, the BAS, the ESP® and the PRE-SAFE® system are unavailable.	<ul style="list-style-type: none"> <li>▶ Continue driving with added caution. Wheels may lock during hard braking, reducing steering capability.</li> <li>▶ Have the system checked at an authorized Mercedes-Benz Center as soon as possible.</li> </ul> <p>Failure to follow these instructions increases the risk of an accident.</p>
ABS	ABS, ESP Unavailable See Operator's Man.	The brake system still functions normally but due to insufficient power supply, the ABS, the BAS, the ESP® and the PRE-SAFE® system are unavailable.	<p>When the voltage is above the required value again, the ABS, the BAS, the ESP® and the PRE-SAFE® system are operational again and the message should disappear.</p> <ul style="list-style-type: none"> <li>▶ If the message does not disappear: Have the system checked at an authorized Mercedes-Benz Center as soon as possible.</li> </ul>
ESP	Inoperative See Operator's Manual	The brake system is still functioning normally but due to a malfunction the BAS, the ESP® and the PRE-SAFE® system are unavailable.  The ABS may not be operational.	<ul style="list-style-type: none"> <li>▶ Continue driving with added caution. Wheels may lock during hard braking, reducing steering capability.</li> <li>▶ Have the system checked at an authorized Mercedes-Benz Center as soon as possible.</li> </ul> <p>Failure to follow these instructions increases the risk of an accident.</p>

### Vehicle status messages in the multifunction display



Display messages		Possible cause/consequence	Possible solution
PRE-SAFE	Inoperative See Operator's Manual	The PRE-SAFE® system itself has failed. All other occupant safety systems, such as the air bags, are still available.	► Contact an authorized Mercedes-Benz Center as soon as possible.

## Vehicle status messages in the multifunction display

Display messages	Possible cause/consequence	Possible solution
<p>Front Passenger Airbag Enabled See Operator's Manual</p>	<p>The front passenger front air bag is activated while driving even though a child, small individual, or object below the system's weight threshold is on the front passenger seat, or the front passenger seat is empty. Objects on the seat or forces acting on the seat may make the system sense supplemental weight.</p>	<ul style="list-style-type: none"> <li>▶ Stop the vehicle in a safe location as soon as possible.</li> <li>▶ Engage the parking brake.</li> <li>▶ Switch off the ignition.</li> <li>▶ Open the front passenger door.</li> <li>▶ Remove child and child restraint from front passenger seat and properly secure the child in rear seat employing the child restraint if necessary.</li> <li>▶ Remove any other items from on and around the front passenger seat and make sure the storage bag on the back of the front passenger seat is empty.</li> <li>▶ Make sure no objects which apply forces to the seat are present (e.g. objects such as books, briefcases etc. lodged behind or around the seat, head restraints pushing against roof etc.). The system may recognize such forces as supplemental weight and sense that an occupant on the front passenger seat is of a greater weight than actually present.</li> <li>▶ Keep the seat unoccupied, close the front passenger door and switch on the ignition.</li> </ul> <p>Monitor the  indicator lamp in the center console (▶ page 53) and the multifunction</p>





## Vehicle status messages in the multifunction display

Display messages	Possible cause/consequence	Possible solution
		<p>display in the instrument cluster (&gt; page 30) for the following:</p> <p>With the seat unoccupied and the ignition switched on,</p> <ul style="list-style-type: none"> <li>the <b>PASS AIR BAG OFF</b>  indicator lamp in the center console should illuminate and remain illuminated, indicating that the OCS (&gt; page 50) has deactivated the front passenger front air bag.</li> <li>the message <b>Front Passenger Airbag Enabled See Operator's Manual</b> or the message <b>Front Passenger Airbag Disabled See Operator's Manual</b> should not appear in the multifunction display at any time the seat is unoccupied. Wait at least 60 seconds for the system to complete the necessary check cycles and to make sure neither message appears in the multifunction display.</li> </ul> <p>If above conditions are met, you can occupy the front passenger seat again. Depending on the front passenger classification sensed by the OCS, the <b>PASS AIR BAG OFF</b>  indicator lamp will remain illuminated or go out.</p> <p>If above conditions are not met, the system is not working properly. Have the system checked as</p>





## Vehicle status messages in the multifunction display

Display messages	Possible cause/consequence	Possible solution
		soon as possible at an authorized Mercedes-Benz Center.

 **Warning!**

If the   indicator lamp remains out even after performing the above corrective steps, do not have any children 12 years old and under and other small individuals use the front passenger seat until the system has been repaired.

## Vehicle status messages in the multifunction display

Display messages	Possible cause/consequence	Possible solution
<p>Front Passenger Airbag Disabled See Operator's Manual</p>	<p>The front passenger front air bag is deactivated while driving even though an adult or someone larger than a small individual is occupying the front passenger seat. Forces acting on the seat may make the system sense a decrease in weight.</p>	<ul style="list-style-type: none"> <li>▶ Stop the vehicle in a safe location as soon as possible.</li> <li>▶ Engage the parking brake.</li> <li>▶ Switch off the ignition.</li> <li>▶ Have the front passenger vacate the seat and exit the vehicle.</li> <li>▶ Adjust the seat height to a higher position (▷ page 96).</li> <li>▶ Make sure no objects which apply forces to the seat are present (e.g. objects such as books, briefcases etc. lodged underneath, behind or around the seat). Such forces may cause the system to sense that an occupant of a lesser weight than actually present is on the front passenger seat.</li> <li>▶ Keep the seat unoccupied, close the front passenger door and switch on the ignition.</li> </ul> <p>Monitor the   indicator lamp in the center console (▷ page 53) and the multifunction display in the instrument cluster (▷ page 30) for the following:</p> <p>With the seat unoccupied and the ignition switched on,</p> <ul style="list-style-type: none"> <li>• the   indicator lamp in the center console should illuminate and remain illuminated, indicating that the OCS</li> </ul>



Vehicle status messages in the multifunction display

Display messages		Possible cause/consequence	Possible solution
			<p>(▷ page 50) has deactivated the front passenger front air bag.</p> <ul style="list-style-type: none"> <li>the message <b>Front Passenger Airbag Enabled See Operator's Manual</b> or the message <b>Front Passenger Airbag Disabled See Operator's Manual</b> should not appear in the multifunction display at any time the seat is unoccupied. Wait at least 60 seconds for the system to complete the necessary check cycles and to make sure neither message appears in the multifunction display.</li> </ul> <p>If above conditions are met, you can occupy the front passenger seat again. Depending on the front passenger classification sensed by the OCS, the <b>PASS AIR BAG OFF</b>  indicator lamp will remain illuminated or go out.</p> <p>If above conditions are not met, the system is not working properly. Have the system checked as soon as possible at an authorized Mercedes-Benz Center.</p>

 **Warning!**

If the **PASS AIR BAG OFF**  indicator lamp remains illuminated with an adult occupant on the front passenger seat even after performing the above corrective steps, do not have any passenger use the front passenger seat until the system has been repaired.

### Vehicle status messages in the multifunction display

#### Driving systems

Display messages		Possible cause/consequence	Possible solution
Cruise Control And SPEEDTRONIC	Inoperative	The cruise control is malfunctioning.	▶ Have cruise control checked at an authorized Mercedes-Benz Center.
Cruise Control	- - - MPH	One of the activation conditions for cruise control has not been fulfilled. For example, you have attempted to set a speed below 20 mph (30 km/h).	▶ Drive faster than 20 mph (30 km/h), if the situation allows, and set the speed. ▶ Check the activation conditions for cruise control (▷ page 161).
DISTRONIC	- - - MPH	One of the activation conditions for DISTRONIC has not been fulfilled. For example, you have attempted to set a speed below 20 mph (30 km/h).	▶ Drive faster than 20 mph (30 km/h), if the situation allows, and set the speed. ▶ Check the activation conditions for DISTRONIC (▷ page 166).
DISTRONIC	Inoperative	The DISTRONIC or the display are malfunctioning.	▶ Contact an authorized Mercedes-Benz Center as soon as possible.
DISTRONIC	Override	You have accelerated. The DISTRONIC has switched off.	▶ Stop accelerating.

## Vehicle status messages in the multifunction display

Display messages		Possible cause/consequence	Possible solution
DISTRONIC	Currently Unavailable See Operator's Manual	DISTRONIC is deactivated because: <ul style="list-style-type: none"> <li>• The DISTRONIC cover in the radiator grille is dirty.</li> <li>• The functionality is impaired by heavy precipitation or fog</li> <li>• The system is overheated.</li> </ul>	<ul style="list-style-type: none"> <li>▶ If necessary, clean the DISTRONIC cover in the area of the radiator grille (▷ page 285).</li> <li>▶ If necessary, wait until the system has cooled down.</li> <li>▶ Restart the vehicle.</li> </ul> DISTRONIC becomes operational again without the engine being restarted when: <ul style="list-style-type: none"> <li>• dirt on the radiator grille has fallen off while driving (e.g. slush or snow)</li> <li>• the system recognizes full sensor availability (due to lessening rain or the road surface drying)</li> <li>• the message in the multifunction display disappears</li> <li>• the speed last stored flashes in the display for 5 seconds.</li> </ul> You can then operate DISTRONIC as usual again.

### Vehicle status messages in the multifunction display

Display messages		Possible cause/consequence	Possible solution
DISTRONIC	Currently Unavailable See Operator's Manual	Distronic is deactivated because the functionality is impaired by external interferences, e.g. high-frequency sources such as toll stations, speed measuring systems etc.	<ul style="list-style-type: none"> <li>▶ Leave the area of the external interference.</li> <li>▶ Activate DISTRONIC again (▷ page 166) when the message in the multifunction display disappears.</li> </ul>
		Distronic is deactivated because the DISTRONIC sensor has not sensed any other vehicles or objects, e.g. road sign or such, for a long time.	<ul style="list-style-type: none"> <li>▶ Activate DISTRONIC again (▷ page 166) when the message in the multifunction display disappears.</li> </ul>

#### **Warning!**

Distronic cannot take weather conditions into account. Switch off DISTRONIC or do not turn it on if the sensor is dirty or visibility is diminished as a result of snow, rain or fog. The distance control may be impaired even before the system is able to detect a dirty sensor. The message DISTRONIC Currently Unavailable See Operator's Manual will be displayed in the multifunction display and DISTRONIC will be turned off.

## Vehicle status messages in the multifunction display

## Vehicle

Display messages		Possible cause/consequence	Possible solution
P	Gear Selector Lever In P Position	You have opened the driver's door while the engine was not running and the automatic transmission was not in park position <b>P</b> .	▶ Shift the automatic transmission into park position <b>P</b> .
		You have attempted to turn off the engine with the KEYLESS-GO start/stop button while the automatic transmission was not in park position <b>P</b> .	▶ Shift the automatic transmission into park position <b>P</b> .
P/N	Please Shift To N or P	You have attempted to start the engine with the KEYLESS-GO start/stop button while the automatic transmission was in reverse gear <b>R</b> or drive position <b>D</b> .	▶ Shift the automatic transmission into park position <b>P</b> or neutral position <b>N</b> . Make sure the brake pedal is depressed.

## Tires

Display messages		Possible cause/consequence	Possible solution
Check tires,	then restart Run Flat Indicator.	There has been a warning message about a loss in the tire inflation pressure and the Run Flat Indicator was not restarted yet.	▶ Make sure the correct tire inflation pressure is set for each tire. ▶ Then restart the Run Flat Indicator (> page 256).
Run Flat Indicator	Inoperative	The Run Flat Indicator is malfunctioning.	▶ Have the Run Flat Indicator checked at an authorized Mercedes-Benz Center.



### Vehicle status messages in the multifunction display

Display messages		Possible cause/consequence	Possible solution
Tire Pressure	Check tires	The Run Flat Indicator indicates that the pressure is too low in one or more tires.	<ul style="list-style-type: none"> <li>▶ Carefully bring the vehicle to a halt, avoiding abrupt steering and braking maneuvers. Observe the traffic situation around you.</li> <li>▶ Check the tires and, if necessary, change the wheel (▷ page 355).</li> <li>▶ Check and adjust tire inflation pressure as required (▷ page 255).</li> <li>▶ Restart the Run Flat Indicator after adjusting the tire inflation pressure values (▷ page 256).</li> </ul>
Tire pressure	is only displayed after driving for a few minutes.	Vehicles with Advanced TPMS (Canada only): The tire inflation pressure is being checked.	<ul style="list-style-type: none"> <li>▶ Drive the vehicle for a few minutes.</li> </ul>
Tire Pressure Monitor	Inoperative	The TPMS (USA only) or Advanced TPMS (Canada only) is malfunctioning.	<ul style="list-style-type: none"> <li>▶ Have the TPMS or Advanced TPMS checked at an authorized Mercedes-Benz Center.</li> </ul>
Tire Pressure Monitor	Inoperative No Wheel Sensors	There are wheels without appropriate wheel sensors mounted (e.g. winter tires).	<ul style="list-style-type: none"> <li>▶ Have the TPMS or Advanced TPMS checked at an authorized Mercedes-Benz Center.</li> <li>▶ Have the appropriate wheel sensors installed at an authorized Mercedes-Benz Center.</li> </ul>

## Vehicle status messages in the multifunction display

Display messages	Possible cause/consequence	Possible solution	
Tire Pres. Monitor	Wheel Sensor Missing	<p>Vehicles with Advanced TPMS (Canada only):</p> <p>One or more sensors are defect (e.g. battery is empty).</p> <p>The respective tire is indicated by – – instead of the tire inflation pressure in the multifunction display.</p>	<ul style="list-style-type: none"> <li>▶ Have the Advanced TPMS checked at an authorized Mercedes-Benz Center.</li> <li>▶ Have the wheel sensors installed at an authorized Mercedes-Benz Center.</li> </ul>
		<p>One or more wheels without appropriate wheel sensors mounted (e.g. spare tire).</p> <p>The respective tire is indicated by – – instead of the tire inflation pressure in the multifunction display.</p>	<ul style="list-style-type: none"> <li>▶ Have the Advanced TPMS checked at an authorized Mercedes-Benz Center.</li> <li>▶ Have the wheel sensors installed at an authorized Mercedes-Benz Center.</li> </ul>
Tire Pressure Monitor	Currently Unavailable	The TPMS (USA only) or Advanced TPMS (Canada only) is unable to monitor the tire inflation pressure due to a nearby radio interference source or insufficient power supply.	As soon as the causes of the malfunction have been removed, the TPMS or Advanced TPMS becomes active again automatically after a few minutes driving.

### Vehicle status messages in the multifunction display

Display messages	Possible cause/consequence	Possible solution
Please correct the tire pressure.	Vehicles with Advanced TPMS (Canada only): The tire pressure is too low in one or more tires. or The tire pressures of the individual tires differ from each other significantly. The tire pressure values are shown in the multifunction display.	▶ Check and correct tire inflation pressure as required (▷ page 255).
Caution Tire Pressure Tire Defect	Vehicles with Advanced TPMS (Canada only): One or more tires are deflating. The respective tire is indicated in the multifunction display.	▶ Carefully bring the vehicle to a halt, avoiding abrupt steering and braking maneuvers. ▶ If necessary, change the wheel (▷ page 355).
Check Tires	Vehicles with Advanced TPMS (Canada only): The tire pressure in one or more tires is already below the minimum value. The respective tire is indicated in the multifunction display.	▶ Carefully bring the vehicle to a halt, avoiding abrupt steering and braking maneuvers. ▶ Check and adjust tire pressure as required. ▶ If necessary, change the wheel (▷ page 355).

#### **Warning!**

Do not drive with a flat tire. A flat tire affects the ability to steer or brake the vehicle. You may lose control of the vehicle. Continued driving with a flat tire will cause excessive heat build-up and possibly a fire.



**Vehicle status messages in the multifunction display** **Warning!**

Follow recommended tire inflation pressures.

Do not underinflate tires. Underinflated tires wear excessively and/or unevenly, adversely affect handling and fuel economy, and are more likely to fail from being overheated.

Do not overinflate tires. Overinflated tires can adversely affect handling and ride comfort, wear unevenly, increase stopping distance, and result in sudden deflation (blowout) because they are more likely to become punctured or damaged by road debris, potholes etc.



## Vehicle status messages in the multifunction display

### Symbol messages

#### Brake

Display messages	Possible cause/consequence	Possible solution
	Brake Wear The brake pads have reached their wear limit.	▶ Have the brake pads replaced as soon as possible.

**!** Brake pad thickness must be visually inspected by a qualified technician at the intervals specified in the Maintenance Booklet.

Display messages	Possible cause/consequence	Possible solution
<b>BRAKE</b> (USA only)  (Canada only)	EBV, ABS, ESP Inoperative See Operator's Man.	▶ Continue driving with added caution. Wheels may lock during hard braking, reducing steering capability. ▶ Adjust driving to be consistent with reduced braking responsiveness. ▶ Have the system checked at an authorized Mercedes-Benz Center as soon as possible.
<b>BRAKE</b> (USA only)  (Canada only)	Release Parking Brake You are driving with the parking brake engaged.	▶ Release the parking brake.

## Vehicle status messages in the multifunction display

Display messages	Possible cause/consequence	Possible solution
<p><b>BRAKE</b> (USA only)</p> <p> (Canada only)</p>	<p>Check Brake Fluid Level</p> <p>There is insufficient brake fluid in the reservoir.</p>	<p>Risk of accident!</p> <ul style="list-style-type: none"> <li>▶ Stop the vehicle in a safe location or as soon as it is safe to do so.</li> <li>▶ Do <b>not</b> drive any further.</li> <li>▶ Contact an authorized Mercedes-Benz Center or call Roadside Assistance.</li> </ul> <p>Do not add brake fluid! This will not solve the problem.</p>



 **Warning!**

Driving with the message **Check Brake Fluid Level** displayed can result in an accident. Have your brake system checked immediately. Do not add brake fluid before checking the brake system. Overfilling the brake fluid reservoir can result in spilling brake fluid on hot engine parts and the brake fluid catching fire. You can be seriously burned.

**!** If you find that the brake fluid in the brake fluid reservoir has fallen to the minimum mark or below, have the brake system checked for brake pad thickness and leaks.

### Vehicle status messages in the multifunction display

#### Safety systems



Display messages	Possible cause/consequence	Possible solution
 SOS Tele Aid Inoperative	One or more main functions of the Tele Aid system are malfunctioning.	► Have the Tele Aid system checked at an authorized Mercedes-Benz Center.
 SRS Restraint System Malfunction Service Required	The system is malfunctioning.	► Drive with added caution to the nearest authorized Mercedes-Benz Center and have the system checked immediately.

#### **Warning!**



In the event a malfunction of the SRS is indicated as outlined above, the SRS may not be operational.

For your safety, we strongly recommend that you contact an authorized Mercedes-Benz Center immediately to have the system checked. Otherwise the SRS may not be activated when needed in an accident, which could result in serious or fatal injury, or it might deploy unexpectedly and unnecessarily which could also result in injury.



#### Driving systems

Display messages	Possible cause/consequence	Possible solution
 Vehicle Rising	Your vehicle is adjusting to your level selection.	
 Vehicle Rising Please Wait	The vehicle level is too low.	► Wait until the message disappears from the multifunction display.

Vehicle status messages in the multifunction display







Display messages	Possible cause/consequence	Possible solution
 <p>STOP Vehicle Too Low</p>	<p>The AIRMATIC DC is malfunctioning.</p>	<p>Avoid excessive steering maneuvers. The fenders or tires could otherwise be damaged. Listen for scraping noises.</p> <ul style="list-style-type: none"> <li>▶ Do not drive faster than 50 mph (80 km/h).</li> <li>▶ Drive to the side of the road and select a higher vehicle level (▶ page 172). Depending on the type of malfunction, this may raise the vehicle's level.</li> <li>▶ Contact an authorized Mercedes-Benz Center as soon as possible.</li> </ul> <p>There is otherwise danger of an accident.</p>
 <p>Malfunction</p>	<p>The system is functional only to a limited extent. The system display or the system is malfunctioning.</p>	<ul style="list-style-type: none"> <li>▶ Do not drive faster than 50 mph (80 km/h).</li> <li>▶ Have the vehicle checked at an authorized Mercedes-Benz Center.</li> </ul>

Vehicle





Display messages	Possible cause/consequence	Possible solution
	<p>The trunk is open (sedan).</p>	<ul style="list-style-type: none"> <li>▶ Close the trunk.</li> </ul>
	<p>The tailgate is open (wagon).</p>	<ul style="list-style-type: none"> <li>▶ Close the tailgate.</li> </ul>
	<p>You are driving with the hood open.</p>	<ul style="list-style-type: none"> <li>▶ Close the hood (▶ page 243).</li> </ul>



## Vehicle status messages in the multifunction display





Display messages	Possible cause/consequence	Possible solution
	You are driving with at least one door open. The display symbol shows you which doors are open.	▶ Close all doors.
 <p>Left Rear Backrest Not Locked or Right Rear Backrest Not Locked</p>	The rear seat backrest is not engaged.	▶ Adjust the rear seat backrest until it is fully engaged in position.
 <p>Key Detected In Vehicle</p>	A SmartKey with KEYLESS-GO left in the vehicle was recognized while trying to lock the vehicle from the outside.	▶ Take the SmartKey out of the vehicle.
 <p>Please don't forget your key.</p>	This display appears for a maximum of 60 seconds if the driver's door is opened with the engine turned off and no SmartKey in the starter switch. This message is only a reminder.	▶ Take the SmartKey with you when leaving the vehicle.
 <p>Remove Key</p>	You have forgotten to remove the SmartKey.	▶ Remove the SmartKey from the starter switch.
 <p>Please get a new key.</p>	The SmartKey is malfunctioning.	▶ Contact an authorized Mercedes-Benz Center.
 <p>Change Key Batteries</p>	The batteries in the SmartKey with KEYLESS-GO are discharged.	▶ Replace the batteries (▷ page 346).

## Vehicle status messages in the multifunction display

Display messages	Possible cause/consequence	Possible solution
 Key Not Detected	The SmartKey with KEYLESS-GO is not detected while the engine is running because the SmartKey is not in the vehicle.	<ul style="list-style-type: none"> <li>▶ Stop the vehicle as soon as it is safe to do so.</li> <li>▶ Engage the parking brake.</li> <li>▶ Search for the SmartKey.</li> </ul> <p>The vehicle cannot be locked centrally nor can the engine be started again after the engine is stopped.</p>
 Key Not Detected	The SmartKey with KEYLESS-GO is not detected while the engine is running because there is strong radio-frequency interference.	<ul style="list-style-type: none"> <li>▶ Stop the vehicle as soon as it is safe to do so.</li> <li>▶ Engage the parking brake.</li> <li>▶ Operate the vehicle with the SmartKey in the starter switch.</li> </ul>
 Key Not Detected	The SmartKey with KEYLESS-GO is momentarily not detected.	<ul style="list-style-type: none"> <li>▶ Change the position of the SmartKey in the vehicle.</li> <li>▶ Operate the vehicle with the SmartKey in the starter switch if necessary.</li> </ul>
 Bluetooth Ready	The telephone has not yet been connected to the COMAND system via Bluetooth®.	<ul style="list-style-type: none"> <li>▶ Connect the telephone to the COMAND system via Bluetooth®.</li> </ul>
 Top Up Washer Fluid	The fluid level has dropped to approximately $\frac{1}{3}$ of total reservoir capacity.	<ul style="list-style-type: none"> <li>▶ Add washer fluid (▷ page 246).</li> </ul>

### Vehicle status messages in the multifunction display

#### Engine

Display messages	Possible cause/consequence	Possible solution
 <p>check engine (USA only)</p>  <p>(Canada only)</p>	<p>Engine Service</p> <p>There may be a malfunction in:</p> <ul style="list-style-type: none"> <li>• The fuel management system</li> <li>• The ignition system (gasoline engine)</li> <li>• The exhaust system</li> <li>• The fuel system</li> </ul>	<p>► Have the engine checked as soon as possible at an authorized Mercedes-Benz Center.</p>
	<p>Display Malfunction Service Required</p> <p>Certain electronic systems are unable to relay information to the control system. The coolant temperature display or the tachometer may have failed.</p>	<p>► Have the electronic systems checked at an authorized Mercedes-Benz Center.</p>
	<p>Top Up Coolant See Operator's Man.</p> <p>The coolant level is too low.</p>	<p>► Add coolant (&gt; page 245).</p> <p>► If you have to add coolant frequently, have the cooling system checked at an authorized Mercedes-Benz Center.</p>

#### **Warning!**

Do not spill antifreeze on hot engine parts. Antifreeze contains ethylene glycol which may burn if it comes into contact with hot engine parts. You could be seriously burned.

**!** Do not ignore the low engine coolant level warning. Extended driving with the message and symbol displayed may cause serious engine damage not covered by the Mercedes-Benz Limited Warranty.

Do not drive without sufficient amount of coolant in the cooling system. The engine will overheat causing major engine damage.



## Vehicle status messages in the multifunction display

Display messages	Possible cause/consequence	Possible solution
 <p data-bbox="312 199 552 284">Coolant Stop Vehicle, turn engine off.</p>	<p data-bbox="568 199 804 221">The coolant is too hot.</p>	<ul style="list-style-type: none"> <li data-bbox="1015 199 1497 250">▶ Stop the vehicle immediately as soon as it is safe to do so.</li> <li data-bbox="1015 262 1369 284">▶ Turn off the engine immediately.</li> <li data-bbox="1015 295 1305 318">▶ Engage the parking brake.</li> <li data-bbox="1015 329 1506 412">▶ Only start the engine again after the message disappears. You could otherwise damage the engine.</li> <li data-bbox="1015 423 1506 474">▶ Observe the coolant temperature indicator in the instrument cluster.</li> <li data-bbox="1015 486 1465 568">▶ If the temperature rises again: Contact an authorized Mercedes-Benz Center immediately.</li> </ul> <p data-bbox="1015 580 1506 665">During severe operation conditions and stop-and-go city traffic, the coolant temperature may rise close to 248°F (120°C).</p>

 **Warning!**

Driving when your engine is overheated can cause some fluids which may have leaked into the engine compartment to catch fire. You could be seriously burned.



Steam from an overheated engine can cause serious burns which can occur just by opening the engine hood. Stay away from the engine if you see or hear steam coming from it.

Stop the vehicle in a safe location away from other traffic. Turn off the engine, get out of the vehicle and do not stand near the vehicle until the engine has cooled down.



### Vehicle status messages in the multifunction display

- ❗ The engine should not be operated with the coolant temperature above 248°F (120°C). Doing so may cause serious damage which is not covered by the Mercedes-Benz Limited Warranty.

## Vehicle status messages in the multifunction display

Display messages	Possible cause/consequence	Possible solution
 <p data-bbox="312 199 552 284">Coolant Stop Vehicle, turn engine off.</p>	<p data-bbox="568 199 906 221">The poly-V-belt could be broken.</p>	<ul style="list-style-type: none"> <li data-bbox="1010 199 1497 250">▶ Stop the vehicle immediately as soon as it is safe to do so.</li> <li data-bbox="1010 262 1369 284">▶ Turn off the engine immediately.</li> <li data-bbox="1010 295 1265 318">▶ Check the poly-V-belt.</li> <li data-bbox="1010 329 1501 474">▶ <b>If it is broken:</b> Do not continue to drive. Otherwise the engine will overheat due to an inoperative water pump which may result in damage to the engine. Contact an authorized Mercedes-Benz Center.</li> <li data-bbox="1010 486 1509 631">▶ <b>If it is intact:</b> Do not continue to drive the vehicle with this message displayed. Doing so could result in serious engine damage that is not covered by the Mercedes-Benz Limited Warranty.</li> <li data-bbox="1010 642 1501 687">▶ Observe the coolant temperature indicator in the instrument cluster.</li> <li data-bbox="1010 698 1509 754">▶ Drive to the nearest authorized Mercedes-Benz Center immediately.</li> </ul>
	<p data-bbox="568 785 911 836">The cooling fan for the coolant is malfunctioning.</p>	<ul style="list-style-type: none"> <li data-bbox="1010 785 1501 836">▶ Observe the coolant temperature indicator in the instrument cluster.</li> </ul>

## Vehicle status messages in the multifunction display

Display messages	Possible cause/consequence	Possible solution
		<p>If the coolant temperature is below 248°F (120°C), you may continue driving to an authorized Mercedes-Benz Center.</p> <ul style="list-style-type: none"> <li>▶ Avoid placing heavy loads on the engine (e.g. by driving uphill) as well as stop-and-go traffic.</li> <li>▶ Have the fan replaced as soon as possible.</li> </ul>
	<p>The battery is no longer charging.</p> <p>Possible causes:</p> <ul style="list-style-type: none"> <li>• alternator malfunctioning</li> <li>• broken poly-V-belt</li> <li>• a malfunction in the electronic system</li> </ul>	<ul style="list-style-type: none"> <li>▶ Stop immediately in a safe location or as soon as it is safe to do so and check the poly-V-belt.</li> <li>▶ <b>If it is broken:</b> Do not continue to drive. Otherwise the engine will overheat due to an inoperative water pump which may result in damage to the engine. Contact an authorized Mercedes-Benz Center.</li> <li>▶ <b>If it is intact:</b> Drive to the nearest authorized Mercedes-Benz Center immediately. Adjust driving to be consistent with reduced braking responsiveness.</li> </ul>
	<p>Low Voltage Start Engine</p>	<p>The battery has insufficient voltage.</p> <ul style="list-style-type: none"> <li>▶ Start the engine.</li> </ul>
	<p>Check oil level at next refueling.</p>	<p>The engine oil has dropped to a critical level.</p> <ul style="list-style-type: none"> <li>▶ Check the engine oil level (▷ page 243) and add engine oil as required (▷ page 244).</li> <li>▶ If you must add engine oil frequently, have the engine checked for possible leaks.</li> </ul>

### Vehicle status messages in the multifunction display





If the message **Check oil level at next refueling** appears while the engine is running and at operating temperature, the engine oil level has dropped to approximately the minimum level.

The message will be stored in the vehicle status message memory after you have cleared it from the multifunction display.

Visually check for oil leaks. If there are no obvious oil leaks, drive to the nearest service station to refill your engine oil to the required level.

For information on approved engine oils contact an authorized Mercedes-Benz Center or visit **www.mbusa.com** (USA only).

**!** Engine oil level warnings should not be ignored. Extended driving with the symbol displayed could result in serious engine damage that is not covered by the Mercedes-Benz Limited Warranty.





Display messages	Possible cause/consequence	Possible solution
	The fuel level is low.	▶ Refuel at the next gas station.
 Reserve Fuel	The fuel level has dropped below the reserve mark.	▶ Refuel at the next gas station.
 Ultra Low-sulfur Diesel Fuel Only	Vehicles with diesel engine only: The fuel level has dropped below the reserve mark.	▶ Refuel at the next gas station. ▶ Only use commercially available vehicular ULTRA-LOW SULFUR DIESEL FUEL (15 ppm SULFUR MAXIMUM).
 Gas Cap Is Open	A loss of pressure has been detected in the fuel system. The fuel cap may not be closed properly or the fuel system may be leaky.	▶ Check the fuel cap (▶ page 239). ▶ <b>If it is not closed properly:</b> Close the fuel cap. ▶ <b>If it is closed properly:</b> Have the fuel system checked at an authorized Mercedes-Benz Center.
 Replace Air Filter	The air filter is clogged.	▶ Have the air filter checked at an authorized Mercedes-Benz Center.







### Vehicle status messages in the multifunction display

Display messages	Possible cause/consequence	Possible solution
 Clean Fuel Filter	There is water in the fuel filter.	▶ Have the water drained at an authorized Mercedes-Benz Center as soon as possible.





### Lamps

Display messages	Possible cause/consequence	Possible solution
 Active Headlamps Inoperative	The active Bi-Xenon headlamp system is malfunctioning.	▶ Contact an authorized Mercedes-Benz Center as soon as possible.
 Active Headlamps Auxiliary Bulb On	The active Bi-Xenon headlamps are malfunctioning. Another light is being used.	▶ Contact an authorized Mercedes-Benz Center as soon as possible.
 Reverse Lamp Left or Reverse Lamp Right	The left or right backup lamp is malfunctioning.	▶ Contact an authorized Mercedes-Benz Center as soon as possible.
 Brake-/Tail Lamp Left Auxiliary Bulb On or Brake-/Tail Lamp Right Auxiliary Bulb On	The left or right brake/tail lamp is malfunctioning. This message will only appear if all LEDs have stopped working.	▶ Contact an authorized Mercedes-Benz Center as soon as possible.
 3rd Brake Lamp	The high-mounted brake lamp is malfunctioning. This message will only appear if all LEDs have stopped working.	▶ Contact an authorized Mercedes-Benz Center as soon as possible.

## Vehicle status messages in the multifunction display





Display messages		Possible cause/consequence	Possible solution
	Front Foglamp Left or Front Foglamp Right	The left or right front fog lamp is malfunctioning.	▶ Contact an authorized Mercedes-Benz Center as soon as possible.
	Marker Lamp Front Left or Marker Lamp Front Right	The front left side or right side marker lamp is malfunctioning.	▶ Contact an authorized Mercedes-Benz Center as soon as possible.
	Parking Lamp Front Left Auxiliary Bulb On or Parking Lamp Front Right Auxiliary Bulb On	The left or right front parking lamp is malfunctioning. A substitute bulb is being used.	▶ Contact an authorized Mercedes-Benz Center as soon as possible.
	High Beam Left or High Beam Right	The left or right high-beam lamp is malfunctioning.	▶ Replace the bulb as soon as possible (▷ page 348).
	License Plate Lamp Left or License Plate Lamp Right	The left or right license plate lamp is malfunctioning.	▶ Replace the bulb as soon as possible (▷ page 348).

## Vehicle status messages in the multifunction display

Display messages	Possible cause/consequence	Possible solution
 AUTO-Light Inoperative	The light sensor is malfunctioning. The headlamps come on automatically.	<ul style="list-style-type: none"> <li>▶ Contact an authorized Mercedes-Benz Center as soon as possible.</li> </ul> To switch off the headlamps (U.S. vehicles only): <ul style="list-style-type: none"> <li>▶ In the control system, set daytime running lamp mode to manual (▷ page 153).</li> <li>▶ Switch off the headlamps using the exterior lamp switch (▷ page 111).</li> </ul>
 Low Beam Left or Low Beam Right	The left or right low-beam lamp is malfunctioning.	<ul style="list-style-type: none"> <li>▶ <b>Halogen headlamp:</b> Replace the bulb as soon as possible (▷ page 348).</li> <li>▶ <b>Bi-Xenon headlamp:</b> Contact an authorized Mercedes-Benz Center as soon as possible.</li> </ul>
 Rear Left Foglamp	The rear fog lamp is malfunctioning.	<ul style="list-style-type: none"> <li>▶ Contact an authorized Mercedes-Benz Center as soon as possible.</li> </ul>
 Switch Off Lights	You have removed the SmartKey from the starter switch, opened the driver's door and left the headlamps on or removed the SmartKey with KEYLESS-GO from the vehicle and left the headlamps on.	<ul style="list-style-type: none"> <li>▶ Turn the exterior lamp switch to <b>0</b> or <b>AUTO</b> (▷ page 111).</li> </ul> or <ul style="list-style-type: none"> <li>▶ <b>With the rear fog lamp switched on:</b> Push in the exterior lamp switch to its stop.</li> </ul>
 Tail Lamp Left Auxiliary Bulb On or Tail Lamp Right Auxiliary Bulb On	The left or right tail lamp is malfunctioning. A substitute bulb is being used.	<ul style="list-style-type: none"> <li>▶ Contact an authorized Mercedes-Benz Center as soon as possible.</li> </ul>





## Vehicle status messages in the multifunction display

Display messages		Possible cause/consequence	Possible solution
	Cornering Lamp Left or Cornering Lamp Right	The left or right corner-illuminating front fog lamp is malfunctioning.	► Contact an authorized Mercedes-Benz Center as soon as possible.
	Rear Left Turn Signal or Rear Right Turn Signal	The left or right rear turn signal lamp is malfunctioning.	► Contact an authorized Mercedes-Benz Center as soon as possible.
	Front Left Turn Signal or Front Right Turn Signal	The left or right front turn signal lamp is malfunctioning.	► Replace the bulb as soon as possible (▷ page 348).
	Left Mirror Turn Signal or Right Mirror Turn Signal	The turn signal in the left or right exterior rear view mirror is malfunctioning. This message will only appear if all LEDs have stopped working.	► Contact an authorized Mercedes-Benz Center as soon as possible.

### Vehicle status messages in the multifunction display

#### Tires

Display messages	Possible cause/consequence	Possible solution
 <p>Please correct the tire pressure.</p>	<p>The tire pressure is too low in one or more tires.</p> <p>or</p> <p>The tire pressure of the individual tires differ from each other significantly.</p>	<p>▶ Check and correct tire inflation pressure as required (▷ page 255).</p>
 <p>Tire Pressure Caution Tire Defect</p>	<p>One or more tires are deflating.</p>	<p>▶ Carefully bring the vehicle to a halt, avoiding abrupt steering and braking maneuvers.</p> <p>▶ If necessary, change the wheel (▷ page 355).</p>
 <p>Tire Pressure Check Tires</p>	<p>The tire pressure in one or more tires is already below the minimum value.</p>	<p>▶ Carefully bring the vehicle to a halt, avoiding abrupt steering and braking maneuvers.</p> <p>▶ Check and adjust tire pressure as required.</p> <p>▶ If necessary, change the wheel (▷ page 355).</p>

#### **Warning!**

Do not drive with a flat tire. A flat tire affects the ability to steer or brake the vehicle. You may lose control of the vehicle. Continued driving with a flat tire will cause excessive heat build-up and possibly a fire.

#### **Warning!**

Follow recommended tire inflation pressures.

Do not underinflate tires. Underinflated tires wear excessively and/or unevenly, adversely affect handling and fuel economy, and are more likely to fail from being overheated.

Do not overinflate tires. Overinflated tires can adversely affect handling and ride comfort, wear unevenly, increase stopping distance, and result in sudden deflation (blowout) because they are more likely to become punctured or damaged by road debris, potholes etc.

**Vehicle status messages in the multifunction display**

### What to do if ...

#### What to do if ...

#### Lamps in instrument cluster

#### Notes





---

If any of the following lamps in the instrument cluster fails to come on during the bulb self-

check when switching on the ignition, have the respective bulb checked and replaced if necessary.

When you switch on the ignition, all lamps (except low-beam headlamp indicator lamp, high-beam headlamp indicator lamp, and turn signal indicator lamps unless activated) in the instrument cluster come on. If a lamp in the instrument cluster fails to come on when the ignition is switched on, have it checked and replaced if necessary.

Brake

Problem	Possible cause/consequence	Suggested solutions
<p> The yellow ABS indicator lamp comes on while the engine is running.</p>	<p>The ABS has detected a malfunction and switched off. The BAS, ESP®, EBP and PRE-SAFE® are also switched off (see messages in multifunction display).</p> <p>The brake system is still functioning normally but without the systems specified above available.</p> <p>If the ABS control unit is malfunctioning, other systems such as the navigation system or the automatic transmission may also be malfunctioning.</p>	<ul style="list-style-type: none"> <li>▶ Continue driving with added caution. Wheels may lock during hard braking, reducing steering capability.</li> <li>▶ Read and observe messages that may appear in the multifunction display (▷ page 295).</li> <li>▶ Have the system checked at an authorized Mercedes-Benz Center as soon as possible.</li> </ul> <p>Failure to follow these instructions increases the risk of an accident.</p>
<p> The yellow ABS indicator lamp comes on while the engine is running.</p>	<p>The ABS has switched off due to insufficient power supply. The battery might not be charged sufficiently.</p>	<p>When the voltage is above the required value again, the ABS is operational again and the ABS indicator lamp should go out.</p> <ul style="list-style-type: none"> <li>▶ If the ABS indicator lamp does not go out: Have the alternator and the battery checked.</li> </ul>
<p> (USA only)   (Canada only)</p> <p>The red brake warning lamp comes on while driving and an acoustic warning sounds.</p>	<p>You are driving with the parking brake engaged.</p>	<ul style="list-style-type: none"> <li>▶ Release the parking brake.</li> </ul>



### What to do if ...

Problem	Possible cause/consequence	Suggested solutions
<p><b>BRAKE</b> (USA only)   (Canada only)</p> <p>The red brake warning lamp comes on while the engine is running and an acoustic warning sounds.</p>	<p>There is insufficient brake fluid in the reservoir.</p>	<ul style="list-style-type: none"> <li>▶ Risk of accident! Do not drive any further. Stop the vehicle in a safe location as soon as it is safe to do so.</li> <li>▶ Engage the parking brake.</li> <li>▶ Read and observe messages that may appear in the multifunction display (▷ page 295).</li> <li>▶ Contact an authorized Mercedes-Benz Center. Do not add brake fluid! This will not solve the problem.</li> </ul>



### **Warning!**

Driving with the brake warning lamp illuminated can result in an accident. Have your brake system checked immediately if the brake warning lamp stays on. Do not add brake fluid before checking the brake system.

Overfilling the brake fluid reservoir can result in spilling brake fluid on hot engine parts and the brake fluid catching fire. You can be seriously burned.

- !** If you find that the brake fluid in the brake fluid reservoir has fallen to the minimum mark or below, have the brake system checked for brake pad thickness and leaks.

## Safety systems

Problem	Possible cause/consequence	Suggested solutions
 The red seat belt telltale comes on for a maximum of 6 seconds after starting the engine.	The seat belt telltale reminds you and your passengers to fasten your seat belts before driving off.	<ul style="list-style-type: none"> <li>▶ Fasten your seat belts.</li> </ul> Regardless of whether the seat belts are fastened or not, the seat belt telltale always comes on and remains lit for 6 seconds after starting the engine.
 You hear a warning chime for a maximum of 6 seconds after starting the engine.	You have forgotten to fasten your seat belt.	<ul style="list-style-type: none"> <li>▶ Fasten your seat belt.</li> </ul> The warning chime stops sounding.
 The red seat belt telltale comes on while the vehicle is standing still and the engine is running or during driving.	You and/or your front passenger have forgotten to fasten your seat belts.	<ul style="list-style-type: none"> <li>▶ Fasten your seat belts.</li> </ul> The seat belt telltale goes out.
	There are items placed on the front passenger seat and therefore the system senses the front passenger seat as being occupied.	<ul style="list-style-type: none"> <li>▶ Remove the items from the front passenger seat and put them in a safe place.</li> </ul> The seat belt telltale goes out.

### What to do if ...

Problem	Possible cause/consequence	Suggested solutions
 During driving the red seat belt telltale flashes and you additionally hear an intermittent warning chime with increasing intensity.	The vehicle's speed once exceeded 15 mph (25 km/h) and you and/or your front passenger have forgotten to fasten your seat belts.	<ul style="list-style-type: none"> <li>▶ Fasten your seat belts. The seat belt telltale goes out and the warning chime stops sounding.</li> </ul>
	There are items placed on the front passenger seat and therefore the system senses the front passenger seat as being occupied.	<ul style="list-style-type: none"> <li>▶ Remove the items from the front passenger seat and put them in a safe place. The seat belt telltale goes out and the warning chime stops sounding.</li> </ul>

 After 60 seconds with an unfastened seat belt the warning chime stops sounding and the seat belt telltale illuminates continuously. The seat belt telltale will only go out if both, the driver and front passenger's seat belt are fastened, or the vehicle is standing still and a front door is opened.



Problem	Possible cause/consequence	Suggested solutions
 The red SRS indicator lamp comes on while driving.	There is a malfunction in the restraint systems. The air bags or Emergency Tensioning Devices (ETDs) could deploy unexpectedly or fail to activate in an accident.	<ul style="list-style-type: none"> <li>▶ Drive with added caution to the nearest authorized Mercedes-Benz Center.</li> </ul>

### **Warning!**

In the event a malfunction of the SRS is indicated as outlined above, the SRS may not be operational.





For your safety, we strongly recommend that you contact an authorized Mercedes-Benz Center immediately to have the system checked. Otherwise the SRS may not be activated when needed in an accident, which could result in serious or fatal injury, or it might deploy unexpectedly and unnecessarily which could also result in injury.

Problem	Possible cause/consequence	Suggested solutions
 The yellow ESP® warning lamp comes on while the engine is running.	<p>The ESP® has been switched off. Risk of accident!</p> <p>When the ESP® is switched off it will not stabilize the vehicle if the system recognizes that the vehicle starts to skid or that a wheel is spinning.</p>	<ul style="list-style-type: none"> <li>▶ Switch the ESP® back on. Exceptions: (▷ page 74).</li> <li>▶ If leaving the ESP® switched off, adapt your speed and driving to the prevailing road and weather conditions.</li> <li>▶ If the ESP® cannot be switched back on: Have the system checked at an authorized Mercedes-Benz Center as soon as possible.</li> </ul>
 The yellow ESP® warning lamp comes on while the engine is running.	<p>The ESP® is not operational due to a malfunction. Risk of accident!</p>	<ul style="list-style-type: none"> <li>▶ Read and observe additional messages that may appear in the multifunction display.</li> <li>▶ Continue driving with added caution.</li> <li>▶ Adapt your speed and driving to the prevailing road and weather conditions.</li> <li>▶ Have the system checked at an authorized Mercedes-Benz Center as soon as possible.</li> </ul>

### What to do if ...

Problem	Possible cause/consequence	Suggested solutions
 The yellow ESP® warning lamp flashes while driving.	<p>The ESP® or Electronic Traction System (ETS/4-ETS) has come into operation because of detected traction loss in at least one tire.</p> <p>The cruise control and the Distronic system are deactivated.</p>	<ul style="list-style-type: none"> <li>▶ When driving off, apply as little throttle as possible.</li> <li>▶ While driving, ease up on the accelerator pedal.</li> <li>▶ Adapt your speed and driving to the prevailing road and weather conditions.</li> <li>▶ Do not deactivate the ESP®.</li> </ul> <p>Exceptions: (▷ page 74).</p> <p>Failure to follow these instructions increases the risk of an accident.</p>

### Driving systems





Problem	Possible cause/consequence	Suggested solutions
 The red distance warning lamp comes on while driving.	<p>You are too close to the vehicle in front of you to maintain selected speed.</p>	<ul style="list-style-type: none"> <li>▶ Apply the brakes immediately to increase the following distance.</li> </ul>
 The red distance warning lamp comes on while driving and an acoustic warning sounds.	<p>You are gaining too rapidly on the vehicle ahead of you or the distance warning system has recognized a stationary obstacle on your probable line of travel.</p>	<ul style="list-style-type: none"> <li>▶ Apply the brakes immediately.</li> <li>▶ Carefully observe the traffic situation. You may need to brake or maneuver to avoid hitting an obstacle.</li> </ul>



## Vehicle

Problem	Possible cause/consequence	Suggested solutions
 The yellow fuel tank reserve warning lamp comes on when the engine is running.	The fuel level has gone below the reserve mark.	▶ Refuel at the next gas station.

## What to do if ...

### Engine

Problem	Possible cause/consequence	Suggested solutions
<p> (USA only)   (Canada only)</p> <p>The yellow engine malfunction indicator lamp comes on when the engine is running.</p>	<p>There may be a malfunction in:</p> <ul style="list-style-type: none"> <li>• The fuel management system</li> <li>• The ignition system</li> <li>• The emission control system</li> <li>• Systems which affect emissions</li> </ul> <p>Such malfunctions may result in excessive emissions values and may switch the engine to limp-home (emergency operation) mode.</p>	<ul style="list-style-type: none"> <li>▶ Have the vehicle checked as soon as possible at an authorized Mercedes-Benz Center.</li> <li><b>i</b> Some states may by law require you to visit a workshop as soon as the engine malfunction indicator lamp comes on. Check local requirements.</li> </ul>
<p> (USA only)   (Canada only)</p> <p>The yellow engine malfunction indicator lamp comes on when the engine is running.</p>	<p>A loss of pressure has been detected in the fuel system. The fuel cap may not be closed properly or the fuel system may be leaky.</p> <p>Diesel engine: Your fuel tank was driven empty.</p>	<ul style="list-style-type: none"> <li>▶ Check the fuel cap (▷ page 239).</li> <li>▶ <b>If it is not closed properly:</b> Close the fuel cap.</li> <li>▶ <b>If it is closed properly:</b> Have the fuel system checked by an authorized Mercedes-Benz Center.</li> <li>▶ After refueling, start, turn off and restart the engine three or four times in succession. The limp-home mode is canceled. You do not need to have your vehicle checked.</li> </ul>

Problem	Possible cause/consequence	Suggested solutions
 The red coolant temperature warning lamp comes on when the engine is running.	<p>There is insufficient coolant in the reservoir.</p> <p>If this warning lamp comes on frequently, there is a leak in the cooling system.</p> <p>If the coolant level is correct, the electric radiator fan may be broken.</p>	<ul style="list-style-type: none"> <li>▶ Immediately add coolant to prevent engine from overheating (▷ page 245).</li> <li>▶ Have the cooling system checked.</li> <li>▶ If the coolant temperature is below 248°F (120°C), you can continue driving to the nearest authorized Mercedes-Benz Center.</li> <li>▶ Avoid high engine loads (e.g. driving uphill) and stop-and-go driving.</li> </ul>
 The red coolant temperature warning lamp comes on when the engine is running and an acoustic warning sounds.	<p>The coolant temperature has exceeded 248°F (120°C).</p>	<ul style="list-style-type: none"> <li>▶ Stop in a safe location as soon as possible and allow the engine and coolant to cool down.</li> </ul>

 **Warning!**



Driving when your engine is overheated can cause some fluids which may have leaked into the engine compartment to catch fire. You could be seriously burned.

Steam from an overheated engine can cause serious burns which can occur just by opening the engine hood. Stay away from the engine if you see or hear steam coming from it.

Stop the vehicle in a safe location away from other traffic. Turn off the engine, get out of the vehicle and do not stand near the vehicle until the engine has cooled down.

## What to do if ...

### Tires

Problem	Possible cause/consequence	Suggested solutions
 USA only: Combination low tire pressure telltale/TPMS malfunction telltale for the TPMS illuminates continuously. Canada only: Low tire pressure telltale for the Advanced TPMS illuminates continuously.	The TPMS (USA only) or Advanced TPMS (Canada only) detects a loss of pressure in at least one tire.	<ul style="list-style-type: none"> <li>▶ Carefully bring the vehicle to a halt, avoiding abrupt steering and braking maneuvers. Observe the traffic situation around you.</li> <li>▶ Read and observe messages in the multifunction display (▷ page 295).</li> </ul> <p>If the tire inflation pressure in the respective tire(s) has (have) been corrected, the combination low tire pressure/TPMS malfunction telltale goes out after a few minutes of driving.</p>
 USA only: Combination low tire pressure telltale/TPMS malfunction telltale for the TPMS flashes 60 seconds and then stays illuminated.	There is a malfunction in the TPMS.	<ul style="list-style-type: none"> <li>▶ Read and observe messages in the multifunction display (▷ page 295).</li> <li>▶ Have the TPMS checked by an authorized Mercedes-Benz Center.</li> </ul> <p>After the malfunction has been remedied, the combination low tire pressure/TPMS malfunction telltale goes out after a few minutes of driving.</p>

### **Warning!**

Each tire, including the spare (if provided), should be checked every other week when cold and inflated to the inflation pressure recommended by the vehicle manufacturer on the Tire and Loading Information placard

on the driver's door B-pillar or, if available, the tire inflation pressure label on the inside of the fuel filler flap. If your vehicle has tires of a different size than the size indicated on the vehicle placard or the tire inflation

pressure label, you should determine the proper tire inflation pressure for those tires. As an added safety feature, your vehicle has been equipped with a tire pressure monitoring system (TPMS) that illuminates a low tire pressure telltale when one or

What to do if ...

more of your tires are significantly underinflated. Accordingly, when the low tire pressure telltale illuminates, you should stop and check your tires as soon as possible, and inflate them to the proper pressure. Driving on a significantly underinflated tire causes the tire to overheat and can lead to tire failure. Underinflation also reduces fuel efficiency and tire tread life, and may affect the vehicle's handling and stopping ability. Please note that the TPMS is not a substitute for proper tire maintenance, and it is the driver's responsibility to maintain correct tire pressure, even if underinflation

has not reached the level to trigger illumination of the TPMS low tire pressure telltale.  
 USA only:  
 Your vehicle has also been equipped with a TPMS malfunction indicator to indicate when the system is not operating properly. The TPMS malfunction indicator is combined with the low tire pressure telltale. When the system detects a malfunction, the telltale will flash for approximately 1 minute and then remain continuously illuminated. This sequence will continue upon subsequent vehicle



start-ups as long as the malfunction exists. When the malfunction indicator is illuminated, the system may not be able to detect or signal low tire pressure as intended.  
 TPMS malfunctions may occur for a variety of reasons, including the installation of replacement or alternate tires or wheels on the vehicle that prevent the TPMS from functioning properly. Always check the TPMS malfunction telltale after replacing one or more tires or wheels on your vehicle to ensure that the replacement or alternate tires and wheels allow the TPMS to continue to function properly.

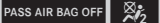

Lamp in center console

Problem	Possible cause/consequence	Suggested solutions
<p> The front passenger front air bag off indicator lamp illuminates and remains illuminated with the weight of a typical adult or someone larger than a small individual on the front passenger seat.</p>	<p>The system is malfunctioning.</p>	<ul style="list-style-type: none"> <li>▶ Have the system checked as soon as possible at an authorized Mercedes-Benz Center.</li> <li>▶ Read and observe messages in the multifunction display and follow corrective steps (▶ page 295).</li> </ul>



## What to do if ...

### **Warning!**

If the   indicator lamp illuminates and remains illuminated with the weight of a typical adult or someone larger than a small individual on the front passenger seat, do not have any passenger use the front passenger seat until the system has been repaired.

Problem	Possible cause/consequence	Suggested solutions
  The front passenger front air bag off indicator lamp does not illuminate and/or does not remain illuminated with the weight of a typical 12-month-old child in a standard child restraint or less on the front passenger seat.	The system is malfunctioning.	<ul style="list-style-type: none"> <li>▶ Make sure there is nothing between seat cushion and child seat and check installation of the child seat.</li> <li>▶ Make sure no objects applying supplemental weight onto the seat are present.</li> <li>▶ Make sure no objects which apply forces to the seat are present (e.g. objects such as books, briefcases etc. lodged behind or around the seat, head restraints pushing against roof etc.). The system may recognize such forces as supplemental weight.</li> <li>▶ If the front passenger front air bag off indicator lamp remains out, have the system checked as soon as possible at an authorized Mercedes-Benz Center. Do not transport a child on the front passenger seat until the system has been repaired.</li> <li>▶ Read and observe messages in the multifunction display and follow corrective steps (▷ page 295).</li> </ul>

### **Warning!**

If the   indicator lamp does not illuminate or remains out with the weight of a typical 12-month-old child in a standard child restraint or less on the front passenger seat, do not transport a child on the front passenger seat until the system has been repaired.



## Unlocking/locking manually

### Unlocking the vehicle

If you cannot unlock the vehicle with the SmartKey or with KEYLESS-GO, unlock the driver's door and the trunk (sedan only) using the mechanical key.

- i** Unlocking the vehicle with the mechanical key and opening the driver's door or the trunk (sedan only) will trigger the anti-theft alarm system.

To cancel the alarm, insert the SmartKey in the starter switch.

### Removing the mechanical key

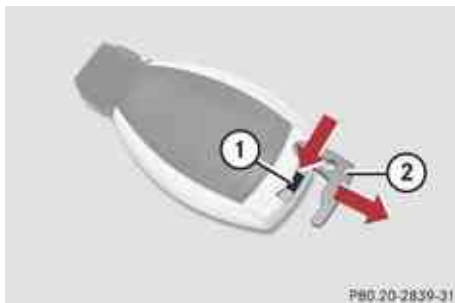

- ① Mechanical key locking tab
- ② Mechanical key

- ▶ Move locking tab ① in direction of arrow.
- ▶ Slide mechanical key ② out of the housing.

### Unlocking the driver's door



- ① Unlocking
- ② Mechanical key

- ▶ Insert mechanical key ② into the driver's door lock until it stops.
- ▶ Turn mechanical key ② counterclockwise to position ① until the locking knob moves up. The driver's door is unlocked.
- ▶ Pull the door handle to open the driver's door.
- ▶ Turn mechanical key ② back and remove it from the driver's door lock.

## Unlocking/locking manually

### Unlocking the trunk (sedan)

A minimum height clearance of 5.90 ft (1.80 m) is required to open the trunk lid.



- ① Mechanical key
- ② Unlocking
- ③ Handle

- ▶ Insert mechanical key ① into the trunk lid lock until it stops.
- ▶ Turn mechanical key ① counterclockwise to position ②.
- ▶ Pull trunk lid handle ③ and lift lid.

- !** Always make sure there is sufficient overhead clearance.

### Unlocking/locking manually

- ▶ Turn mechanical key ① back and remove it from the trunk lid lock.

### Unlocking the tailgate (wagon)

- ① This feature is available on the E 63 AMG unless the vehicle is equipped with foldable third-row seats.

A minimum height clearance of 6.81 ft (2.07 m) is required to open the tailgate.

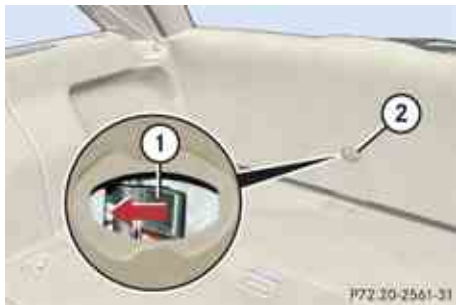

- ① Emergency release lever
- ② Cover

- ▶ Remove cover ② from the trim on the tailgate.
- ▶ Push emergency release lever ① in direction of arrow.
- ▶ Lift the tailgate.

- ❗ Always make sure there is sufficient overhead clearance.

- ① If the vehicle has previously been locked using the SmartKey or with KEYLESS-GO, opening the tailgate from the inside will trigger the anti-theft alarm system. To cancel the alarm, insert the SmartKey in the starter switch.

### Locking the vehicle

If you cannot lock the vehicle with the SmartKey or with KEYLESS-GO, lock it as follows:

- ▶ Close the front passenger door, the rear doors, and the trunk/tailgate.
- ▶ Open the driver's door.
- ▶ Press the central locking switch (▷ page 85). The locking knobs of the front passenger door and the rear doors move down.
- ▶ **If the vehicle battery is disconnected or drained:** Press down the locking knobs of the front passenger door and the rear doors manually.
- ▶ Exit the vehicle.
- ▶ **Sedan only:** Check whether the trunk is locked.

- ▶ **Sedan only:** If it is not locked, lock it with the mechanical key (▷ page 93). Except for the driver's door, the vehicle should now be locked.
- ▶ Close the driver's door.



- ① Locking
- ② Mechanical key

- ▶ Remove mechanical key ② from the SmartKey (▷ page 343).
- ▶ Insert mechanical key ② into the driver's door lock until it stops.
- ▶ Turn mechanical key ② clockwise to position ①. The driver's door is locked.
- ▶ Turn mechanical key ② back and remove it from the driver's door lock.

- ⓘ This procedure does not arm the anti-theft alarm system, nor does it lock the fuel filler flap.

### Manually unlocking the gear selector lever

If the vehicle's electrical system is malfunctioning, the gear selector lever could remain locked in park position **P**. In this case the gear selector lever can be unlocked manually, e.g. to tow the vehicle.

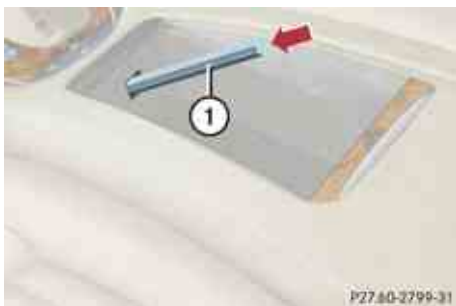

① Tool

- ▶ Engage the parking brake.
- ▶ Open the storage compartment in the center armrest (▷ page 219).
- ▶ Remove the cup holder (▷ page 220).

- ▶ Insert suitable tool ① (e.g. a screwdriver) into the opening.
- ▶ Simultaneously push tool ① downward and move the gear selector lever out of park position **P**.
- ▶ Remove tool ①.  
The gear selector lever is unlocked

- ⓘ The gear selector lever is locked again as soon as you move it back to park position **P**.

## Resetting activated head restraints

### Resetting activated head restraints

If the active head restraints have been triggered in a rear-end collision, the active head restraints must be reset.

You can tell that the active head restraints have been triggered when they have been moved forward and cannot be adjusted.

#### ⚠ Warning!

For safety reasons, have the active head restraints checked at an authorized Mercedes-Benz Center after a rear-end collision.

#### ⚠ Warning!

When pushing back the head restraint cushion, make sure your fingers do not become caught between the head restraint cushion and the cover. Failing to do so may lead to injury.

- ⚠ Be careful not to damage upholstery.

- ⓘ For your convenience, we recommend that you have this work carried out at an authorized Mercedes-Benz Center.

### Replacing SmartKey batteries



① Reset tool

② Active head restraint cushion

③ Rectangular opening

- ▶ Take reset tool ① out of the Mercedes-Benz literature pouch.
- ▶ Guide reset tool ① into rectangular opening ③ between active head restraint cushion ② and head restraint cover.
- ▶ Press reset tool ① downward in direction of arrow until you hear the head restraint release mechanism audibly engage.
- ▶ Pull out reset tool ①.
- ▶ Firmly press the active head restraint cushion ② backward towards the head restraint cover in direction of arrow until it engages.

▶ Repeat this procedure for the second front seat.

▶ After resetting the active head restraints store reset tool ① in the Mercedes-Benz literature pouch.

For information on active head restraints, see “Active head restraints” (▶ page 60).

For information on head restraint adjustment, see “Seats” (▶ page 95).

### Replacing SmartKey batteries

If the batteries in the SmartKey are discharged, the vehicle can no longer be locked or unlocked. It is recommended to have the batteries replaced at an authorized Mercedes-Benz Center.

#### **⚠ Warning!**

Batteries contain poisonous and corrosive substances. Therefore, keep the batteries out of reach of children.

If a battery is swallowed, seek medical help immediately.

#### **⚠ Warning!**

SmartKey batteries contain perchlorate material, which may require special handling and regard for the environment. Check with your local government’s disposal guidelines. California residents, see [www.dtsc.ca.gov/HazardousWaste/Perchlorate/index.cfm](http://www.dtsc.ca.gov/HazardousWaste/Perchlorate/index.cfm).

Batteries contain materials that can harm the environment if disposed of improperly. Recycling of batteries is the preferred method of disposal. Many states/provinces require

## Replacing SmartKey batteries

sellers of batteries to accept old batteries for recycling.

When inserting the batteries, make sure they are clean and free of lint.

When replacing batteries, always replace both batteries.

**i** The required replacement batteries are available at any authorized Mercedes-Benz Center.

Replacement batteries: Lithium, type CR 2025 or equivalent.

▶ Remove the mechanical key from the SmartKey (> page 343).

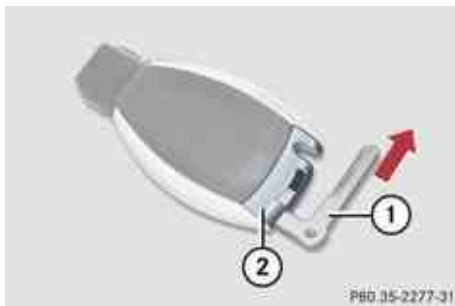

- ① Mechanical key
- ② Battery compartment

- ▶ Insert mechanical key ① into opening.
- ▶ Press mechanical key ① in direction of arrow.  
Battery compartment ② is unlatched.
- ▶ Pull battery compartment ② out of the SmartKey housing.

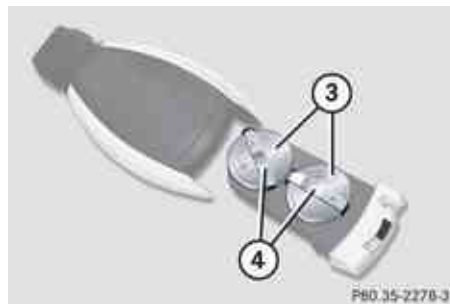

- ③ Batteries
  - ④ Contact springs
- ▶ Pull out batteries ③.
  - ▶ Insert new batteries ③ under contact springs ④ with the positive terminal (+) side facing up.
  - ▶ Return battery compartment ② into SmartKey housing until it locks into place.

- ▶ Slide mechanical key ① back into the SmartKey.
- ▶ Check the operation of the SmartKey as well as the KEYLESS-GO function.

### Replacing bulbs

#### Replacing bulbs

#### Safety notes

Safe vehicle operation depends on proper exterior lighting and signaling to a large degree.

Correct headlamp adjustment is extremely important. Have headlamps checked and readjusted at regular intervals and when a bulb has been replaced. Contact an authorized Mercedes-Benz Center for headlamp adjustment.

#### **⚠ Warning!**

Bulbs and bulb sockets can be very hot. Allow the lamp to cool down before changing a bulb.

Keep bulbs out of reach of children.

Halogen lamps contain pressurized gas. A bulb can explode if you:

- touch or move it when hot
- drop the bulb
- scratch the bulb

Wear eye and hand protection.

Because of high voltage in Xenon lamps, it is dangerous to replace the bulb or repair the lamp and its components. We

recommend that you have such work done by a qualified technician.

#### **⚠ Warning!**

The bulbs in the tail lamps cannot be replaced individually. The tail lamp bulbs are under pressure and could explode during an attempt to replace them.

If the tail lamps are malfunctioning, have them replaced at an authorized Mercedes-Benz Center.

**1** Since replacing bulbs is a technically highly demanding process, we recommend to have them replaced at an authorized Mercedes-Benz Center.

**1** If the headlamps or front fog lamps are fogged up on the inside as a result of high humidity, driving the vehicle a distance with the lights on should clear up the fogging.

#### Bulbs



Example illustration sedan

Replacing bulbs



Wagon

Front lamps

	Lamp	Type
①	Additional turn signal lamp	LED
②	Turn signal lamp	3547 A

	Lamp	Type
③	Halogen headlamp: Low beam	H7 (55 W)
	Bi-Xenon headlamp: Low and high beam <sup>20</sup>	D1S-35 W
④	Side marker lamp	W 5 W
⑤	Halogen headlamp: High beam/high-beam flasher	H7 (55 W)
	Bi-Xenon headlamp: High-beam flasher	H7 (55 W)
	Halogen headlamp: Parking and standing lamp	W 5 W Blue Vision
	Bi-Xenon headlamp: Parking and standing lamp	LED
⑥	Front fog lamp	H11 (55 W)
	Corner-illuminating front fog lamp	H11 (55 W)

Rear lamps

	Lamp	Type
⑦	High-mounted brake lamp	LED
⑧	Tail lamp	HiP
	Turn signal lamp	HiP
	Parking and standing lamp	HiP
	Backup lamp	HiP
	Rear fog lamp (driver's side only)	HiP
⑨	Brake lamp	Sedan: HiP or LED Wagon: HiP
	License plate lamps	C 5 W

Notes on bulb replacement

- Only use 12-volt bulbs of the same type and with the specified watt rating.
- Switch the lights off before changing a bulb to prevent short circuits.

<sup>20</sup> Vehicles with Bi-Xenon headlamps: Low beam and high beam use the same D1S-35 W lamp. Do not replace the Bi-Xenon bulbs yourself. Contact an authorized Mercedes-Benz Center.

### Replacing bulbs

- Always use a clean lint-free cloth when handling bulbs.
- Your hands should be dry and free of oil and grease.
- If the newly installed bulb does not come on, contact an authorized Mercedes-Benz Center.

**i** Mercedes-Benz recommends using Longlife (LL) bulbs.

Have the LEDs and bulbs for the following lamps replaced at an authorized Mercedes-Benz Center:

- Additional turn signal lamps in the exterior rear view mirrors
- Bi-Xenon lamps
- Front fog lamps
- Front side marker lamps
- Parking and standing lamps (vehicles with Bi-Xenon headlamps only)
- Rear lamps (except license plate lamps)
- High-mounted brake lamp

**!** Do not replace the LEDs yourself. You could otherwise damage the LEDs or parts

of the vehicle. Only have the LEDs replaced at an authorized Mercedes-Benz Center.

#### Replacing bulbs for front lamps

Before you start to replace a bulb for a front lamp, do the following:

- ▶ Switch off the ignition.
- ▶ Turn the exterior lamp switch to position **0**.
- ▶ Open the hood (▶ page 241).



① Housing cover for low-beam halogen or Bi-Xenon headlamp

#### **⚠ Warning!**

Do not remove the cover for the Bi-Xenon headlamp. Because of high voltage in Xenon lamps, it is dangerous to replace the

bulb or repair the lamp and its components. It is recommended to have such work done by a qualified technician.

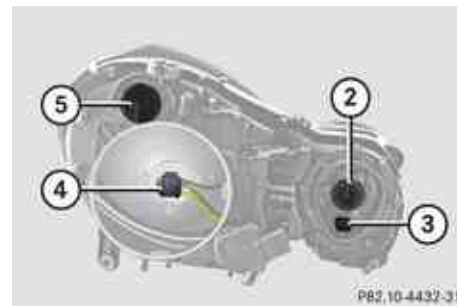

- ② Bulb socket for high-beam headlamp/ high-beam flasher bulb
- ③ Bulb socket for parking and standing lamp bulb
- ④ Bulb socket for low-beam headlamp bulb (halogen headlamps only)
- ⑤ Bulb socket for front turn signal lamp bulb

#### Low-beam bulb (halogen headlamps only)

- ▶ Turn housing cover ① counterclockwise and remove it.
- ▶ Turn bulb socket ④ with the bulb counterclockwise and remove it.



## Replacing bulbs

- ▶ Pull the bulb out of bulb socket ④.
- ▶ Gently press the new bulb into bulb socket ④.
- ▶ Place bulb socket ④ back into the housing and turn it clockwise until it engages.
- ▶ Align housing cover ① and turn it clockwise until it engages.

### High-beam and high-beam flasher bulb (halogen headlamps)/high-beam flasher bulb (Bi-Xenon headlamps)

- ▶ Turn bulb socket ② with the bulb counterclockwise and remove it.
- ▶ Pull the bulb out of bulb socket ②.
- ▶ Gently press the new bulb into bulb socket ②.
- ▶ Place bulb socket ② back into the housing and turn it clockwise until it engages.

### Front turn signal lamp bulb

- ▶ Turn bulb socket ⑤ with the bulb counterclockwise and remove it.
- ▶ Gently press onto the bulb and turn it counterclockwise out of bulb socket ⑤.

- ▶ Gently press the new bulb into bulb socket ⑤ and turn it clockwise until it engages.
- ▶ Place bulb socket ⑤ back into the housing and turn it clockwise until it engages.

### Parking and standing lamp bulb

#### Halogen headlamps

- ▶ Turn bulb socket ③ with the bulb counterclockwise and remove it.
- ▶ Pull the bulb out of bulb socket ③.
- ▶ Gently press the new bulb into bulb socket ③.
- ▶ Place bulb socket ③ back into the housing and turn it clockwise until it engages.

#### Bi-Xenon headlamps

In vehicles with Bi-Xenon headlamps, the bulbs of the parking and standing lamps are LEDs.

- ❗ Do not replace the LEDs yourself. You could otherwise damage the LEDs or parts of the vehicle. Only have the LEDs replaced at an authorized Mercedes-Benz Center.

### Replacing bulbs for rear lamps

#### Tail lamp unit

The tail lamps are equipped with HiP bulbs and LEDs. Have them replaced at an authorized Mercedes-Benz Center.

**⚠ Observe Safety notes, see page 348.**

#### License plate lamps



Example illustration: Sedan

- ① Screws
- ② Lamp cover

- ▶ Switch off the ignition.
- ▶ Turn the exterior lamp switch to position 0.
- ▶ Open the trunk.



### Replacing wiper blades

- ▶ Loosen screws ① of lamp cover to be removed.
- ▶ Remove lamp cover ②.
- ▶ Replace the bulb.
- ▶ Reinstall lamp cover ②.
- ▶ Retighten screws ①.

### Replacing wiper blades

#### Safety notes

#### ⚠ Warning!

For safety reasons, switch off wipers and remove SmartKey from starter switch (vehicles with KEYLESS-GO: Make sure the vehicle's on-board electronics have status **O**) before replacing a wiper blade. Otherwise, the wiper motor could suddenly turn on and cause injury.

#### ⚠ Warning!

Wiper blades are components that are subject to wear and tear. Replace the wiper blades twice a year, preferably in the spring and fall. Otherwise the windows will not be properly wiped. As a result, you may not be able to observe surrounding traffic conditions and could cause an accident.

❗ To avoid damage to the hood the front wiper arms should only be folded forward when in the vertical position.

❗ Never open the hood when a front wiper arm is folded forward.

Hold on to the wiper when folding a wiper arm back. If released, the force of the

impact from the tensioning spring could crack the windshield or the rear window (wagon only).

Do not allow a wiper arm to contact the windshield glass or the rear window (wagon only) without a wiper blade inserted.

For your convenience, we recommend that you have this work carried out at an authorized Mercedes-Benz Center.

### Placing wiper arms in vertical position



Wiper arms in vertical position

- ▶ Make sure the hood is fully closed.

## Replacing wiper blades

**Vehicles with SmartKey**

- ▶ Turn the SmartKey in the starter switch to position **1**.
- ▶ Turn combination switch to wiper setting **—**.
- ▶ With wiper arms in vertical position, turn the SmartKey in the starter switch to position **0**.
- ▶ Remove the SmartKey from the starter switch.

**Vehicles with KEYLESS-GO**

- ▶ Turn off the engine.  
With the driver's door closed, the starter switch is now in position **1**.
- ▶ Turn combination switch to wiper setting **—**.
- ▶ With wiper arms in vertical position, open the driver's door.  
The starter switch is set to position **0**, same as the SmartKey removed from the starter switch.
- ▶ Turn combination switch to wiper setting **0**.

**Removing wiper blades****Front wiper blades**

- ⚠ Do not pull on the wiper blade inserts. They could tear.
- ▶ Fold the wiper arms forward until they engage.

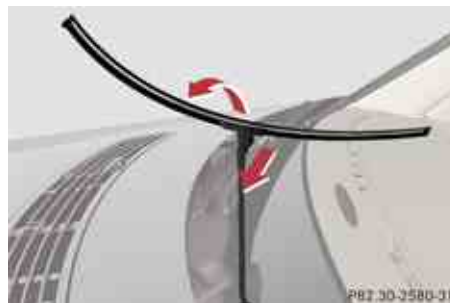

- ▶ Turn the wiper blade at a right angle to the wiper arm.
- ▶ Slide the wiper blade sideways out of the retainer.

**Rear wiper blade (wagon)**

- ⚠ Do not pull on the wiper blade insert. It could tear.



- ① Wiper blade
- ② Tab
- ③ Attachment
- ④ Removing
- ▶ Fold the wiper arm away from the rear window until it engages.
- ▶ Turn wiper blade ① at a right angle to wiper arm.
- ▶ Press tab ② down and push wiper blade ① downward in direction of arrow ④.
- ▶ Remove wiper blade ①.

### Replacing wiper blades

#### Installing wiper blades

##### Front wiper blades

- ▶ Slide the wiper blade onto wiper arm until it locks in place.
- ▶ Rotate the wiper blade into position parallel to the wiper arm.
- ▶ Fold the wiper arm backward to rest on the windshield.  
Make sure you hold on to the wiper when folding the wiper arm back.

**!** Make sure the wiper blades are properly installed. Improperly installed wiper blades may cause windshield damage.

##### Rear wiper blade (wagon)



- ① Wiper blade
- ② Tab
- ③ Attachment
- ④ Installing

- ▶ Slide wiper blade ① into attachment ③ in direction of arrow ④.
- ▶ Let tab ② latch into attachment ③ until it locks in place.
- ▶ Check whether the wiper blade is securely fastened.
- ▶ Fold the wiper arm to rest on the rear window.  
Make sure to hold on to the wiper when folding the wiper arm back.

**!** Make sure the wiper blade is properly installed. An improperly installed wiper blade may cause rear window damage.

## Flat tire

## Flat tire

## Safety notes

Your vehicle may be equipped with:

- a TIREFIT kit (your vehicle does not have a spare wheel)
- a Minispare wheel
- a spare wheel with collapsible tire

For information on your vehicle's equipment, see "Rims and tires" (▷ page 384).

 **Warning!**

The dimensions of the spare wheel are different from those of the road wheels. As a result, the vehicle handling characteristics change when driving with a spare wheel mounted. Adapt your driving style accordingly.

The spare wheel is for temporary use only. When driving with spare wheel mounted, ensure proper tire inflation pressure and do not exceed a vehicle speed of 50 mph (80 km/h).

Contact the nearest authorized Mercedes-Benz Center as soon as possible to have the spare wheel replaced with a regular road wheel.

Never operate the vehicle with more than one spare wheel mounted.

Do not switch off the ESP® when a spare wheel is mounted.

## Preparing the vehicle

- ▶ Vehicles with AIRMATIC DC: Make sure the vehicle level is set to normal level (▷ page 172).
  - ▶ Park the vehicle in a safe distance from moving traffic on a hard, flat surface when possible.
  - ▶ Turn on the hazard warning flasher.
  - ▶ Turn the steering wheel so that the front wheels are in a straight-ahead position.
  - ▶ Engage the parking brake.
  - ▶ Shift the automatic transmission into park position **P**.
  - ▶ Turn off the engine.
  - ▶ Remove the SmartKey from the starter switch.
- or
- ▶ Vehicles with KEYLESS-GO: Open the driver's door (this puts the starter switch in position **0**, same as with the SmartKey removed from the starter switch). The driver's door can then be closed again.

Open doors only when conditions are safe to do so.

- ▶ Have any passenger exit the vehicle at a safe distance from the roadway. Open doors only when conditions are safe to do so.

## Sealing tires with TIREFIT

This section applies to E 63 AMG (wagon) with third-row seat only.

Small tire punctures, particularly those in the tread, can be sealed with TIREFIT.

TIREFIT can be used in ambient temperatures down to -4°F (-20°C).

 **Warning!**

TIREFIT is a limited repair device. TIREFIT cannot be used for cuts or punctures larger than approximately 0.16 in (4 mm) and tire damage caused by driving with extremely low tire inflation pressure, or on a flat tire, or a damaged wheel.

Do not drive the vehicle under such circumstances.

Contact the nearest authorized Mercedes-Benz Center for assistance or call Roadside Assistance.

### Flat tire

- ▶ Foreign objects (e.g. screws or nails) should not be removed from the tire.
- ▶ Take the TIREFIT kit, the sticker, and the electric air pump out of the cargo compartment (▷ page 290).

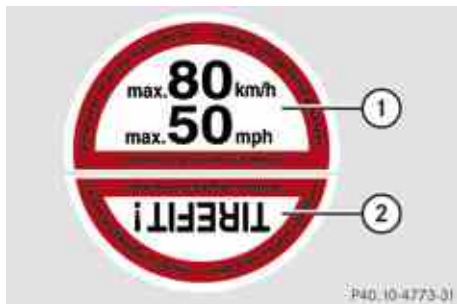

Two-part sticker

- ① Sticker for instrument cluster
- ② Sticker for wheel

- ▶ Attach sticker part ① where it will be easily seen by the driver on the instrument cluster.
- ▶ Attach sticker part ② to the damaged tire (close to the tire valve).

#### **⚠ Warning!**

Take care not to allow the contents of TIREFIT to come in contact with hair, eyes

or clothing. TIREFIT is harmful if inhaled, swallowed or absorbed through the skin - causes skin, eye and respiratory irritation. Any contact with eyes or skin should be flushed immediately with plenty of water. If clothing comes in contact with TIREFIT, change clothing as soon as possible. In case of allergic reaction or rash, consult a physician immediately.

#### **⚠ Warning!**

Keep TIREFIT out of reach of children. If swallowed, rinse mouth immediately with plenty of water and drink plenty of water. Do not induce vomiting! Consult a physician immediately. Keep away from open flame or heat source.

- ⓘ If sealant has leaked out, let it dry. You can then peel it off. If clothing has come in contact with TIREFIT, have it dry-cleaned with perchloroethylene as soon as possible.

#### **⚠ Warning!**

Observe safety instructions on air pump label.

Your vehicle may be equipped with either of two versions of the electric air pump:

- **Version 1:** The air hose with pressure gauge and the electrical plug are located behind a flap.
- **Version 2:** The pressure gauge is located in the pump housing. The air hose and electrical plug are located at the bottom of the pump housing.

The following description applies to both versions. Differences in usage are expressly declared.



Version 1

- ① TIREFIT container
- ② Notch
- ③ Electric air pump switch
- ④ Electrical plug

Flat tire

- ⑤ Air hose
- ⑥ Flange
- ⑦ Flap

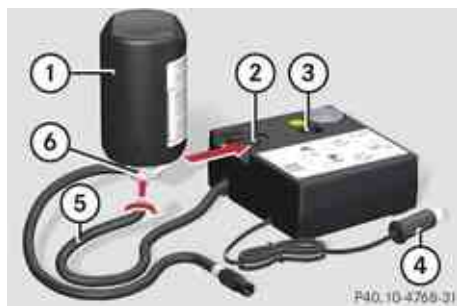

Version 2

- ① TIREFIT container
- ② Notch
- ③ Electric air pump switch
- ④ Electrical plug
- ⑤ Air hose
- ⑥ Flange

- ▶ **Version 1 only:** Open flap ⑦ on the electric air pump.
- ▶ Pull plug ④ and air hose ⑤ out of the pump housing.
- ▶ Screw the air pump's air hose ⑤ onto flange ⑥ of TIREFIT container ①.

- ▶ Stick TIREFIT container ① upside down into notch ② of the electric air pump.



- ⑧ Filler hose
- ⑨ Tire valve

- ▶ Unscrew the valve cap of the damaged tire from tire valve ⑨.



Version 1

- ⑩ Vent screw
- ⑪ Pressure gauge

- ▶ **Version 1 only:** Close vent screw ⑩ on pressure gauge ⑪.
  - ▶ Screw filler hose ⑧ onto tire valve ⑨.
  - ▶ Insert electrical plug ④ into the cigarette lighter socket (▷ page 223) or a power outlet (▷ page 224).
  - ▶ Turn the SmartKey in the starter switch to position 1.
- or
- ▶ Vehicles with KEYLESS-GO: Press the KEYLESS-GO start/stop button once. Do not depress the brake pedal.

### Flat tire

- ▶ Press **I** on electric air pump switch ③.

The electric air pump is switched on and inflates the tire.

- i** First, the sealing is pumped into the tire. The pressure may briefly rise to up to 73 psi (5 bar). This is normal and not an indication of a malfunction. Do not switch off the electric air pump.

- ▶ Let the electric air pump inflate the tire for approximately 5 minutes. The pressure gauge must display at least 26 psi (1.8 bar).

#### **Warning!**

The air hose can become hot during inflation. Please exercise appropriate caution.

- !** Do not operate the electric air pump longer than 8 minutes without interruption. Otherwise it may overheat.

You may operate the air pump again after it has cooled off.

- ▶ If the tire inflation pressure of at least 26 psi (1.8 bar) is not attained, turn off the electric air pump by pressing **0** on electric air pump switch ③.
- ▶ Detach filler hose ⑧ from tire valve ⑨.

- ▶ Drive vehicle back or forth very slowly approximately 30 ft (10 m). This serves to better distribute the TIREFIT sealant material inside the tire.
- ▶ Unscrew the air pump's air hose ⑤ from flange ⑥ of TIREFIT container ①.
- ▶ Screw air hose ⑤ onto tire valve ⑨.
- ▶ Inflate the tire again.

#### **Warning!**

If a tire inflation pressure of 26 psi (1.8 bar) is not attained, the tire is too severely damaged for TIREFIT to provide a reliable tire repair.

In this case, TIREFIT cannot properly seal the tire.

Do not drive the vehicle.

Contact the nearest Mercedes-Benz Center or call Roadside Assistance.

- ▶ After attaining a tire inflation pressure of at least 26 psi (1.8 bar), press **0** on electric air pump switch ③. The electric air pump is switched off.
- ▶ Turn the SmartKey in the starter switch to position **0**.

or

- ▶ Vehicles with KEYLESS-GO: Press the KEYLESS-GO start/stop button twice. Do not depress brake pedal.
- ▶ Detach the electric air pump.

#### **Warning!**

The air hose may still be hot. Exercise proper caution to avoid burning yourself when detaching the electric air pump.

- ▶ Place the electric air pump back in the cargo compartment.
- ▶ Close the cargo compartment.
- ▶ Drive off immediately. The TIREFIT sealant will distribute itself evenly inside the tire.

#### **Warning!**

Do not exceed a vehicle speed of 50 mph (80 km/h). A TIREFIT repair is not designed to operate at higher speeds.



## Flat tire

The sticker must be attached on the instrument cluster where it will be easily seen by the driver.

Vehicle handling characteristics of a TIREFIT repaired tire may change. Adapt your driving accordingly.

- ▶ After driving the vehicle for an initial 10 minutes, check the tire inflation pressure using pressure gauge on the air pump.

### ⚠ Warning!

If tire inflation pressure has fallen below 20 psi (1.3 bar) do not continue to drive the vehicle.

Park your vehicle safely away from the roadway and contact the nearest authorized Mercedes-Benz Center or Roadside Assistance.

Have the damaged tire replaced.

If the tire inflation pressure is at least 20 psi (1.3 bar), inflate or deflate the tire to the correct tire inflation pressure (see Tire and Loading Information placard on the driver's door B-pillar):

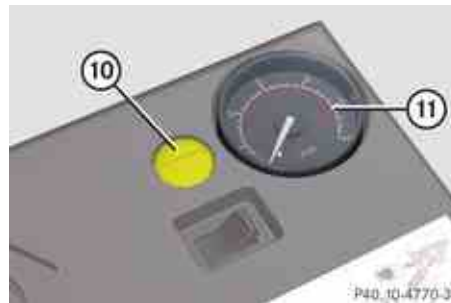

Version 2

⑩ Deflate button

⑪ Pressure gauge

- ▶ To increase tire inflation pressure: Switch on the electric air pump.
- ▶ **Version 1:** To decrease tire inflation pressure, open vent screw ⑩ on pressure gauge ⑪ (▷ page 357).

or

- ▶ **Version 2:** To decrease tire inflation pressure, press yellow deflate button ⑩

located in air pump housing next to pressure gauge ⑪.

### ⚠ Warning!

Follow recommend inflation pressures.

Do not overinflate tires. Overinflating tires can result in sudden deflation (blowout) because they are more likely to become punctured or damaged by road debris, potholes, etc.

Do not underinflate tires. Underinflated tires wear unevenly, adversely affect handling and fuel economy, and are more likely to fail from being overheated.

Do not overload the tires by exceeding the specified vehicle capacity weight (as indicated by the label on the pillar in the driver's door opening). Overloading the tires can overheat them, possibly causing a blowout.

- ▶ Drive to the nearest qualified workshop, e.g. an authorized Mercedes-Benz Center, to have the damaged tire replaced.
- ▶ Recommended duration of use: A maximum of 300 miles (500 km) at 50 mph (80 km/h) or below with the recommended tire inflation pressure.



### Flat tire

- ▶ Contact an authorized Mercedes-Benz Center as soon as possible to obtain a new TIREFIT kit.
- ▶ Bring used TIREFIT materials to an authorized Mercedes-Benz Center for proper disposal.
- ▶ Replace your TIREFIT container every 4 years. Replacement containers are available at any authorized Mercedes-Benz Center.

### Mounting the spare wheel

#### Introduction

- ▶ Prepare the vehicle as described (▷ page 355).
- ▶ Take the following out of the vehicle:
  - spare wheel
  - jack
  - wheel wrench
  - collapsible wheel chock
  - alignment bolt
  - electric air pump (required for vehicles with spare wheel with collapsible tire only)

For information on where to find the respective items, see “Where will I find ...?” (▷ page 290) and (▷ page 293).

#### Lifting the vehicle

##### **Warning!**

When jacking up the vehicle, only use the jack which has been specifically approved by Mercedes-Benz for your vehicle.

The jack is designed exclusively for jacking up the vehicle at the jack take-up brackets built into both sides of the vehicle. Make sure the jack arm is fully seated in the jack take-up bracket. The jack must always be vertical when in use, especially on inclines or declines.

The jack is intended only for lifting the vehicle briefly for wheel changes. It is not suited for performing maintenance work under the vehicle. To help avoid personal injury, use the jack only to lift the vehicle during a wheel change.

Never get beneath the vehicle while it is supported by the jack. Keep hands and feet away from the area under the lifted vehicle. Always lower the vehicle onto sufficient capacity jackstands before working under the vehicle.

Always firmly set the parking brake and block the wheels with wheel chocks or other sizeable objects before raising the vehicle with the jack. Do not disengage the parking brake while the vehicle is raised.

Make sure that the ground on which the vehicle is standing and where you place the jack is solid, level and not slippery. If necessary, use a large underlay. On slippery surfaces, such as tiled floors, you should use a non-slip underlay, for example a rubber mat.

Do not use wooden blocks or similar objects to support the jack. Otherwise the jack may not be able to achieve its load-bearing capacity if it is not at its full height. Never start the engine when the vehicle is raised.

Also observe the notes on the jack.

- ▶ Prevent the vehicle from rolling away by blocking wheels with wheel chocks or other sizeable objects.

One wheel chock is included with the vehicle tool kit (▷ page 290). For information on setting up the collapsible wheel chock, see (▷ page 292).

## Flat tire

When changing wheel on a level surface:

- ▶ Place the wheel chock in front of and another wheel chock or other sizeable object behind the wheel that is diagonally opposite to the wheel being changed.

Always try lifting the vehicle using the jack on a level surface. However, should circumstances require you to do so on a hill, place the wheel chock and another sizeable object as follows:

- ▶ Place wheel chocks or other sizeable objects on the downhill side blocking both wheels of the axle not being worked on.

**⚠ Warning!**

Only jack up the vehicle on level ground or on slight inclines/declines. Otherwise, the vehicle could fall off the jack and injure you or others.



① Wheel wrench

- ▶ On wheel to be changed, loosen but do not yet remove the wheel bolts (approximately one full turn with wrench ①).

The jack take-up brackets are located directly behind the front wheel housings and in front of the rear wheel housings.

**⚠ Warning!**

The jack is designed exclusively for jacking up the vehicle at the jack take-up brackets. Make sure the jack arm is fully seated in the jack take-up bracket.

If you do not position the jack correctly in the jack take-up bracket, the vehicle can fall off the jack and seriously or fatally injure you or others.

- ❗ Do not position the jack on the body of the vehicle, as this may cause damage to the vehicle.



② Take-up bracket

③ Jack

④ Crank

- ▶ Place jack ③ on firm ground.
- ▶ Position jack ③ under take-up bracket ② so that it is always vertical as seen from the side, even if the vehicle is parked on an incline.

### Flat tire

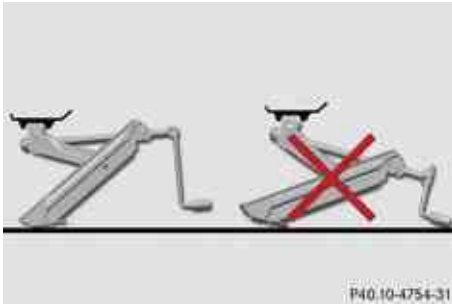

- ▶ Turn crank ④ clockwise until jack ③ is fully seated in take-up bracket ② and the jack base evenly meets the ground.
- ▶ Jack up the vehicle until the wheel is a maximum of 1.2 in (3 cm) from the ground.

### Removing the wheel



- ① Alignment bolt
- ▶ Unscrew uppermost wheel bolt and remove it.
- ▶ Replace this wheel bolt with alignment bolt ① supplied with the vehicle tool kit.
- ▶ Remove the remaining bolts.
- ❗ Do not place wheel bolts in sand or dirt. This could result in damage to the wheel bolts and wheel hub threads.
- ▶ Remove the wheel.

### Attaching the spare wheel

#### ⚠ Warning!

Vehicles with spare wheel with collapsible tire only: Inflate collapsible tire only after the wheel is properly attached.

Inflate the collapsible tire using the electric air pump before lowering the vehicle.

#### ⚠ Warning!

Always replace wheel bolts that are damaged or rusted.

Never apply oil or grease to wheel bolts.

Damaged wheel hub threads should be repaired immediately. Do not continue to drive under these circumstances! Contact an authorized Mercedes-Benz Center or call Roadside Assistance.

Incorrect wheel bolts or improperly tightened wheel bolts can cause the wheel to come off. This could cause an accident. Be sure to use the correct wheel bolts.

#### ⚠ Warning!

Only use genuine Mercedes-Benz wheel bolts. Other wheel bolts may come loose.

Do not tighten the wheel bolts when the vehicle is raised. Otherwise the vehicle could fall off the jack.

## Flat tire

- ▶ Clean contact surfaces of wheel and wheel hub.

**!** To avoid paint damage, place wheel flat against hub and hold it there while installing first wheel bolt.



- ▶ Guide the spare wheel onto the alignment bolt and push it on.
- ▶ Insert the wheel bolts and tighten them slightly.
- ▶ Unscrew the alignment bolt.
- ▶ Install last wheel bolt and tighten it slightly.
- ▶ **Vehicles with spare wheel with collapsible tire:** Continue the procedure by following the instructions under “Inflating the collapsible

tire” (> page 363) and then “Lowering the vehicle” (> page 365).

or

- ▶ **Vehicles with Minispare wheel:** Continue the procedure by following the instructions under “Lowering the vehicle” (> page 365).

### Inflating the collapsible tire

#### **Warning!**

Inflate collapsible tire only after the wheel is properly attached.

Inflate the collapsible tire using the electric air pump before lowering the vehicle.

#### **Warning!**

Observe safety instructions on air pump label.

- !** Do not lower the vehicle before inflating the collapsible tire. Otherwise the rim may be damaged.

Your vehicle may be equipped with either of two versions of the electric air pump:

- **Version 1:** The air hose with pressure gauge and the electrical plug are located behind a flap.
- **Version 2:** The pressure gauge is located in the pump housing. The air hose and electrical plug are located at the bottom of the pump housing.

The following description applies to both versions. Differences in usage are expressly declared.

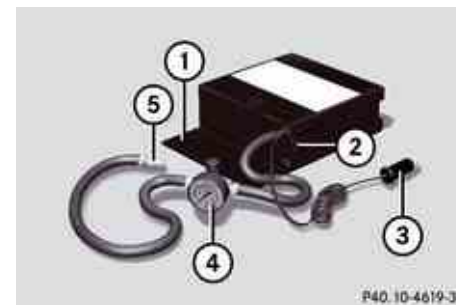

Version 1

- ① Flap
- ② Air pump switch
- ③ Electrical plug

▷▷

## Flat tire

- ④ Air hose with pressure gauge and vent screw
- ⑤ Union nut

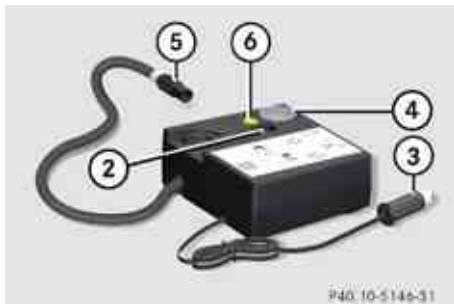

### Version 2

- ② Air pump switch
  - ③ Electrical plug
  - ④ Pressure gauge
  - ⑤ Union nut
  - ⑥ Deflate button
- ▶ **Version 1 only:** Open flap ① on electric air pump.
  - ▶ **Version 1 only:** Pull out electrical plug ③ and air hose with pressure gauge ④.
  - ▶ **Version 2 only:** Pull electrical plug ③ and the air hose out of the pump housing bottom.

- ▶ **Version 1 only:** Close vent screw on air hose ④.
- ▶ Remove the valve cap from the collapsible tire valve.
- ▶ Screw union nut ⑤ onto the collapsible tire valve.
- ▶ Make sure air pump switch ② is set to **0**.
- ▶ Insert electrical plug ③ into the cigarette lighter socket (▷ page 223) or a power outlet (▷ page 224).
- ▶ Turn the SmartKey in the starter switch to position **1**.

or

- ▶ Vehicles with KEYLESS-GO: Press the KEYLESS-GO start/stop button on the gear selector lever once. Do not depress the brake pedal.
- ▶ Press **I** on electric air pump switch ②. The electric air pump switches on and inflates the collapsible tire.
- ▶ Inflate the collapsible tire to the recommended tire inflation pressure as specified for your vehicle (▷ page 389). This should take approximately 5 minutes.

### **⚠ Warning!**

The air hose and the union nut can become hot during inflation. Exercise proper

caution to avoid burning yourself when using the equipment.

- !** Do not operate the electric air pump longer than 8 minutes without interruption. Otherwise it may overheat. You may operate the air pump again after it has cooled off.

- !** Compare the recommended tire inflation pressure for your vehicle with the tire inflation pressure on the yellow label located on the spare wheel rim.

If the tire inflation pressure on the yellow label on the spare wheel rim differs from the values given in this Operator's Manual, inflate the tire to the recommended tire inflation pressure given on the yellow label on the spare wheel rim.

- ▶ Press **0** on electric air pump switch ②.
- ▶ Turn the SmartKey in the starter switch to position **0**.

or

- ▶ Vehicles with KEYLESS-GO: Press the KEYLESS-GO start/stop button on the gear selector lever twice. Do not depress the brake pedal.

## Flat tire

- ▶ **Version 1 only:** If the tire inflation pressure is above the recommended tire inflation pressure as specified for your vehicle (▷ page 389), decrease tire pressure using the vent screw on air hose ④.
- ▶ **Version 2 only:** If the tire inflation pressure is above the recommended tire inflation pressure as specified for your vehicle (▷ page 389), decrease tire pressure using deflate button ⑥.

### ⚠ Warning!

Follow recommend inflation pressures.

Do not overinflate tires. Overinflating tires can result in sudden deflation (blowout) because they are more likely to become punctured or damaged by road debris, potholes, etc.

Do not underinflate tires. Underinflated tires wear unevenly, adversely affect handling and fuel economy, and are more likely to fail from being overheated.

- ▶ Detach the electric air pump.
- ▶ Reinstall collapsible tire valve cap.
- ▶ **Version 1 only:** Store electrical plug ③ and air hose ④ behind flap ① and place the electric air pump back in its designated storage space.

- ▶ **Version 2 only:** Store electrical plug ③ and the air hose back into the pump housing bottom.
- ▶ Place the electric air pump back in its designated storage space.
- ▶ Lower the vehicle.

### Lowering the vehicle

#### ⚠ Warning!

Vehicles with spare wheel with collapsible tire only: Inflate collapsible tire only after the wheel is properly attached.

Inflate the collapsible tire using the electric air pump before lowering the vehicle.

- ▶ Lower the vehicle by turning crank counterclockwise until the vehicle is resting fully on its own weight.
- ▶ Remove the jack.

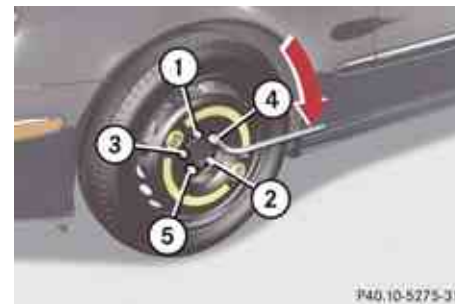

① - ⑤ Wheel bolts

- ▶ Tighten the five wheel bolts evenly, following the diagonal sequence illustrated (① to ⑤), until all bolts are tight. Observe a tightening torque of 96 lb-ft (130 Nm).

#### ⚠ Warning!

Have the tightening torque checked after changing a wheel. The wheels could come loose if they are not tightened to a torque of 96 lb-ft (130 Nm).

- ▶ Fully collapse the jack, with handle folded in (storage position), see (▷ page 292).
- ▶ Store the jack and the other vehicle tools in the designated storage space.



For information on storing the spare wheel after it has been replaced by a regular road wheel, see (▷ page 293).

▷▷

### Bleeding the fuel system (diesel engine only)

- i** Vehicles with spare wheel:  
Some tire sizes do not allow the damaged road wheel to be stored in the spare wheel well in the trunk/cargo compartment. It should then be transported in the trunk/cargo compartment wrapped in the protective film/bag that comes with the spare wheel.
- i** Vehicles with TPMS or Advanced TPMS:  
Do not restart the tire inflation pressure monitor until a full size wheel/tire with functioning sensor has been placed back into service on the vehicle.

### Bleeding the fuel system (diesel engine only)

Driving the vehicle until the fuel tank is empty is not recommended. Otherwise, air may be sucked into the fuel system. If this happens, the malfunction indicator lamp  (USA only) or  (Canada only) comes on and the engine may not start immediately after refueling the vehicle.



After refueling:

- ▶ Make sure the automatic transmission is in park position **P**.
- ▶ Do not depress the accelerator.
- ▶ Turn the SmartKey in the starter switch to position **2** for at least 10 seconds.
- ▶ Return the SmartKey in the starter switch to position **0**.
- ▶ Turn the SmartKey in the starter switch to position **3** and hold it there for a maximum of 40 seconds or until the engine runs surge-free.

If the engine does not start:

- ▶ Wait for approximately 2 minutes.
- ▶ Turn the SmartKey in the starter switch to position **3** and hold it there for a maximum of 40 seconds or until the engine runs surge-free.

If the engine still does not start, do not make any further attempts to start the engine. Contact an authorized Mercedes-Benz Center or call Roadside Assistance (▷ page 226).

- i** When the malfunction indicator lamp  (USA only) or  (Canada only) in the instrument cluster has been illuminated for the above condition, it will remain illuminated until the engine was cycled on and off four times in a row.



## Battery

## Safety notes

A battery should always be sufficiently charged in order to achieve its rated service life. Refer to Maintenance Booklet for battery maintenance intervals.

If you use your vehicle mostly for short-distance trips, you will need to have the battery charge checked more frequently.

When replacing a battery, always use a battery approved by Mercedes-Benz.

If you do not intend to operate your vehicle for an extended period of time, contact an authorized Mercedes-Benz Center about steps you need to observe.

**⚠ Warning!**

Observe all safety instructions and precautions when handling automotive batteries.



Risk of explosion.



Fire, open flames and smoking are prohibited when handling batteries. Avoid creating sparks.



Battery acid is caustic. Do not allow it to come into contact with skin, eyes or clothing.

Wear suitable protective clothing, especially gloves, apron and faceguard.



Wear eye protection.

Rinse any acid spills immediately with clear water. Contact a physician if necessary.



Keep children away.



Follow the instructions in this Operator's Manual.

Batteries contain materials that can harm the environment if disposed of improperly. Large 12-volt storage batteries contain lead. Recycling of batteries is the preferred method of disposal. Many states (USA only) or provinces (Canada only) require sellers of batteries to accept old batteries for recycling.

**⚠ Warning!**

Failure to follow these instructions can result in severe injury or death.

Never lean over batteries while connecting. You might get injured.

Battery fluid contains sulfuric acid. Do not allow this fluid to come in contact with eyes, skin or clothing. In case it does, immediately flush affected area with water and seek medical help if necessary.

A battery will also produce hydrogen gas, which is flammable and explosive. Keep flames or sparks away from battery, avoid improper connection of jumper cables, smoking etc.

**⚠ Warning!**

Do not place metal objects on the battery as this could result in a short circuit.

Use leak-proof batteries only to avoid the risk of acid burns in the event of an accident.

Take care that you do not become statically charged, e.g. by wearing synthetic clothing or rubbing against textiles. For this reason, you also should not pull or push the battery over carpets or other synthetic materials.

### Battery

Never touch the battery first. First touch the outside body of the vehicle in order to release any possible electrostatic charges.

Do not rub the battery with rags or cloths. The battery could explode if touched due to electrostatic charge or due to spark formation.

**!** The battery is a Valve-Regulated Lead Acid (VRLA) battery, also referred to as “fleece” battery.

Such batteries do not require topping-up of the electrolyte level. VRLA batteries therefore do not have cell caps and the battery cover is non-removable. Do not attempt to open the battery as otherwise the battery will be damaged.

Even though VRLA batteries do not require topping-up of the electrolyte level and cannot be opened to check the electrolyte level, the battery condition must be checked periodically by performing a battery conductance test. Refer to Maintenance Booklet for battery condition testing intervals.

The factory-equipped VRLA battery is leak-proofed. Only use a battery as replacement that has the same security features and is

of identical size, voltage, and capacity as the factory-equipped battery.

**!** As with any other battery, have the battery disconnect at a qualified workshop or an authorized Mercedes-Benz Center if you do not intend to operate your vehicle for an extended period of time to prevent battery discharge. You may also connect an accessory battery charge unit expressly approved by Mercedes-Benz for your vehicle model to maintain the battery charge. Contact an authorized Mercedes-Benz Center for further information.

The battery, the battery ventilation hose and the lateral plug must always be securely installed when the vehicle is in operation.

**!** Never loosen or detach battery terminal clamps while the engine is running or the SmartKey is in the starter switch or KEYLESS-GO button is in position 1. Otherwise the alternator and other electronic components could be severely damaged.

Have the battery checked regularly at an authorized Mercedes-Benz Center.

Refer to Maintenance Booklet for maintenance intervals or contact an

authorized Mercedes-Benz Center for further information.

**i** After battery power was interrupted, do the following:

- Synchronize the power windows (▷ page 122).
- Synchronize the tilt/sliding sunroof (▷ page 196) or the tilt/sliding panel (▷ page 199).

### Charging the battery

#### **Warning!**

Never charge a battery while still installed in the vehicle unless the accessory battery charge unit approved by Mercedes-Benz is being used. Gases may escape during charging and cause explosions that may result in paint damage, corrosion or personal injury.

An accessory battery charge unit specially adapted for Mercedes-Benz vehicles and tested and approved by Mercedes-Benz is available, permitting the charging of the battery in its installed position. Contact an authorized Mercedes-Benz Center for information and availability.

## Jump starting

Charge battery in accordance with the separate instructions for the accessory battery charger.

Have batteries charged at an authorized Mercedes-Benz Center. If you charge the batteries yourself, follow the operating instructions for your charging device.

Only use a battery charge unit with a maximum charging voltage of 14.8 V.

- ▶ Charge battery in accordance with the instructions of the battery charger manufacturer.

## Jump starting

**⚠ Warning!**

Failure to follow these directions will cause damage to the electronic components, and can lead to a battery explosion and severe injury or death.

Never lean over batteries while connecting or jump starting. You might get injured.

Battery fluid contains sulfuric acid. Do not allow this fluid to come in contact with eyes, skin or clothing. In case it does, immediately flush affected area with water, and seek medical help if necessary.

A battery will also produce hydrogen gas, which is flammable and explosive. Keep flames or sparks away from battery, avoid improper connection of jumper cables, smoking, etc.

Attempting to jump start a frozen battery can result in it exploding, causing personal injury.

Read all instructions before proceeding.

- !** Do not tow-start the vehicle. You could otherwise seriously damage the automatic

transmission which is not covered by the Mercedes-Benz Limited Warranty.

- !** Jump starting should only be performed using the jump-start terminals located in the engine compartment (wagon).

Avoid repeated and lengthy starting attempts.

Do not attempt to start the engine using a battery quick-charge unit.

If the engine does not run after several unsuccessful starting attempts, have it checked at the nearest authorized Mercedes-Benz Center.

Excessive unburned fuel generated by repeated failed starting attempts may damage the catalytic converter<sup>21</sup> and may present a fire risk.

Make sure the jumper cables do not have loose or missing insulation.

Make sure the cable clamps do not touch any other metal part while the other end is still attached to a battery.

<sup>21</sup> Vehicles with gasoline engine only.

### Jump starting

If the battery is discharged, the engine can be started with jumper cables and the fully charged battery of another vehicle or an equivalent starter pack. Observe the following:

- Access to the battery is not possible on all vehicles. If you cannot access the battery in your vehicle provide jump start power by an external battery or starter pack.
- Jump starting should only be performed when the engine and catalytic converter<sup>22</sup> are cold.
- Do not start the engine if the battery is frozen. Let the battery thaw out first.
- Only jump start from batteries with the same voltage rating (12 V). Jump starting with a more powerful battery could damage the vehicle's electrical system, which will not be covered by the Mercedes-Benz Limited Warranty.
- Only use jumper cables with sufficient cross-section and insulated terminal clamps.
- Always make sure the jumper cables are not on or near pulleys, fans or other parts

that move when an engine is started or running.

- Should the battery be drained completely, let the donating power source charge the vehicle for several minutes before reattempting the starting process.
- ▶ Make sure the two vehicles do not touch.
- ▶ Switch off all electrical consumers.
- ▶ Engage the parking brake.
- ▶ Make sure the automatic transmission is in park position **P**.

#### Sedan

The battery is located in the trunk underneath the luggage box (▷ page 294).

- ▶ Open the trunk.

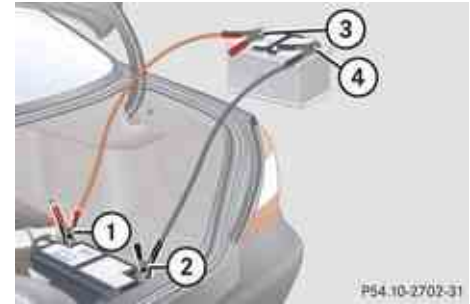

- ① Positive terminal of discharged battery
- ② Negative terminal of discharged battery
- ③ Positive terminal of charged battery
- ④ Negative terminal of charged battery

**!** Never invert the terminal connections!

- ▶ Connect positive terminals ① and ③ of the batteries with a jumper cable. Clamp the cable to positive terminal ③ of the charged battery first.
- ▶ Start engine of the vehicle with the charged battery and run at idle speed.
- ▶ Connect negative terminals ④ and ② of the batteries with a jumper cable. Clamp the cable to negative terminal ④ of the charged battery first.

<sup>22</sup> Vehicles with gasoline engine only.

## Jump starting

- ▶ Start engine of the vehicle with the discharged battery and run at idle speed. You can now turn on the electrical consumers. Do not switch on the headlamps under any circumstances.
- ▶ Remove the jumper cables first from negative terminals ② and ④ and then from positive terminals ① and ③. You can now switch on the headlamps.
- ▶ Have the battery checked at the nearest authorized Mercedes-Benz Center.

## Wagon

The jump-start terminals are located in the engine compartment on the right hand side.

- ▶ Open the hood.

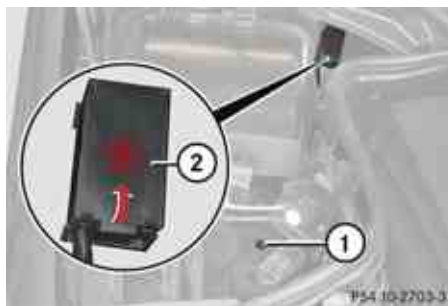

- ① Negative terminal
- ② Cover of positive terminal

**!** Never invert the terminal connections!

- ▶ Open cover of the positive terminal ②.
- ▶ Connect positive terminal of the charged battery with positive terminal ② with a jumper cable. Clamp the cable to positive terminal of the charged battery first.
- ▶ Start engine of the vehicle with the charged battery and run at idle speed.
- ▶ Connect negative terminal of the charged battery with negative terminal ① with a jumper cable. Clamp the cable to negative terminal ① of the charged battery first.

- ▶ Start engine of the vehicle with the discharged battery and run at idle speed. You can now turn on the electrical consumers. Do not switch on the headlamps under any circumstances.
- ▶ Remove the jumper cables first from negative terminals and then from positive terminals. You can now switch on the headlamps.
- ▶ Have the battery checked at the nearest authorized Mercedes-Benz Center.

### Towing the vehicle

#### Towing the vehicle

##### Safety notes

Mercedes-Benz recommends that the vehicle be transported with all wheels off the ground using flatbed or appropriate wheel lift/dolly equipment. This method is preferable to other types of towing.

**!** To prevent damage during transport, do not tie down vehicle by its chassis or suspension parts.

If circumstances do not permit the recommended towing methods, the vehicle may be towed with all wheels on the ground or front axle raised (except vehicles with 4MATIC) only so far as necessary to have the vehicle moved to a safe location where the recommended towing methods can be employed.

**!** Before towing the vehicle observe the following instructions:

- Do not tow-start the vehicle. You could otherwise seriously damage the automatic transmission which is not

covered by the Mercedes-Benz Limited Warranty.

- Do not tow with sling-type equipment. Towing with sling-type equipment over bumpy roads will damage radiator and supports.
- Towing of the vehicle should only be done using the properly installed towing eye bolt. Never attach a tow cable, tow rope or tow rod to the vehicle chassis, frame or suspension parts.

**i** If the battery is disconnected or discharged

- the SmartKey will not turn in the starter switch
- the automatic transmission will remain in park position **P**
- For more information see “Battery” (▷ page 367) or “Jump starting” (▷ page 369).
- For information on manually unlocking the gear selector lever, see (▷ page 345)

#### Installing towing eye bolt

Depending on whether you are towing a vehicle or you are being towed, the towing eye bolt can be screwed into threaded holes which are located behind covers on each bumper.

The towing eye bolt is supplied with the vehicle tool kit, located in the storage compartment underneath the trunk/cargo compartment floor (▷ page 290).

- ▶ Take the vehicle tool kit out of the trunk/cargo compartment.

#### Removing cover in front bumper



① Cover

## Towing the vehicle

- ▶ Press mark on cover ① as indicated by the arrow.
- ▶ Lift cover ① off to reveal the threaded hole for the towing eye bolt.

### Removing cover in rear bumper

#### **Warning!**

In order to avoid possible serious burns or injury, use extreme caution when removing the rear cover, because the rear exhaust pipe is extremely hot.



① Cover

- ▶ Press on cover ① as indicated by the arrow.
- ▶ Fold cover ① down to reveal the threaded hole for the towing eye bolt.

### Fixing towing eye bolt



Example illustration front bumper

- ① Towing eye bolt
- ▶ Take the towing eye bolt and the wheel wrench from the vehicle tool kit.
- ▶ Screw towing eye bolt ① clockwise into threaded hole to its stop.
- ▶ Insert wheel wrench into towing eye and tighten towing eye bolt ① by turning it clockwise.

### Removing towing eye bolt

- ▶ Loosen towing eye bolt ① counterclockwise with wheel wrench.
- ▶ Unscrew towing eye bolt ①.
- ▶ **Reinstalling cover:** Fit cover ① (> page 372) and snap it into place.
- ▶ Store the towing eye bolt and wheel wrench back into the vehicle tool kit.

### Towing with all wheels on the ground

#### **Warning!**

If circumstances require towing the vehicle with all wheels on the ground, always tow with a tow bar if:

- the engine will not run
- there is a malfunction in the brake system
- there is a malfunction in the power supply or in the vehicle's electrical system

This is necessary to adequately control the towed vehicle.

### Towing the vehicle

Prior to towing the vehicle with all wheels on the ground, make sure the SmartKey is in starter switch position **2**.

If the SmartKey is left in the starter switch position **0** for an extended period of time, it can no longer be turned in the switch. In this case, the steering is locked. To unlock, remove SmartKey from starter switch and reinsert.

#### **Warning!**

With the engine not running, there is no power assistance for the brake and steering systems. In this case, it is important to keep in mind that a considerably higher degree of effort is necessary to brake and steer the vehicle. Adapt your driving accordingly.

- ▶ Make sure the ignition is switched on.
- ▶ With the vehicle at a standstill, depress the brake pedal and keep it pressed.
- ▶ Shift the automatic transmission into neutral position **N**.
- ▶ Release the brake pedal.
- ▶ If engaged, release the parking brake.
- ▶ Switch on the hazard warning flasher (> page 114).

**!** The vehicle may be towed only for distances up to 30 miles (50 km) and at a speed not to exceed 30 mph (50 km/h).

**i** To signal turns while being towed with the hazard warning flasher in use you can activate the combination switch for the left or right turn signal in the usual manner – only the selected turn signal will operate. Upon canceling the turn signal, the hazard warning flasher will operate again.

### Towing with front axle raised

**!** Vehicles with 4MATIC: Do not tow with the front axle raised. Doing so could damage the transfer case, which is not covered by the Mercedes-Benz Limited Warranty.

All wheels must be on or off the ground. Observe instructions for towing the vehicle with all wheels on the ground.

When towing the vehicle with the front axle raised, the wheels on the ground have to move freely.

- ▶ Make sure the ignition is switched on.
- ▶ With the vehicle at a standstill, depress the brake pedal and keep it pressed.

- ▶ Shift the automatic transmission into neutral position **N**.
- ▶ Release the brake pedal.
- ▶ If engaged, release the parking brake.
- ▶ Switch off the automatic central locking (> page 155).
- ▶ Switch off the ignition and leave the SmartKey in the starter switch.
- ▶ Switch on the hazard warning flasher (> page 114).

**!** Vehicles without 4MATIC:

Because the ESP<sup>®</sup> operates automatically, the engine and ignition must be shut off (SmartKey in starter switch position **0** or **1** or KEYLESS-GO start/stop button in position **0** or **1**) when the vehicle is being towed with the front axle raised.

Active braking action through the ESP<sup>®</sup> may otherwise seriously damage the brake system which is not covered by the Mercedes-Benz Limited Warranty.

**!** The vehicle may be towed only for distances up to 30 miles (50 km) and at a speed not to exceed 30 mph (50 km/h).



## Fuses

### Introduction

The electrical fuses in your vehicle serve to switch off malfunctioning power circuits.

If a fuse is blown, the components and systems secured by that fuse will stop operating.

### ⚠ Warning!

Only use fuses approved by Mercedes-Benz with the specified amperage for the system in question and do not attempt to repair or bridge a blown fuse. Using other than approved fuses or using repaired or bridged fuses may cause an overload leading to a fire, and/or cause damage to electrical components and/or systems. Have the cause determined and remedied by an authorized Mercedes-Benz Center.

A blown fuse must be replaced by an appropriate spare fuse (recognizable by its color or the fuse rating given on the fuse) of the amperage recommended in the fuse chart. Any Mercedes-Benz Center will be glad to advise you on this subject.

**i** In case of a blown fuse contact Roadside Assistance or an authorized Mercedes-Benz Center.

If a newly inserted fuse blows again, have the cause determined and rectified by an authorized Mercedes-Benz Center.

A fuse chart is located in the fuse box in the passenger compartment. The fuse chart explains the fuse allocation and fuse amperages.

### Before replacing fuses

- ▶ Engage the parking brake.
- ▶ Make sure the automatic transmission is in park position **P**.
- ▶ Switch off all electrical consumers.
- ▶ Turn off the engine.
- ▶ Remove the SmartKey from the starter switch.
- ▶ Vehicles with KEYLESS-GO: Open the driver's door (this puts the starter switch in position **0**, same as with the SmartKey removed from the starter switch). The driver's door then can be closed again.

### Fuse box in passenger compartment

**!** Do not use sharp objects such as a screwdriver to open the fuse box cover in the dashboard. You could damage the fuse box cover or the dashboard.

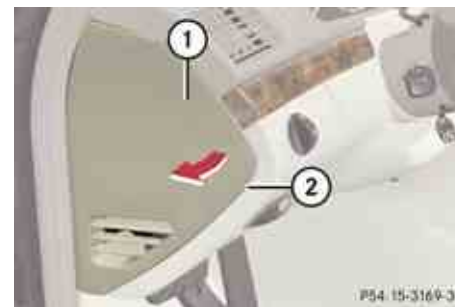

- ① Fuse box cover
- ② Recess in the cover

- ▶ Open the driver's door.
- ▶ Insert flat, blunt object as a lever in recess ② on the edge of cover ①.
- ▶ Loosen cover ① from the dashboard using the lever.
- ▶ Using your hands, pull cover ① in direction of arrow and remove it.

### Fuses

- ▶ **Closing:** Hook cover ① into the opening at the front.
- ▶ Press cover ① back on until it engages.

❗ The fuse box cover must be properly positioned as described to prevent moisture or dirt from entering the fuse box and possibly impairing fuse operation.

#### Fuse box in trunk (sedan)

Fuse box cover design may vary depending on vehicle equipment.

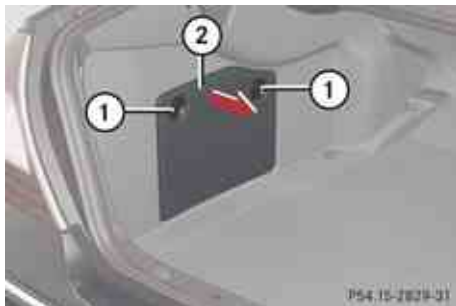

Cover with turn catches shown

- ① Catches
- ② Cover

- ▶ Open the trunk.

#### Opening cover (with turn catches)

- ▶ Turn catches ① counterclockwise and remove cover ②.

#### Closing cover (with turn catches)

- ▶ Install cover ②.
- ▶ Turn catches ① clockwise.

#### Opening cover (without turn catches)

- ▶ Hold cover ② at recess, press cover ② slightly together to release tabs from behind trim panel and then pull off cover ②.

#### Closing cover (without turn catches)

- ▶ Install cover ② with tabs on one side of trim panel, then press cover ② slightly together to install cover ② on other side of trim panel.

#### Fuse box in cargo compartment



- ① Button for unlocking trim panel
- ② Trim panel

- ▶ **Opening:** Open the cargo compartment.
- ▶ Press button ①.
- ▶ Fold down trim panel ②.
- ▶ **Closing:** Fold up trim panel ②.

**Vehicle equipment ..... 378**  
**Parts service ..... 378**  
**Warranty coverage ..... 378**  
**Identification labels ..... 379**  
**Engine ..... 381**  
**Rims and tires ..... 384**  
**Electrical system ..... 390**  
**Main dimensions ..... 391**  
**Weights ..... 393**  
**Fuels, coolants, lubricants etc. .... 394**



### Warranty coverage

#### Vehicle equipment

**i** This Operator's Manual describes all features, standard or optional, potentially available for your vehicle at the time of purchase. Please be aware that your vehicle might not be equipped with all features described in this manual.

#### Parts service

All authorized Mercedes-Benz Centers maintain a stock of Genuine Mercedes-Benz Parts required for maintenance and repair work. In addition, strategically located parts distribution centers provide quick and reliable parts service.

More than 300 000 different parts for Mercedes-Benz models are available.

Genuine Mercedes-Benz Parts are subjected to stringent quality inspections. Each part has been specifically developed, manufactured or selected for and adapted to Mercedes-Benz vehicles.

Therefore, Genuine Mercedes-Benz Parts should be installed.

**!** Do not use non-genuine Mercedes-Benz parts and accessories not authorized by Mercedes-Benz. Doing so could damage the vehicle, which is not covered by the Mercedes-Benz Limited Warranty. Also, it could compromise the vehicle's durability or safety.

#### Warranty coverage

Your vehicle is covered under the terms of the warranties printed in the Service and Warranty Information booklet.

Your authorized Mercedes-Benz Center will exchange or repair any defective parts originally installed in the vehicle in accordance with the terms of the following warranties:

- New Car Limited Warranty
- Emission System Warranty
- Emission Performance Warranty
- California, Connecticut, Maine, Massachusetts, New York, Pennsylvania, Rhode Island, and Vermont Emission Control Systems Warranty<sup>23</sup>
- State Warranty Enforcement Laws (Lemon Laws)

Replacement parts and accessories are covered by the Mercedes-Benz Parts and Accessories warranties, copies of which are available at any authorized Mercedes-Benz Center.

<sup>23</sup> Applicable to vehicles with gasoline engine only.

Identification labels

Loss of Service and Warranty Information booklet

Should you lose your Service and Warranty Information booklet, have an authorized Mercedes-Benz Center arrange for a replacement. It will be mailed to you.

Identification labels



① Certification label (on driver's door B-pillar)

The VehicIdentification Number (VIN) can be found in the following locations:

- on the certification label
- embossed underneath a cover in the front passenger footwell (▷ page 380)
- on the lower edge of the windshield (▷ page 380)



Example certification label (U.S. vehicles)

② VIN

③ Paintwork code



Example certification label (Canada vehicles)

② VIN

③ Paintwork code

### Identification labels

**i** Data shown on certification label are for illustration purposes only. These data are specific to each vehicle and may vary from data shown in the illustration. Refer to certification label on vehicle for actual data specific to your vehicle.

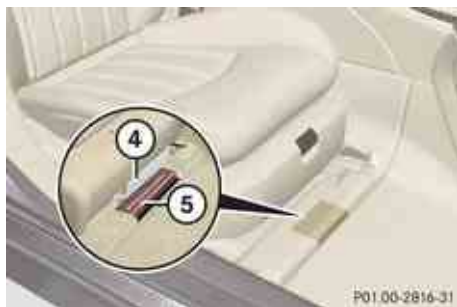

④ Cover

⑤ VIN

- ▶ Move the front passenger seat backward as far as possible (▷ page 96).
- ▶ Fold cover ④ backward. VIN ⑤ is now visible.

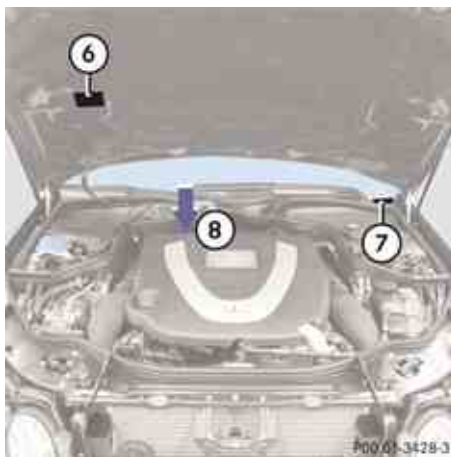

⑥ Emission control information label, includes both federal and California certification exhaust emission standards

⑦ VIN (on lower edge of windshield)

⑧ Engine number (engraved on engine)

**i** When ordering parts, please specify vehicle identification and engine number.

## Engine

Model	E 320 BlueTEC (211.022) <sup>24</sup>	E 300 4MATIC (211.092) <sup>24,25</sup>	E 350 (211.056) <sup>24,26</sup> E 350 4MATIC (211.087, 211.287) <sup>24</sup>
Engine	642	272	272
Mode of operation	Diesel 4-stroke engine	4-stroke engine, gasoline injection	4-stroke engine, gasoline injection
No. of cylinders	6	6	6
Bore	3.27 in (83.00 mm)	3.46 in (88.00 mm)	3.66 in (92.90 mm)
Stroke	3.62 in (92.00 mm)	3.23 in (82.10 mm)	3.39 in (86.00 mm)
Total piston displacement	182.3 cu in (2 987 cm <sup>3</sup> )	182.9 cu in (2 996 cm <sup>3</sup> )	213.5 cu in (3 498 cm <sup>3</sup> )
Compression ratio	16.5:1	11.3:1	10.7:1
Output acc. to SAE J 1349	209 hp/3 400 rpm (156 kW/3 400 rpm)	228 hp/6 000 rpm (170 kW/6 000 rpm) <sup>27</sup>	268 hp/6 000 rpm (200 kW/6 000 rpm) <sup>27</sup>
Maximum torque acc. to SAE J 1349	400 lb-ft/1 600 rpm - 2 400 rpm (543 Nm/1 600 rpm - 2 400 rpm)	221 lb-ft/2 500 rpm - 5 000 rpm (300 Nm/2 500 rpm - 5 000 rpm)	258 lb-ft/2 400 rpm - 5 000 rpm (350 Nm/2 400 rpm - 5 000 rpm)
Maximum engine speed	4 500 rpm	6 500 rpm	6 500 rpm

<sup>24</sup> The quoted data apply only to the standard vehicle. Contact an authorized Mercedes-Benz Center for the corresponding data of all special bodies and special equipment.

<sup>25</sup> Canada only.

<sup>26</sup> USA only.

<sup>27</sup> Premium fuel required. Performance may vary with fuel octane rating.

## Engine

Model	E 320 BlueTEC (211.022) <sup>24</sup>	E 300 4MATIC (211.092) <sup>24,25</sup>	E 350 (211.056) <sup>24,26</sup> E 350 4MATIC (211.087, 211.287) <sup>24</sup>
Firing order	1-4-2-5-3-6	1-4-3-6-2-5	1-4-3-6-2-5
Poly-V-belt	2 035 mm	2 404 mm	2 404 mm



## Engine

Model	E 550 (211.072) <sup>28,29</sup> E 550 4MATIC (211.090) <sup>28</sup>	E 63 AMG (211.077, 211.277 <sup>29</sup> ) <sup>28</sup>
Engine	273	156
Mode of operation	4-stroke engine, gasoline injection	4-stroke engine, gasoline injection
No. of cylinders	8	8
Bore	3.86 in (98.00 mm)	4.02 in (102.20 mm)
Stroke	3.56 in (90.50 mm)	3.72 in (94.60 mm)
Total piston displacement	333.3 cu in (5 461 cm <sup>3</sup> )	378.8 cu in (6 208 cm <sup>3</sup> )
Compression ratio	10.7:1	11.3:1
Output acc. to SAE J 1349	382 hp/6 000 rpm (285 kW/6 000 rpm) <sup>30</sup>	507 hp/6 800 rpm (378 kW/6 800 rpm) <sup>30</sup>
Maximum torque acc. to SAE J 1349	391 lb-ft/2 800 rpm - 4 800 rpm (530 Nm/2 800 rpm - 4 800 rpm)	465 lb-ft/5 200 rpm (630 Nm/5 200 rpm)
Maximum engine speed	6 500 rpm	7 200 rpm
Firing order	1-5-4-2-6-3-7-8	1-5-4-2-6-3-7-8
Poly-V-belt	2 404 mm	2 360 mm

<sup>28</sup> The quoted data apply only to the standard vehicle. Contact an authorized Mercedes-Benz Center for the corresponding data of all special bodies and special equipment.

<sup>29</sup> USA only.

<sup>30</sup> Premium fuel required. Performance may vary with fuel octane rating.

## Rims and tires

### Rims and tires

#### Notes

**!** Only use tires which have been tested and approved by Mercedes-Benz. Tires approved by Mercedes-Benz are developed to provide best possible performance in conjunction with the driving safety systems on your vehicle such as the ABS or the ESP®. Tires specially developed for your vehicle and tested and approved by Mercedes-Benz can be identified by finding the following on the tire's sidewall:

- MO = Mercedes-Benz Original equipment tires

Using tires other than those approved by Mercedes-Benz may result in damage that is not covered by the Mercedes-Benz Limited Warranty.

**!** Using tires other than those approved by Mercedes-Benz can have detrimental effects, such as

- poor handling characteristics
- increased noise
- increased fuel consumption

Moreover, tires and rims not approved by Mercedes-Benz may, under load, exhibit

dimensional variations and different tire deformation characteristics that could cause them to come into contact with the vehicle body or axle parts. Damage to the tires or the vehicle may be the result.

- i** Further information on tires and rims is available at any authorized Mercedes-Benz Center. A placard with the recommended tire inflation pressures is located on the driver's door B-pillar. Some vehicles may have supplemental tire inflation pressure information for driving at high speeds or for vehicle loads less than the maximum loaded vehicle condition. If such information is provided, it can be found on the placard located on the inside of the fuel filler flap. The tire inflation pressure should be checked regularly and should only be adjusted on cold tires. Follow tire manufacturer's maintenance recommendation included with the vehicle.



For information on recommended tire inflation pressure and supplemental tire inflation pressure information for special driving situations, see (▷ page 253).

- i** The following pages also list the approved wheel rim and tire sizes for equipping your vehicles with winter tires. Winter tires are

not available as standard or optional factory equipment, but can be purchased from an authorized Mercedes-Benz Center. Equipping your vehicle with winter tires approved for your vehicle model may require the purchase of two or four wheel rims of the recommended size for use with these winter tires. This depends on vehicle model and the standard or optional factory-equipped wheel rim/tire configuration on your vehicle. For more information contact an authorized Mercedes-Benz Center.

Same size tires

Sedan

Model	E 320 BlueTEC	E 350 <sup>31</sup> E 350 4MATIC <sup>31</sup>	E 300 4MATIC <sup>32</sup>
Rims (light alloy)	8 J x 16 H2	8.5 J x 17 H2	8.5 J x 18 H2
Wheel offset	1.42 in (36 mm)	1.5 in (38 mm)	1.5 in (38 mm)
All season tires <sup>33</sup>	225/55 R16 95H M+S	245/45 R17 95H M+S	245/40 R18 93V M+S
Winter tires <sup>33,34</sup>	225/55 R16 95H M+S 	245/45 R17 99V XL (Extra Load) M+S 	245/40 R18 97V XL (Extra Load) M+S 



<sup>31</sup> USA only.

<sup>32</sup> Canada only.

<sup>33</sup> Radial-ply tires.

<sup>34</sup> Not available as factory equipment.

## Rims and tires

Model	E 350 (AMG Sport Package) <sup>35</sup> E 550 <sup>35</sup> E 63 AMG E 63 AMG (Performance Package)	E 350 4MATIC <sup>36</sup> E 350 4MATIC (AMG Sport Package) <sup>35</sup> E 550 4MATIC
AMG rims (light alloy)	8.5 J x 18 H2	8.5 J x 18 H2
Wheel offset	1.5 in (38 mm)	1.5 in (38 mm)
All-season tires <sup>37</sup>	—	245/40 R18 93V M+S
Winter tires <sup>37,38</sup>	245/40 R18 97V XL (Extra Load) M+S 	245/40 R18 97V XL (Extra Load) M+S 



<sup>35</sup> USA only.

<sup>36</sup> Canada only.

<sup>37</sup> Radial-ply tires.

<sup>38</sup> Not available as factory equipment.

Wagon

Model	E 350 4MATIC	E 63 AMG <sup>39</sup>
Rims (light alloy)	8 J x 17 H2	–
AMG rims (light alloy)	–	8.5 J x 18 H2
Wheel offset	1.5 in (38 mm)	1.5 in (38 mm)
All-season tires <sup>40</sup>	245/45 R17 95H M+S	–
Winter tires <sup>40,41</sup>	245/45 R17 99V XL (Extra Load) M+S 	245/40 R18 97V XL (Extra Load) M+S  <sup>42</sup>

<sup>39</sup> USA only.

<sup>40</sup> Radial-ply tires.

<sup>41</sup> Not available as factory equipment.

<sup>42</sup> Permissible vehicle speed of max. 137 mph (220 km/h).

## Rims and tires

### Mixed size tires

	Model	E 350 (AMG Sport Package) <sup>43</sup> E 550 <sup>43</sup>	E 63 AMG	E 63 AMG (Performance Package)
Front axle	AMG rims (light alloy)	8.5 J x 18 H2	8.5 J x 18 H2	8.5 J x 18 H2
	Wheel offset	1.5 in (38 mm)	1.5 in (38 mm)	1.5 in (38 mm)
	Summer tires <sup>44</sup>	—	245/40 ZR18	245/40 ZR18
	All-season tires <sup>44</sup>	245/40 R18 93V M+S	—	—
Rear axle	AMG rims (light alloy)	9 J x 18 H2	9 J x 18 H2	9.5 J x 18 H2
	Wheel offset	1.54 in (39 mm)	1.54 in (39 mm)	1.73 in (44 mm)
	Summer tires <sup>44,45</sup>	—	265/35 ZR18 XL (Extra Load)	265/35 ZR18 XL (Extra Load)
	All-season tires <sup>44,45</sup>	265/35 R18 97V XL (Extra Load) M+S	—	—

<sup>43</sup> USA only.

<sup>44</sup> Radial-ply tires.

<sup>45</sup> Must not be used with snow chains.

**Spare wheel**

**!** Compare the recommended tire inflation pressure for your vehicle with the tire inflation pressure on the yellow label located on the spare wheel rim.

If the tire inflation pressure on the yellow label on the spare wheel rim differs from the values given in this Operator’s Manual, inflate the tire to the recommended tire inflation pressure given on the yellow label on the spare wheel rim.

**i** Please note that the tire inflation pressure of the spare wheel differs from the tire inflation pressure of the road tires.

**i** The E 63 AMG wagon with folding third-row seat does not have a spare wheel. It is equipped with TIREFIT (▷ page 355).

Model	All (except E 63 AMG)	E 63 AMG
Rim	4 B x 17	6 B x 18
Wheel offset	1.34 in (34 mm)	0.98 in (25 mm)
Minispare tire <sup>46</sup>	T 155/70 R17 110 M	–
Collapsible tire <sup>46</sup>	–	175/55-18 95P
Recommended tire inflation pressure	61 psi (4.2 bar)	51 psi (3.5 bar)

<sup>46</sup> Must not be used with snow chains.

## Electrical system

### Electrical system

Model		E 320 BlueTEC	E 300 4MATIC <sup>47</sup>	E 350 (all models)	E 550 (all models)	E 63 AMG
Alternator		14 V/180 A	14 V/180 A	14 V/180 A	14 V/180 A	14 V/180 A
Starter motor		12 V/2.0 kW	12 V/1.7 kW	12 V/1.4 kW	12 V/1.7 kW	12 V/2.1 kW
Battery		12 V/100 Ah	12 V/100 Ah	12 V/100 Ah	12 V/100 Ah	12 V/95 Ah
Spark plugs	Type	—	Bosch Platin Y 7 MPP33	Bosch Platin Y 7 MPP33 NGK PLKR 6A	Bosch F8 DPP 332U NGK PFR 5R-11	NGK ILZKAR 7A10
	Electrode gap	—	0.031 in (0.8 mm)	0.031 in (0.8 mm)	0.039 in (1.0 mm)	0.039 in (1.0 mm)
	Tightening torque	—	15 lb-ft - 18 lb-ft (20 Nm - 25 Nm)	15 lb-ft - 22 lb-ft (20 Nm - 30 Nm)	18 lb-ft - 22 lb-ft (25 Nm - 30 Nm)	15 lb-ft - 18 lb-ft (20 Nm - 25 Nm)

<sup>47</sup> Canada only.



Main dimensions

Model		E 320 BlueTEC	E 300 4MATIC <sup>48</sup>	E 350 <sup>49</sup>	E 350 4MATIC
Overall vehicle length	Sedan	191.0 in (4 852 mm)	191.0 in (4 852 mm)	191.0 in (4 852 mm)	191.0 in (4 852 mm)
	Wagon	—	—	—	192.3 in (4 884 mm)
Overall vehicle width		81.2 in (2 063 mm)	81.2 in (2 063 mm)	81.2 in (2 063 mm)	81.2 in (2 063 mm)
Overall vehicle height	Sedan	58.4 in (1 484 mm)	59.0 in (1 498 mm)	58.4 in (1 484 mm)	59.0 in (1 499 mm)
	Wagon	—	—	—	59.4 in (1 509 mm)
Wheelbase		112.4 in (2 854 mm)	112.4 in (2 854 mm)	112.4 in (2 854 mm)	112.4 in (2 854 mm)
Track, front		61.3 in (1 557 mm)	61.6 in (1 565 mm)	61.7 in (1 567 mm)	61.6 in (1 565 mm)
Track, rear		61.1 in (1 552 mm)	61.4 in (1 560 mm)	61.4 in (1 560 mm)	61.4 in (1 560 mm)

<sup>48</sup> Canada only.

<sup>49</sup> USA only.

## Main dimensions

Model		E 550 <sup>50</sup>	E 550 4MATIC	E 63 AMG
Overall vehicle length	Sedan	191.0 in (4 852 mm)	191.0 in (4 852 mm)	192.2 in (4 881 mm)
	Wagon <sup>50</sup>	—	—	193.7 in (4 919 mm)
Overall vehicle width		81.2 in (2 063 mm)	81.2 in (2 063 mm)	81.2 in (2 063 mm)
Overall vehicle height	Sedan	57.7 in (1 465 mm)	58.1 in (1 475 mm)	56.3 in (1 431 mm)
	Wagon <sup>50</sup>	—	—	58.5 in (1 485 mm)
Wheelbase		112.4 in (2 854 mm)	112.4 in (2 854 mm)	112.4 in (2 854 mm)
Track, front		61.7 in (1 567 mm)	61.6 in (1 565 mm)	61.1 in (1 551 mm)
Track, rear		61.4 in (1 560 mm)	61.4 in (1 560 mm)	61.4 in (1 560 mm)

<sup>50</sup> USA only.

## Weights

Model	All models
Roof load	max. 220 lb (100 kg)

## Fuels, coolants, lubricants etc.

### Fuels, coolants, lubricants etc.

#### Capacities

Vehicle components and their respective lubricants must match. Therefore only use products tested and approved by Mercedes-Benz.

For information on tested and approved products, contact an authorized Mercedes-Benz Center or visit [www.mbusa.com](http://www.mbusa.com) (USA only).

#### **Warning!**

Comply with all valid regulations with respect to handling, storing, and disposing of service fluids. Otherwise you could endanger persons or the environment. Keep service fluids out of the reach of children.

For health reasons, you should prevent service fluids from coming into direct contact with your skin or clothing.

If a service fluid is swallowed, contact a physician immediately.

	Model	Capacity	Fuels, coolants, lubricants, etc.
Engine with oil filter	E 350 (all models)	8.5 US qt (8.0 l)	Approved engine oils
	E 320 BlueTEC	9.0 US qt (8.5 l)	
	E 300 4MATIC <sup>51</sup>		
	E 550 (all models)		
	E 63 AMG <sup>52</sup>	9.3 US qt (8.8 l)	

<sup>51</sup> Canada only.

<sup>52</sup> Engine with oil cooler.

Fuels, coolants, lubricants etc.

	Model	Capacity	Fuels, coolants, lubricants, etc.
<b>Automatic transmission</b>	E 320 BlueTEC E 350 <sup>53</sup> E 550 <sup>53</sup>	9.7 US qt (9.2 l)	MB Automatic Transmission Fluid
	E 300 4MATIC <sup>51</sup> E 350 4MATIC E 550 4MATIC	8.6 US qt (8.1 l)	
	E 63 AMG <sup>54</sup>	9.3 US qt (8.8 l)	
<b>Front axle</b>	E 300 4MATIC <sup>51</sup> E 350 4MATIC E 550 4MATIC	1.7 US qt (1.6 l)	Hypoid gear oil SAE 85 W 90
<b>Rear axle</b>	E 300 4MATIC <sup>51</sup> E 350 4MATIC E 550 4MATIC	1.7 US qt (1.6 l)	Hypoid gear oil SAE 85 W 90
	E 320 BlueTEC E 550 <sup>53</sup>	1.4 US qt (1.3 l)	
	E 350 <sup>53</sup>	1.1 US qt (1.0 l)	
	E 63 AMG	1.3 US qt (1.2 l)	Fuchs Titan EG 5010 D

<sup>53</sup> USA only.

<sup>51</sup> Canada only.

<sup>54</sup> Automatic transmission with oil cooler.



## Fuels, coolants, lubricants etc.

	Model	Capacity	Fuels, coolants, lubricants, etc.
<b>Transfer case</b>	E 300 4MATIC <sup>51</sup>	0.62 US qt (0.59 l)	MB Transfer Case Fluid
	E 350 4MATIC		
	E 550 4MATIC		
<b>Power steering</b>	All models except E 63 AMG	approx. 1.0 US qt (0.9 l)	MB Power Steering Fluid (Chevron Texaco PSF 9109)
	E 63 AMG	approx. 1.3 US qt (1.2 l)	
<b>Brake system</b>		0.63 US qt (0.6 l)	MB Brake Fluid (DOT 4+)
<b>Cooling system</b>	E 320 BlueTEC	approx. 13.7 US qt (13.0 l)	MB 325.0 Anticorrosion/Antifreeze
	E 300 4MATIC <sup>51</sup> E 350 (all models)	approx. 10.7 US qt (10.0 l)	
	E 550 (all models)	approx. 11.9 US qt (11.3 l)	
	E 63 AMG	approx. 12.5 US qt (11.8 l)	
<b>Fuel tank, including a reserve of</b>		21.1 US gal (80.0 l)	Gasoline engine: Premium unleaded gasoline (Minimum Posted Octane 91 [Avg. of 96 RON/86 MON])  Diesel engine: ULTRA-LOW SULFUR HIGHWAY DIESEL FUEL (15 ppm SULFUR MAXIMUM)
	All models except E 63 AMG	2.4 US gal (9.0 l)	
	E 63 AMG	3.7 US gal (14.0 l)	
<b>Air conditioning system</b>		—	R134a refrigerant and special PAG lubricant oil (never R 12)

<sup>51</sup> Canada only.

## Fuels, coolants, lubricants etc.

	Model	Capacity	Fuels, coolants, lubricants, etc.
Washer system		4.8 US qt (4.5 l)	MB Windshield Washer Concentrate <sup>55</sup> (▷ page 402) Washer fluid mixing ratio (▷ page 402)
Washer system and headlamp cleaning system		6.9 US qt (6.5 l)	

## Approved engine oils

Engine oils are specifically tested for their suitability in our engines and durability for our service intervals. Therefore, only use approved engine oils and oil filters required for vehicles with Maintenance System.

For a listing of approved engine oils and oil filters, contact an authorized Mercedes-Benz Center or visit [www.mbusa.com](http://www.mbusa.com) (USA only).

**!** Using engine oils and oil filters of a specification other than those expressly required for the Maintenance System, or changing of oil and oil filter at change intervals longer than those called for by the Maintenance System will result in engine or emission control system damage not

covered by the Mercedes-Benz Limited Warranty.

Please follow Maintenance System recommendations for scheduled oil changes. Failure to do so will result in engine or emission control system damage not covered by the Mercedes-Benz Limited Warranty.

Mercedes-Benz recommends MOBIL OIL.

Use the table below to determine the MB sheet number.

Model	Engine type	MB sheet number
E 320 BlueTEC	642	229.5 1
E 300 4MATIC <sup>56</sup>	272	229.5

Model	Engine type	MB sheet number
E 350 <sup>57</sup>	272	229.5
E 350 4MATIC	272	229.5
E 550 <sup>57</sup>	273	229.5
E 550 4MATIC	273	229.5
E 63 AMG	156	229.5 <sup>58</sup>

**i** MB sheet numbers are printed on the outside of oil containers.

<sup>55</sup> Mixed with water or commercially available premixed washer solvent/antifreeze.

<sup>56</sup> Canada only.

<sup>57</sup> USA only.

<sup>58</sup> Restriction: Only SAE 0W-40/SAE 5W-40 engine oils may be used.

### Fuels, coolants, lubricants etc.

#### Viscosity grades for engine oils

Using the chart below, select oil viscosity according to the lowest air temperature expected before the next oil change.

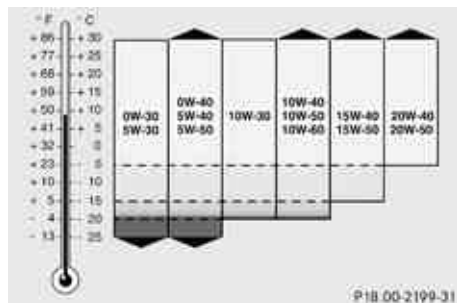

#### Engine oil additives

**!** Do not blend oil additives with engine oil. They may damage the engine. Damage or malfunctions resulting from blending oil additives are not covered by the Mercedes-Benz Limited Warranty.

#### Air conditioning refrigerant

R134a (HFC) refrigerant and special PAG lubricating oil are used in the air conditioning system.

**!** Never use R 12 (CFC) or mineral-based lubricating oil. Otherwise damage to the system will occur.

#### Brake fluid

##### **⚠ Warning!**

During vehicle operation, the boiling point of the brake fluid is continuously reduced through the absorption of moisture from the atmosphere.

Under extremely strenuous operating conditions, this moisture content can lead to the formation of bubbles in the system, thus reducing the system's efficiency.

Therefore, the brake fluid must be replaced regularly. Refer to your vehicle's Maintenance Booklet for replacement interval.

Only brake fluid approved by Mercedes-Benz is recommended. Any authorized Mercedes-

Benz Center will provide you with additional information.

#### Premium unleaded gasoline (gasoline engine)

##### **⚠ Warning!**

Gasoline is highly flammable and poisonous. It burns violently and can cause serious personal injury.

Never allow sparks, flames or smoking materials near gasoline!

Turn off the engine before refueling.

Whenever you are around gasoline, avoid inhaling fumes and any skin or clothing contact. Extinguish all smoking materials.

Direct skin contact with fuels and the inhalation of fuel vapors are damaging your health.

**!** To maintain the engine's durability and performance, premium unleaded gasoline must be used.

If premium unleaded gasoline is not available and low octane gasoline is used, follow these precautions:

- Have the fuel tank only partially filled with unleaded regular gasoline and fill up



**Fuels, coolants, lubricants etc.**

with premium unleaded gasoline as soon as possible.

- Avoid full throttle driving and abrupt acceleration.
- Do not exceed an engine speed of 3 000 rpm if the vehicle is loaded with a light load such as two persons and no luggage.
- Do not exceed  $\frac{2}{3}$  of maximum accelerator pedal position if the vehicle is fully loaded or operating in mountainous terrain.

**Fuel requirements**

**Gasoline engine**

Only use premium unleaded gasoline. The octane number (posted at the pump) must be 91 min. It is an average of both the Research Octane Number (RON) and the Motor Octane Number (MON):  $(RON+MON)/2$ . This is also known as the ANTI-KNOCK INDEX.

Reformulated gasolines (RFG) and/or unleaded gasoline containing oxygenates such as ethanol, TAME, ETBE, IPA, IBA, and TBA can be used provided the ratio of any one of these oxygenates to gasoline does not exceed 10%; MTBE must not exceed 15%.

The ratio of methanol to gasoline must not exceed 3% plus additional cosolvents.

Using mixtures of ethanol and methanol is not allowed. Gasohol, which contains 10% ethanol and 90% unleaded gasoline, can be used.

These blends must also meet all other fuel requirements, such as resistance to spark knock, boiling range, vapor pressure, etc.

**Diesel engine**

Only use commercially available vehicular ULTRA-LOW SULFUR HIGHWAY DIESEL FUEL (15 ppm SULFUR MAXIMUM) that meets the ASTM D975 standard. Failure to use ULTRA-LOW SULFUR HIGHWAY DIESEL FUEL can severely damage the vehicle's exhaust after-treatment device.

To prevent malfunctions, diesel fuel with improved cold flow characteristics is offered in the winter months. Check with your fuel retailer.

- ❗ Do not fill the tank with gasoline. Do not blend diesel fuel with gasoline or kerosene. The fuel system and engine will otherwise be damaged, which is not covered by the Mercedes-Benz Limited Warranty.

For further information on diesel fuel pump labeling, contact an authorized Mercedes-Benz Center or visit [www.mbusa.com](http://www.mbusa.com) (USA only).

**B5 biodiesel**

Mercedes-Benz USA, LLC approves the use of B5 biodiesel (standard diesel with a maximum of up to 5% biodiesel content) in all Common Rail Injection (CDI) and BlueTEC diesel engines. Diesel fuels containing a higher percentage of biodiesel content will cause damage to your engine and are not approved.

Biodiesel can be refined from a variety of raw materials which may result in widely varying properties. Only use approved biodiesel.

Approved biodiesel meets the ASTM D6751 standard and has the necessary oxidation stability (minimum 6 hours, proved with EN14112 method) to prevent deposits and/or corrosion. The use of non-approved biodiesel may damage the fuel system.

Please ask your service station for further information. If the B5 biodiesel blend is not sufficiently labeled to clearly indicate that it meets the above standards, please do not use it. The Mercedes-Benz Limited Warranty does not cover damage caused by the use of fuels



### Fuels, coolants, lubricants etc.

not meeting Mercedes-Benz approved fuel standards.

#### Gasoline additives (gasoline engine)

A major concern among engine manufacturers is carbon build-up caused by gasoline. Mercedes-Benz recommends only the use of quality gasoline containing additives that prevent the build-up of carbon deposits.

After an extended period of using fuels without such additives carbon deposits can build up, especially on the intake valves and in the combustion area, leading to engine performance problems such as:

- Warm-up hesitation
- Unstable idle
- Knocking/pinging
- Misfire
- Power loss

In areas where carbon deposits may be encountered due to lack of availability of gasoline which contains these additives, Mercedes-Benz recommends the use of additives approved by us for use on Mercedes-Benz vehicles.

Contact an authorized Mercedes-Benz Center or visit [www.mbusa.com](http://www.mbusa.com) (USA only) for a listing of approved product(s). Follow directions on product label.

Do not blend other fuel additives with fuel.

This only results in unnecessary cost and may be harmful to the engine operation.

**!** Damage or malfunction resulting from poor fuel quality or from blending additional fuel additives other than those tested and approved by us for use on Mercedes-Benz vehicles are not covered by the Mercedes-Benz Limited Warranty or by any pre-owned or Extended Limited warranties.

#### Coolants

The engine coolant is a mixture of water and anticorrosion/antifreeze, which provides:

- Corrosion protection
- Freeze protection
- Boiling protection (by increasing the boiling point)

The cooling system was filled at the factory with a coolant providing freeze protection to approximately -35°F (-37°C) and corrosion protection.

**!** Add premixed coolant solution only. Adding water and MB 325.0 Anticorrosion/Antifreeze separately from each other, could cause engine damage not covered by the Mercedes-Benz Limited Warranty.

If the antifreeze mixture is effective to -35°F (-37°C), the boiling point of the coolant in the pressurized cooling system is reached at approximately 266°F (130°C).

The coolant solution must be used year round to provide the necessary corrosion protection and increase boil-over protection. Refer to the Maintenance Booklet for replacement interval.

Coolant system design and coolant used determine the replacement interval. The replacement interval published in the Maintenance Booklet is only applicable if MB 325.0 Anticorrosion/Antifreeze solution or other Mercedes-Benz approved products of equal specification are used to renew the coolant concentration or bring it back up to the proper level.

For information on other Mercedes-Benz approved products of equal specification, contact an authorized Mercedes-Benz Center or visit [www.mbusa.com](http://www.mbusa.com) (USA only).

To provide important corrosion protection, the solution must be at least 50%

**Fuels, coolants, lubricants etc.**

anticorrosion/antifreeze (equivalent to freeze protection to approximately -35°F [-37°C]).

If you use a solution that is more than 55% anticorrosion/antifreeze (freeze protection to approximately -49°F [-45°C]), the engine temperature will increase due to the lower heat transfer capability of the solution.

Therefore, do not use more than this amount of anticorrosion/antifreeze.

If the coolant level is low, water and MB 325.0 Anticorrosion/Antifreeze should be used to bring it up to the proper level (have cooling system checked for signs of leakage). Please make sure the mixture is in accordance with label instructions.

The water in the cooling system must meet minimum requirements, which are usually satisfied by normal drinking water.

If you are not sure about the water quality, contact an authorized Mercedes-Benz Center.

**Anticorrosion/antifreeze**

Your vehicle contains a number of aluminum parts. The use of aluminum components in motor vehicle engines necessitates that anticorrosion/antifreeze coolant used in such engines be specifically formulated to protect the aluminum parts. Failure to use

such anticorrosion/antifreeze coolant will result in a significantly shortened service life.

Therefore, the following product is strongly recommended for use in your vehicle: MB 325.0 Anticorrosion/Antifreeze agent.

Before the start of the winter season (or once a year in hot southern regions), you should have the anticorrosion/antifreeze concentration checked.

The coolant is also regularly checked each time you bring your vehicle to an authorized Mercedes-Benz Center for service.

	Model	Approximate freeze protection	
		-35°F (-37°C)	-49°F (-45°C)
<b>Cooling system</b>	E 320 BlueTEC	6.9 US qt (6.5 l)	7.6 US qt (7.2 l)
	E 300 4MATIC <sup>59</sup> E 350 (all models)	5.3 US qt (5.0 l)	5.9 US qt (5.5 l)
	E 550 (all models)	6.0 US qt (5.7 l)	6.6 US qt (6.2 l)
	E 63 AMG	6.2 US qt (5.9 l)	6.9 US qt (6.5 l)

<sup>59</sup> Canada only.

### Fuels, coolants, lubricants etc.

#### Washer system and headlamp cleaning system

##### **Warning!**

Washer solvent/antifreeze is highly flammable. Do not spill washer solvent/antifreeze on hot engine parts, because it may ignite and burn. You could be seriously burned.

- ▶ Use MB Windshield Washer Concentrate “MB SummerFit”.
- ▶ Mix with water for temperatures above freezing point.
- ▶ Mix with commercially available premixed washer solvent/antifreeze for temperatures below freezing point.

#### Washer fluid mixing ratio

---

For temperatures above freezing point:

1 part “MB SummerFit” to 100 parts water  
(1.34 fl oz [40 ml] “MB SummerFit” to 1 gal [4.0 l] water)

For temperatures below freezing point:

1 part “MB SummerFit” to 100 parts solvent  
(1.34 fl oz [40 ml] “MB SummerFit” to 1 gal [4.0 l] solvent)





## Service and Literature

Your authorized Mercedes-Benz Center has trained technicians and Genuine Mercedes-Benz Parts to service your vehicle properly. For expert advice and quality service, contact an authorized Mercedes-Benz Center.

If you are interested in obtaining service literature for your vehicle, please contact an authorized Mercedes-Benz Center.

We consider this the best way for you to obtain accurate information for your vehicle.

For further information you can find us on the Mercedes-Benz web-site **www.mbusa.com** (USA only) or **www.mercedes-benz.ca** (Canada only).

### **Warning!**

To help avoid personal injury, be extremely careful when performing any service work or repairs. Improper or incomplete service or the use of incorrect or inappropriate parts or materials may damage the vehicle or its equipment, which may in turn result in personal injury.

If you have any questions about carrying out any type of service, turn to the advice of an authorized Mercedes-Benz Center.

Therefore, information, illustrations and descriptions in this Operator's Manual might differ from your vehicle.

Reprinting, translation and copying, even of excerpts, is not permitted without our prior authorization in writing.

Press time May 28, 2008

GSP/OIS

Printed in U. S. A.

We reserve the right to make changes in design and equipment.



2115848697

Order no. 6515 3416 13 Part no. 211 584 86 97 Edition A 2009