

# Foreword

Welcome to the growing family of new NISSAN owners. This vehicle is delivered to you with confidence. It was produced using the latest techniques and strict quality control.

This manual was prepared to help you understand the operation and maintenance of your vehicle so that you may enjoy many miles of driving pleasure. Please read through this manual before operating your vehicle.

**A separate Warranty Information and Maintenance Log Booklet explains details about the warranties covering your vehicle and vehicle maintenance schedules. Additionally, a separate Customer Care/Lemon Law Booklet will explain how to resolve any concerns you may have with your vehicle, as well as clarify your rights under your state's lemon law.**

Your NISSAN dealership knows your vehicle best. When you require any service or have any questions, they will be glad to assist you with the extensive resources available to them.

## READ FIRST — THEN DRIVE SAFELY

Before driving your vehicle read this owner's manual carefully. This will ensure familiarity with controls and maintenance requirements, assisting you in the safe operation of your vehicle.

### WARNING

#### **IMPORTANT SAFETY INFORMATION REMINDERS FOR SAFETY!**

**Follow these important driving rules to help ensure a safe and complete trip for you and your passengers:**

- **NEVER** drive under the influence of alcohol or drugs.
- **ALWAYS** observe posted speed limits and never drive too fast for conditions.
- **ALWAYS** use your seat belts and appropriate child restraint systems. Pre-teen children should be seated in the rear seat.
- **ALWAYS** provide information about the proper use of vehicle safety features to all occupants of the vehicle.
- **ALWAYS** review this Owner's Manual for important safety information.

The inside pages of this manual contain a minimum of 50% recycled fibers, including 10% post-consumer fibers.



### **MODIFICATION OF YOUR VEHICLE**

**This vehicle should not be modified. Modification could affect its performance, safety or durability, and may even violate governmental regulations. In addition, damage or performance problems resulting from modifications may not be covered under NISSAN warranties.**

### WHEN READING THE MANUAL

This manual includes information for all options available on this model. Therefore, you may find some information that does not apply to your vehicle.

All information, specifications and illustrations in this manual are those in effect at the time of printing. NISSAN reserves the right to change specifications or design without notice and without obligation.

## IMPORTANT INFORMATION ABOUT THIS MANUAL

You will see various symbols in this manual. They are used in the following ways:

### WARNING

This is used to indicate the presence of a hazard that could cause death or serious personal injury. To avoid or reduce the risk, the procedures must be followed precisely.

### CAUTION

This is used to indicate the presence of a hazard that could cause minor or moderate personal injury or damage to your vehicle. To avoid or reduce the risk, the procedures must be followed carefully.

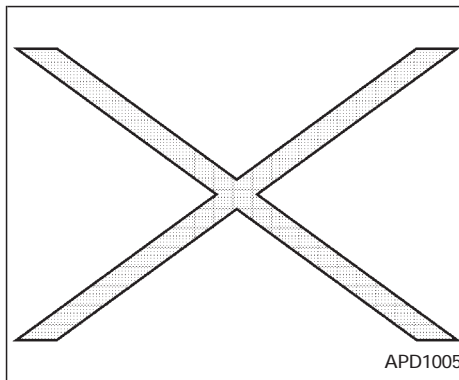

If you see this symbol, it means “Do not do this” or “Do not let this happen.”

The inside pages of this manual contain a minimum of 50% recycled fibers, including 10% post-consumer fibers.



© 1998 NISSAN NORTH AMERICA, INC.  
GARDENA, CALIFORNIA

All rights reserved. No part of this Owner's Manual may be reproduced or stored in a retrieval system, or transmitted in any form, or by any means, electronic, mechanical, photocopying, recording or otherwise, without the prior written permission of Nissan North America, Inc., Gardena, California

# Welcome To The World Of NISSAN

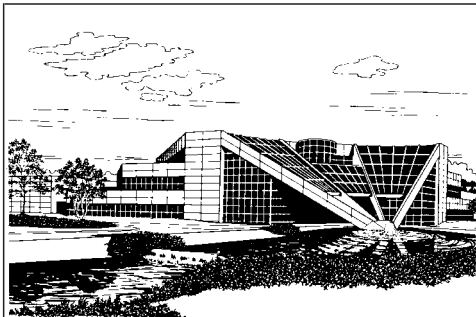

NISSAN RESEARCH & DEVELOPMENT, INC.  
in Farmington Hills, Michigan

Your new NISSAN is the result of our dedication to produce the finest in safe, reliable and economical transportation. Your vehicle is the product of a successful worldwide company that manufactures cars and trucks in over 17 countries and distributes them in 170 nations.

NISSAN vehicles are designed and manufactured by Nissan Motor Co., Ltd. which was founded in Tokyo, Japan in 1933, and NISSAN affiliates worldwide, collectively growing to become the fifth largest automaker in the world. In addition to cars and trucks, NISSAN also makes textile machinery, forklift trucks, marine engines, boats and other products.

NISSAN has made a substantial and growing investment in North America, starting with the opening of Nissan Motor Corporation U.S.A. in 1960 and continuing with the production of some cars and trucks at one of the world's most modern manufacturing facilities, Nissan Motor

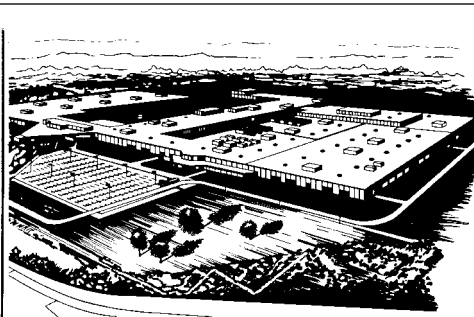

NISSAN MOTOR MANUFACTURING CORPORATION  
U.S.A. in Smyrna, Tennessee  
AFW0001

Manufacturing Corporation U.S.A. in Smyrna, Tennessee, vehicle styling at Nissan Design International in San Diego, California, and engineering at Nissan Research and Development in Farmington Hills, Michigan.

NISSAN and its dealers employ about 60,000 Americans.

NISSAN is also a substantial contributor to the Canadian economy. Nissan Canada Inc., its suppliers and over 150 dealers employ approximately 4,500 people. These include company employees and the staffs of NISSAN dealers all across Canada. In addition, many Canadians work for companies that supply NISSAN and NISSAN dealers with materials and services ranging from the operation of port facilities and transportation services, to the supply of lubricants, parts and accessories.

NISSAN pioneered the use of electronics and computers in automobiles, and has led the industry in improving both performance and fuel efficiency through new engine designs and the use of synthetic materials to reduce vehicle weight. The company has also developed ways to build quality into its vehicles at each stage of the production process, both through extensive use of automation and — most importantly — through an awareness that **people** are the central element in quality control.

From the time the parts arrived from our suppliers until you took delivery of your new NISSAN, dozens of checks were made to ensure that only the best job was being done in producing and delivering your vehicle. NISSAN also takes great care to ensure that when you take your NISSAN to your dealer for maintenance, the service technician will perform his work according to the quality standards that have been established by the factory.

Safety has also been built into your NISSAN. As you know, seat belts are an integral part of the safety systems that will help protect you and your passengers in the event of a sudden stop or an accident. We urge you to use the seat belts every time you drive the vehicle.

The NISSAN story of growth and achievement reflects our major goal: to provide you, our customer, with a vehicle that is built with quality and craftsmanship — a product that we can be proud to build and you can be proud to own.

# NISSAN CUSTOMER CARE PROGRAM

## NISSAN CARES ...

Both NISSAN and your NISSAN dealer are dedicated to serving all your automotive needs. Your satisfaction with your vehicle and your NISSAN dealer are our primary concerns. Your NISSAN dealer is always available to assist you with all your automobile sales and service needs.

However, if there is something that your NISSAN dealer cannot assist you with or you would like to provide NISSAN directly with comments or questions, please contact our (NISSAN's) Consumer Affairs Department using our toll-free number:

### **For U.S. mainland and Alaska customers**

**1-800-NISSAN-1  
(1-800-647-7261)**

### **For Hawaii customers**

**(808) 836-0888 (Oahu Number)**

### **For Canada customers**

**1-800-387-0122**

The Consumer Affairs Department will ask for the following information:

- Your name, address, and telephone number
- Vehicle identification number (on dashboard)
- Date of purchase
- Current odometer reading
- Your NISSAN dealer's name
- Your comments or questions

### **OR**

you may write to NISSAN with the information

on the left at:

### **For U.S. mainland and Alaska customers**

**Nissan North America, Inc.  
Consumer Affairs Department  
P.O. Box 191  
Gardena, California 90248-0191**

### **For Hawaii customers**

**Nissan Motor Corporation in Hawaii  
2880 Kilihau St.  
Honolulu, Hawaii 96819**

### **For Canada customers**

**Nissan Canada Inc.  
5290 Orbitor Drive  
Mississauga, Ontario L4W 4Z5**

We appreciate your interest in NISSAN and thank you for buying a quality NISSAN vehicle.



# Table of Contents

Seats, restraints and supplemental air bag systems	1
Instruments and controls	2
Pre-driving checks and adjustments	3
Heater, air conditioner and audio systems	4
Starting and driving	5
In case of emergency	6
Appearance and care	7
Do-it-yourself	8
Maintenance	9
Technical and consumer information	10
Index	11

# 1 Seats, restraints and supplemental air bag systems

Seats .....	1-2	Three passenger bench seat in the second row position .....	1-35
Manual front seat adjustment.....	1-3	Three-passenger bench seat .....	1-37
Power front seat adjustment (if so equipped).....	1-4	Two-point type without retractor (center of three-passenger bench seat) .....	1-38
Head restraints .....	1-6	Seat belt extenders .....	1-40
Armrests .....	1-6	Seat belt maintenance .....	1-40
Underseat storage tray (if so equipped) .....	1-7	Child restraints .....	1-41
Tabletop seats.....	1-7	Front facing installation at three-passenger bench seat center position .....	1-43
Flexible seating .....	1-8	Rear facing installation at three-passenger bench seat center position .....	1-44
Sliding three-passenger seat .....	1-15	Front facing installation at second and third row outboard positions .....	1-45
Supplemental restraint system (supplemental air bag system).....	1-19	Rear facing installation at second and third row outboard positions .....	1-48
Supplemental air bag system.....	1-22	Child restraint with top tether strap.....	1-51
Warning labels.....	1-24	Installation on second row bench or bucket seat.....	1-52
Supplemental air bag warning light.....	1-24	Installation on three-passenger bench seat in second row .....	1-54
Seat belts .....	1-26		
Precautions on seat belt usage .....	1-26		
Child safety.....	1-27		
Pregnant women .....	1-28		
Injured persons .....	1-28		
Three-point type with retractor .....	1-29		
Three-point type seat belt with retractor for second row bucket seats .....	1-32		

Installation on three-passenger bench seat in third row.....	1-56
Integrated child safety seats (if so equipped).....	1-61
Seats/floor mats .....	1-68
Seating arrangements .....	1-68
Floor mat positioning.....	1-69
Seven passenger seating .....	1-69
Three-passenger bench seat in storage position .....	1-69

Five passenger seating.....	1-70
Five passenger seating with cargo room.....	1-71
Three-passenger bench seat in fully forward position .....	1-71
Floor mat positioning aid.....	1-72
Seat positions.....	1-73
With second row bench seat.....	1-73
With second row bucket seats .....	1-77





## SEATS

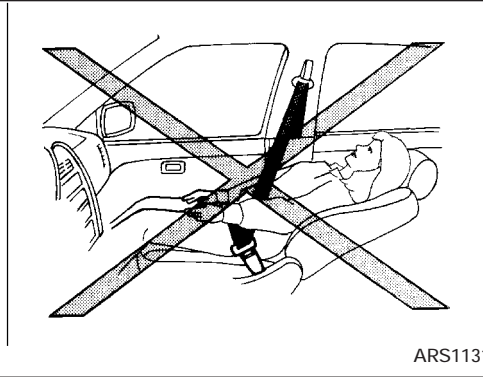
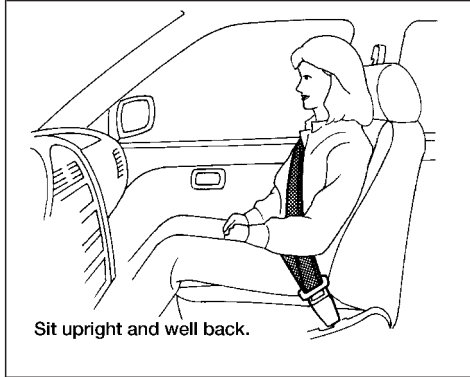

### WARNING

- Do not ride in a moving vehicle when the seatback is reclined. This can be dangerous. The shoulder belt will not be against your body. In an accident you could be thrown into it and receive neck or other serious injuries. You could also slide under the lap belt and receive serious internal injuries.

- For most effective protection when the vehicle is in motion, the seat should be upright. Always sit well back in the seat and adjust the seat belt properly. See "Precautions on Seat Belt Usage" later in this section.

## MANUAL FRONT SEAT ADJUSTMENT

### WARNING

- Do not adjust the driver's seat while driving. The seat may move suddenly and could cause loss of control of the vehicle.
- After adjustment, gently rock in the seat to make sure it is securely locked.

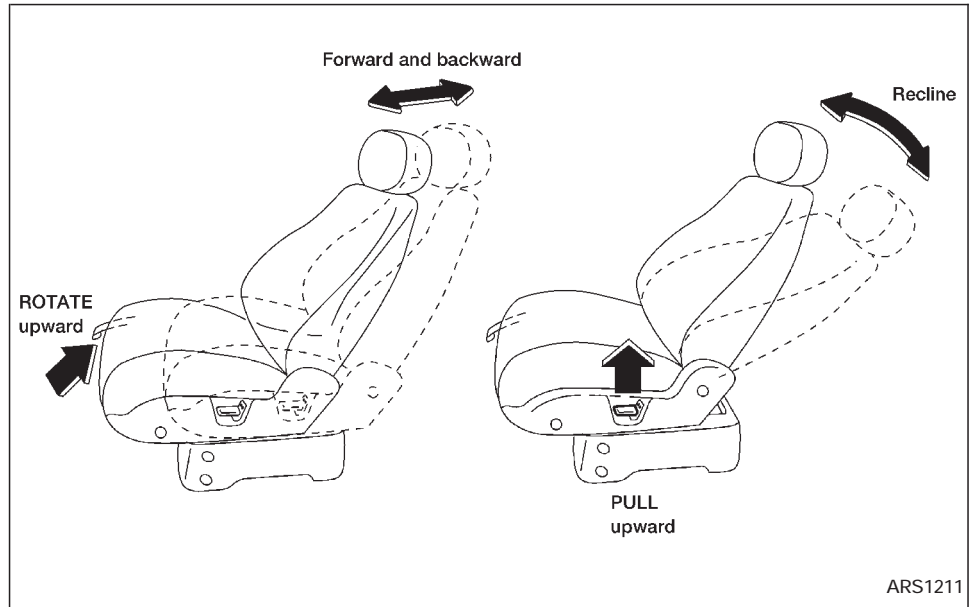

### Forward and backward

Rotate the lever up while you slide the seat forward or backward to the desired position. Release the lever to lock the seat in position.

### Reclining

To recline the seatback, pull the lever up and lean back. To bring the seatback forward again, pull the lever up and move your body forward. The seatback moves forward. Release the lever to lock the seatback in position.

## POWER FRONT SEAT ADJUSTMENT (if so equipped)

### WARNING

- Do not adjust the driver's seat while driving. The seat may move suddenly and could cause loss of control of the vehicle.
- Do not leave children unattended inside the vehicle. They could unknowingly activate switches or controls. Unattended children could become involved in serious accidents.

For memory seat and mirror information see "Memory driver seat and mirrors" in the "Pre-driving checks and adjustments" section.

### Operating tips

- The motor has an auto-reset overload protection circuit. If the motor stops during operation, wait 30 seconds, then reactivate the switch.
- Do not operate the power support seat for a long period of time when the engine is off. This discharges the battery.

## 1-4 Seats, restraints and supplemental air bag systems

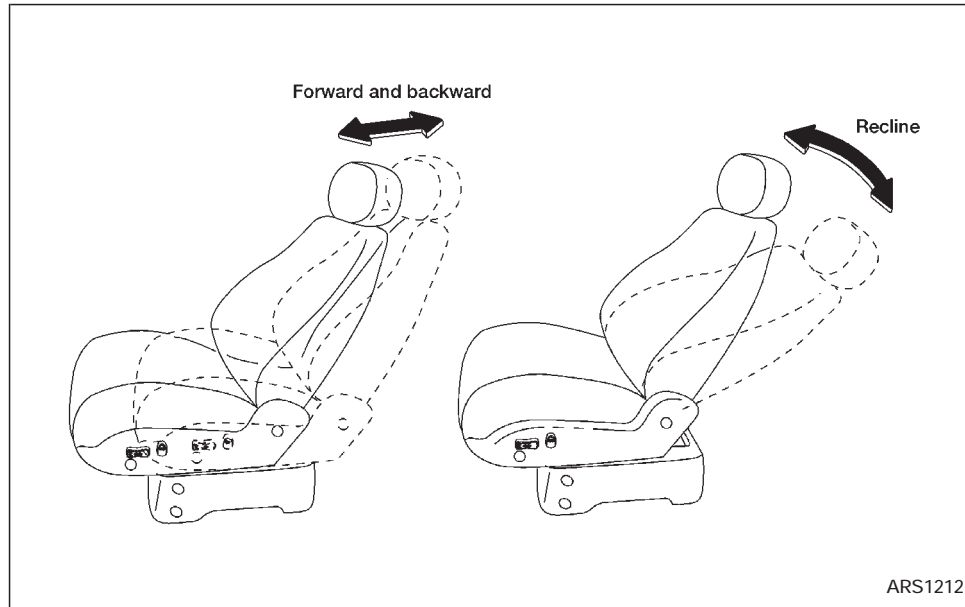

### Forward and backward adjustment

To move the seat forward, push the power slide switch forward. To move the seat backward, push the power slide switch backward. Release the switch to stop the movement of the seat.

### Reclining

To recline the seat back, push the power recliner switch backward. To return to a more upright position, push the power recliner switch forward. Release the switch to stop the movement of the seatback.

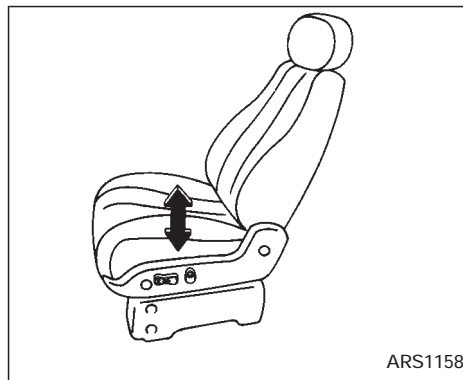
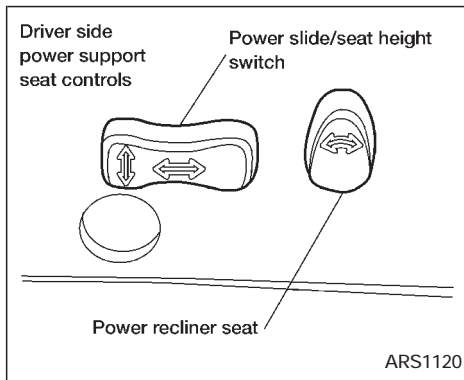

### Seat height adjustment

To raise the height of the seat, lift the power seat height switch and release it when the desired position is reached. To lower the height of the seat, push the power seat height switch down and release it when the desired position is reached.

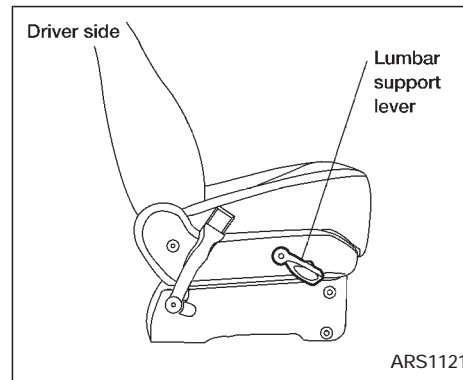

### Lumbar support

The lumbar support provides lower back support to the driver. Move the lever up or down to adjust the seat lumbar area.

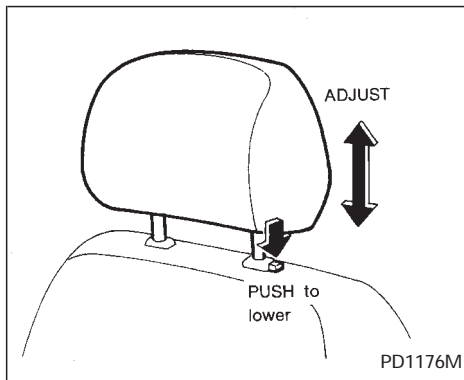

## HEAD RESTRAINTS

To raise the head restraint, pull it up. To lower, push in the release button and push the head restraint down.

The head restraints on the two-passenger bench seat equipped with the integrated child safety seats, are not adjustable or removable.

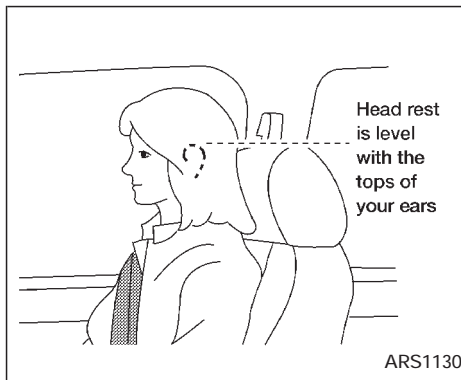

Adjust the head restraints so the top is level with the tops of your ears.

### **⚠ WARNING**

**Head restraints should be adjusted properly as they may provide significant protection against injury in an accident. Do not remove them. Check the adjustment after someone else uses the seat.**

Some seat arrangements may require removal of the head restraints when the seat is in a storage position and not to be used by passengers.

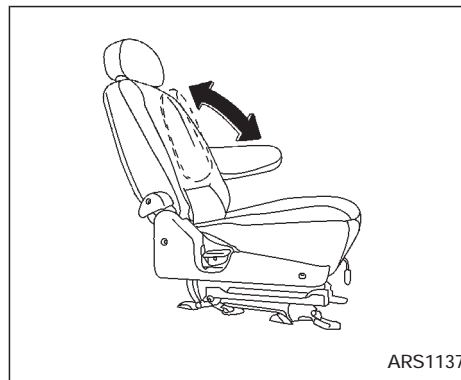

## ARMRESTS

To use the armrests on any seat, pull them down to the resting position.

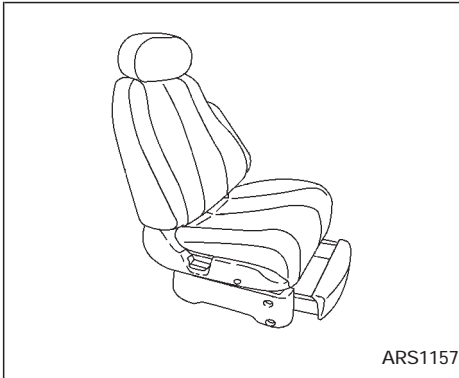

### UNDERSEAT STORAGE TRAY (if so equipped)

Some front passenger seats have an under-seat storage tray.

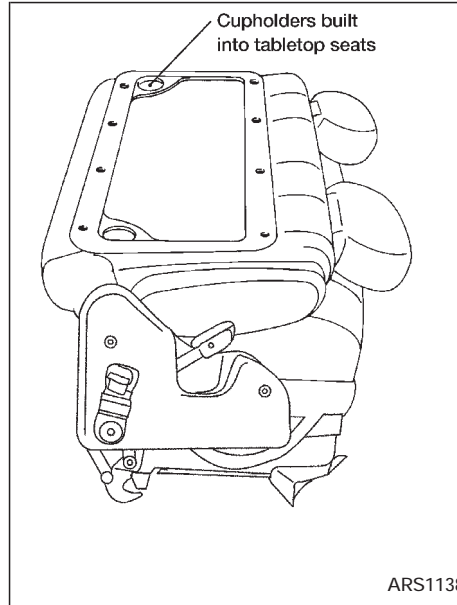

### TABLETOP SEATS

The second and third row seats convert into tabletops with built-in cupholders. To use the tabletop seats, lift up on the seatback release lever and fold the seatback forward.

### WARNING

- Never place hard items such as coffee mugs or drinking glasses on the tabletop seats when the vehicle is moving. Any item can become a projectile inside a vehicle involved in a collision. To help prevent personal injury, never leave loose items on the folded-down tabletop seats when the vehicle is moving.
- Do not use the tabletop and cup holder feature while the vehicle is in motion unless you are properly seated with your seat belt on.

# FLEXIBLE SEATING

## Removing the second row bench seat

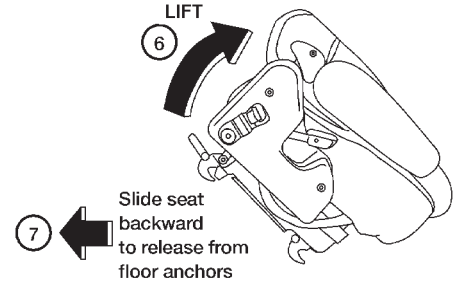
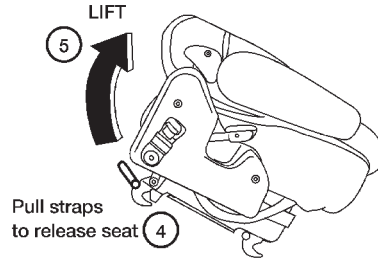
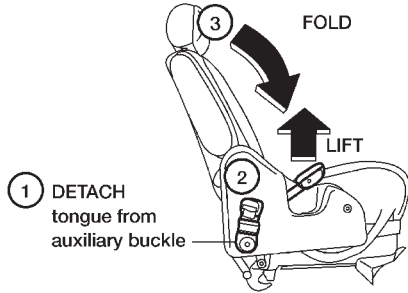

ARS1139

## Removing and installing the second row bench seat

### **⚠ WARNING**

- Do not remove or install seats while the vehicle is moving.
- After adjustment, gently rock in the seat to make sure it is securely locked.
- Do not ride in a moving vehicle when the seatback is reclined. This can be dangerous. The shoulder belt will not be against your body. In an accident you could be thrown into it and

receive neck or other serious injuries. You could also slide under the lap belt and receive serious internal injuries.

- For most effective protection when the vehicle is in motion, the seat should be upright. Always sit well back in the seat and adjust the seat belt properly. See “Precautions on Seat Belt Usage” later in this section.
- When adjusting or moving any of the seats in your vehicle, do not use any of the seat belt buckles, tongues, or

webbing to carry or move the seats. Lifting the seats by any of the seat belts could damage them. Damaged seat belts should be replaced at an authorized NISSAN dealer. Failure to follow these instructions could increase the chance and/or severity of injury in an accident.

### **⚠ CAUTION**

- The seats are heavy. Two people should remove or install them.

- **Do not sit in seats that have been removed from the vehicle. They may tip over and you could be injured.**

1. Detach the single window seat belt tongue from the auxiliary buckle mounted to the side of the seat and store the tongue out of the way. For detailed information, see “Two buckle seat belt system for the second row bench seat” later in this section.
2. Lift up the recliner lever.
3. Fold the seatback fully forward.
4. Unlock the seat legs at the two rear floor latches by pulling up on the two straps.
5. Lift the back of the seat.
6. Slide the seat rearward off the front anchor positions.

### Installing the second row bench seat

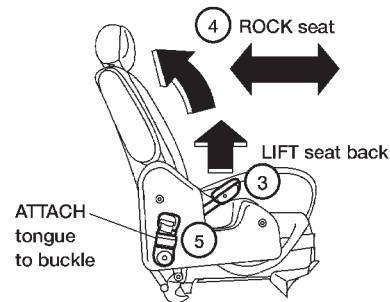
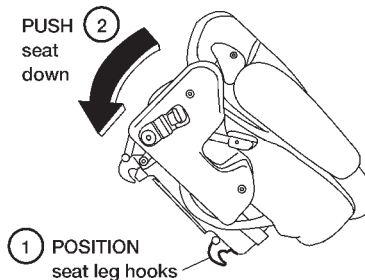

ARS1140

### Installing the second row bench seat

Clean the area around the seat leg floor anchors before installing the seat.

1. With the seatback fully folded, place the seat behind the floor anchors and catch the seat leg hooks into each floor anchor.
2. Push down on the back of the seat to secure the two rear floor latches.
3. Lift up the recliner lever and raise the seatback.
4. Rock the seat back and forth to be sure

all four seat legs are securely latched.

5. Insert the single window seat belt tongue into the auxiliary buckle mounted to the side of the seat.



## Removing second row bucket seats

### WARNING

- Do not remove or install seats while the vehicle is moving.
- After adjustment, gently rock in the seat to make sure it is securely locked.
- Do not ride in a moving vehicle when the seatback is reclined. This can be dangerous. The shoulder belt will not be against your body. In an accident you could be thrown into it and receive neck or other serious injuries. You could also slide under the lap belt and receive serious internal injuries.
- For most effective protection when the vehicle is in motion, the seat should be upright. Always sit well back in the seat and adjust the seat belt properly. See “Precautions on Seat Belt Usage” later in this section.

- When adjusting or moving any of the seats in your vehicle, do not use any of the seat belt buckles, tongues, or webbing to carry or move the seats. Lifting the seats by any of the seat belts could damage them. Damaged seat belts should be replaced at your NISSAN dealer. Failure to follow these instructions could increase the chance and/or severity of injury in an accident.

### CAUTION

- The seats are heavy. Two people should remove or install them.
- Do not sit in seats that have been removed from the vehicle. They may tip over and you could be injured.

## Removing the second row passenger side bucket seat

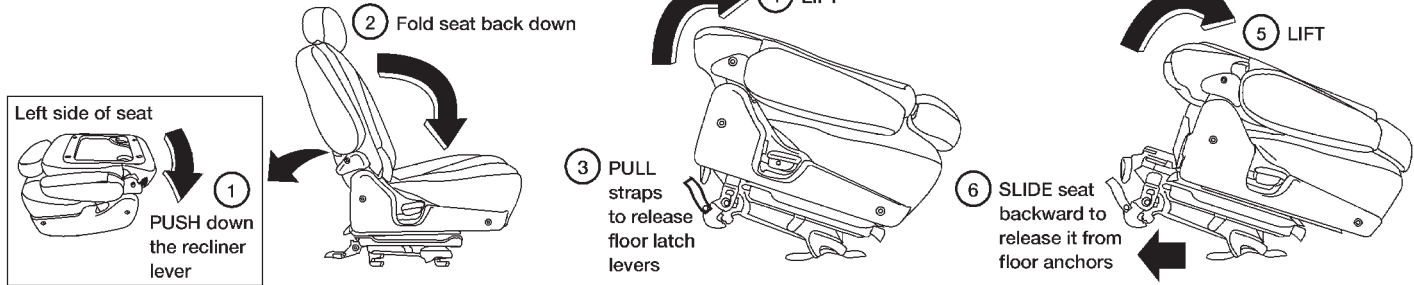

ARS1141

1. Lift the recliner lever.
2. Fold the seatback fully forward.

### Removing the second row driver side bucket seat

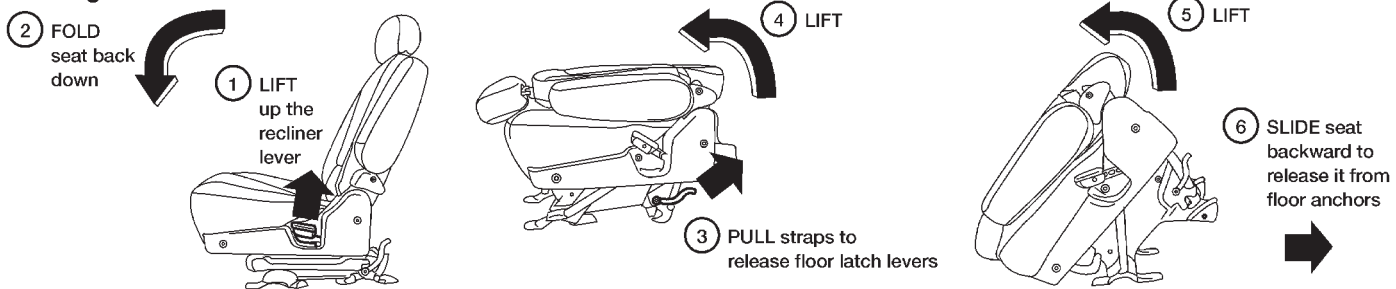

ARS1143

3. Unlock the seat legs at the two rear floor latch levers by pulling up on the two straps.
4. Lift the back of the seat and slide it rearward off the front anchor positions.

## Installing the second row bucket seats

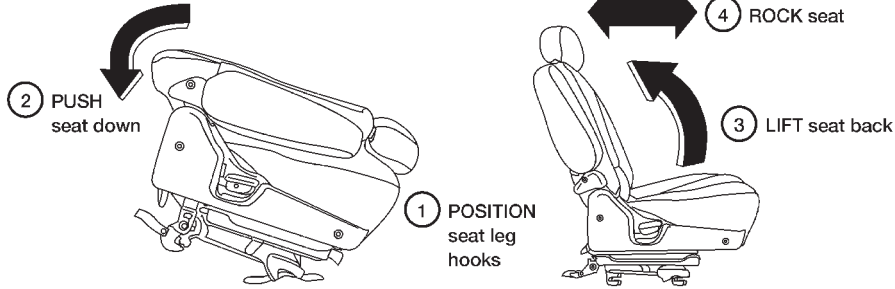

## Installing the bucket seats

Clean the area around the seat leg floor anchors before installing the seat.

1. With the seatback fully folded, place the seat behind the floor anchors and slide seat leg hooks so they catch into each floor anchor.
2. Push down on the rear of the seat to secure the two rear floor latches.
3. Lift the recliner lever and raise the seatback.

4. Rock the seat back and forth to be sure it is securely latched.

**The second row bucket seats are not interchangeable. If you are having difficulty installing the seats, you may have them in the wrong location.**

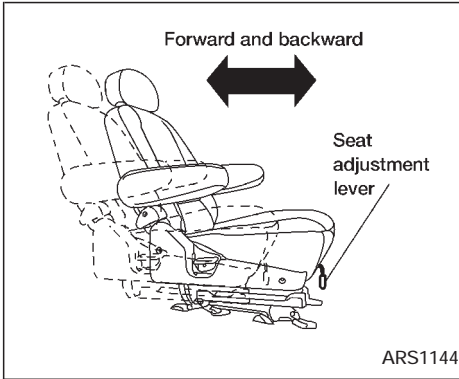

### Second row passenger side bucket seat

The bucket seat near the passenger side sliding door can be moved forward to allow easier entry and exit for third seat passengers.

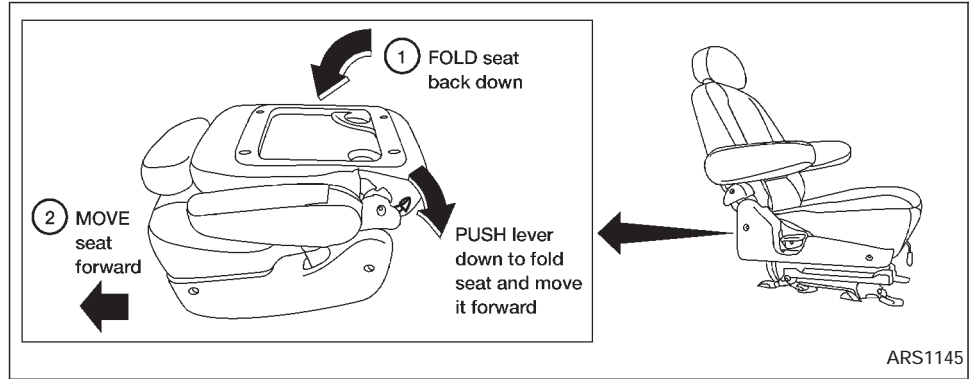

There is also a lever behind the bucket seat which allow third seat passengers to move the bucket seat forward without help from another passenger.

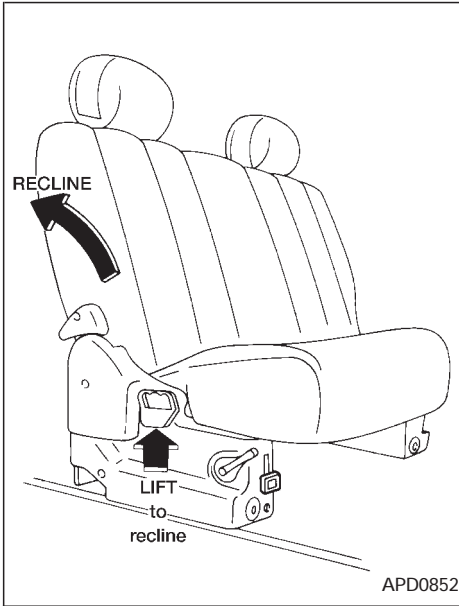

## SLIDING THREE-PASSENGER SEAT

### Reclining

To recline the three-passenger seat, lift up on the lever and lean back until the desired position is reached. To bring the seatback forward, pull the lever up and lean your body forward.

Some three-passenger seats do not have the recline feature.

### WARNING

- Do not recline the seatback while the vehicle is moving.
- Do not ride in a moving vehicle when the seatback is reclined. This can be dangerous. The shoulder belt will not be against your body. In an accident you could be thrown into it and receive neck or other serious injuries. You could also slide under the lap belt and receive serious internal injuries.

- For most effective protection when the vehicle is in motion, the seat should be upright. Always sit well back in the seat and adjust the seat belt properly. See “Precautions on Seat Belt Usage” later in this section.
- After adjustment, gently rock in the seat to be sure both sides are securely locked.

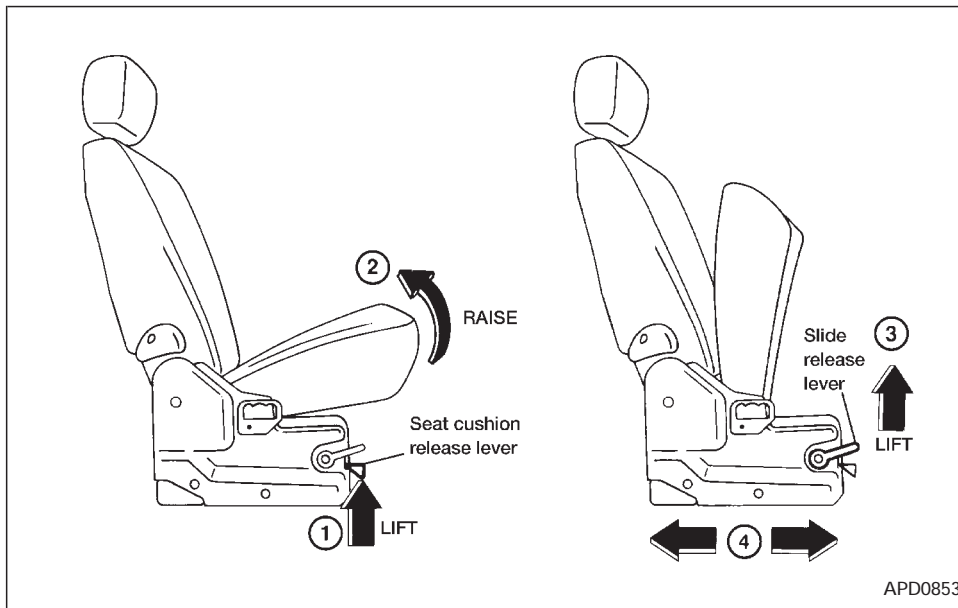

1. Lift the seat cushion release lever.
2. Lift the seat cushion up into the locked position.
3. Lift the slide release lever and grasp the bar under the seat in the center.
4. Slide the seat until locked at a passenger seating position or a storage position. After the seat starts moving, release the slide lever. The seat latches at the next latching position. Continue to lift and release the slide lever until the desired position is obtained.

To lower the cushion, the seat must be locked at a passenger seating position. Lift the seat cushion release lever and lower the cushion until locked.

**The seat cushion cannot be lowered in a storage position. This prevents a passenger from using a seat or seat belt that is out of a seating position.**

APD0853

### Sliding the three-passenger seat

Before sliding the seat, fasten the center belt tongue to the center buckle and remove the appropriate floor mats.

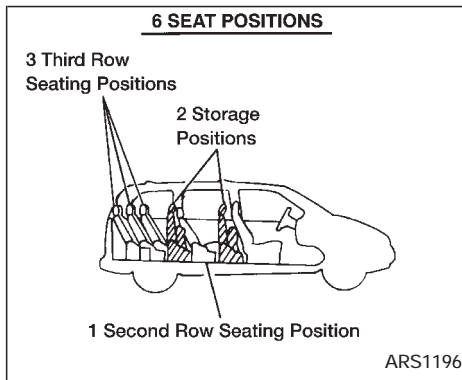

The seating system allows great flexibility. Proper usage is important to your safety.

**⚠ WARNING**

- Do not slide the seat while the vehicle is moving.
- After adjustment, gently rock in the seat to be sure it is securely locked.
- After sliding the seat, check that both sides of the seat are locked securely by attempting to move each side of the seat forward and backward. This must be done before the vehicle is

put into motion in order to prevent unintended movement of the seat and passenger injuries.

- Do not attempt to use the seats placed into a storage position for passengers because in this position the seat belts will not protect the occupants. Be sure to use the proper seat belts for each seat location. Improper seat belt usage will increase the risk of severe injury in an accident.
- When the vehicle is being used to carry cargo, properly secure all cargo to help prevent it from sliding or shifting. Do not place cargo higher than the seatbacks. In a sudden stop or collision, unsecured cargo could cause personal injury.
- Be careful not to damage the seat belt. Never allow anyone to ride in the cargo area or on a seat that is in a storage position. It is not designed for passengers. They could be injured in sudden braking or a collision.
- To prevent luggage or packages from sliding forward during braking,

do not stack anything in the cargo area higher than the seatbacks.

- It is extremely dangerous to ride in a cargo area inside of a vehicle. In a collision, people riding in these areas are more likely to be seriously injured or killed.
- Do not allow people to ride in any area of your vehicle that is not equipped with seats and seat belts.
- Be sure everyone in your vehicle is in a seat and using a seat belt properly.
- Be sure to replace and reposition floor mats as discussed in “Floor mat positioning” in this section.
- The three-passenger sliding bench seat is not intended to be removed from the vehicle by consumers. However, if it must be removed, have a qualified person remove it. That person should refer to the instructions in the Service Manual. When seat is reinstalled, the attaching bolts must be tightened to the appropriate torque specifications. Failure



**to follow these instructions could increase the chance and/or severity of injury in an accident.**

## Cleaning the seat tracks

The seat tracks for the three-passenger sliding bench seat should be cleaned periodically with a high-powered vacuum cleaner. Dirty seat tracks may reduce the sliding ability of the seat. A wet cleansing agent may be used if necessary, but the seat tracks must be thoroughly dried.

Use a cloth wrapped around a screwdriver (or similar object) to clean the seat tracks. Do not use your fingers to clean debris from the tracks.

Do not apply any type of lubricant to the seat tracks.



### **CAUTION**

**Never insert fingers into the seat track rails. The rails may be sharp and could cause injury.**

## SUPPLEMENTAL RESTRAINT SYSTEM (supplemental air bag system)

This Supplemental Restraint System description contains important information concerning the special driver and passenger supplemental air bag. The Supplemental Restraint System Air Bags can help reduce impact force to the driver and front passenger in certain frontal collisions. The supplemental air bags are designed to **supplement** the crash protection provided by the seat belts and are **not a substitute** for the seat belts. The seat belts should always be correctly worn and the driver and front passenger seated a suitable distance from the steering wheel and instrument panel. (See "Seat belts" for instructions and precautions on seat belt usage later in this section.)

**The supplemental air bags operate only when the ignition switch is in the ON or START position.**

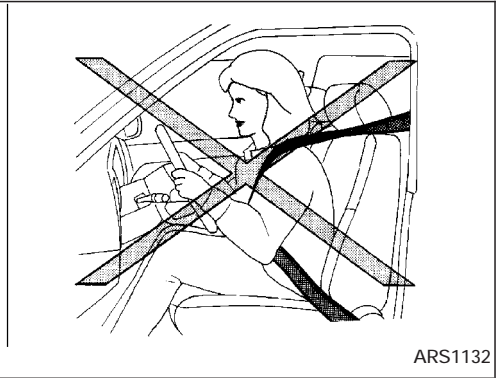

### WARNING

- The supplemental air bag ordinarily will not inflate in the event of a side impact, rear impact, roll over, or lower severity frontal collision. Always wear your seat belts to help reduce the risk or severity of injury in various kinds of accidents.
- The seat belts and the supplemental air bag are most effective when you are sitting back and upright in the seat. Supplemental air bags inflate with great force. If you are unrestrained, leaning forward, sitting sideways, you

are at greater risk of injury or death in a crash and may also receive serious or fatal injuries from the supplemental air bag if you are up against it when it inflates.

- Always sit back against the seatback and as far away as practical from the steering wheel or instrument panel. Always use the seatbelts.
- Keep hands on the outside of the steering wheel. Placing them inside the steering wheel rim could increase the risk that they are injured when the supplemental air bag inflates.

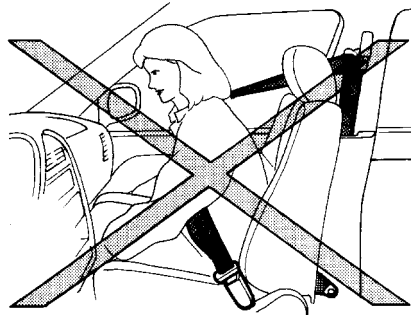

ARS1133

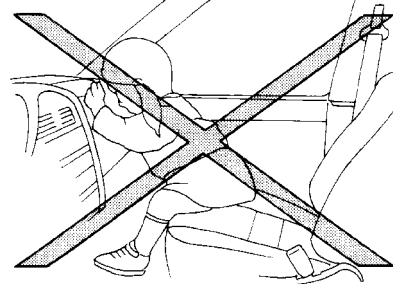

ARS1041

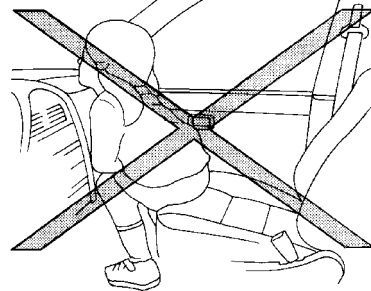

ARS1042

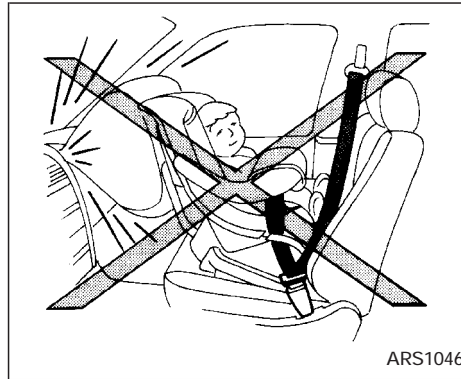
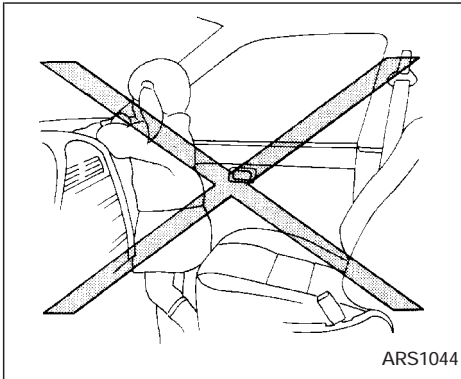
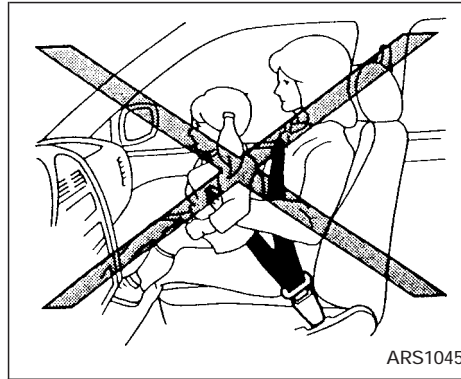
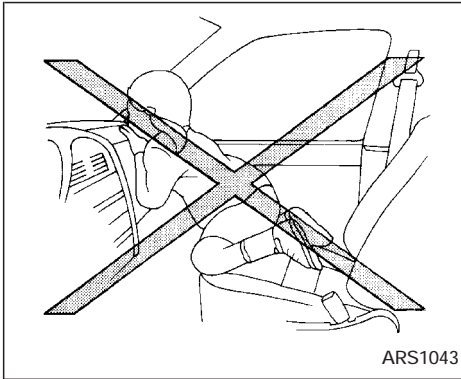

**⚠ WARNING**

- Never let children ride unrestrained. Do not attempt to hold them in your lap or arms. Some examples of dangerous riding positions are shown in the previous illustrations.
- Children may be severely injured or killed when the supplemental air bag inflates if they are not properly restrained.
- Never install a rear-facing child restraint in the front seat. An inflating supplemental air bag could seriously injure or kill your child. See “Child restraints” later in this section for details.

## SUPPLEMENTAL AIR BAG SYSTEM

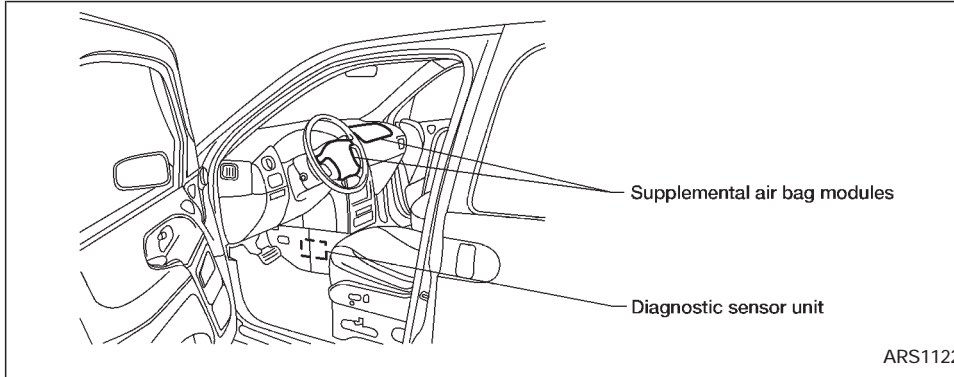

The driver supplemental air bag is located in the center of the steering wheel. The front passenger supplemental air bag is mounted in the dashboard above the glove box.

These systems are designed to meet optional certification requirements under U.S. regulations. They are also permitted in Canada. The optional certification allows air bags to be designed to inflate somewhat less forcefully than previously. **However, all of the information, cautions and warnings in this manual still apply and must be followed.**

The supplemental air bag system is designed to inflate in higher severity frontal collisions,

### 1-22 Seats, restraints and supplemental air bag systems

although it may inflate if the forces in another type of collision are similar to those of a higher severity frontal impact. It may not inflate in certain frontal collisions. Vehicle damage (or lack of it) is not always an indication of proper supplemental air bag system operation.

When the supplemental air bag inflates, a fairly loud noise may be heard, followed by the release of smoke. This smoke is not harmful and does not indicate a fire, but care should be taken not to unintentionally inhale it, as it may cause irritation and choking. Those with a history of a breathing condition should get fresh air promptly.

The supplemental air bags, along with the use of seat belts, help to cushion the impact force on the face and chest of the occupant. They can help save lives and reduce serious injuries. However, an inflating supplemental air bag may cause facial abrasions or other injuries. Supplemental air bags do not provide restraint to the lower body.

Seat belts should be correctly worn and the driver and passenger seated upright as far away as practical from the steering wheel or instrument panel. Since the supplemental air bag inflates quickly in order to help protect the occupant, the force of the supplemental air bag inflating can increase the risk of injury if the occupant is too close to or is against the supplemental air bag module during inflation.

The supplemental air bag deflates quickly after a collision. **The supplemental air bags operate only when the ignition switch is in the ON or START position.**

 **WARNING**

- Do not place any objects on the steering wheel pad or the instrument panel. Also, do not place any objects between any occupant and the steering wheel or instrument panel. Such objects may become dangerous projectiles and cause injury if the supplemental air bag inflates.
- Right after inflation, several supplemental air bag system components will be hot. Do not touch them; you may severely burn yourself.
- No unauthorized changes should be made to any components or wiring of the supplemental air bag system. This is to prevent accidental inflation of the supplemental air bag or damage to the supplemental air bag system.
- Do not make unauthorized changes to your vehicle's electrical system, suspension system or front end structure. This could affect proper operation of the supplemental air bag system.

- Tampering with the supplemental air bag system may result in serious personal injury. Tampering includes changes to the steering wheel and the instrument panel assembly by placing material over the steering wheel pad and above the instrument panel, or by installing additional trim material around the supplemental air bag system.
- Work around and on the supplemental air bag system should be done by an authorized NISSAN dealer. Installation of electrical equipment should also be done by an authorized NISSAN dealer. The yellow Supplemental Restraint System (SRS) wiring should not be modified or disconnected. Unauthorized electrical test equipment and probing devices should not be used on the supplemental air bag system.
- The SRS wiring harnesses are covered with yellow insulation either just before the harness connectors or over the complete harness for easy identification.

When selling your vehicle, we request that you inform the buyer about the supplemental air bag system and guide the buyer to the appropriate sections in this owner's manual.

## WARNING LABELS

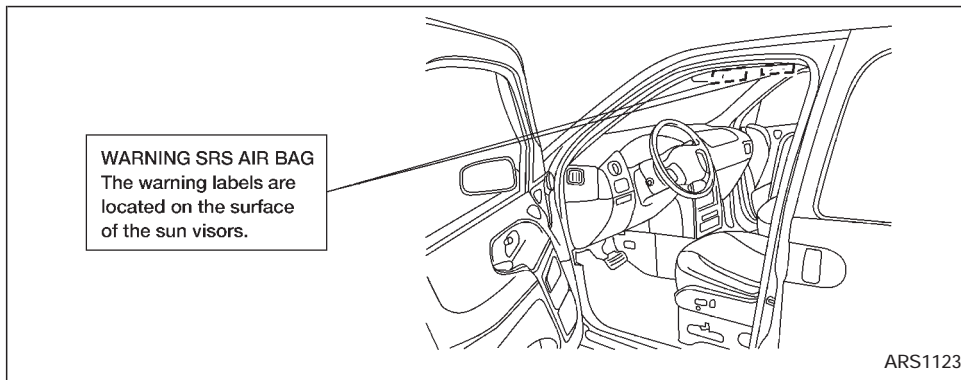

Warning labels about the supplemental air bag system are placed in the vehicle as shown in the illustration.

## SUPPLEMENTAL AIR BAG WARNING LIGHT

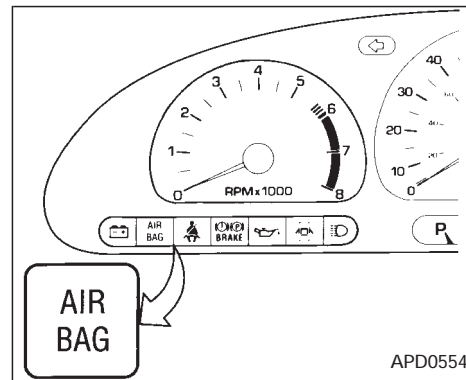

The supplemental air bag warning light, displaying <sup>AIR</sup>BAG in the instrument panel, monitors the circuits of the supplemental air bag system. The circuits monitored by the supplemental air bag warning light include the diagnosis sensor unit, supplemental air bag modules and all related wiring.

When the ignition key is in the ON or START position, the supplemental air bag warning light illuminates for about 7 seconds and then turns off. This means the system is operational.

If any of the following conditions occur, the supplemental air bag needs servicing and should be taken to your nearest authorized NISSAN dealer:

1. The supplemental air bag light does not come on and remain on for 7 seconds and then go off as described.
2. The supplemental air bag light flashes intermittently, or remains on after 7 seconds.
3. The supplemental air bag light does not come on at all.

Under these conditions, the Supplemental Restraint System Air Bag may not operate properly. It must be checked and repaired. Take your vehicle to the nearest authorized NISSAN dealer.

 **WARNING**

**If the supplemental air bag warning light is on, it could mean that the supplemental air bag system will not operate in an accident.**

## Repair and replacement procedure

The supplemental air bag modules are designed to inflate on a one-time-only basis. As a reminder, unless it is damaged, the supplemental air bag light remains illuminated after inflation has occurred. Repair and replacement of the supplemental air bag system should be done only by an authorized NISSAN dealer.

**To ensure long-term functioning, the supplemental air bag system must be inspected 10 years after the date of manufacture as noted on the certification label located on the driver side front pillar.**

When maintenance work is required on the vehicle, the supplemental air bag system and related parts should be pointed out to the person conducting the maintenance. The ignition key should always be in the LOCK position when working under the hood or inside the vehicle.

 **WARNING**

- **Once the supplemental air bag inflates, the supplemental air bag module will not function again and should be replaced by an authorized NISSAN dealer. The supplemental air bag module cannot be repaired.**
- **The supplemental air bag system should be inspected by an authorized NISSAN dealer if there is any damage to the front end portion of the vehicle.**
- **If you need to dispose of a supplemental air bag or scrap the vehicle, contact an authorized NISSAN dealer. Correct supplemental air bag disposal procedures are set forth in the appropriate NISSAN Service Manual. Incorrect disposal procedures could cause personal injury.**



## SEAT BELTS

### PRECAUTIONS ON SEAT BELT USAGE

Your chances of being injured or killed in an accident and/or the severity of injury may be greatly reduced if you are wearing your seat belt and it is properly adjusted. NISSAN strongly encourages you and all of your passengers to buckle up every time you drive, even if your seating position includes a supplemental air bag.

**Most U.S. States and Canadian provinces or territories require that seat belts be worn at all times when a vehicle is being driven.**

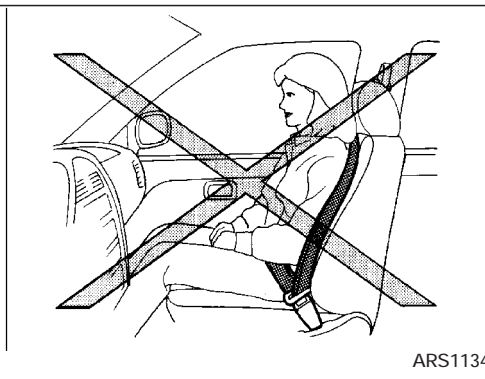
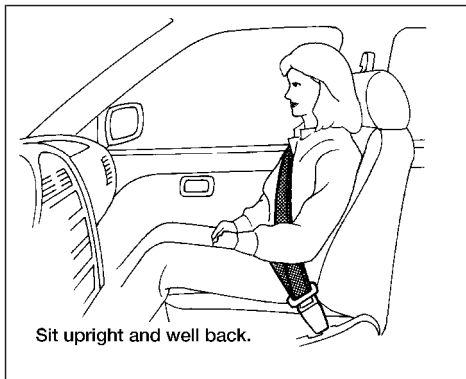

#### WARNING

- Every person who drives or rides in this vehicle should use a seat belt at all times. Children should be properly restrained and, if appropriate, in a child restraint.
- The belt should be adjusted to a snug fit. Failure to do so may reduce the effectiveness of the entire restraint system and increase the chance or severity of injury in an accident. Serious injury or death can occur if the seat belt is not worn properly.
- Always route the shoulder belt over your shoulder and across your chest. Never run the belt behind your back, under your arm or across your neck. The belt should be away from your face and neck, but not falling off your shoulder.
- Position the lap belt as low and snug as possible **AROUND THE HIPS, NOT THE WAIST**. A lap belt worn too high could increase the risk of internal injuries in an accident.

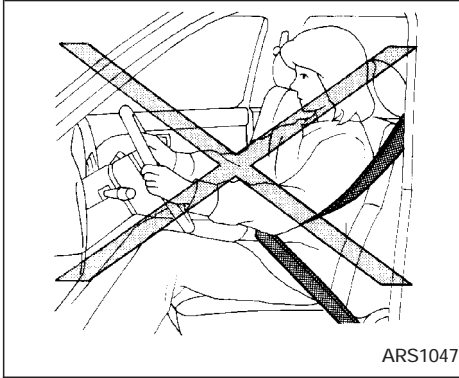

- Be sure the seat belt tongue is securely fastened to the proper buckle.
- Do not wear the belt inside out or twisted. Doing so may reduce its effectiveness.
- Do not allow more than one person to use the same seat belt.
- Never carry more people in the vehicle than there are seat belts.

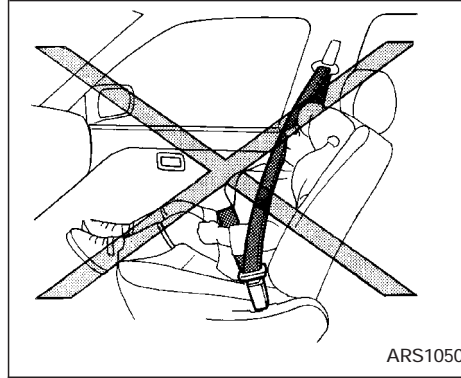

- If the seat belt warning light glows continuously while the ignition is turned ON with all doors closed and all seat belts fastened, it may indicate a malfunction in the system. Have the system checked by an authorized NISSAN dealer.
- All seat belt assemblies, including retractors and attaching hardware, should be inspected by an authorized NISSAN dealer after any collision. NISSAN recommends that all seat

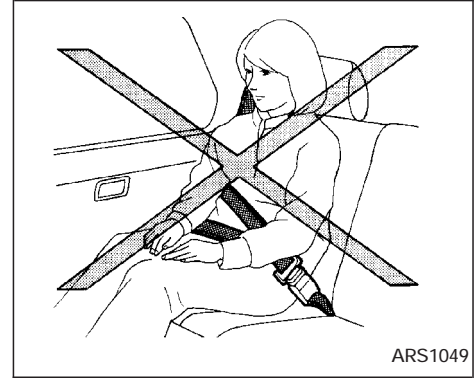

belt assemblies in use during a collision be replaced unless the collision was minor and the belts show no damage and continue to operate properly. Seat belt assemblies not in use during a collision should also be inspected and replaced if either damage or improper operation is noted.

## CHILD SAFETY

Children need adults to help protect them. They need to be properly restrained.

The proper restraint depends on the child's size. Generally, infants up to about

1 year and less than 20 pounds (9 kg) should be placed in rear facing child restraints. Forward facing child restraints are available for children who outgrow rear facing child restraints.

 **WARNING**

Infants and children need special protection. The vehicle's seat belts may not fit them properly. The shoulder belt may come too close to the face or neck. The lap belt may not fit over their small hip bones. In an accident an improperly fitting seat belt could cause serious or fatal injury. Always use appropriate child restraints.

All US States and Canadian provinces require the use of approved child restraints for infants and small children. See "Child restraints" later in this section.

In addition, there are many types of child restraints available for larger children which should be used for maximum protection.

**NISSAN recommends that all preteens and children be restrained in the rear seat if possible. According to accident statistics, children are safer when prop-**

1-28 **Seats, restraints and supplemental air bag systems**

**erly restrained in the rear seat than in the front seat.**

**This is especially important because your vehicle has a supplemental restraint system (Air bag system) for the front passenger (For precautions, see "Supplemental restraint system" earlier in this section).**

### Infants and small children

NISSAN recommends that infants and small children be placed in a child restraint that complies with the Federal Motor Vehicle Safety Standards or Canadian Motor Vehicle Safety Standards. You should choose a child restraint that fits your vehicle and always follow the manufacturer's instructions for installation and use.

### Larger children

Children who are too large for child restraints should be seated and restrained by the seat belts which are provided.

If the child's seating position has a shoulder belt that fits close to the face or neck, the use of a booster seat (commercially available) may help overcome this. The booster seat should raise the child so the shoulder belt is properly positioned across the top, middle portion of the shoulder and the lap belt is low

on the hips. The booster seat should fit the vehicle seat and have a label certifying that it complies with Federal Motor Vehicle Safety Standards or Canadian Motor Vehicle Safety Standards. Once the child has grown enough so the shoulder belt is no longer on or near the face and neck, use the shoulder belt without the booster seat.

 **WARNING**

**Never let a child stand or kneel on any seat and do not allow a child in the cargo areas while the vehicle is moving. The child could be seriously injured or killed in an accident.**

### PREGNANT WOMEN

NISSAN recommends that pregnant women use seat belts. Contact your doctor for specific recommendations. The lap belt should be worn snug and positioned as low as possible around the hips, not the waist.

### INJURED PERSONS

NISSAN recommends injured persons use seat belts, depending on the injury. Check with your doctor for specific recommendations.

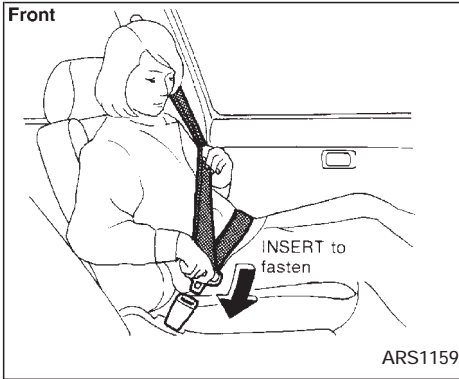

## THREE-POINT TYPE WITH RETRACTOR

### **⚠ WARNING**

- Every person who drives or rides in this vehicle should use a seat belt at all times.
- Do not ride in a moving vehicle when the seatback is reclined. This can be dangerous. The shoulder belt will not be against your body. In an accident

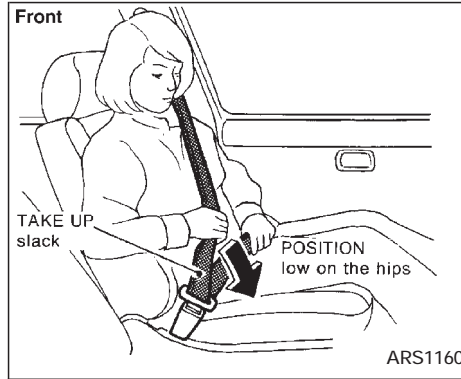

you could be thrown into it and receive neck or other serious injuries. You could also slide under the lap belt and receive serious internal injuries.

- For most effective protection when the vehicle is in motion, the seat should be upright. Always sit well back in the seat and adjust the seat belt properly.

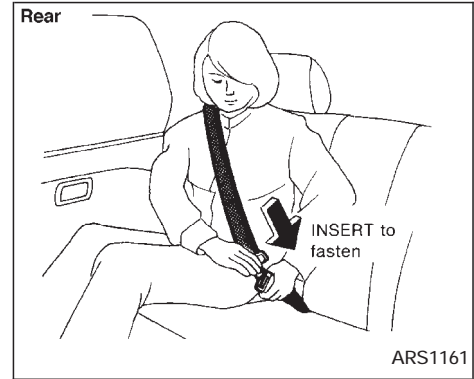

## Fastening the seat belts

1. Adjust the seat.
2. Slowly pull the seat belt out of the retractor and insert the tongue into the buckle until it clicks.

The retractor is designed to lock during a sudden stop or on impact. A slow pulling motion permits the seat belt to move, and allows you some freedom of movement in the seat.

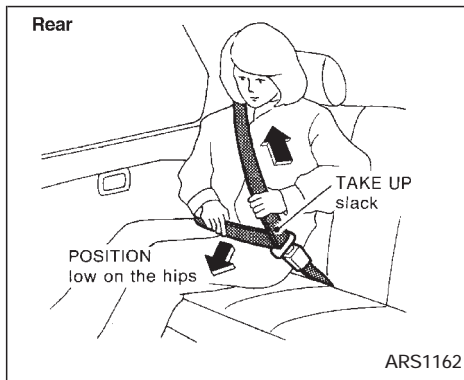

3. Position the lap belt portion **low and snug on the hips** as shown.
4. Pull the shoulder belt portion toward the retractor to take up extra slack.

The front seat passenger seat belt and rear three-point seat belts have a cinching mechanism for child restraint installation. It is referred to as the automatic locking mode.

When the automatic locking mode is activated, the seat belt cannot be withdrawn again until the seat belt tongue is detached from the buckle and fully retracted. Refer to

“Child restraints” later in this section for more information.

**The automatic locking mode should be used only for child restraint installation. During normal seat belt use by a passenger, the locking mode should not be activated. If it is activated, it may cause uncomfortable seat belt tension.**

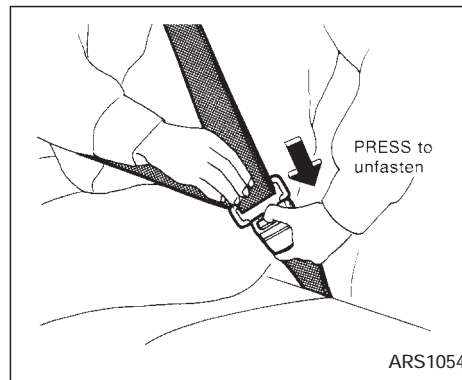

### Unfastening the seat belts

To unfasten the seat belt, press the button on the buckle. The seat belt automatically retracts.

### Checking seat belt operation (Three-point type seat belt with retractor)

Seat belt retractors are designed to lock seat belt movement:

- 1) when the seat belt is pulled quickly from the retractor, and
- 2) when the vehicle slows down rapidly.

To increase your confidence in the seat belts, check their operation as follows.

- Grasp the shoulder belt and pull quickly forward. The retractor should lock and restrict further belt movement.

If the retractor does not lock during this check or if you have any questions about belt operation, see an authorized NISSAN dealer.

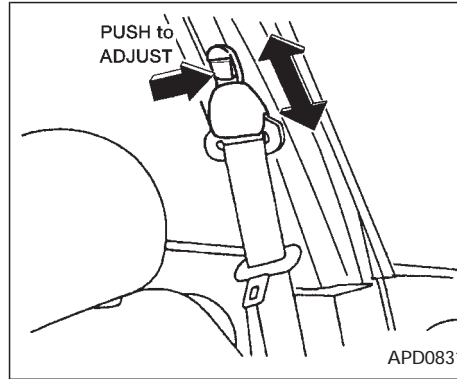

### Shoulder belt height adjustment

The shoulder belt anchor height should be adjusted to the position best for you (See “Precautions on seat belt usage” earlier in this section.). To adjust, press the release button and move the shoulder belt anchor to the desired position so the belt passes over the center of the shoulder. The belt should be away from your face and neck, but not falling off your shoulder. Release the button to lock the shoulder belt anchor into position.

### WARNING

- After adjustment, release the button and try to move the shoulder belt anchor up and down to make sure it is securely fixed in position.
- The shoulder belt height should be adjusted to the position best for you. Failure to do so may reduce the effectiveness of the entire restraint system and increase the chance or severity of injury in an accident.

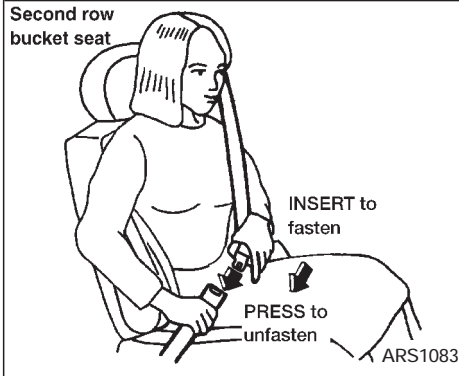

### THREE-POINT TYPE SEAT BELT WITH RETRACTOR FOR SECOND ROW BUCKET SEATS

#### **⚠ WARNING**

- Every person who drives or rides in this vehicle should use a seat belt at all times.
- Do not ride in a moving vehicle when the seatback is reclined. This can be dangerous. The shoulder belt will

not be against your body. In an accident you could be thrown into it and receive neck or other serious injuries. You could also slide under the lap belt and receive serious internal injuries.

- For most effective protection when the vehicle is in motion, the seat should be upright. Always sit well back in the seat and adjust the seat belt properly.

#### Fastening the seat belt

1. Adjust the seat.
2. Slowly pull the seat belt out of the retractor and insert the tongue into the buckle until it clicks.

The retractor is designed to lock during a sudden stop or on impact. A slow pulling motion permits the seat belt to move, and allows you some freedom of movement in the seat.

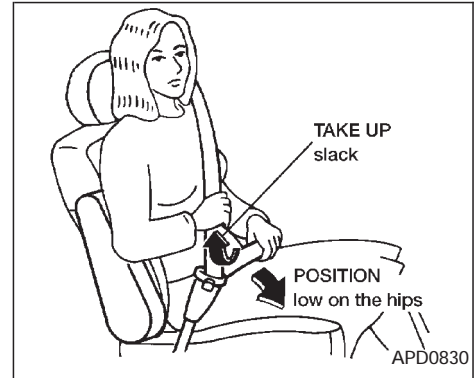

3. Position the lap belt portion **low on the hips** as shown.
4. Pull the shoulder belt portion toward the retractor to take up extra slack.

## Two buckle seat belt system for the second row bench seat

There is a two buckle seat belt system for the seating position of the second row bench seat next to the sliding door.

### WARNING

- It is very important that you follow the instructions in this section before anyone rides in this seating position of the two-passenger bench seat.
- Failure to do so may result in improper positioning of seat belt which could lead to increased likelihood or severity of injury in a sudden stop or collision.

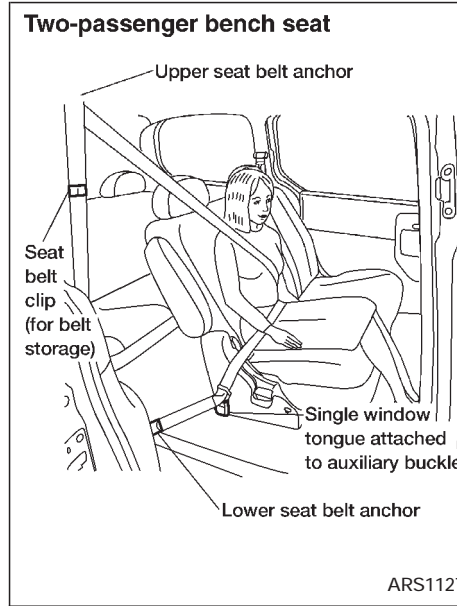

The two-passenger bench seat in the second row has a seat belt system made up of two buckles and two tongues. There are two body attaching points (one upper and one lower) that attach each end of the seat belt webbing.

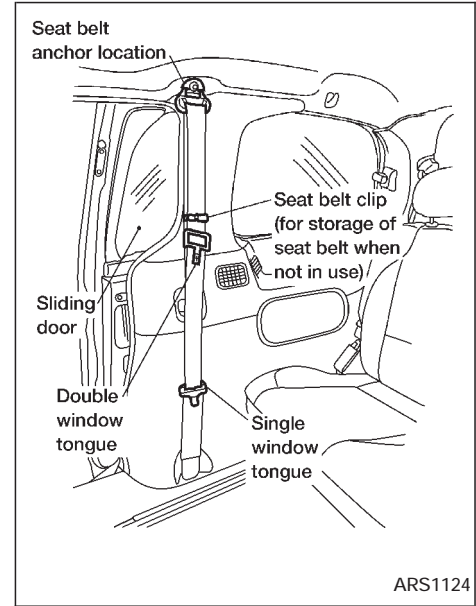

One of the seat belt tongues has two “windows” (or holes) and the other has only one “window”. The seat belt tongue with one window attaches to the auxiliary buckle mounted to the side of the seat. The seat belt tongue with two windows should be



positioned properly and fastened to the buckle mounted in the middle of the seat.

When the two buckle seat belt system is not in use, the webbing can be secured with the seat belt clip. The seat belt clip should not be used with a child seat or during seat belt usage. The seat belt clip opening should face the front of the vehicle.

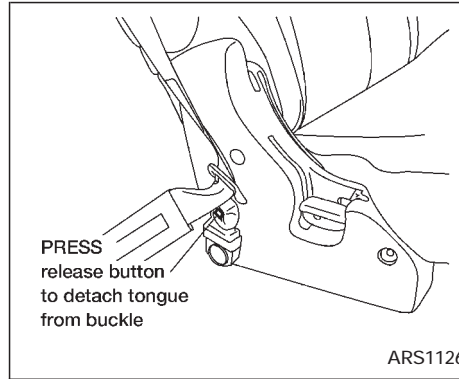

A twisted belt may prevent the retractor from working properly. If the two buckle seat belt system is twisted, disengage the single window tongue from the auxiliary buckle on the side of the seat, remove the twist and reinstall the tongue into the auxiliary buckle until you hear a snap and feel the latch engage.

**Both tongues must be attached to their appropriate buckles whenever someone is riding in that seating position. If the tongue are released to allow a third row passenger to enter or exit, the tongues must be reattached.**

When the two-passenger bench seat is removed from the vehicle, you must detach the single window tongue from the auxiliary buckle.

**If the three-passenger bench seat is moved up to the second row position, the outside passenger (near the passenger side sliding door) only needs to use the double window tongue and the standard buckle. Because the three-passenger bench seat is wider and closer to the passenger side sliding door, the single window seat belt tongue and the auxiliary buckle are not necessary.**

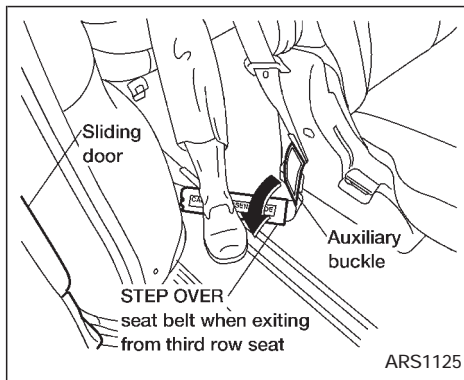

**CAUTION**

**Third row passengers must be very careful when exiting because of the auxiliary seat belt. It is important to step over the seat belt guide and belt webbing to avoid tripping.**

### Unfastening the seat belts

To unfasten the seat belt, press the button on the buckle. The seat belt automatically retracts.

### Checking seat belt operation (Three-point type seat belt with retractor)

Seat belt retractors are designed to lock seat belt movement:

- 1) when the seat belt is pulled quickly from the retractor, and
- 2) when the vehicle slows down rapidly.

To increase your confidence in the seat belts, check their operation as follows.

- Grasp the shoulder belt and pull quickly forward. The retractor should lock and restrict further belt movement.

If the retractor does not lock during this check or if you have any questions about seat belt operation, see an authorized NISSAN dealer.

### THREE PASSENGER BENCH SEAT IN THE SECOND ROW POSITION

#### Fastening the seat belts

**When the three-passenger bench seat is moved up to the second row position, the passenger, on the passenger side, only needs to use the double window tongue and the standard buckle. Because the three-passenger bench seat is wider and closer to the passenger side sliding doors, the single window seat belt tongue and the auxiliary buckle are not necessary.**

1. Adjust the seat.

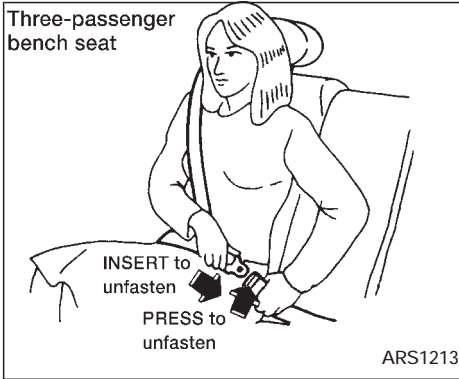

2. Slowly pull the seat belt out of the retractor and insert the tongue into the buckle until it snaps.

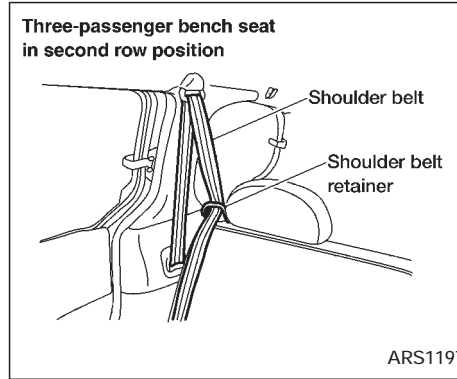

3. Position the passenger side shoulder belt **in the shoulder belt retainer.**

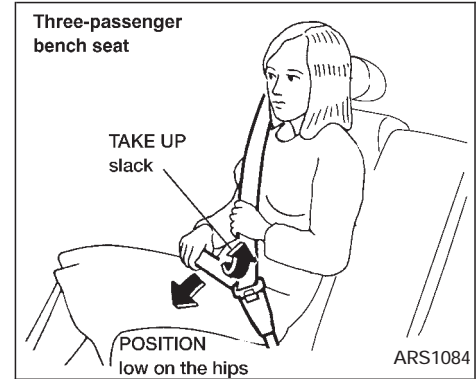

4. Position the lap belt portion **low on the hips as shown.**
5. Pull the shoulder belt portion toward the retractor to take up extra slack.

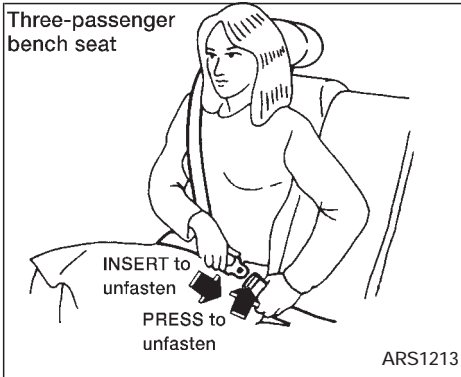

## THREE-PASSENGER BENCH SEAT

### Fastening the seat belts

1. Adjust the seat.

### WARNING

- Do not ride in a moving vehicle when the seatback is reclined. This can be dangerous. The shoulder belt will not be against your body. In an accident you could be thrown into it and receive neck or other serious injuries. You could also slide under the lap belt and receive serious internal injuries.
- For most effective protection when the vehicle is in motion, the seat should be upright. Always sit well back in the seat and adjust the seat belt properly.

Third row passenger shoulder belts are located slightly behind the third row seating position. Never try to use the seat belts for the second row passengers which are in front of the three-passenger bench seat.

### WARNING

Use of the second row three-point seat belts by third row passengers could increase the chance or severity of injury in a sudden stop or an accident.

2. Slowly pull the seat belt out of the retractor and insert the tongue into the buckle until it snaps.

The retractor is designed to lock during a sudden stop or on impact. A slow pulling motion permits the belt to move, and allows you some freedom of movement in the seat.

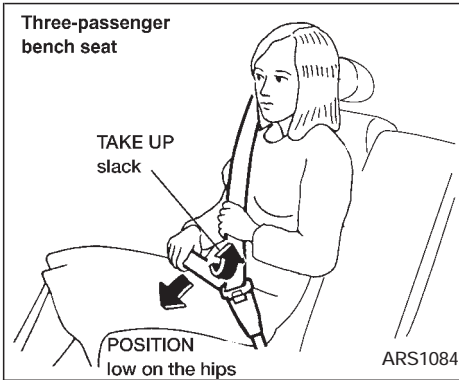

3. Position the lap belt portion **low on the hips as shown**.
4. Pull the shoulder belt portion toward the retractor to take up extra slack.

## TWO-POINT TYPE WITHOUT RETRACTOR (Center of three-passenger bench seat)

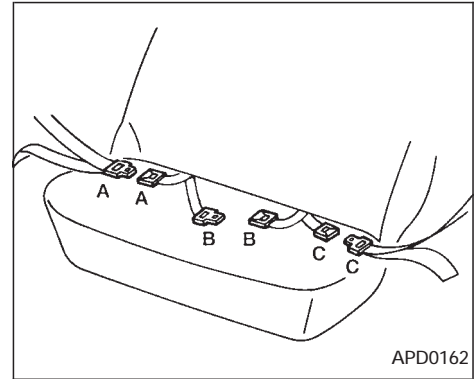

### Selecting correct set of belts

The seat belt tongues must be fastened into the seat belt buckles as illustrated above.

#### **WARNING**

**Any rear seat belt tongue will connect to any seat belt buckle; therefore, it is important to follow the illustration above. Failure to do so could increase the chance and/or severity of injury in an accident.**

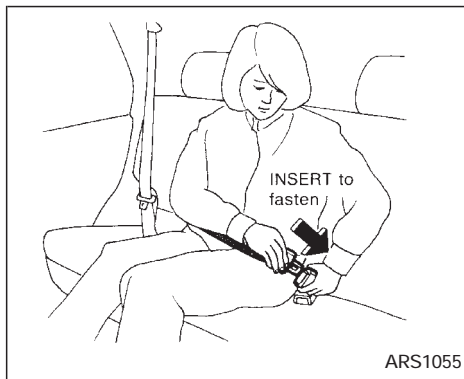

### Fastening the seat belt

1. Insert the tongue into the buckle until it clicks.

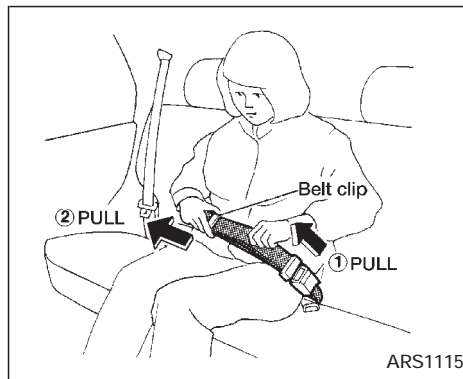

2. Tighten the belt by pulling the free end of the belt away from the tongue, then pull the belt clip to take up the slack.

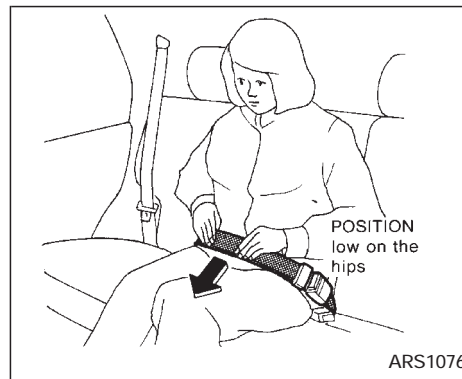

3. Position the lap belt **low on the hips** as shown.

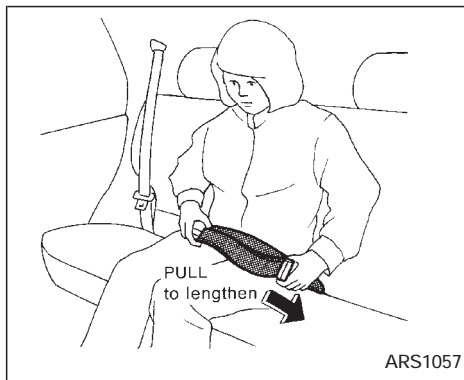

4. Loosen the belt by holding the tongue at a right angle to the belt, then pull on the belt.

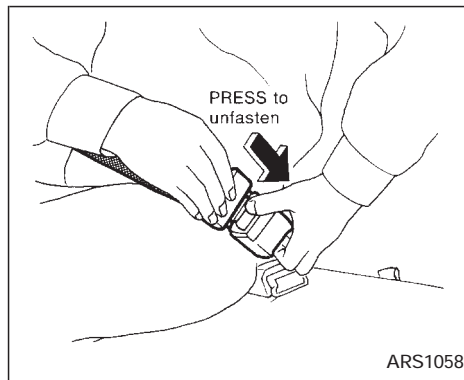

### Unfastening the belts

To unfasten the belt, press the button on the buckle.

### SEAT BELT EXTENDERS

If, because of body size or driving position, it is not possible to properly fit the front seat lap belts and fasten them, an extender is available which is compatible with the installed seat belts. The extender adds approximately 8 inches (200 mm) of length and may be used for either the driver or front passenger seating position. See an autho-

rized NISSAN dealer for assistance if the extender is required.

### **⚠ WARNING**

- Only NISSAN seat belt extenders, made by the same company which made the original equipment seat belts, should be used with NISSAN seat belts.
- Persons who can use the standard seat belt should not use an extender. Such unnecessary use could result in serious personal injury in the event of an accident.

### SEAT BELT MAINTENANCE

- To clean the seat belt webbings, apply a mild soap solution or any solution recommended for cleaning upholstery or carpet. Then wipe with a cloth and allow the seat belts to dry in the shade. Do not allow the seat belts to retract until they are completely dry.
- If dirt builds up in the shoulder belt guide of the seat belt anchors, the seat belts may retract slowly. Wipe the shoulder belt guide with a clean, dry cloth.

## CHILD RESTRAINTS

- **Periodically check to see that the seat belt and the metal components** such as buckles, tongues, retractors, flexible wires and anchors work properly. If loose parts, deterioration, cuts or other damage on the webbing is found, the entire seat belt assembly should be replaced.

### WARNING

- **Infants and small children should always be placed in an appropriate child restraint system while riding in the vehicle. Failure to use a child restraint can result in serious injury or death.**
- **Infants and small children should never be carried on your lap. It is not possible for even the strongest adult to resist the forces of a severe accident. The child could be crushed between the adult and parts of the vehicle. Also, do not put the same seat belt around both your child and yourself.**
- **Never install a rear-facing child restraint in the front seat. An inflating air bag could seriously injure or kill your child. A rear-facing child restraint must only be used in the rear seat.**
- **NISSAN recommends that the child restraint be installed in a rear seat. According to accident statistics, children are safer when properly restrained in a rear seat than in a front seat.**

- **An improperly installed child restraint could lead to serious injury in an accident.**
- **In general, child restraint systems are designed to be installed with a lap belt or the lap portion of a three-point type seat belt.**

Child restraints for infants and children of various sizes are offered by several manufacturers. When selecting any child restraint, keep the following points in mind:

- 1) Choose only a restraint with a label certifying that it complies with Federal Motor Vehicle Safety Standard 213 or Canadian Motor Vehicle Safety Standard 213.
- 2) Check the child restraint in your vehicle to be sure it is compatible with the vehicle's seat and seat belt system. Choose a child restraint that meets the guidelines of the Society of Automotive Engineers recommended practice J1819 for child seat installation.
- 3) If the child restraint is compatible with your vehicle, place your child in the child restraint and check the various adjustments to be sure the child restraint is



compatible with your child. Always follow all recommended procedures.

All U.S. states and some provinces or territories of Canada require that infants and small children be restrained in approved child restraints at all times while the vehicle is being operated.

 **WARNING**

- Improper use of a child restraint can result in increased injuries for both the infant or child and other occupants in the vehicle.
- Follow all of the child restraint manufacturer's instructions for installation and use. When purchasing a child restraint, be sure to select one which will fit your child and vehicle. It may not be possible to properly install some types of child restraints in your vehicle.
- If the child restraint is not anchored properly, the risk of a child being injured in a collision or a sudden stop greatly increases.

- Adjustable seatbacks should be positioned to fit the child restraint, but as upright as possible.
- After attaching the child restraint, test it before you place the child in it. Tilt it from side to side. Try to tug it forward and check to see if the belt holds the restraint in place. If the restraint is not secure, tighten the belt as necessary, or put the restraint in another seat and test it again.
- For a front facing child restraint, if the seat position where it is installed has a three-point type lap/shoulder belt, check to make sure the shoulder belt does not go in front of the child's face or neck. If it does, put the shoulder belt behind the child restraint. If you must install a front facing child restraint in the front seat, see "Installation on front passenger seat" later in this section.
- When your child restraint is not in use, keep it secured with a seat belt to prevent it from being thrown around in case of a sudden stop or accident.

 **CAUTION**

Remember that a child restraint left in a closed vehicle can become very hot. Check the seating surface and buckles before placing your child in the child restraint.

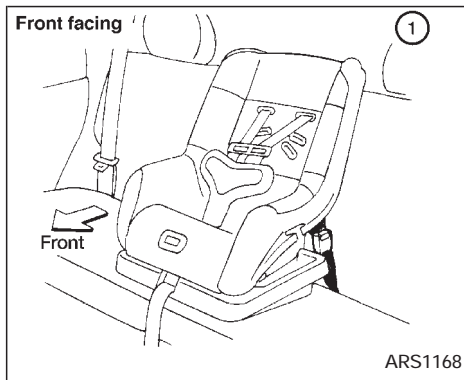

## FRONT FACING INSTALLATION AT THREE-PASSENGER BENCH SEAT CENTER POSITION

When you install a child restraint in a rear center seat, follow these steps:

1. Position the child restraint on the seat as illustrated. Always follow the restraint manufacturer's instructions.

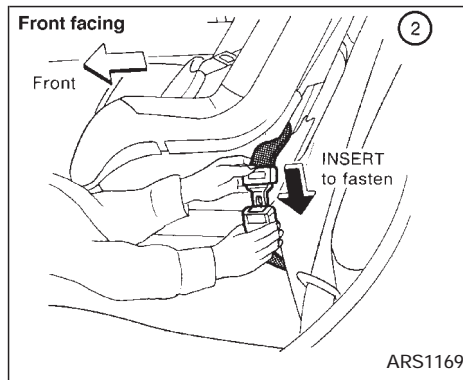

2. Route the seat belt tongue through the child restraint and insert it into the buckle until you hear and feel the latch engage.

Be sure to follow the child restraint manufacturer's instructions for belt routing.

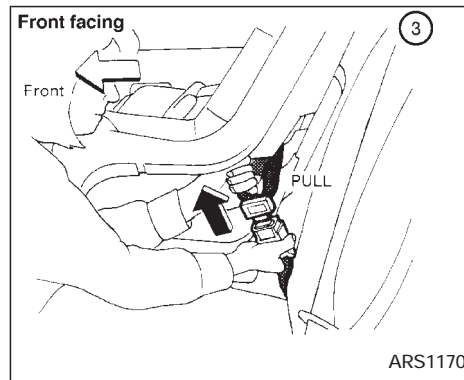

3. Remove all slack in the lap belt for a very tight fit by pulling forcefully on the lap belt adjustment.

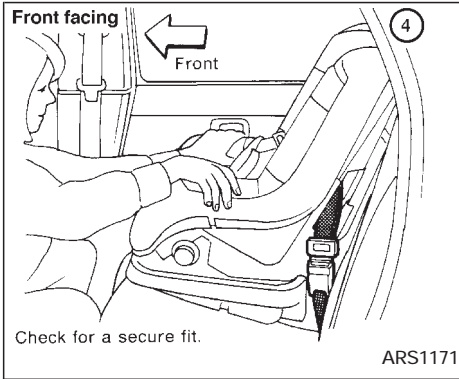

4. Before placing the child in the child restraint, use force to tilt the child restraint from side to side, and tug it forward to make sure it is securely in place.
5. If it is not secure, try to tighten the belt again, or put the restraint in another seat.
6. Check to make sure the child restraint is properly secured prior to each use.

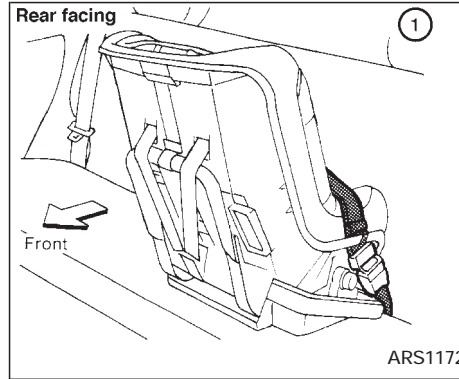

## REAR FACING INSTALLATION AT THREE-PASSENGER BENCH SEAT CENTER POSITION

When you install a child restraint in a rear center seat, follow these steps:

1. Position the child restraint on the seat as illustrated. Always follow the restraint manufacturer's instructions.

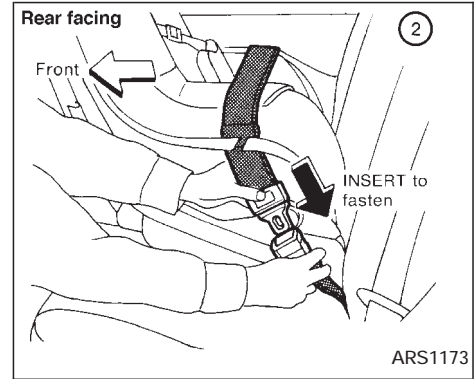

2. Route the seat belt tongue through the child restraint and insert it into the buckle until you hear and feel the latch engage. Be sure to follow the child restraint manufacturer's instructions for belt routing.

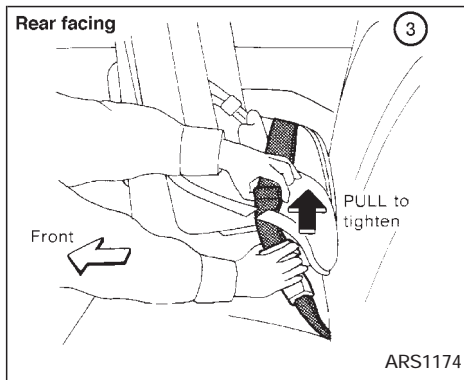

3. Remove all slack in the lap belt for a very tight fit by pulling forcefully on the lap belt adjustment.

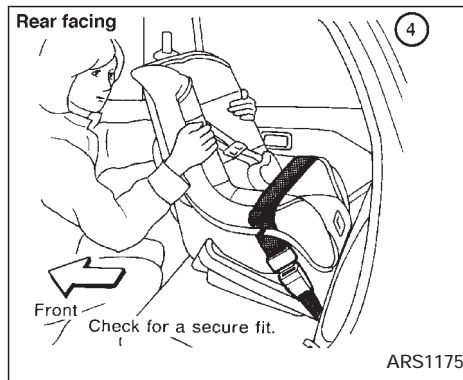

4. Before placing the child in the child restraint, use force to tilt the child restraint from side to side, and tug it forward to make sure it is securely in place.
5. If it is not secure, try to tighten the belt again, or put the restraint in another seat.
6. Check to make sure the child restraint is properly secured prior to each use.

## FRONT FACING INSTALLATION AT SECOND AND THIRD ROW OUTBOARD POSITIONS

The following instructions apply to second row bucket seats, the second row bench seat and the outboard positions of the three-passenger bench seat.

### **WARNING**

When installing a child restraint in the two-passenger bench seat, if it is placed in the seating position next to the passenger side sliding door, be sure both the auxiliary buckle and main buckle are properly fastened. Failure to do so could increase the chance and/or severity of injury in an accident.

**⚠ WARNING**

- The three-point belt in your vehicle is equipped with an automatic locking mode retractor which must be used when installing a child restraint.
- Failure to use the retractor's locking mode will result in the child restraint not being properly secured. The seat could tip over or otherwise be unsecured and cause injury to the child in a sudden stop or collision.

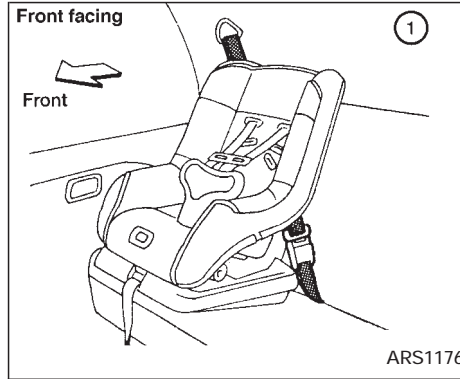

When you install a child restraint in a rear outboard seat, follow these steps:

1. Position the child restraint on the seat. Always follow the restraint manufacturer's instructions.

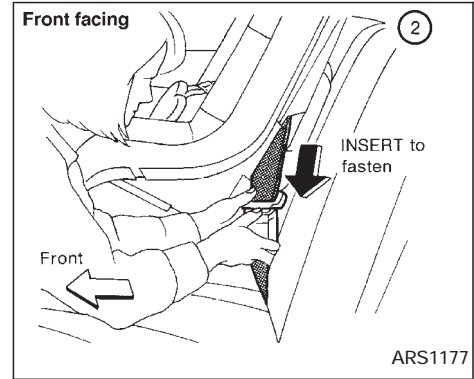

2. Route the seat belt tongue through the child restraint and insert it into the buckle until you hear and feel the latch engage.

Be sure to follow the child restraint manufacturer's instructions for belt routing.

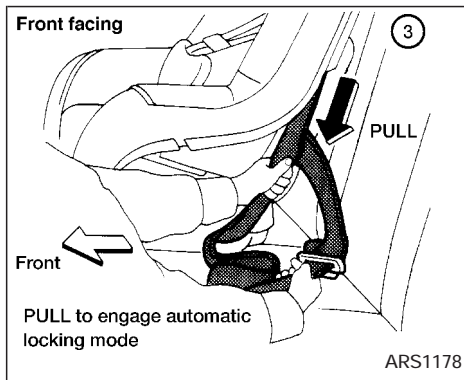

3. Pull on the shoulder belt until all of the belt is fully extended. At this time, the belt retractor is in the automatic locking mode (child restraint mode). It reverts back to emergency locking mode when the belt is fully retracted.

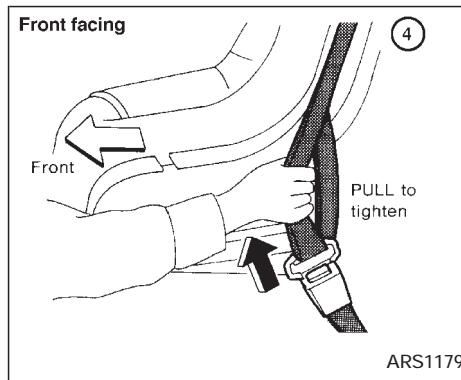

4. Allow the belt to retract. Pull up on the shoulder belt to remove any slack in the belt.

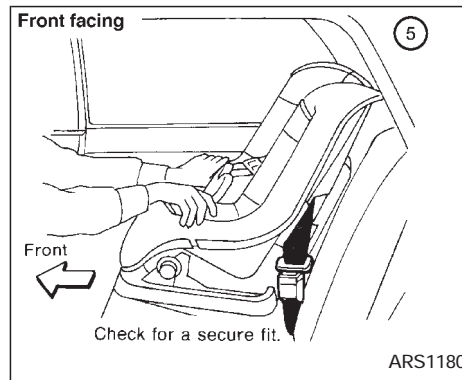

5. Before placing the child in the child restraint, use force to tilt the child restraint from side to side, and tug it forward to make sure it is securely held in place.
6. Check that the retractor is in the automatic locking mode by trying to pull more belt out of the retractor. If you cannot pull any more belt webbing out of the retractor, the belt is in the automatic locking mode.
7. Check to make sure the child restraint is properly secured prior to each use. If the belt is not locked, repeat steps 3 through 6.

After the child restraint is removed and the seat belt is fully retracted (for the passenger side of the two-passenger bench seat, the auxiliary buckle must also be released), the automatic locking mode (child restraint mode) is canceled.

## REAR FACING INSTALLATION AT SECOND AND THIRD ROW OUTBOARD POSITIONS

The following instructions apply to second row bucket seats, the second row bench seat and the outboard positions of the three-passenger bench seat.



### WARNING

When installing a child restraint in the two-passenger bench seat, if it is placed in the seating position next to the passenger side sliding door, be sure both the auxiliary buckle and main buckle are properly fastened. Failure to do so could increase the chance and/or severity of injury in an accident.



### WARNING

- The three-point belt in your vehicle is equipped with an automatic locking mode retractor which must be used when installing a child restraint.

- Failure to use the retractor's locking mode will result in the child restraint not being properly secured. The seat could tip over or otherwise be unsecured and cause injury to the child in a sudden stop or collision.

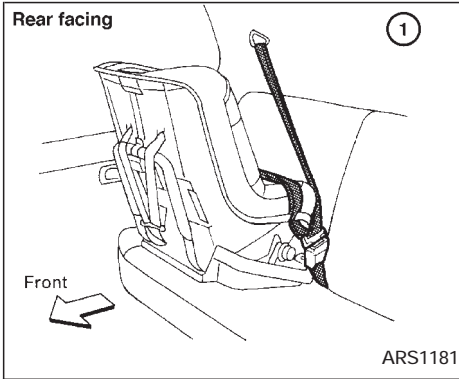

When you install a child restraint in a rear outboard seat, follow these steps:

1. Position the child restraint on the seat. Always follow the restraint manufacturer's instructions.

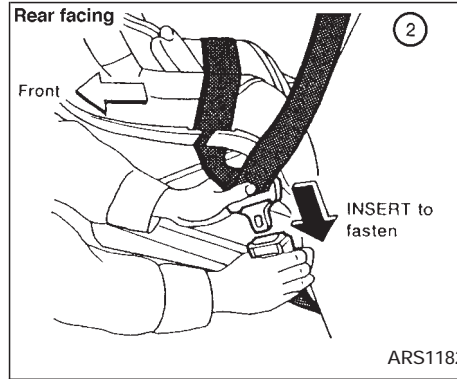

2. Route the seat belt tongue through the child restraint and insert it into the buckle until you hear and feel the latch engage. Be sure to follow the child restraint manufacturer's instructions for belt routing.

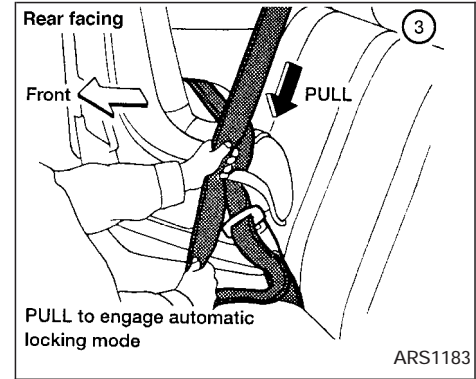

3. Pull on the shoulder belt until all of the belt is fully extended. At this time, the belt retractor is in the automatic locking mode (child restraint mode). It reverts back to emergency locking mode when the belt is fully retracted.



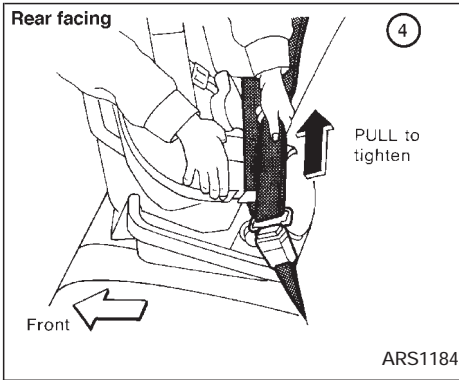

4. Allow the belt to retract. Pull up on the shoulder belt to remove any slack in the belt.

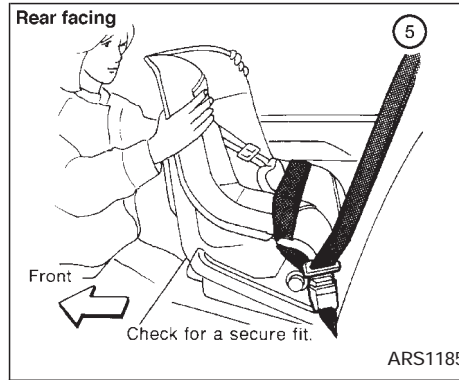

5. Before placing the child in the child restraint, use force to tilt the child restraint from side to side, and tug it forward to make sure it is securely held in place.
6. Check that the retractor is in the automatic locking mode by trying to pull more belt out of the retractor. If you cannot pull any more belt webbing out of the retractor, the belt is in the automatic locking mode.
7. Check to make sure the child restraint is properly secured prior to each use. If the belt is not locked, repeat steps 3 through 6.

After the child restraint is removed and the seat belt is fully retracted (for the passenger side of the two-passenger bench seat, the auxiliary buckle must also be released), the automatic locking mode (child restraint mode) is canceled.

## CHILD RESTRAINT WITH TOP TETHER STRAP

A child restraint anchored with a top tether strap can be installed on the second row bench seat, second row bucket seat, or three-passenger bench seat in the second or third row. The chart indicates where the tether strap must be attached and the section of this manual that contains the instructions for tethering.

Seat type	Position	Tether to	Reference
Bucket seat	Second row; center of seat	Anchor bracket on back of bucket seat	Page 1-52, Tethering to second row bench or bucket seat
Two passenger bench seat	Second row; outboard seating positions	Anchor bracket on back of second row bench seat	Page 1-52, Tethering to second row bench or bucket seat
Two-passenger bench seat with integrated child safety seat	Second row; driver side seating position	Anchor bracket on back of second row bench seat	Page 1-52, Tethering to second row bench or bucket seat
Two-passenger bench seat with integrated child safety seat	Second row; passenger side seating position	<b>CANNOT BE TETHERED</b>	—
Three-passenger bench seat	Second row; outboard seating position	Tongue of third row lap/shoulder belt directly behind the child seat position	Page 1-54, Tethering to lap/shoulder belt tongue
Three-passenger bench seat	Second row; center seating position	<b>CANNOT BE TETHERED</b>	—
Three-passenger bench seat	Third row; outboard or center seating position	*Floor anchor directly behind child seat position	Page 1-56, Tethering to floor

\* The parcel shelf (if so equipped) must be removed prior to tethering the child seat.

## INSTALLATION ON SECOND ROW BENCH OR BUCKET SEAT

A child restraint with a top tether strap may be placed on the second row bench or bucket seats. Once the child restraint is properly secured to the seat (see “Front facing installation at second and third row outboard positions” earlier in this section), follow the directions to attach the tether strap to the tether strap anchor bracket, or the third row lap/shoulder belt tongue (located on the same side of the vehicle as the child restraint).

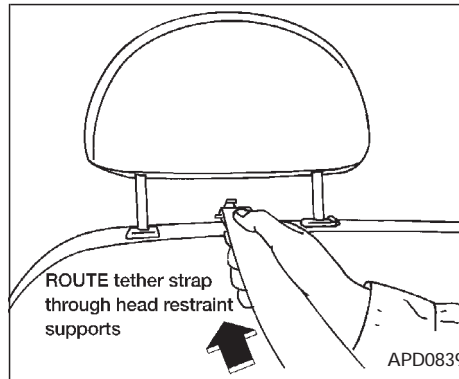

the center of the head restraint through to the back side of the seat.

### Tethering to second row bench or bucket seat

To attach a tether strap to a second row bench or bucket seat:

1. Route the tether strap under the head restraint and between the head restraint supports.
- The head restraint on the second row bucket seat with the integrated child seat is not adjustable, but there is an opening under the head restraint to route the tether strap through. Gently lift the head restraint and route the tether strap under

**Second row bucket seat**

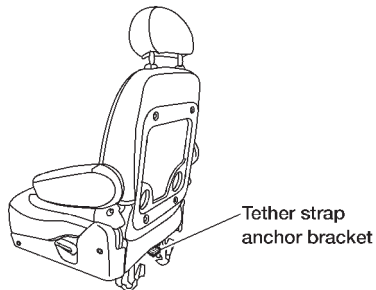

ARS1194

**Second row bench seat**

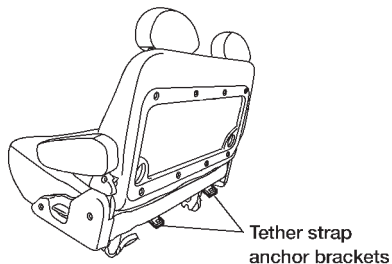

ARS1193

**Second row bench seat with integrated child safety seat**

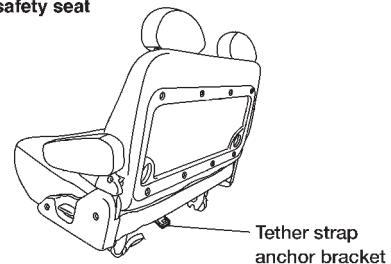

ARS1199

2. Hook the tether strap into the slot in the anchor bracket on the second row seat (located on the lower back of the seat, in line with the head restraint).

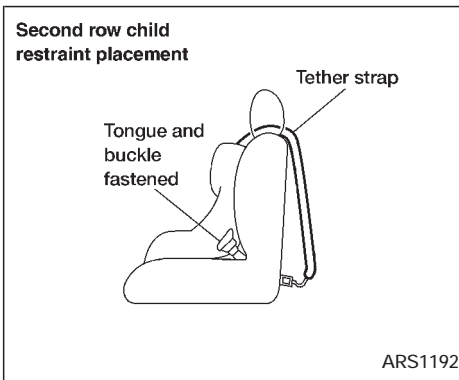

3. Tighten the tether strap to remove any slack.
4. Before placing the child in the child restraint, use force to tilt the child restraint from side to side, and tug it forward to make sure it is securely held in place.
5. Check to make sure the child restraint is properly secured prior to each use. If not secure, repeat steps two through four.

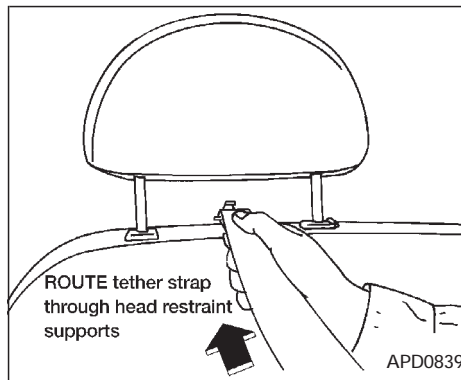

### INSTALLATION ON THREE-PASSENGER BENCH SEAT IN SECOND ROW

#### **⚠ WARNING**

**A third seat occupant should never sit at a seating location where the lap/shoulder belt is being used to attach the child seat. Occupants should sit at locations where seat belts can be used. Remember to always wear your seat belt.**

A child restraint with a top tether strap may be placed at the outboard positions on the three-passenger bench seat when the bench seat is in the second row location. Once the child restraint is properly secured to the seat (see “Front facing installation at second and third row outboard positions” earlier in this section), follow the directions to attach the tether strap to the third row lap/shoulder belt tongue (located on the same side of the vehicle as the child restraint).

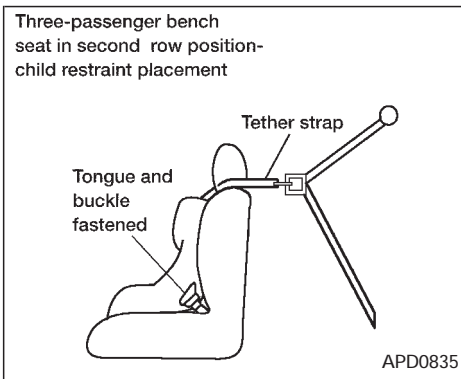

### Tethering to lap/shoulder belt tongue

To attach a tether strap to a third row lap/shoulder belt:

1. Route the tether strap under the head restraint and between the head restraint supports.
2. Hook the tether strap into the large hole on the tongue of the third row lap/shoulder belt (located near the upper and lower rear corners of the vehicle).
3. Adjust the tether strap until the hook is about one foot behind the seatback.

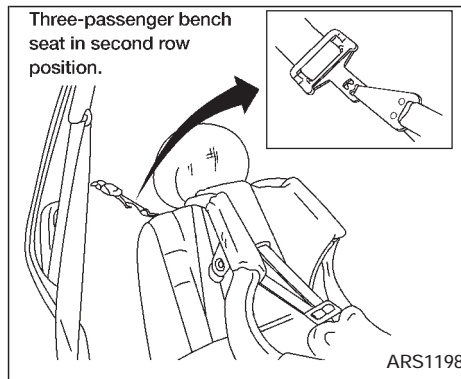

4. Pull on the third row shoulder belt until all of the belt is fully extended. At this time, the belt retractor is in the automatic locking mode (child restraint mode).
5. Allow the belt to retract. Tighten the tether strap to remove any slack.
6. Before placing the child in the child restraint, use force to tilt the child restraint from side to side, and tug it forward to make sure it is securely held in place.
7. Check that the retractor is in the automatic locking mode by trying to pull more belt out of the retractor. If you cannot pull any

more belt webbing out of the retractor, the belt is in the automatic locking mode.

8. Check to make sure the child restraint is properly secured prior to each use. If the belt is not locking, repeat steps 4 through 7.

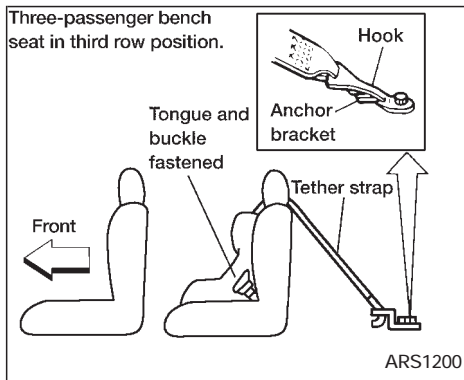

## INSTALLATION ON THREE-PASSENGER BENCH SEAT IN THIRD ROW

A child restraint with a top tether strap may be placed on the three-passenger bench seat when the bench seat is in the third row location. Once the child restraint is properly secured to the seat (see “Front facing installation at second and third row outboard positions” or “Front facing installation at three-passenger bench seat center position” earlier in this section), follow the directions to attach the tether strap to one of the anchor point locations.

1-56 **Seats, restraints and supplemental air bag systems**

## Tethering to floor

When installing a child restraint on the three-passenger bench seat in the third row position, first install the floor anchor bracket (available at an authorized NISSAN dealer) to the provided anchor point.

### Bracket part #88894-89900

To gain access to an anchor point, cut along the perforated floor carpeting of the cargo area.

Installing the anchor bracket requires removing the bolt already installed at the anchor point and using a metric bolt of the dimensions listed below:

**Bolt diameter: 8.0 mm**

**Bolt length: at least 1.18 in (30 mm)**

**Thread pitch: 1.25 mm**

### **⚠ WARNING**

- **Bolts should be installed at all times to prevent the possibility of exhaust fumes entering the passenger compartment through the holes.**

- **Child restraint anchor points are designed to withstand only those loads imposed by correctly fitted child restraints. Under no circumstances are they to be used for adult seat belts or harnesses.**
- **The parcel shelf (if so equipped) must be removed from the vehicle if installing a child restraint on the three-passenger bench seat that requires the use of a top tether strap that is anchored to the vehicle floor. Failure to remove the parcel shelf can increase the severity of injury to the child in an accident.**

Latch the tether strap hook onto the appropriate anchor bracket. The tether strap should be secured to the floor anchor bracket which provides the straightest installation.

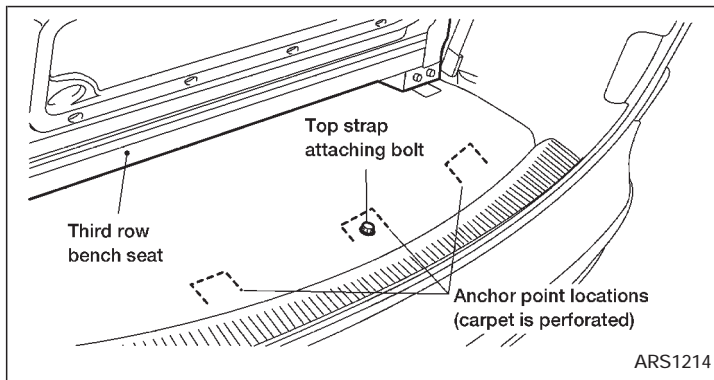

## Anchor point locations

Anchor point attaching bolts are located under the carpet of the rear luggage area floor.

### WARNING

The anchor bolt should be installed at all times to prevent the possibility of exhaust fumes entering the passenger compartment through the holes.



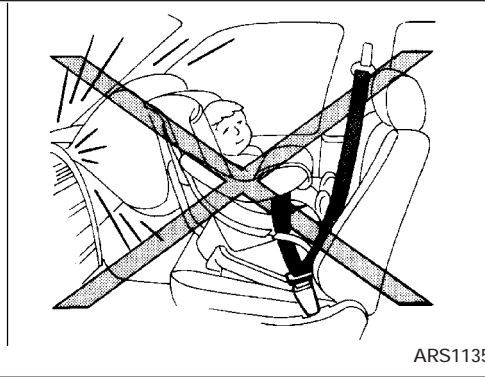
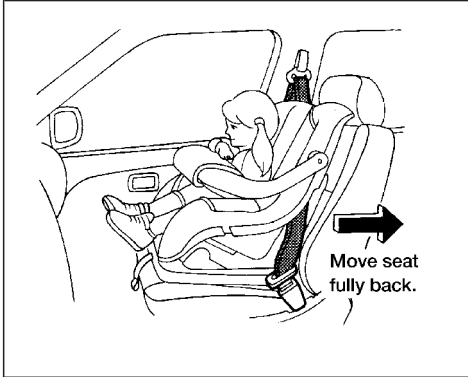

Installation on front passenger seat

**⚠ WARNING**

- Never install a rear-facing child restraint in the front passenger seat. Supplemental air bags inflate with great force. A rear-facing child restraint could be struck by the supplemental air bag in a crash and could seriously injure or kill your child.
- NISSAN recommends that child restraints be installed in the rear seat. However, if you install a forward-

facing child restraint in the front passenger seat, move the passenger seat to the rearmost position.

- A child restraint with a top strap should not be used in the front passenger seat.
- The three-point belt in your vehicle is equipped with an automatic locking mode retractor which must be used when installing a child restraint.

- Failure to use the retractor's locking mode will result in the child restraint not being properly secured. The seat could tip over or otherwise be unsecured and cause injury to the child in a sudden stop or collision.

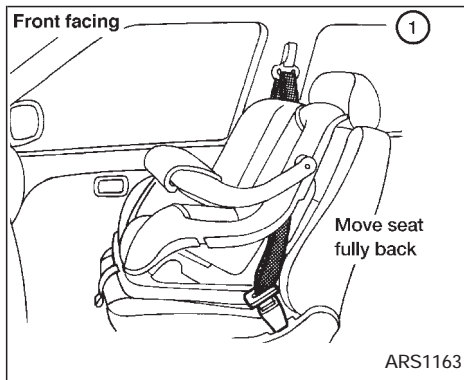

If you must install a child restraint in the front seat, follow these steps:

1. Position the child restraint on the front passenger seat. **It should be placed in a forward-facing direction only.** Move the seat to the rearmost position. Always follow the child restraint manufacturer's instructions. **Child restraints for infants must be used in the rear-facing direction and therefore must not be used in the front seat.**

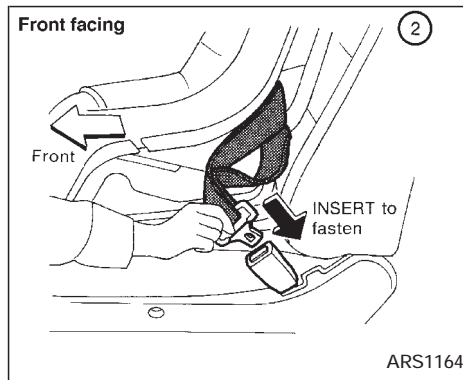

2. Route the seat belt tongue through the child restraint and insert it into the buckle until you hear and feel the latch engage. Be sure to follow the child restraint manufacturer's instructions for belt routing.

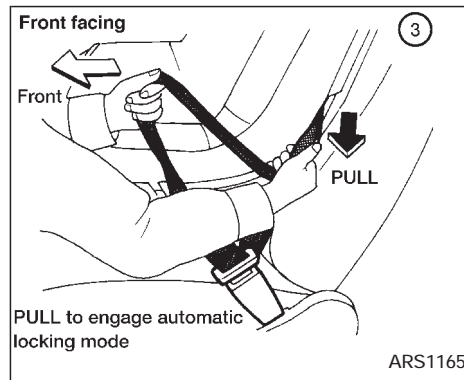

3. Pull on the shoulder belt until all of the belt is fully extended. At this time, the belt retractor is in the automatic locking mode (child restraint mode). It reverts back to emergency locking mode when the belt is fully retracted.

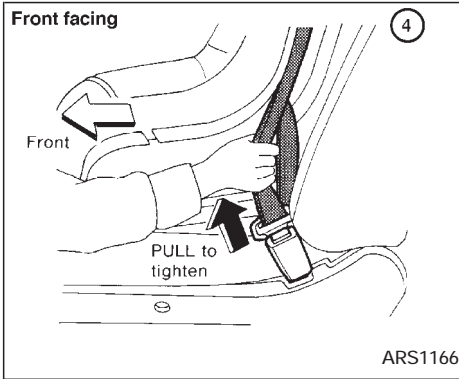

4. Allow the belt to retract. Pull up on the belt to remove any slack in the belt.

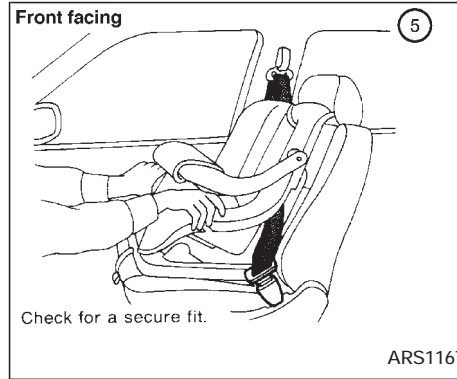

5. Before placing the child in the child restraint, use force to tilt the child restraint from side to side, and tug it forward to make sure it is securely held in place.
6. Check that the retractor is in the automatic locking mode by trying to pull more belt out of the retractor. If you cannot pull any more belt webbing out of the retractor, the belt is in the automatic locking mode.
7. Check to make sure the child restraint is properly secured prior to each use. If the lap belt is not locked, repeat steps 3 through 6.

After the child restraint is removed and the seat belt is fully retracted, the automatic locking mode (child restraint mode) is canceled.

## INTEGRATED CHILD SAFETY SEATS (if so equipped)

### WARNING

- **Failure to follow the instructions for the use of these integrated child safety seats can result in your child striking the vehicle's interior during a sudden stop or crash, causing the injury or death of your child.**
- **Improper use of a child restraint can increase the risk or severity of injury for both the child and other occupants of the vehicle.**

**All U.S. states and Canadian provinces require that infants and small children be restrained in approved child restraints at all times while the vehicle is being operated.**

The optional second row bench seat contains two integrated child safety seats. These seats are designed for use only by children who weigh between 22 and 60 pounds (10-27 kg) and whose height is 45 inches (1145 mm) or less and who are capable of sitting upright alone.

In addition, these integrated child safety seats must only be used by children who meet the following requirements:

- **AGE:**  
At least one year old
- **SEATED HEIGHT:**  
Top of child's shoulders must be below the shoulder harness openings of the integrated child seat.

Children smaller than these requirements should be restrained in an appropriate separate child restraint. Children larger than these requirements should also be restrained in an appropriate separate child restraint or in the appropriate vehicle seat belt system. Refer to "Child Restraints" and "Precautions On Seat Belt Usage" in this section for important child safety information.

### Integrated child safety seat label locations

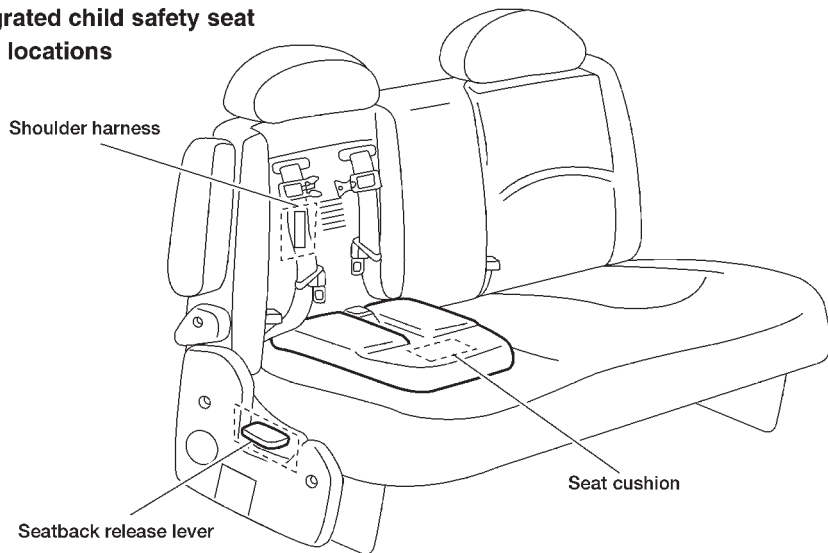

ARS1215

### Using the Integrated Child Safety Seats

#### **WARNING:**

- Never use the vehicle seat belts to restrain a child in an integrated child

safety seat. Use only the shoulder-harness and belt buckle which is part of the integrated child safety seat. Never use the integrated child safety seat as a booster cushion with the vehicle seat belts.

- Before placing the child in the integrated child safety seat, confirm that the bench seatback is securely locked and the seatback release lever is in full down position.
- Always make sure the integrated child safety seat belts are properly positioned on your child. The child should sit straight up and back against the bench seat. The shoulder harnesses should be centered over the shoulders and fastened with the chest clip. The belt buckle should be between the legs and latched to the shoulder belt tongue. Snugly adjust the belts around your child. Failure to properly position the child can increase the risk or severity of injury to the child in an accident.

#### **CAUTION**

Remember that the interior of a closed vehicle can become very hot when left in direct sunlight. Check the seating surface and buckles before placing your child in the integrated child safety seat.

## Securing the child

**Before using the integrated child safety seats, carefully read the shoulder harness, seatback release, and integrated child safety seat cushion labels.**

**The following steps apply to both the left and right integrated child safety seats.**

1. Be sure your child meets all of the required age, weight and height requirements for the safe use of the integrated child safety seat.
2. Be sure the second row bench seat is securely latched to the floor of the vehicle. Refer to “Flexible seating” in this chapter for proper seat installation procedures.
3. Be sure the second row bench seatback is locked by grasping it and trying to rock it back and forth. Also, check that the seatback release lever is in the full down position.

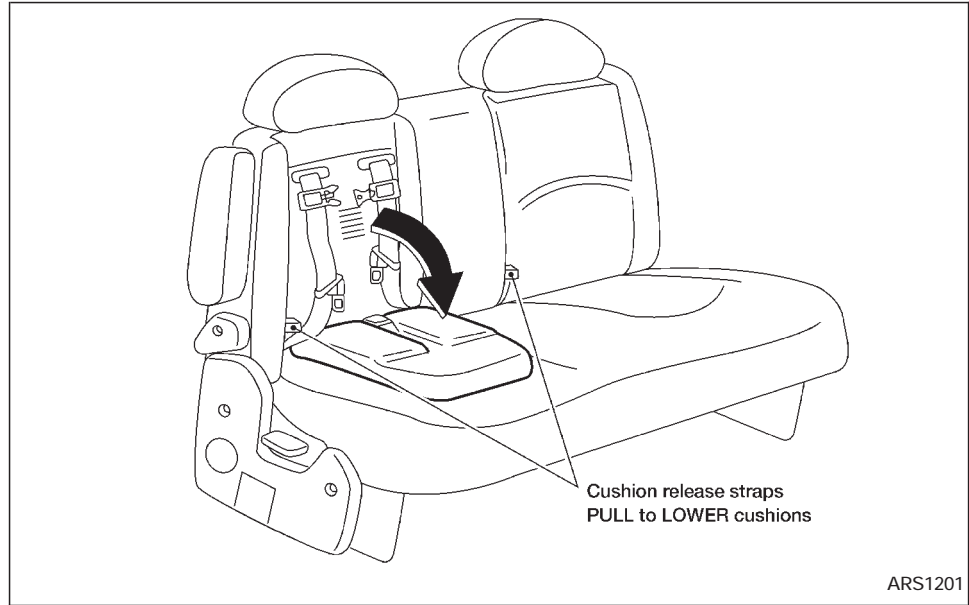

4. Pull the cushion release strap and lower the integrated child safety seat cushion completely.

**NOTE: The head restraints on the passenger bench seat equipped with the integrated child safety seats, are not adjustable or removable.**

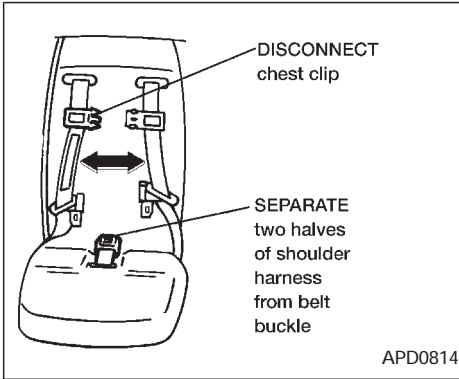

5. If connected, separate the two halves of the shoulder harness from the belt buckle. Also if connected, disconnect the chest clip and lay the shoulder harness halves aside.

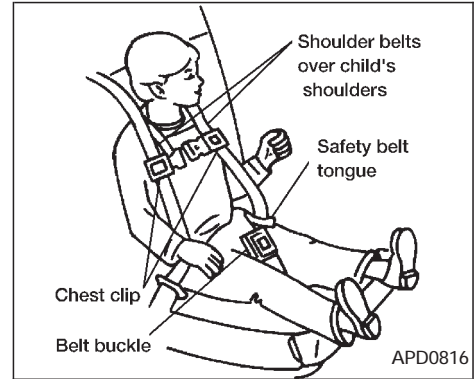
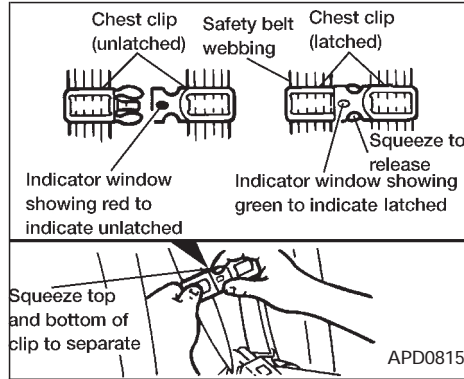

6. Place the child on the integrated child safety seat. Place the belt buckle between the child's legs.

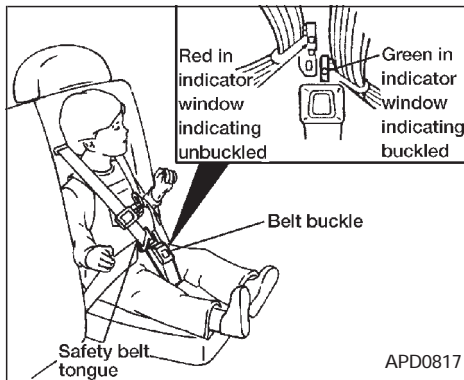

- Place the left shoulder harness over the child's left shoulder. Insert the left shoulder harness tongue into the left side of the belt buckle. Confirm that the left shoulder harness tongue indicator is green. The shoulder harness tongues only fit into the proper sides of the belt buckle.

- Place the right shoulder harness over the child's right shoulder. Insert the right shoulder harness tongue into the right side of the belt buckle. Confirm that the right shoulder harness tongue indicator is green. The shoulder harness tongues only fit into the proper sides of the belt buckle.

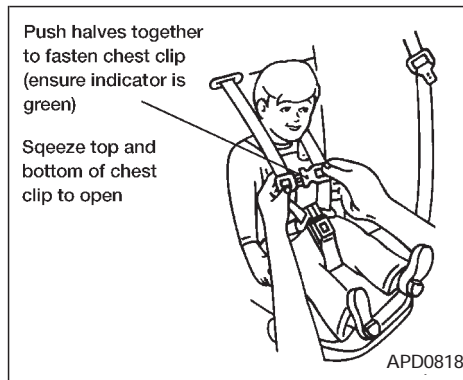

- Fasten the two halves of the chest clip and confirm that the chest clip indicator is green. Adjust the chest clip (slightly lower than the child's shoulders) so it comfortably holds the shoulder harness in position on the child's shoulders.

**⚠ WARNING**

- Shoulder harness tongues and chest clips are equipped with visual indicators to confirm proper and secure latching. For the safety of the child and occupants of the vehicle, all indi-**

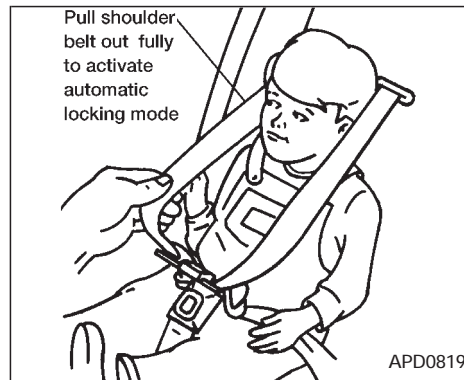

**cators must show green before operating the vehicle.**

- If the shoulder harness is unfastened or not fastened properly, the child could be seriously injured.**

- Grasp the right shoulder harness above the chest clip and pull until the harness fully extends and a click is heard. At this time, the harness retractor is in the automatic locking mode (child restraint mode). With the child sitting properly (straight up and back) in the integrated child safety seat, allow the right shoul-



der harness to retract over the right shoulder and securely restrain the child. A clicking sound is heard as the harness retracts, indicating that the retractor is in the automatic locking mode. Be sure the left shoulder harness is also properly positioned over the child's left shoulder.

11. Check that the shoulder harness is in the automatic locking mode by trying to pull the shoulder harness out of the retractor. If you cannot pull any of the shoulder harness webbing out of the retractor, the shoulder harness is in the automatic locking mode. If the shoulder harness is not locked, repeat step 10. If, after repeated attempts, the integrated child safety seat shoulder harness cannot be placed in the automatic locking mode, do not use the integrated child safety seat and have it inspected by an authorized NISSAN dealer.

To cancel the automatic locking mode, unbuckle the chest clip and both shoulder harness tongues. Allow the shoulder harnesses to retract completely. The automatic locking mode is now canceled and the

shoulder harness retractor is in the emergency locking mode.

#### WARNING

**The automatic locking mode (child restraint mode) must be reactivated each time you place a child in the integrated child safety seats.**

In addition to the automatic locking retractors, the integrated child safety seat shoulder harnesses are equipped with emergency locking retractors. The automatic locking mode is best to use, especially for children who need help staying properly positioned in the seat and its harnesses (for example, children who are younger and smaller), because the belts are always locked. In the emergency locking mode, the shoulder belts only lock in a sudden stop or accident, allowing a child more freedom of movement. Use the emergency locking mode only if you judge your child able to remain properly positioned in the integrated child safety seat.

#### Removing the child

1. Release the chest clip.
2. Release the left and right shoulder har-

ness tongues from the belt buckle by pressing the red belt buckle button.

3. Move the left and right shoulder harnesses aside and assist the child from the integrated child safety seat.

#### Storing the Integrated Child Safety Seat

1. Be sure the shoulder harnesses are fully retracted and resting inside the integrated child safety seat recess. It is not necessary to reconnect the shoulder harnesses and belt buckle prior to storing the integrated child safety seat.
2. While holding onto, but not pulling, the cushion release strap, rotate the cushion upward until it fits flush with the second row seat back cushion and locks into position.
3. Be sure the integrated child safety seat is locked in the stowed position by grasping the safety seat cushion and attempting to lower it without pulling the cushion release strap. If the integrated child safety seat is not locked in the stowed position, repeat steps one through three.

## Integrated Child Safety Seat maintenance

- To clean the shoulder harnesses and belt buckle webbing, apply a mild soap solution or any solution recommended for cleaning upholstery or carpets. Then brush the webbing, wipe it with a cloth and allow it to dry in the shade. Do not allow the shoulder harnesses to retract until they are completely dry.
- The integrated child safety seats cloth removable pads may be cleaned with mild soap and water. The cloth removable pads are attached to the seats with fastener strips, and may be easily removed. The pads are machine washable. For best results, machine wash in cold water in the gentle cycle. Tumble dry on low heat. Do not use chlorine bleach, and do not dry clean.

### CAUTION

Failure to follow the washing instructions provided on the cloth removable pads may result in premature wear or damage.

- Periodically inspect the belt and metal components of the integrated child safety seats, such as the buckles, tongues, shoulder harness webbings, and latching indicators. Periodically check the function of the integrated child safety seat shoulder harness retractor functions. If loose parts, deterioration, cuts, frays, malfunctions or other damage to the belt webbings or metal parts are found, see an authorized NISSAN dealer for repairs.

## Inspection after an accident

If your vehicle was involved in an accident, before using the integrated child safety seats, all related components should be inspected for damage by an authorized NISSAN dealer. Damage to the integrated child safety seat or related components must be repaired.

# SEATS/FLOOR MATS

## SEATING ARRANGEMENTS

Many different arrangements for passenger seating or cargo hauling are available as you will see in the following illustrations. The second row seats may be removed and the third row seat may be moved forward to the second row seating position. The second and third row seats have an optional fold-down table-top feature. This offers a variety of uses for the vehicle when moving or stopped.

The illustrations shown reflect the different seating positions available.

**Before you begin to arrange the seats in your vehicle, read all of the cautions and warnings in this chapter, including the following section on the removable floor mats. Also observe any labels that are in the vehicle.**

### WARNING

- **While the vehicle is in motion, passengers should always be seated in a forward facing direction in a seat which is properly secured and adjusted. Seat belts should always be used. Sitting without a seat belt in a seat that is not properly secured in one of the locations shown in this chapter, or in a place without a seat and seat belt can result in personal injury in a sudden stop or collision.**
  - **Do not ride in a moving vehicle when the seatback is reclined. This can be dangerous. The shoulder belt will not be against your body. In an accident, you could be thrown into it and receive neck or other serious injuries. You could also slide under the lap belt and receive serious internal injuries.**
  - **For the most effective protection when the vehicle is in motion, the seat should be upright. Always sit well back in the seat and adjust the seat belt properly.**
- **It is extremely dangerous to ride in a cargo area inside of a vehicle. In a collision, people riding in these areas are more likely to be seriously injured or killed.**
  - **Do not allow people to ride in any area of your vehicle that is not equipped with seats and seat belts.**
  - **Be sure everyone in your vehicle is in a seat and using a seat belt properly.**
  - **Do not place hard items such as coffee mugs or drinking glasses on the tabletop seats when the vehicle is moving. Any item can become a projectile inside a vehicle involved in a collision. To help prevent personal injury, never leave loose items on the fold-down tabletop seats when the vehicle is moving.**

# FLOOR MAT POSITIONING

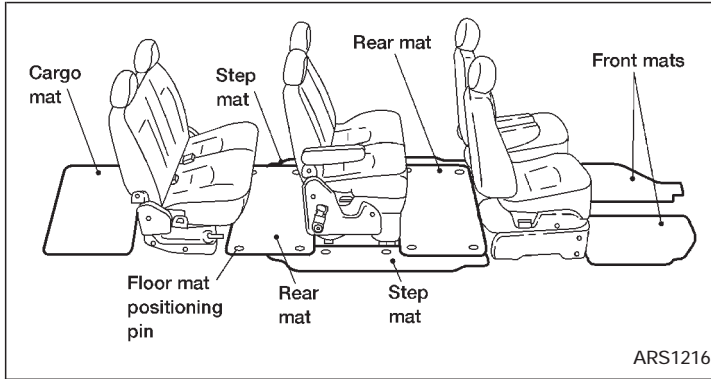

## SEVEN PASSENGER SEATING

### Removable floor mats

Whenever you remove the mats for any reason, the mats must be reinstalled before passengers ride in your vehicle. The floor mats are specifically designed to keep objects out of the seat tracks. The cargo mat is reversible.

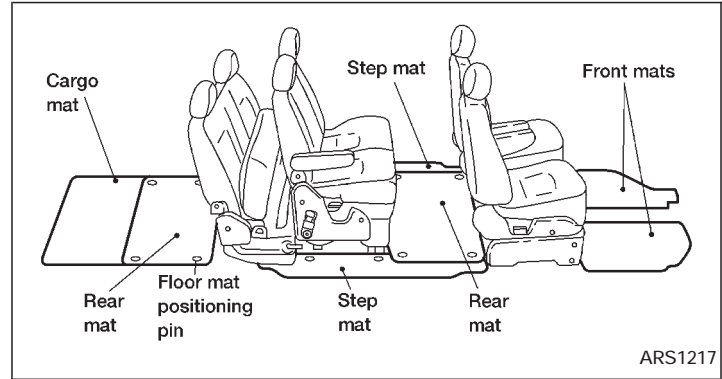

## THREE-PASSENGER BENCH SEAT IN STORAGE POSITION

### **⚠ CAUTION**

**It is important to replace the floor mats whenever they are removed for any reason. The floor mats are intended to help prevent the possibility that high heeled shoes or similar objects might become stuck in the seat tracks. Failure to replace the floor mats might result in personal injury.**

Be sure to keep the seat tracks clear of debris by cleaning them periodically.

Review the following illustrations so you will know the proper way to place the floor mats with the various seating arrangements available in your vehicle.

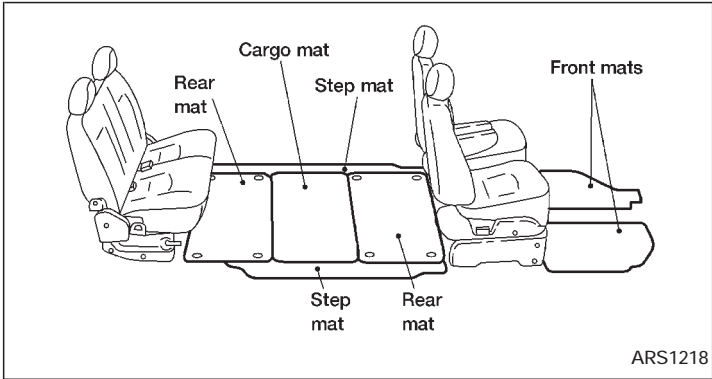

FIVE PASSENGER SEATING

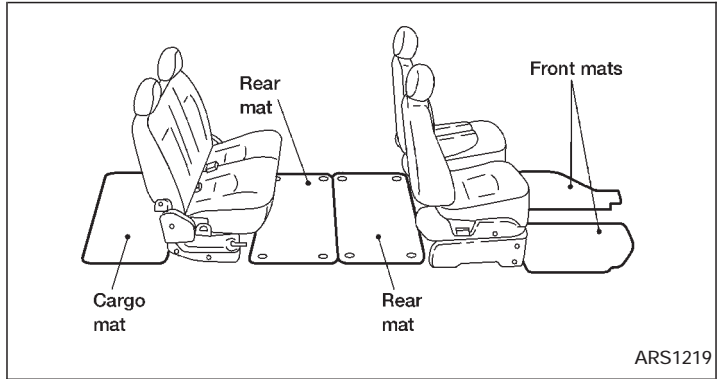

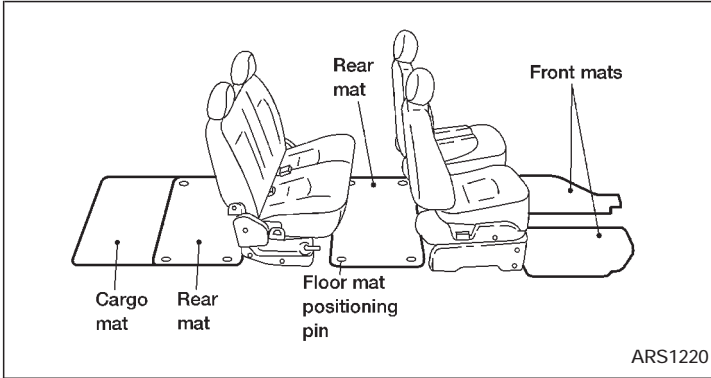

### FIVE PASSENGER SEATING WITH CARGO ROOM

The step mat is not used in this seating configuration.

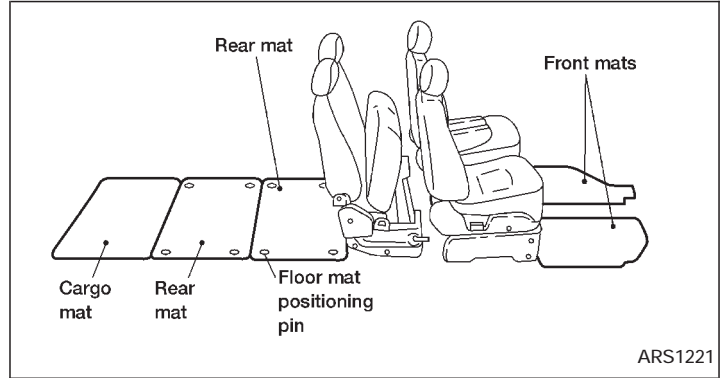

### THREE-PASSENGER BENCH SEAT IN FULLY FORWARD POSITION

The step mat is not used in this seating configuration.

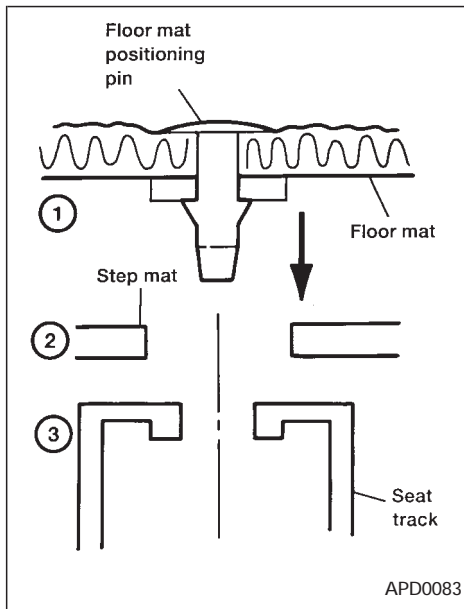

## FLOOR MAT POSITIONING AID

Positioning pins are attached to three of the floor mats. The cargo mat and front mats do not have pins. However, the driver's front floor mat has a grommet which is placed

over the floor mat positioning bracket located at the base of the driver's seat.

Push the positioning pins into the seat tracks to ensure correct installation, then straighten the mats as necessary.

The step mat has holes in addition to pins. When the mats are arranged properly, the positioning pins of the two mats on either side of the step mat should fit through the holes in the step mat and into the seat track.

### **⚠ WARNING**

- No occupant should ride in a vehicle seat unless it is in a normal riding arrangement and the seat belts are properly used.
- It is extremely dangerous to ride in a cargo area inside of a vehicle. In a collision, people riding in these areas are more likely to be seriously injured or killed.
- Properly secure all cargo to help prevent it from sliding or shifting. Do not place cargo higher than the seat-backs. In a sudden stop or collision, unsecured cargo could cause personal injury.

- Do not allow people to ride in any area of the vehicle that is not equipped with seats and seat belts.
- Be sure everyone in your vehicle is in a seat and is using a seat belt properly.
- Failure to follow proper seating instructions in this section could result in serious personal injury in an accident or during a sudden stop.

## SEAT POSITIONS

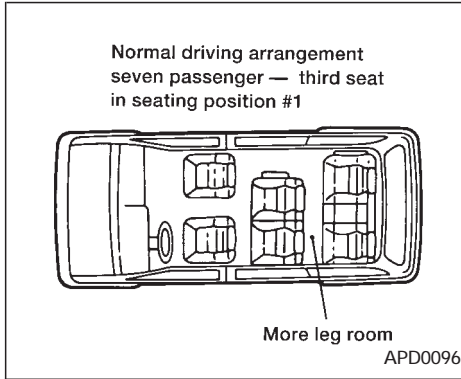

### WITH SECOND ROW BENCH SEAT

The most common seating arrangement for seven passengers is with the three-passenger bench seat in seating position #1. This provides more leg room for the passengers sitting in the third row.

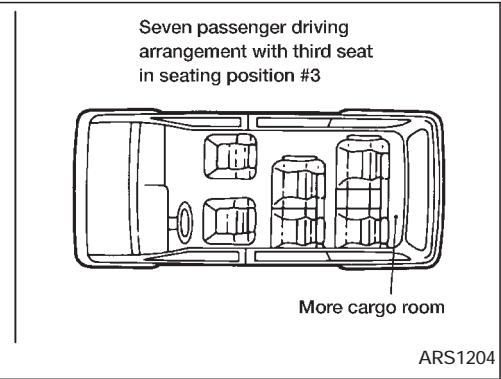
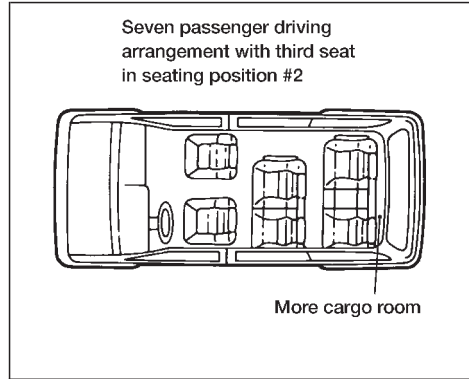

When more cargo area room is necessary, the three-passenger sliding bench seat can be moved to seating position #2 or #3. This seating arrangement provides less leg room for third row passengers, but more cargo room.



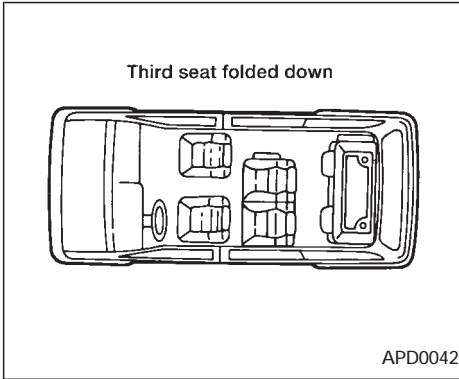

The fold-down tabletop seats in the second and third rows provide a surface for eating or playing games on long trips.

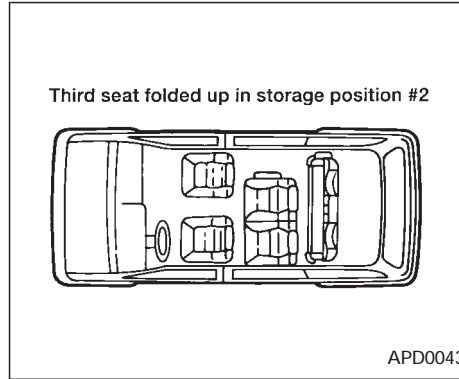

If a considerable amount of cargo area is needed, the seat cushion of the three-passenger sliding bench seat can be flipped up and the seat can be moved up to storage position #2, just behind the second row seat.

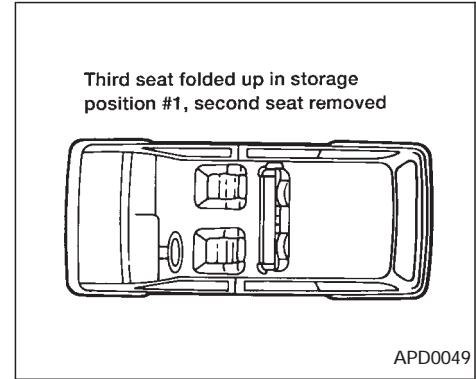

When maximum cargo area is needed and there are no rear seat passengers, the second row seat can be removed and the three-passenger sliding bench seat can be moved up to storage position #1, just behind the front seats.

Second row seat folded down

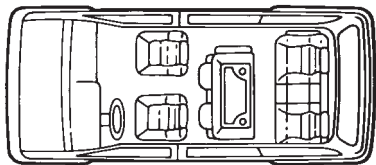

APD0044

The second row bench seat can be folded down to serve as a tabletop for passengers sitting in the three-passenger bench seat.

Second and third row seats folded down

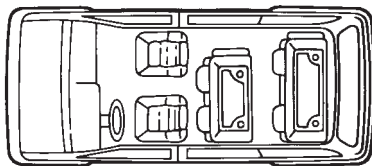

APD0045

The second and third row bench seats can be folded down to tabletops.

Third seat in second position with second row seat removed

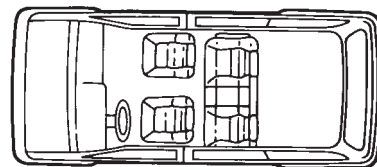

APD0046

To increase cargo area space, the second row bench seat can be removed and the three-passenger sliding seat can be moved up to the second row position.

Third seat folded down in second seating position with second row seat removed

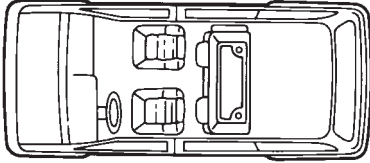

APD0047

The third seat can be folded down into a tabletop.

Second row seat removed, third row seat folded down

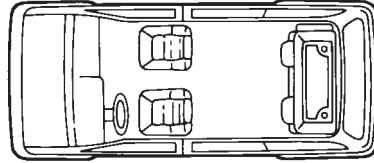

APD0048

With the third seat folded down and the second seat removed, cargo can be placed in between the front seats and the third row seat. **People should not be allowed to ride in areas meant for cargo. Passengers should always be properly restrained in seat belts.**

Second seat folded down, third seat folded up

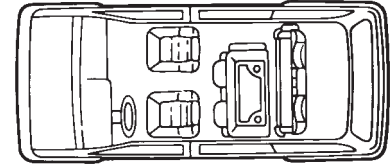

APD0050

The second row seat can be folded down and the third row seat can be moved just behind it in a storage position.

Seven passenger seating with bucket seats in second row — third seat in seating position #1

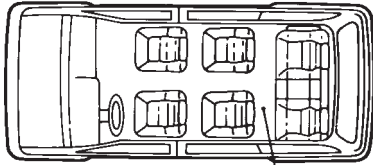

More leg room

APD0128

## WITH SECOND ROW BUCKET SEATS

The normal seating arrangement for seven passengers is with the three-passenger bench seat in seating position #1. This provides more leg room for the passengers sitting in the third row.

One bucket seat removed

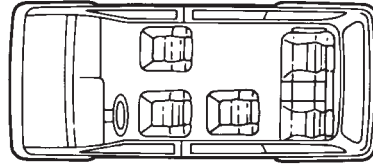

One bucket seat removed

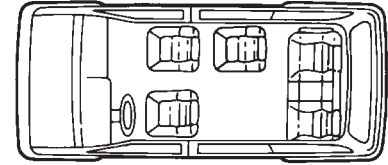

ARS1195

When one passenger in the three-passenger bench seat would like more leg room, one of the second row bucket seats can be removed.

Seven passenger driving arrangement with third seat in seating position #2

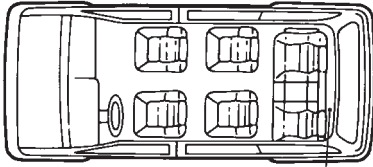

More cargo room

Seven passenger driving arrangement with third seat in seating position #3

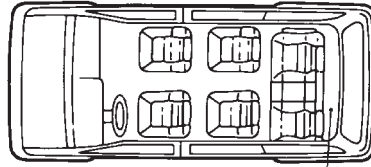

More cargo room

ARS1205

Second row seating removed

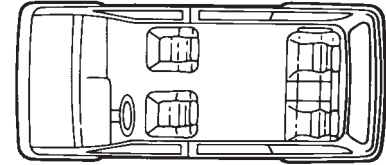

APD0053

When more cargo area room is necessary, the three-passenger sliding bench seat can be moved to seating position #2 or #3. This seating arrangement provides less leg room for third row passengers, but more cargo room.

If passengers in the three-passenger bench seat would like more leg room, both second row bucket seats can be removed. **The floor area should never be used by passengers. Passengers should always be properly restrained by seat belts.**

# 2 Instruments and controls

Meters and gauges .....	2-3	Power windows .....	2-21
Speedometer and odometer .....	2-4	Automatic power window switch .....	2-21
Tachometer .....	2-4	Sunroof (if so equipped).....	2-22
Engine coolant temperature gauge.....	2-4	Manual vent windows.....	2-23
Fuel gauge .....	2-5	Power vent windows (if so equipped).....	2-23
Warning/indicator lights and chimes .....	2-6	Interior lights.....	2-24
Theft warning (if so equipped) .....	2-10	Luggage compartment lights.....	2-24
Windshield wiper and washer switch.....	2-12	Personal reading light .....	2-24
Rear window wiper and washer switches.....	2-13	Map lights.....	2-25
Rear window defogger switch.....	2-13	Illuminated entry system .....	2-25
Headlight control switch.....	2-13	Storage compartment for garage door transmitter (if so equipped) .....	2-25
Daytime running light system (Canada only).....	2-14	Integrated HomeLink® universal transceiver (if so equipped) .....	2-27
Autolamp switch (if so equipped).....	2-14	Programming the HomeLink® universal transceiver .....	2-27
Turn signal switch .....	2-15	Operating the transceiver.....	2-28
Cornering light.....	2-15	Programming problem diagnosis .....	2-28
Instrument brightness control.....	2-16	Rolling codes.....	2-29
Hazard warning flasher switch.....	2-16	Clearing the programming information.....	2-30
Cigarette lighter and ashtray (accessory).....	2-17	If your vehicle is ever stolen .....	2-30
Rear power point.....	2-18		
Cup holder.....	2-18		
Map pockets.....	2-20		
Overhead storage compartment .....	2-20		

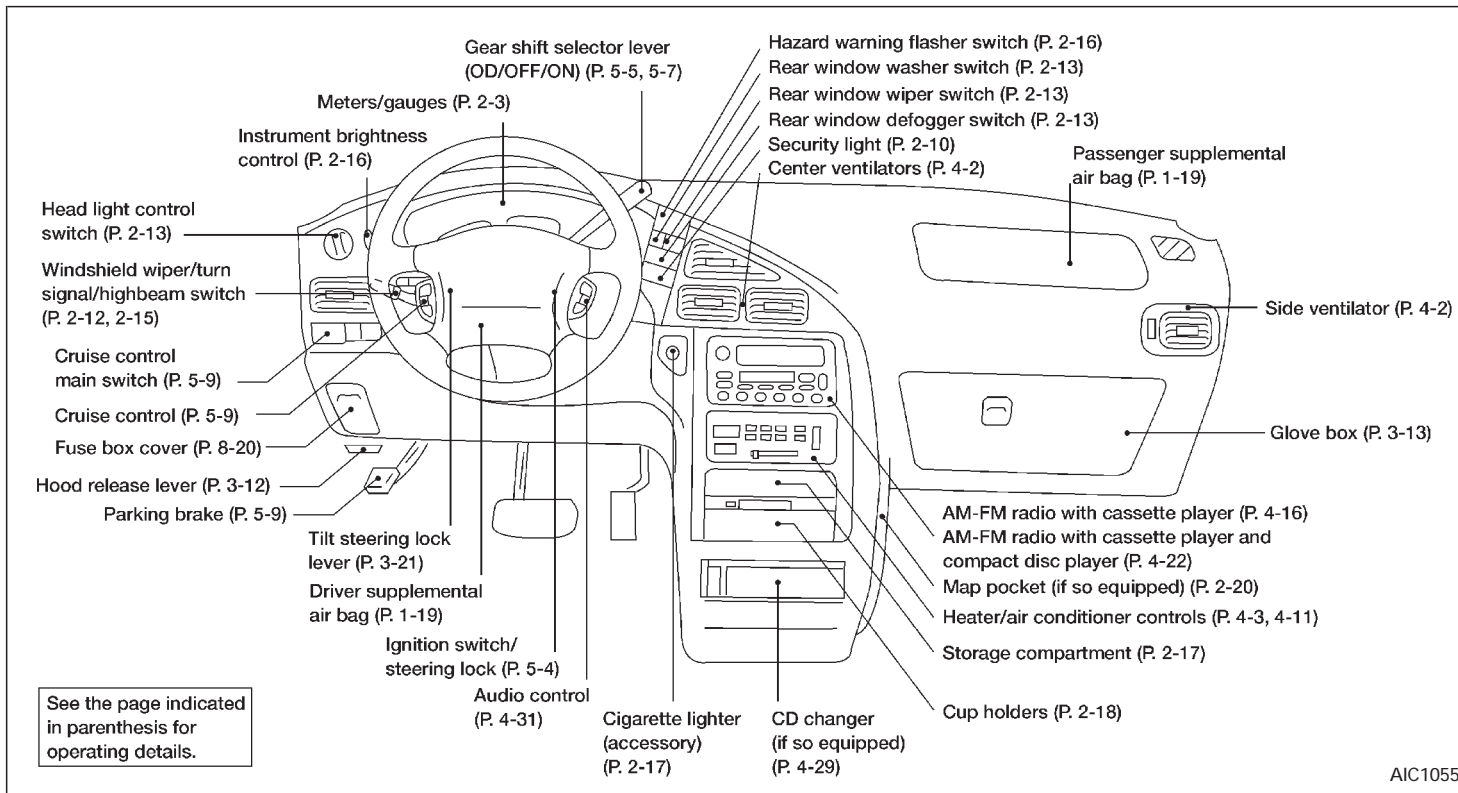

# METERS AND GAUGES

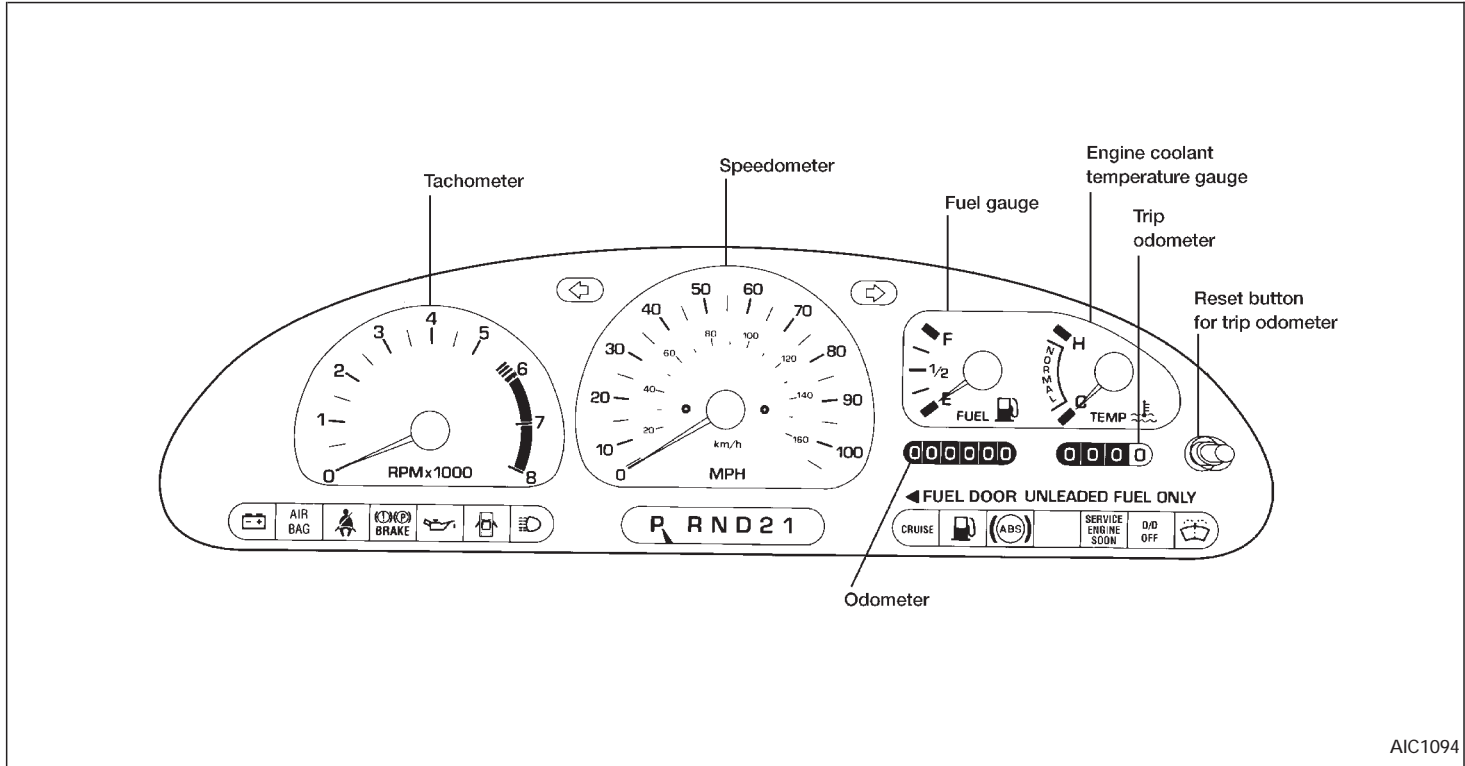

AIC1094



## SPEEDOMETER AND ODOMETER

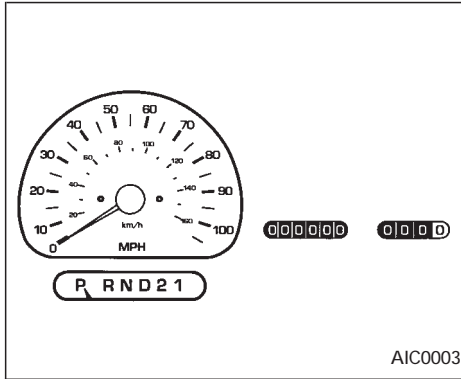

### Speedometer

The speedometer indicates vehicle speed.

### Odometer

The odometer records the total distance the vehicle has been driven.

### Trip odometer

The trip odometer records the distance of individual trips. Before each trip, set the trip odometer to zero by pushing the RESET button.

## TACHOMETER

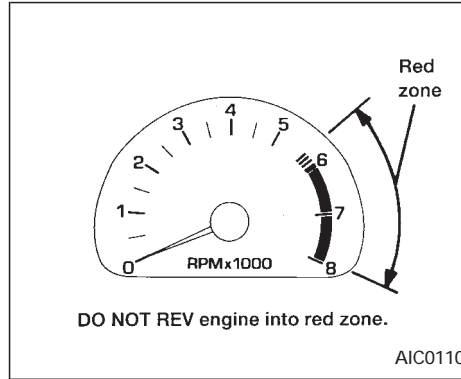

The tachometer indicates engine speed in revolutions per minute (RPM).

### CAUTION

**When engine speed approaches the red zone, shift to a higher gear. Operating the engine in the red zone may cause serious engine damage.**

## ENGINE COOLANT TEMPERATURE GAUGE

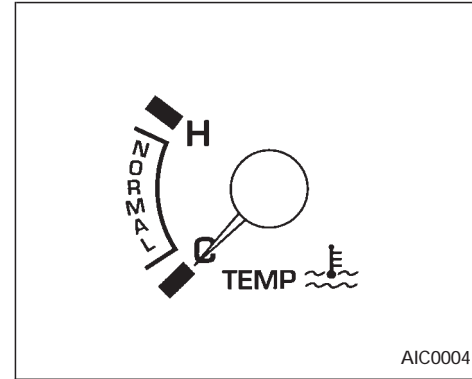

This gauge indicates the engine coolant temperature. The engine coolant temperature varies with the outside air temperature and driving conditions.

### CAUTION

**If the gauge indicates engine coolant temperature above the normal range, stop the vehicle as soon as safely possible. If the engine is overheated, continued operation of the vehicle may seriously damage the engine. See the “In case of emergency” section for immediate action required.**

## FUEL GAUGE

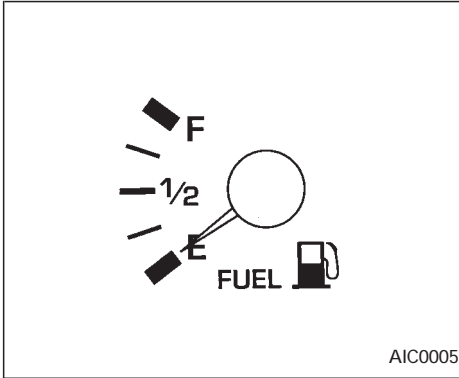

This gauge indicates the **approximate** fuel level in the tank.

The gauge may move slightly during braking, turning, acceleration, or going up or down hills.

The gauge needle remains in approximately the same position even when the ignition key is turned OFF.

The low fuel warning light comes on when the amount of fuel in the tank is getting low.

**Refill the fuel tank before the gauge registers E (empty).**

### CAUTION

- If the vehicle is driven with the fuel level very low, the malfunction indicator light may come on. Refuel as soon as possible. After driving for a while, the light should remain off. If the light remains on, have the vehicle inspected by an authorized NISSAN dealer.

For additional information, see the “Malfunction indicator light (MIL)” later in this section.

# WARNING/INDICATOR LIGHTS AND CHIMES

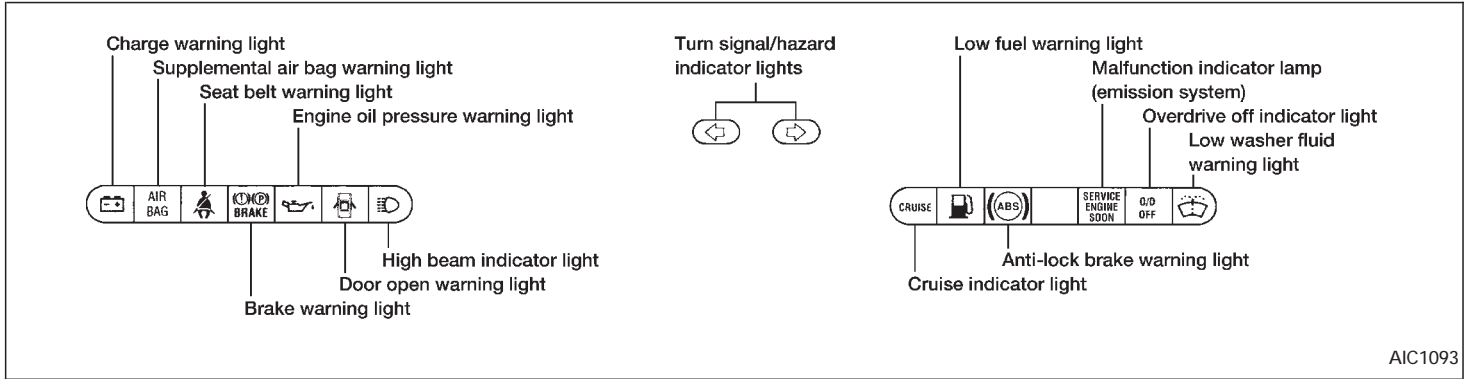

AIC1093

## Checking bulbs

Apply the parking brake, fasten seat belts, and turn the ignition key to ON without starting the engine. The following lights come on and stay on until the engine is started:

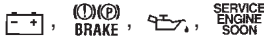

The following lights come on briefly and then go off:

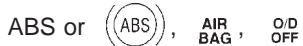

If any light fails to come on, it may indicate a burned-out bulb or an open circuit in the electrical system. Have the

## system repaired promptly.



### Engine oil pressure warning light

This light warns of low engine oil pressure. If the light flickers or comes on during normal driving, pull off the road in a safe area, stop the engine **immediately** and call an authorized NISSAN dealer.

**The oil pressure warning light is not designed to indicate a low oil level. Use the dipstick to check the oil level.** See "Engine oil" in the "Do-it-yourself" section of this manual.

## CAUTION

**Running the engine with the oil pressure warning light on could cause serious damage to the engine almost immediately. Turn off the engine as soon as it is safe to do so.**



### Charge warning light

If the light comes on while the engine is running, it may indicate something wrong with the charging system. Turn the engine off and check the generator belt. If the belt is loose, broken, missing, or if the light re-

mains on, see an authorized NISSAN dealer immediately.

 **CAUTION**

**Do not continue driving if the belt is loose, broken or missing.**



### Low fuel warning light

This light comes on when the fuel level in the fuel tank is getting low. Refuel as soon as it is convenient, preferably before the fuel gauge reaches E (Empty). **There will be a small reserve of fuel in the tank when the fuel gauge needle reaches E (Empty).**



### Door ajar warning light

This light comes on when any of the doors are not closed securely while the ignition key is ON.



### Seat belt warning light and chime

The light and chime remind you to fasten your seat belts. If the driver's seat belt is NOT securely fastened when the ignition key is turned to ON or START, the chime sounds for approximately 6 seconds and the light illuminates.

Refer to "Seat belts" in the "Seats, restraints and supplemental air bag systems" section of this manual for precautions on seat belt usage.



### Supplemental air bag warning light

When the ignition key is in the ON or START position, the supplemental air bag warning light illuminates for about 7 seconds and then turns off. This means the Air Bag Supplemental Restraint System is operational.

If any of the following conditions occur, the supplemental air bag system needs servicing and your vehicle should be taken to an authorized NISSAN dealer:

1. The supplemental air bag warning light does not come on for 7 seconds and then turn off as described above.
2. The supplemental air bag warning light flashes intermittently, or remains on after 7 seconds.
3. The supplemental air bag warning light does not come on at all.

Under these conditions, the Air Bag Supplemental restraint system may not function properly. For additional details, see "Supple-

mental restraint system" in the "Seats, restraints and supplemental air bag systems" section of this manual.

 **WARNING**

**If the supplemental air bag warning light is on, it could mean that the supplemental air bag will not operate in an accident.**



### Low washer fluid warning light

This light comes on when the washer fluid is at a low level. Add washer fluid as necessary. See the "Do-it-yourself" section of this manual.



### Brake warning light

This light functions for both the parking brake and the foot brake systems.

When the ignition key is in the ON position, the light comes on when the parking brake is applied, and also warns of a low brake fluid level. If the light comes on while the engine is running with the parking brake not applied, stop the vehicle and perform the following:

1. Check the brake fluid level. Add brake fluid as necessary. See “Brake fluid” in the “Do-it-yourself” section of this manual.
2. If the brake fluid level is correct, have the warning system checked by an authorized NISSAN dealer.

**⚠ WARNING**

- **Your brake system may not be working properly if the warning light is on. Driving could be dangerous. If you judge it to be safe, drive carefully to the nearest service station for repairs. Otherwise, have your vehicle towed.**
- **Pressing the brake pedal with the engine stopped and/or low brake fluid level may increase your stopping distance and braking will require greater pedal effort as well as pedal travel.**
- **If the brake fluid level is below the minimum mark on the brake fluid reservoir, do not drive until the brake system has been checked at an authorized NISSAN dealer.**

**ABS** or **(ABS)** Anti-lock brake warning light

If the light comes on while the engine is running, it may indicate something is wrong with the anti-lock portion of the brake system. Have the system checked by an authorized NISSAN dealer.

If a malfunction occurs in the system, the anti-lock function turns off, but the brakes continue to operate normally.

**If the light comes on while you are driving, contact an authorized NISSAN dealer for repair.**

**O/D OFF** Overdrive off indicator light

This light comes on during driving when the overdrive switch is pressed to prevent overdrive operation.

The O/D OFF indicator light comes on for two seconds each time the ignition key is turned ON. This shows the light is functioning properly.

If the O/D OFF indicator light blinks for approximately 8 seconds after coming on for 2 seconds, have an authorized NISSAN

dealer check the transmission and repair it if necessary.

The automatic transmission is equipped with an electronic Fail-Safe mode. This system allows the vehicle to be driven even in the event of damage to the electrical circuits. If this occurs, the gears automatically engage and lock into third gear.

NOTE: See “Fail-safe” in the “Starting and driving” section of this manual before visiting an authorized NISSAN dealer.

**↔** Turn signal/hazard indicator lights

The appropriate light flashes when the turn signal lever is activated.

Both lights flash when the hazard switch is turned on.

**☰** High beam indicator light

This light comes on when the headlight high beam is on and goes out when the low beam is selected.

**CRUISE** Cruise indicator light

The light comes on while the vehicle speed is controlled by the cruise control system. If the

CRUISE indicator blinks, have the system checked by an authorized NISSAN dealer.

### Key reminder chime

The chime sounds if the driver's door is opened while the key is left in the ignition switch. Remove the key and take it with you when leaving the vehicle.

### Light reminder chime

A chime sounds when the driver's door is opened if the headlight control switch is turned on (ignition switch is turned OFF).

The chime will not sound when the Autolamp (if so equipped) shut-off delay is activated. Refer to the "Autolamp Switch" instructions later in this section.

Turn the headlight control switch to OFF when you leave the vehicle.

### Brake pad wear warning

The disc brake pads have audible wear warnings. When a brake pad requires replacement, it makes a high pitched scraping sound when the vehicle is in motion whether or not the brake pedal is depressed. Have the brakes checked as soon as possible if the warning sound is heard.



### Malfunction indicator light (MIL)

If the malfunction indicator light comes on steady or blinks while the engine is running, it may indicate a potential emission control problem.

The malfunction indicator light may also come on steady or blink if the fuel filler cap has not been closed tightly or if the fuel tank is nearly empty. Check to make sure the fuel cap is secure and that you have at least three gallons (14 liters) of fuel in the fuel tank.

After driving for a while, the light should remain off if no other potential emission control system problem exists.

### Operation

The malfunction indicator light will come on in one of two ways:

- Malfunction indicator light on steady - An emission control system malfunction has been detected. Have the vehicle inspected by an authorized NISSAN dealer. You do not need to have your vehicle towed to the dealer.

- Malfunction indicator light blinking - An engine misfire has been detected which may damage the emission control system. To reduce or avoid emission control system damage:
  - a) do not drive at speeds above 45 MPH (72 km/h).
  - b) avoid hard acceleration or deceleration.
  - c) avoid steep uphill grades.
  - d) if possible, reduce the amount of cargo being hauled or towed.

The malfunction indicator light may stop blinking and come on steady. Have the vehicle inspected by an authorized NISSAN dealer. You do not need to have your vehicle towed to the dealer.



### CAUTION

**Continued vehicle operation without having the emission control system checked and repaired as necessary could lead to poor driveability, reduced fuel economy, and possible damage to the emission control system.**

## THEFT WARNING (if so equipped)



The theft warning system provides audio and visual alarm signals if parts of the vehicle are disturbed.

### How to activate the theft warning system

1. Close all windows.
2. Remove the key from the ignition switch.
3. Close all doors and the hood.
4. Push the  button on the multi-remote controller. All doors lock. The hazard lights flash twice and the horn beeps once to indicate all doors are locked.

- When the  button is pushed with all doors locked, the hazard lights flash twice and the horn beeps once as a reminder that the doors are already locked.

The horn may or may not beep once. Refer to “silencing the horn beep feature” later in this section.

**The system can be activated even if the windows are open.**

5. Confirm that the SECURITY indicator light comes on. The SECURITY light glows for about 30 seconds and then begins to flash once every three seconds. The system is now activated. If, during this 30-second time period, the door is unlocked by the key or the multi-remote controller, or the ignition key is turned to ACC or ON, the system will not activate.

**If the key is turned slowly when locking the door, the system may not activate. Furthermore, if the key is turned excessively to the unlock position, the system may be deactivated when the key is removed. If the indicator light fails to glow for 30 seconds, unlock the door once and lock it again.**

**Even when the driver and/or passengers are in the vehicle, the system will activate with all doors, hood and trunk lid locked and ignition key off. Turn the ignition key to ACC or ON to turn the system off.**

### Theft warning system operation

The theft warning system emits the following alarm:

- The headlights and tail lights flash and the horn sounds intermittently. In addition, the starter motor does not operate.
- The alarm automatically turns off after two to three minutes. However, the alarm reactivates if the vehicle is tampered with again. The alarm can be shut off by unlocking a door with the key or by pressing the  button on the multi-remote controller.

The alarm is activated when:

- a door is unlocked or opened without using the key or the multi-remote controller. This includes unlocking the doors with the inside door lock switch.
- the hood is opened.

- the ignition is placed into the ACC, ON, or START position without the key in the ignition.

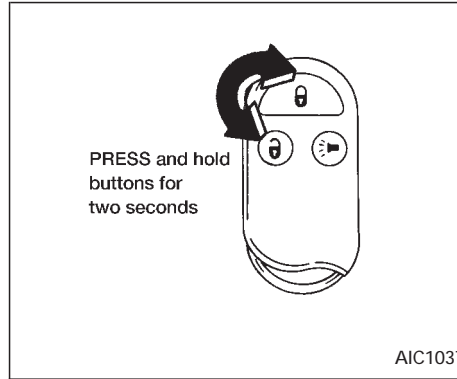

## How to stop the alarm

The alarm stops only by unlocking a door with the key or by pressing the  button on the multi-remote controller. The alarm does not stop if the ignition key is turned to the ACC or ON position.





## Silencing the horn beep feature

If desired, the horn beep feature can be deactivated using the multi-remote controller. The instructions are on the back of the multi-remote controller.

**To deactivate:** Press and hold the  and  buttons **for at least two seconds**.

The hazard lights will quickly flash three times to confirm that the horn beep feature has been deactivated.

**To activate:** Press and hold the  and  buttons **for at least two seconds once more**.

The hazard lights will quickly flash three times to confirm that the horn beep feature has been reactivated.

Deactivating the horn feature does not silence the horn if the alarm is triggered.

**If the system does not operate as described above, have it checked by an authorized NISSAN dealer.**



## WINDSHIELD WIPER AND WASHER SWITCH

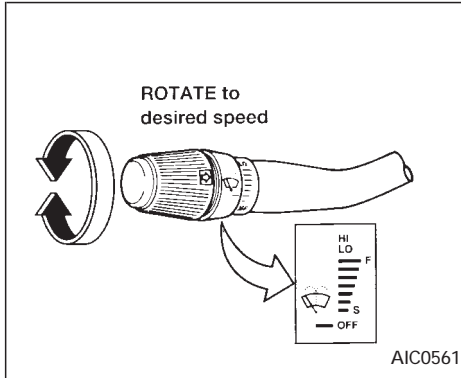

To operate the wipers intermittently, adjust the knob between the S (slow) and F (fast) positions. For continuous operation, select LO or HI.

To operate the washer, press on the end of the wiper knob. For more washer fluid, push and hold the end of the wiper knob. The wipers cycle a few times when the washer is activated. The washer operates in any of the wiper positions.

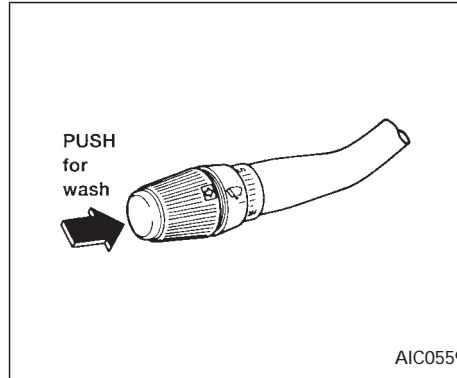

and obscure your vision, which may lead to an accident. Warm the windshield with the defroster before you wash the windshield.

### CAUTION

The following could damage the washer system:

- Do not operate the washer continuously for more than 30 seconds.
- Do not operate the washer if the reservoir tank is empty.

### WARNING

In freezing temperatures the washer solution may freeze on the windshield

## REAR WINDOW WIPER AND WASHER SWITCHES

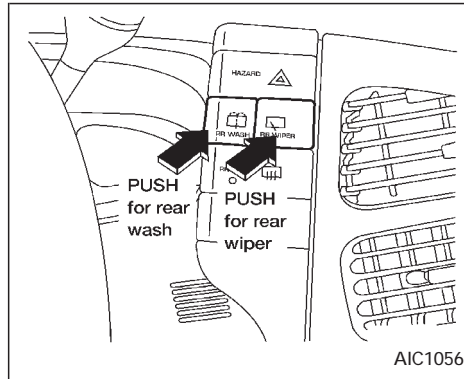

Push and hold the rear washer switch to operate the rear washer. The wiper cycles continuously until the switch is released.

Push the rear wiper switch to operate the wiper. The wiper cycles intermittently. Push again to cancel.

### CAUTION

- Do not operate the washer continuously for more than 30 seconds.
- Do not operate the washer if the reservoir tank is empty.

## REAR WINDOW DEFOGGER SWITCH

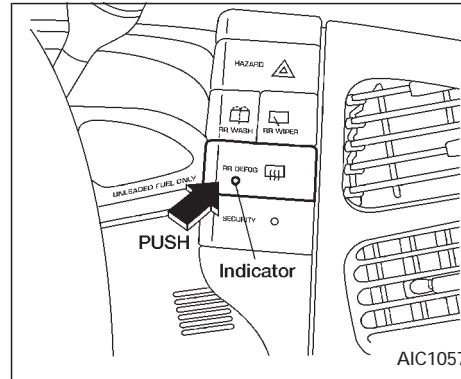

To defog the rear window glass, start the engine and push the switch on. The indicator light on the switch comes on. Push the switch again to turn the defogger off.

The rear window defogger switch is also used to defrost, defog, or de-ice the power outside heated mirrors (if so equipped).

It automatically turns off in approximately 15 minutes.

### CAUTION

**When cleaning the inner side of the window, be careful not to scratch or damage the rear window defogger.**

## HEADLIGHT CONTROL SWITCH

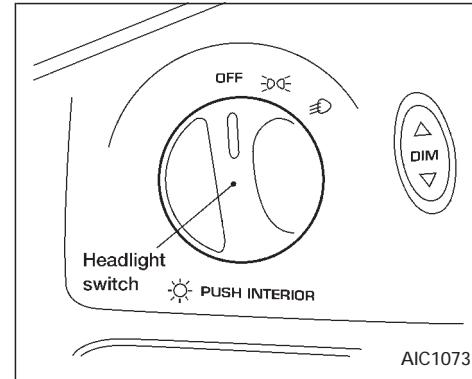

## Lighting

Turn the dial to the  position:

The front parking, side marker, tail, license plate and instrument lights come on.

Turn the dial to the  position:

Headlights come on and all of the previously listed lights remain on.

To select the high beam, push the turn signal lever away from you. The lever latches in place. Pull it back to select the low beam.

To turn the interior lights on push the headlight switch. The interior lights come on.

## AUTOLAMP SWITCH (if so equipped)

Push the headlight switch again to turn the interior lights off.

### DAYTIME RUNNING LIGHT SYSTEM (Canada only)

The headlights automatically illuminate at a reduced intensity when the engine is started with the parking brake released. The daytime running lights operate with the headlight switch in the OFF position or in the  $\text{D}\text{D}\text{D}$  position. Turn the headlight switch to the  $\text{D}$  position for full illumination when driving at night.

If the parking brake is applied before the engine is started, the daytime running lights do not illuminate. The daytime running lights illuminate once the parking brake is released. The daytime running lights will remain on until the ignition switch is turned OFF.

#### WARNING

**When the daytime running light system is active, tail lights on your vehicle will not be on. It is necessary at dusk to turn on your headlights. Failure to do so could cause an accident injuring yourself and others.**

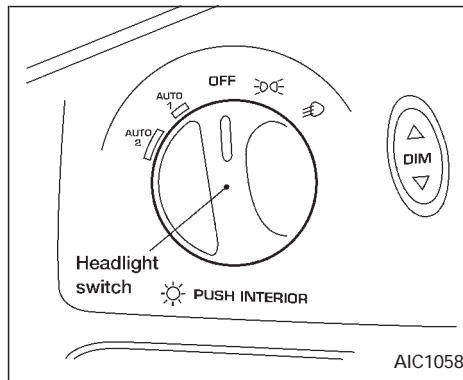

The autolamp system allows the headlights to be set so they turn on and off automatically. The autolamp system can turn on the headlights automatically when it is dark, turn off the headlights when it is light, and keep the headlights on for up to three minutes after you turn the key to OFF.

To set the autolamp system:

1. Make sure the headlight switch is in the AUTO1 or AUTO2 position.
2. Turn the ignition key to ON.
3. The autolamp system automatically turns the headlights on and off.

### Shut-off delay

The length of time the headlights stay on after the ignition is turned to OFF depends on whether the switch is in the AUTO1 or AUTO2 position. If the switch is in the AUTO1 position, then the headlights stay on for less than 1 minute after the ignition is turned OFF. If the switch is in the AUTO2 position, the headlights stay on approximately 3 minutes after the ignition is turned OFF.

To turn the autolamp system off, turn the switch to the OFF,  $\text{D}\text{D}\text{D}$ , or  $\text{D}$  position.

## TURN SIGNAL SWITCH

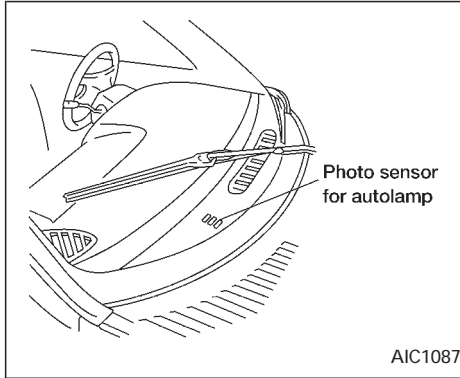

**Be sure you do not put anything on top of the photo sensor located in the top left side of the instrument panel. The photo sensor controls the autolamp; if it is covered, the photo sensor reacts as if it is dark out and the headlights will illuminate.**

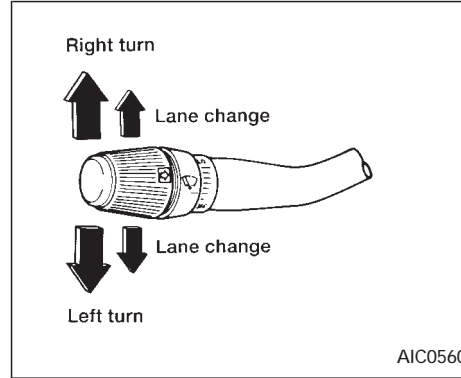

### Turn signal

Move the lever up or down to signal the turning direction. When the turn is completed, the turn signal cancels automatically.

### Lane change signal

To indicate a lane change, move the lever up or down to the point where the light begins to flash, but the lever does not latch.

### Passing signal

Pulling the lever toward you turns the headlight high beam on. Release it and the headlight high beam goes off.

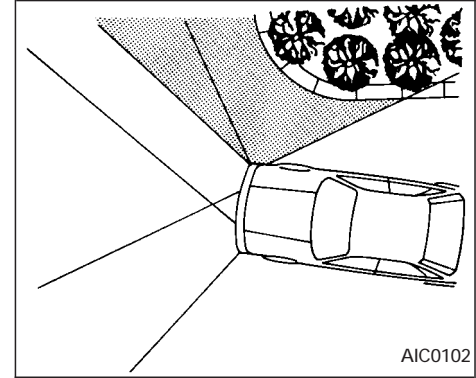

## CORNERING LIGHT



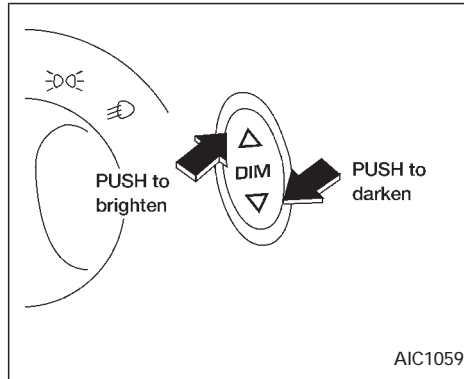

The cornering light provides additional illumination toward the turning direction. The light on the turning direction side comes on when a turn is signaled with the headlights on.

## INSTRUMENT BRIGHTNESS CONTROL



The instrument brightness control operates when the light switch is in the  or  position, or when the autolamp system is operating.

Pressing the  side of the switch brightens the instrument panel lights; pressing the  side of the switch dims the instrument panel lights.

## HAZARD WARNING FLASHER SWITCH

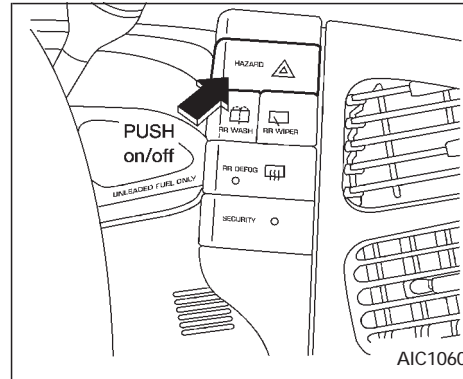

Push the  (hazard) switch to warn other drivers when you must stop or park under emergency conditions. All turn signal lights flash. Press the switch again to turn the hazard warning flashers off.

### WARNING

- **When stalled or stopped on the roadway under emergency conditions, move the vehicle well off the road.**
- **Do not use the switch while moving on the highway unless unusual circumstances force you to drive so**

**slowly that your vehicle might become a hazard to other traffic.**

- **Turn signals do not work when the hazard warning flasher lights are on.**

The flashers can be actuated with the ignition switch either OFF or ON.

**Some state laws may prohibit the use of the hazard warning flasher switch while driving.**

## CIGARETTE LIGHTER AND ASHTRAY (accessory)

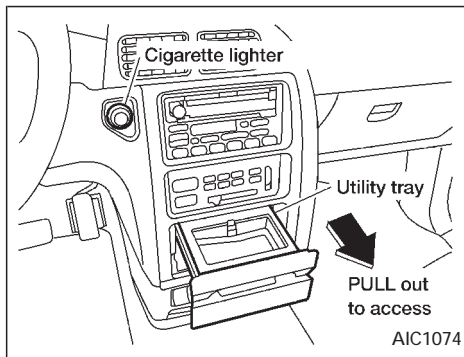

The cigarette lighter element is an accessory. A genuine NISSAN cigarette lighter or equivalent can be purchased from an authorized NISSAN dealer.

The cigarette lighter operates when the ignition switch is in the ACC or ON position.

Push the lighter in all the way. When the lighter is heated, it springs out.

Return the lighter to its original position after use.

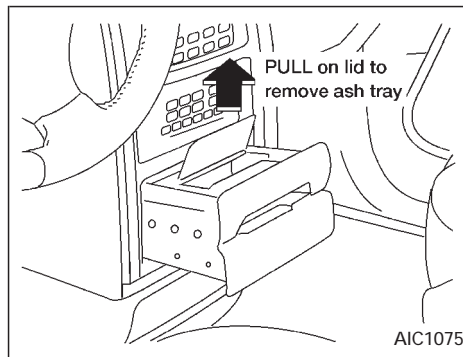

The utility tray has a rubber mat that may be removed for cleaning.

The ashtray is an accessory. A genuine NISSAN ashtray or equivalent can be purchased from an authorized NISSAN dealer.

**The ashtray fits in the utility box. Do not use the utility box as an ashtray. Use only a genuine NISSAN ashtray or equivalent.**

Pull on the lid of the ashtray to remove it for disposing of ashes.

### CAUTION

The cigarette lighter socket is a power source for the cigarette lighter element only. The use of the cigarette lighter socket as a power source for any other accessory is not recommended.

### WARNING

The cigarette lighter should not be used while driving in order that full attention may be given to the driving operation.

## REAR POWER POINT

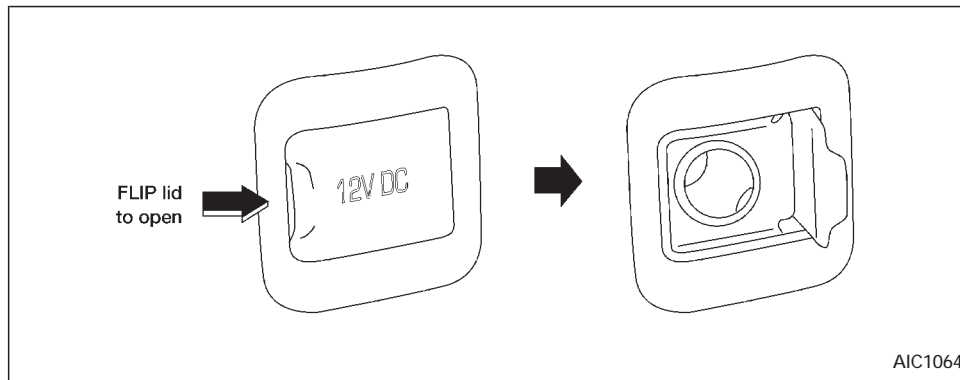

The rear power point is located on the driver's side trim panel of the second row seat behind the side door. Open the cover to gain access to the power point.

Use the power point to plug in electrical equipment such as a cellular telephone, CB radio, etc. Follow the installation instructions included with your electrical equipment.

When not in use, always close the power point cover.

### CAUTION

#### When using the power point:

- **Maximum load of any electrical equipment should not exceed 10 amps.**
- **Be sure to turn off any electrical equipment when not in use. Leaving electrical equipment on for extended periods can discharge your battery.**

## CUP HOLDER

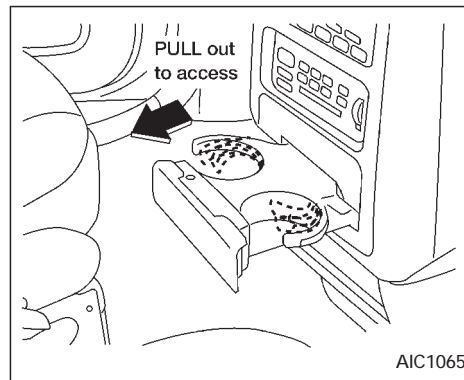

To use the cup holder, pull out. To store the cup holder, push it back in.

The cup holder can be adjusted to fit smaller cups by pushing the arms in. The arms have three detents and then return to the fully open position.

### WARNING

**The driver should not pull out the cup holder or remove or insert cups into the cup holder while driving in order that full attention may be given to the driving operation.**

**⚠ CAUTION**

- Avoid abrupt starting and braking when the cup holder is being used to prevent spilling the drink. If the liquid is hot, it can scald you or your passenger.
- Use only soft cups in the cup holder. Hard objects can injure you in an accident.

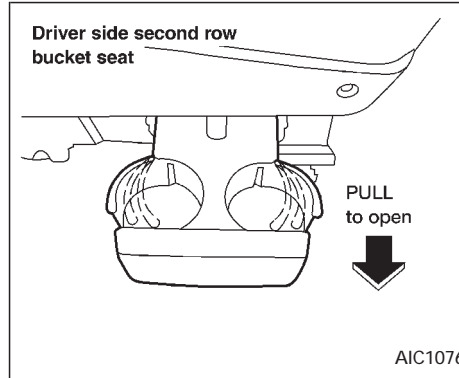

### Second row cup holder

Vehicles equipped with second row bucket seats have a cup holder attached to the side of the seat.

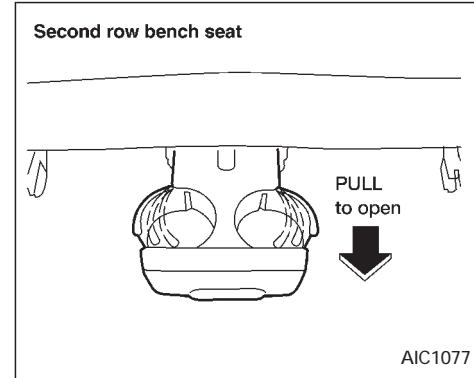

Vehicles equipped with a second row bench seat have a cup holder attached to the front center of the seat.

Pull the cup holder out from the seat to use it.

The cup holder can be adjusted to fit smaller cups by pushing in the arms. The arms have three detents and then return to the fully open position.



## MAP POCKETS

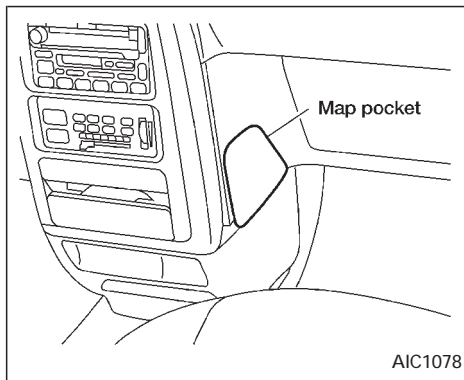

A map pocket is located on the right hand side of the instrument panel and on the back of the passenger seat. The map pockets can be used to store maps.

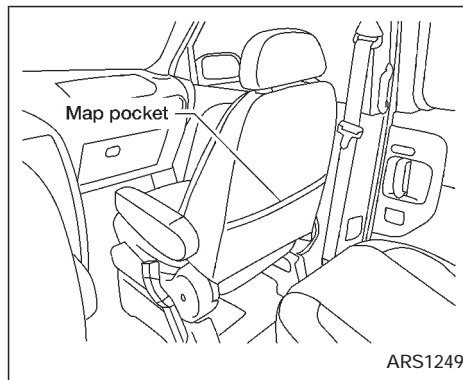

## OVERHEAD STORAGE COMPARTMENT

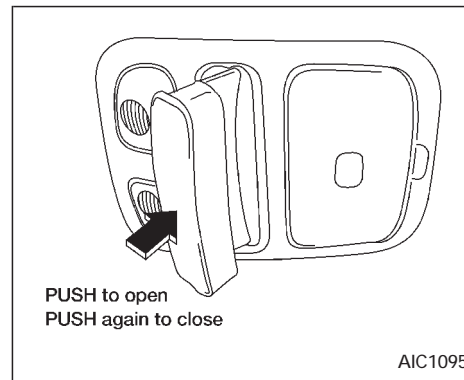

Some vehicles are equipped with an overhead storage compartment. Push to open the storage compartment. Push again to close the storage compartment.

## POWER WINDOWS

### WARNING

- Make sure that all passengers have their hands, etc. inside the vehicle before closing the windows. Use the window lock switch to prevent unexpected use of the power windows.
- Do not leave children unattended inside the vehicle. They could unknowingly activate switches or controls and become trapped in a window. Unattended children could become involved in serious accidents.

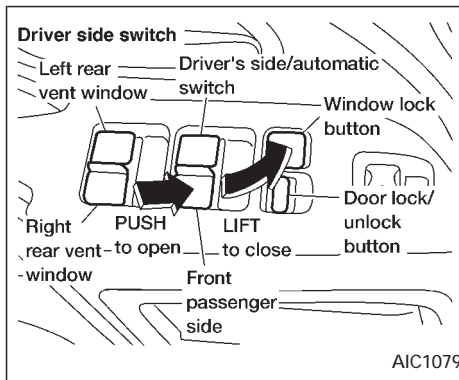

The main switch (on the driver side) opens or closes the driver's, and passenger's windows, and (if so equipped) rear vent windows.

To open the window, press the switch down. To close the window, lift the switch up.

The power windows operate when the ignition key is in the ON position, or for 15 minutes after the ignition key is turned to the OFF position. If the driver's or passenger's door is opened during this 15 minute period, power to the windows is cancelled.

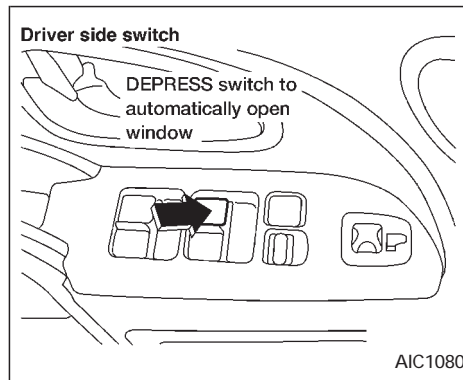

### AUTOMATIC POWER WINDOW SWITCH

To fully open the driver side window, press down firmly on the switch and release it; you do not need to hold the switch down. The window automatically opens all the way.

The automatic feature can be interrupted before the window is fully open by briefly lifting up on the switch as the window moves down.

## SUNROOF (if so equipped)

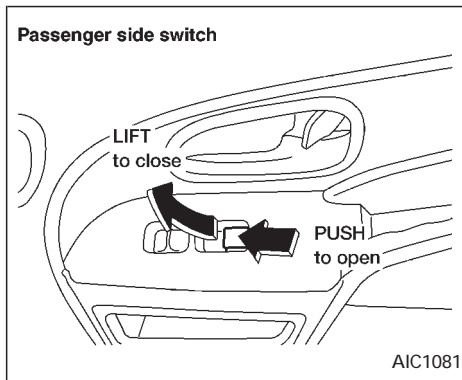

### Locking passenger's window

When the power window lock-out button is pushed in, the passenger's window cannot be opened or closed. Push the power window lock-out button again to cancel this feature.

The passenger side switch opens or closes the passenger window only. To open the window, press the switch down. To close the window, lift the switch up.

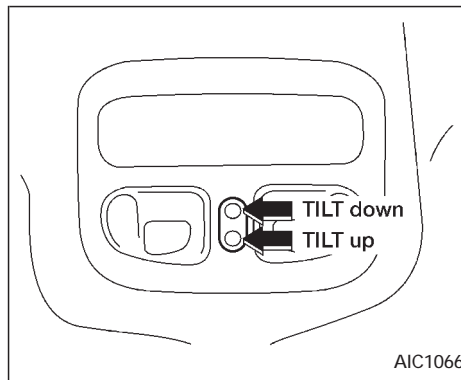

The sunroof operates when the ignition key is in the ON position, or for 15 minutes after the ignition key is turned to the OFF position. If the driver's or passenger's door is opened during this 15 minute period, power to the sunroof is cancelled.

#### NOTE:

If the battery is discharged or is disconnected, the sunroof may not operate correctly, and must be reset.

To reset a fully or partially open sunroof:

1. Push and hold the UP/CLOSE side of the sunroof switch until the sunroof closes,

and tilts up to the fully open position, then release the switch.

2. Push and hold the DOWN/OPEN side of the switch until the sunroof lowers completely. The sunroof is now reset and should operate correctly.

To reset a fully or partially tilted, or closed sunroof:

1. Push and hold the UP/CLOSE side of the sunroof switch until the sunroof stops tilting up, then release the switch.
2. Push and hold the DOWN/OPEN side of the switch until the sunroof lowers completely. The sunroof is now reset and should operate correctly.

### Sliding the sunroof

To open the roof, push and hold the OPEN side of the switch.

To close the roof, push and hold the CLOSE side.

### Tilting the sunroof

To tilt up, first close the sunroof, then push the UP side of the switch. To close the sunroof, push the DOWN side of the switch.

## MANUAL VENT WINDOWS

### Sun shade

Open and close the sun shade by sliding it forward or backward. The shade opens when the sunroof opens, but it must be closed manually.

#### WARNING

- In an accident you could be thrown from the vehicle through an open sunroof. Always use seat belts and child restraints.
- Do not allow anyone to stand up or extend any portion of their body out of the opening while the vehicle is in motion or while the sunroof is closing.

#### CAUTION

- Remove water drops, snow, ice or sand from the sunroof before opening.
- Do not place any heavy object on the sunroof or surrounding area.

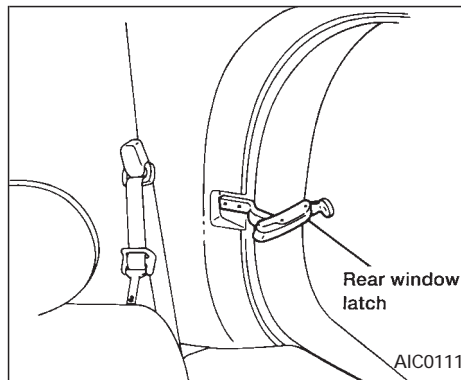

To open the manual vent windows, pull the rear portion of the latch toward you until it releases. To lock the window in the open position, push the latch rearward until you hear it latch. To close the windows, pull the latch toward you and push the rear portion of the latch toward the rear of the vehicle until you feel it latch.

## POWER VENT WINDOWS (if so equipped)

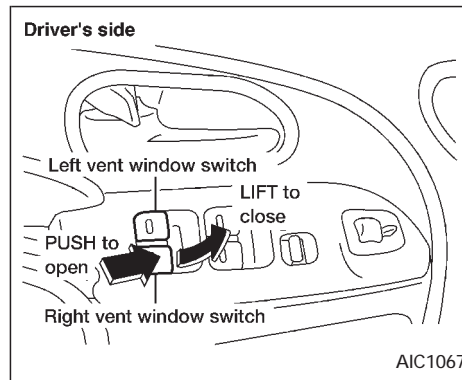

Use the vent window switches on the driver's side window controls to open and close the power vent windows. To open one of the power vent windows, press the switch down. To close the window, lift the switch up.

The power vent windows operate when the ignition key is in the ON position, or for 15 minutes after the ignition key is turned to the OFF position. If the driver's or passenger's door is opened during this 15 minute period, power to the vent windows is cancelled.

## INTERIOR LIGHTS

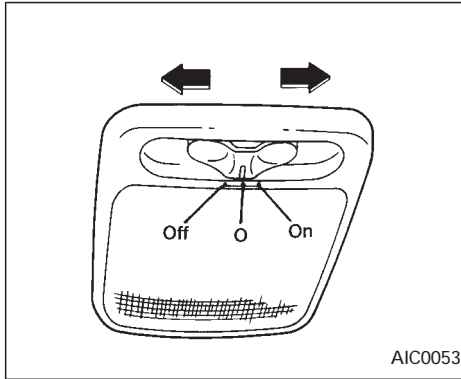

The interior lights operate regardless of ignition key position.

One interior light is located overhead near the front seats and one is overhead near the rear seat.

The interior lights have three-position switches:

- When the switch is in the OFF position, the interior light does not illuminate, regardless of door position.
- When the switch is in the center O position, the light illuminates when a door is opened.

### 2-24 Instruments and controls

- When the switch is in the ON position, the interior light illuminates, whether any door is open or closed.

#### CAUTION

**Leaving the interior light switch in the ON position for extended periods of time will result in a discharged battery.**

## LUGGAGE COMPARTMENT LIGHTS

When the back door is opened, the luggage compartment light and the rear interior light illuminate.

When the back door is closed, the lights go off.

## PERSONAL READING LIGHT

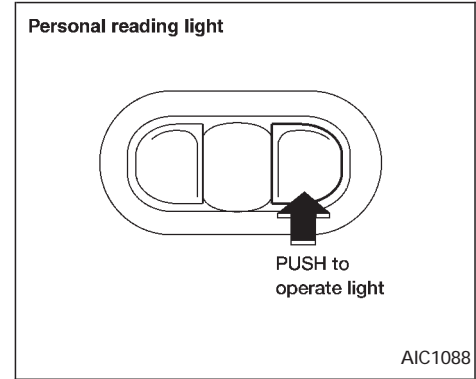

The driver's side, second and third row seating positions have a personal reading light located in the overhead trim panel.

To turn the light on, press once on the right-hand side of the light cover.

To turn the light off, press again on the right-hand side of the light cover.

## MAP LIGHTS

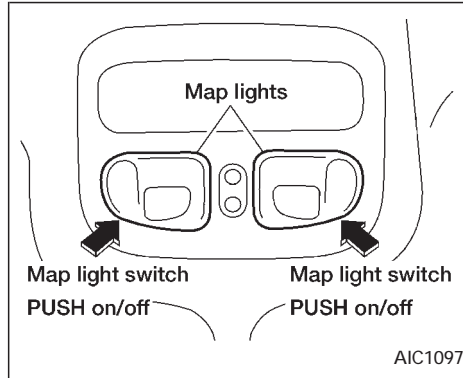

To turn on the map lights, press the switches. To turn them off, press the switches again.

## ILLUMINATED ENTRY SYSTEM

The interior lights, the cargo light, the glove box light, the stepwell lights near the sliding doors and on the front doors, and the footwell lights near the driver's and front passenger's feet illuminate when the front or sliding doors are opened. Once the doors are closed, these lights gradually dim to off within 30 seconds or turn off immediately when the key is turned to the ON position.

### Battery saver

If the vehicle doors are not fully closed and the interior lights remain illuminated, they eventually turn off automatically to prevent the battery from becoming discharged. If the interior lights are left in the ON position, with all doors closed, they will automatically turn off after approximately 30 minutes. Lights that illuminate when the front or sliding doors are opened turn off after approximately 30 minutes. Lights that illuminate when the back door is opened turn off after approximately 60 minutes. Vanity mirror lights are not part of the battery saver system.

If the personal reading lights are left on after the key is removed from the ignition, they will automatically turn off after approximately 30 minutes.

## STORAGE COMPARTMENT FOR GARAGE DOOR TRANSMITTER (if so equipped)

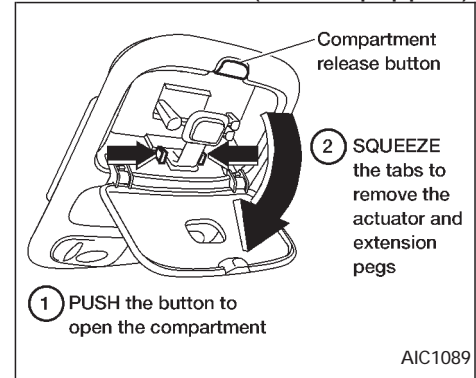

1 PUSH the button to open the compartment

2 SQUEEZE the tabs to remove the actuator and extension pegs

Some vehicles are equipped with an additional storage compartment in the map light unit. This storage compartment has been specially designed to hold some garage door transmitters. Some transmitters may not fit. When properly installed, the garage door transmitter can be activated while it is within the storage compartment.

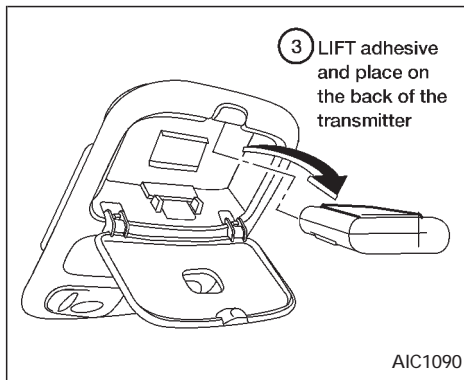

To install your transmitter, follow the numbered instructions in the illustrations.

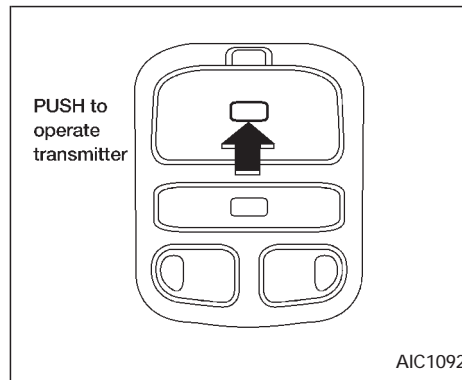
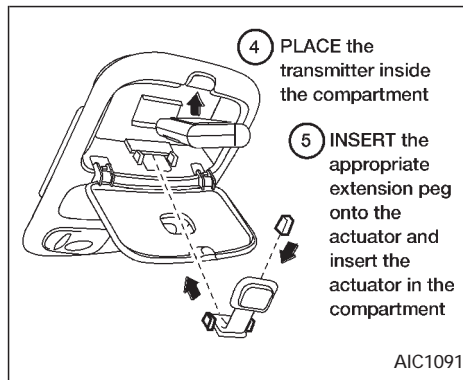

Once the garage door transmitter is installed, close the storage compartment door. Press the button on the center of the storage compartment door to operate the garage door transmitter.

## INTEGRATED HomeLink® UNIVERSAL TRANSCEIVER (if so equipped)

The Integrated HomeLink® Universal Transceiver provides a convenient way to consolidate the functions of up to three individual hand-held transmitters into one built-in device.

- The Integrated HomeLink® Universal Transceiver will operate garage doors, gates, home/office lighting systems and security systems by storing and transmitting the programming information of your current hand-held transmitters.
- The Integrated HomeLink® Universal Transceiver is built-in and powered by your vehicle's battery and charging system. No separate batteries are necessary.

### WARNING

**Do not use this Integrated HomeLink® Universal Transceiver with any garage door opener that lacks safety stop and reverse features as required by federal safety standards (these standards became effective for models manufactured after April 1, 1982). A garage door opener which cannot detect an object in the path of a closing garage door and then automatically stop and reverse the**

**door, does not meet current federal safety standards. Using a garage door opener without these features increases the risk of serious injury or death.**

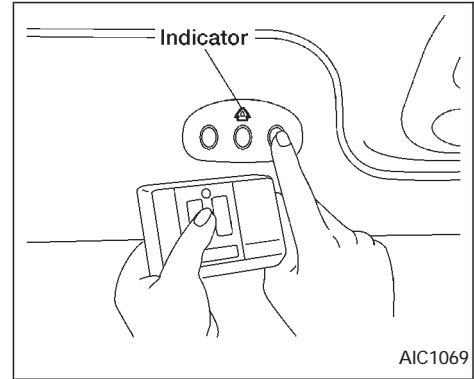

## PROGRAMMING THE HomeLink® UNIVERSAL TRANSCEIVER

### WARNING

**During the programming procedure your garage door or security gate will open and close (if the transmitter is within range). Make sure that people or objects are clear of the garage door, gate, etc. that you are programming.**



**Your vehicle's engine should be turned off while programming your transmitter. The Integrated HomeLink® Universal Transceiver may not work with older garage door openers that do not meet current Federal Consumer Safety Standards.**

1. Test the Integrated HomeLink® Universal Transceiver by pressing any button. The red indicator light should come on. If you have previously programmed a button proceed to step 3.
2. Clear all channels on the Integrated HomeLink® Universal Transceiver by holding down both outside buttons (#1 & #3) until the red light begins to flash rapidly (approximately 20 seconds). Then release both buttons.
3. Select which of the three Integrated HomeLink® Universal Transceiver buttons you want to program.
4. Hold your hand-held transmitter against the bottom surface of the Integrated HomeLink® Universal Transceiver so that you can still see the red indicator light.
5. Press the desired button until the red indicator light flashes slowly. Do not release the button. Continue holding and press the hand-held transmitter button through step 6.
6. Hold down both buttons until the red indicator light on the Integrated HomeLink® Universal Transceiver flashes rapidly (This may take 1 to 90 seconds). Then release both buttons. The rapid flashing means that the transceiver has been successfully programmed to match your hand-held transmitter. You can now use the Integrated HomeLink® Universal Transceiver instead of your hand-held transmitter.

#### **Note to Canadian users:**

Prior to 1992, D.O.C. regulations required many hand-held transmitters to stop transmitting after one or two seconds, even though you continue to hold down the button. If you think you have one of these hand-held transmitters, you should press and re-press the transmitter button every 2 seconds without ever releasing the Integrated HomeLink® Universal Transceiver button. The indicator light on the Integrated HomeLink® Universal Transceiver should

blink rapidly indicating a successful programming procedure. If it returns to the slow blink of program mode, continue to periodically reactivate your hand-held transmitter until a successful programming procedure is indicated by the rapidly flashing indicator light.

## **OPERATING THE TRANSCEIVER**

To operate, simply press the appropriate button on the Integrated HomeLink® Universal Transceiver. The red indicator light illuminates while the signal is being transmitted. The effective transmission range of the Integrated HomeLink® Universal Transceiver may differ from your hand-held transmitter.

## **PROGRAMMING PROBLEM DIAGNOSIS**

Be sure to keep your original hand-held transmitter for possible reprogramming if necessary.

- Make sure batteries in the hand-held transmitter are fully charged.
- Hold your hand-held transmitter against the bottom surface of the Integrated HomeLink® Universal Transceiver so

that you can still see the red indicator light.

- Hold buttons for duration of the programming without interruption.
- Rotate your hand-held transmitter end-over-end and program again. For best results, place the end opposite the battery compartment against the Integrated HomeLink® Universal Transceiver when programming.

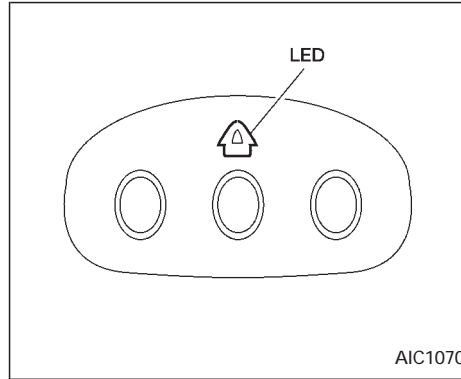

## ROLLING CODES

If your hand held transmitter appears to train to the Integrated HomeLink® Universal Transceiver, but does not open your garage door, and your garage door opener was manufactured after 1995, your garage door opener may have a Code Protected or Rolling Code feature. This type of system will change the code of your garage door opener every time you open or close your garage door.

To determine if you have one of these systems, depress the button on the Integrated HomeLink® Universal Transceiver

that you have just programmed. If the LED on the HomeLink® Universal Transceiver flashes rapidly for 1 to 2 seconds, then remains on, your garage door opener has a rolling code system.

To operate your rolling code garage door opener from your Integrated HomeLink® Universal Transceiver, follow these steps:

1. Program your hand held transmitter to the Integrated HomeLink® Universal Transceiver by following the procedures outlined previously (if not yet programmed).
2. Program your garage door opener receiver to recognize the Integrated HomeLink® Universal Transceiver (The Integrated HomeLink® Universal Transceiver follows the same procedure to train to the receiver as your hand held transmitter did when it was first installed):
  - a) Remove the cover panel from your garage door opener receiver. The receiver should be located by the garage door opener motor.
  - b) Locate the training button on the garage door opener receiver. The exact location and color of the button may

vary by garage door opener brand. If you have difficulty locating the training button, reference your garage door opener manual. If you have difficulty programming your garage door opener equipped with a rolling code system to recognize the Integrated HomeLink® Universal Transceiver with the Rolling Code feature, call NISSAN Consumer Affairs Department.

- c) Press the training button on the garage door opener receiver for 1 to 2 seconds.
- d) Return to the Integrated HomeLink® Universal Transceiver in the vehicle, and depress the programmed HomeLink® button for the duration of the fast blink on the Integrated HomeLink® Universal Transceiver (1 to 2 seconds). Release the button, and repress to confirm that the system has trained.
- e) Your garage door opener should now recognize your Integrated HomeLink® Universal Transceiver. You may use either your Integrated HomeLink® Universal Transceiver or your original

hand held transmitter to open your garage door.

## CLEARING THE PROGRAMMING INFORMATION

Should you sell your vehicle, be sure to clear the channels of the Integrated HomeLink® Universal Transceiver. To clear the channels, simultaneously hold down the outside two buttons (#1 & #3) until the red indicator light begins to flash rapidly (approximately 20 seconds). This will clear all three buttons. Individual buttons cannot be cleared, but can be reprogrammed at any time by following the programming procedures described previously.

## IF YOUR VEHICLE IS EVER STOLEN

If your vehicle has been stolen, you should change the codes of any device that was programmed into the Integrated HomeLink® Universal Transceiver as soon as possible. Consult the owners manual of each device, or call the manufacturer or dealer of those devices.

**When your vehicle is recovered, you will have to reprogram the Integrated**

**HomeLink® Universal Transceiver with your new transmitter information.**

### FFC Notice:

**This device complies with FCC rules part 15. Operation is subject to the following two conditions: (1) This device may not cause harmful interference and (2) This device must accept any interference that may be received, including interference that may cause undesired operation.**

**The transmitter has been tested and complies with FCC and DOC/MDC rules. Changes or modifications not expressly approved by the party responsible for compliance could void the user's authority to operate the device.**

**DOC: ISTD 1763K1313**

**FCC I.D.: CB2V67690**

# 3 Pre-driving checks and adjustments

Key .....	3-2	Parcel shelf (if so equipped) .....	3-17
Door locks .....	3-2	Luggage rack (if so equipped) .....	3-19
Manual door lock.....	3-3	Fuel filler lid and cap.....	3-20
Child safety sliding door lock.....	3-6	Tilting steering wheel .....	3-21
Power door lock (if so equipped).....	3-7	Memory driver seat and mirrors (if so equipped) .....	3-21
Multi-remote control system (if so equipped).....	3-9	Multi-remote controller system entry.....	3-21
Battery replacement .....	3-11	Memory driver seat and mirror buttons.....	3-22
Illuminated entry system .....	3-12	Outside mirror control.....	3-23
Hood release.....	3-12	Outside mirrors.....	3-24
Glove box .....	3-13	Inside mirror .....	3-24
Front seat convenience net .....	3-14	Vanity mirror .....	3-24
Rear door lock.....	3-15		
Cargo net (if so equipped) .....	3-16		

## KEY

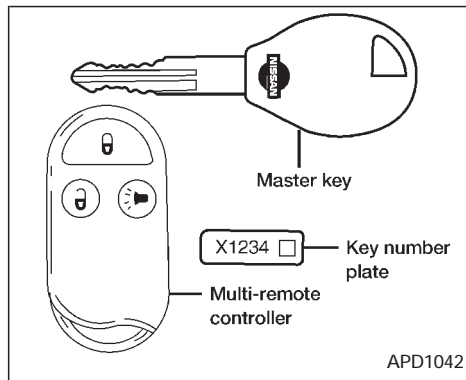

A key number plate is supplied with your key. Record the key number and keep it in a safe place (such as your wallet), **NOT IN THE CAR**. A key number plate is supplied with your key. Keep the plate in a safe place. NISSAN does not record key numbers so it is very important to keep track of your key number plate.

A key number is necessary only when you have lost all vehicle keys and do not have one to duplicate. If you still have a key, this key can be duplicated by an authorized NISSAN dealer or locksmith shop.

### 3-2 Pre-driving checks and adjustments

Two keys are supplied with your vehicle — one has a plastic head and one is all metal. Both keys perform the same functions.

## DOOR LOCKS

### WARNING

- Always have the doors locked while driving. Along with the use of seat belts, this provides greater safety in the event of an accident by helping to prevent persons from being thrown from the vehicle. This also helps keep children and others from unintentionally opening the doors, and will help keep out intruders.
- Before opening any door, always look for and avoid oncoming traffic.
- Do not leave children unattended inside the vehicle. They could unknowingly activate switches or controls. Unattended children could become involved in serious accidents.

### CAUTION

- Always use the door handle to open or close the sliding doors. Do not attempt to open or close the doors by merely placing your hand on the door edge or door slide roller, as this may cause injury.

- Always be sure that hands and feet are clear of the door frame to avoid injury while closing a sliding door.
- When opening a sliding door on a slope, ensure that it is fully open and that it does not close by itself.

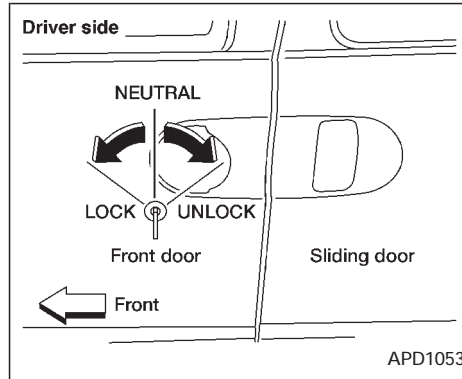

### MANUAL DOOR LOCK

To lock a front door from the outside, turn the key toward the front of the vehicle. To unlock, turn it toward the rear.

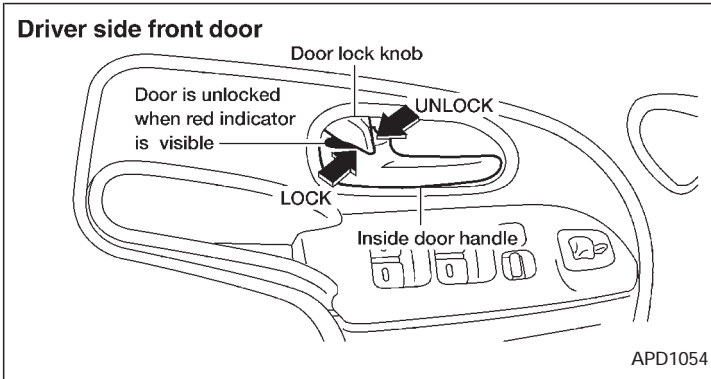

### Locking the doors without the key

To lock a front door from inside the vehicle, push the door lock knob in, then close the door.

When locking the door this way, be certain not to leave the key inside the vehicle.

### 3-4 Pre-driving checks and adjustments

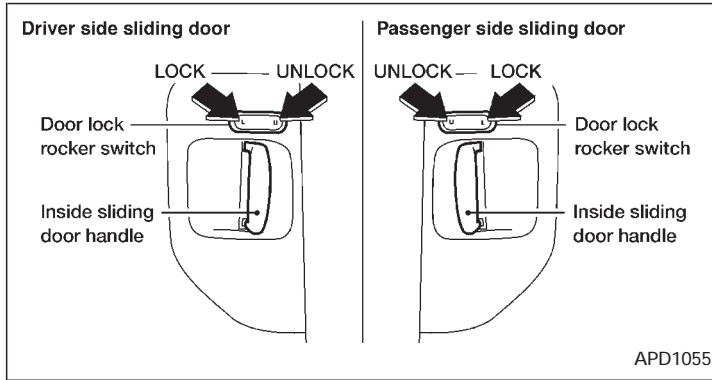

## Sliding door lock

To lock a sliding door from inside the vehicle, press the door lock rocker switch on the side marked L. To unlock, press the rocker switch on the side marked U.

**The driver side sliding door cannot be fully opened when the fuel door is open.**



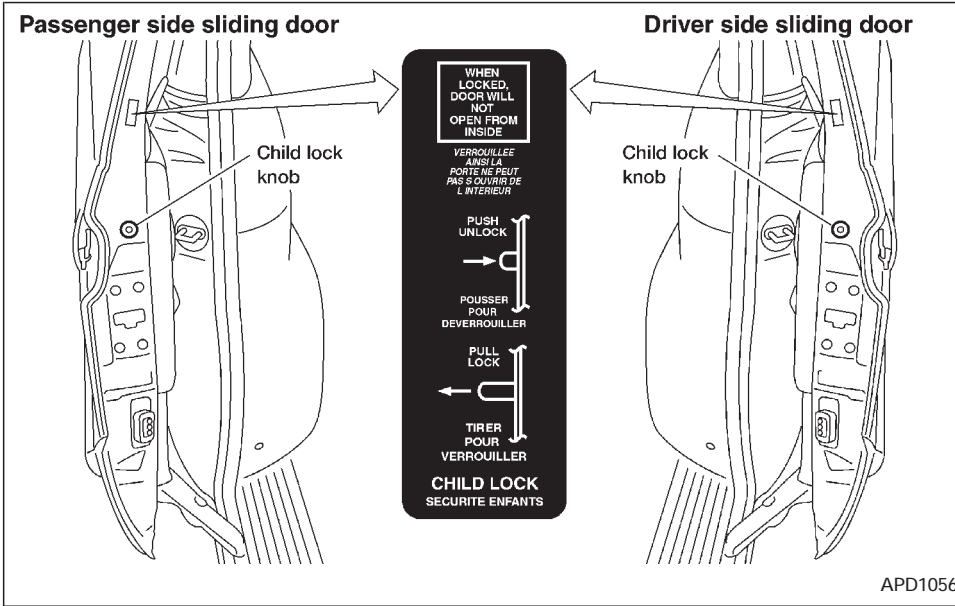

## CHILD SAFETY SLIDING DOOR LOCK

Child safety locking helps prevent doors from being opened accidentally, especially when small children are in the vehicle.

**When the lever is in the LOCK position, the sliding doors can be opened only from the outside.**

### 3-6 Pre-driving checks and adjustments

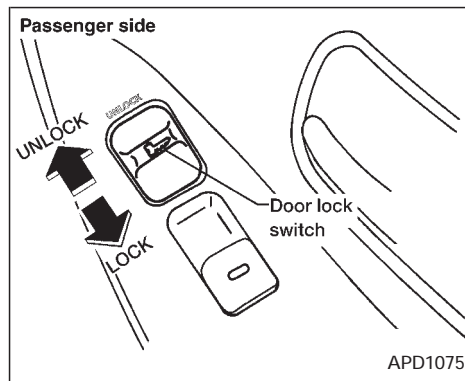
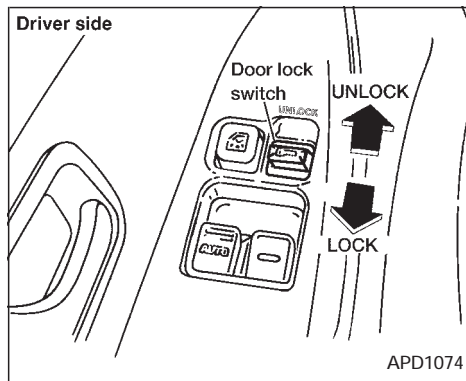

## POWER DOOR LOCK (if so equipped)

Operating the lock-unlock switch locks or unlocks all doors.

If the power door lock switch is pressed when a sliding door is open, the sliding door automatically locks when it is closed.

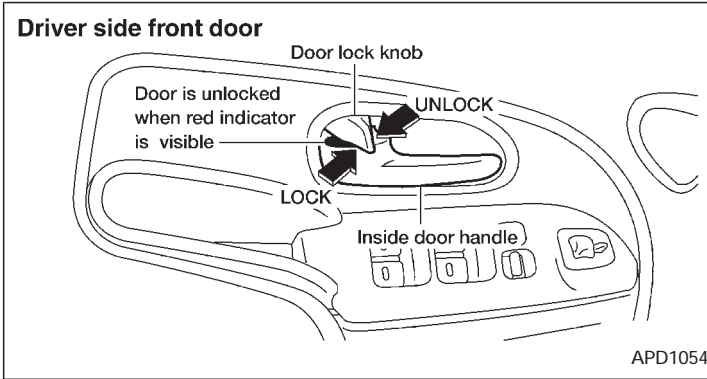

To lock all doors from inside the vehicle, push the door lock knob in, then close the door. When locking the doors this way, be certain not to leave the key inside the vehicle. All doors automatically unlock if the key is in the ignition and a door is open.

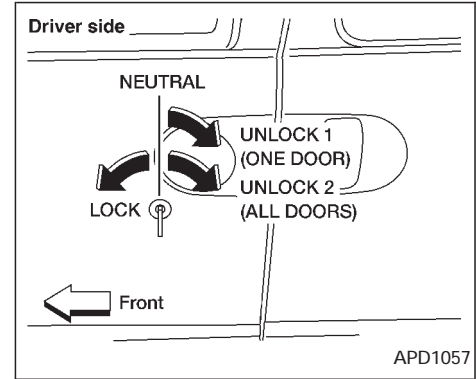

### Selective unlock

Turning the door key one time to the rear of the vehicle unlocks the corresponding door. From that position, returning the key to Neutral (where the key can only be removed and inserted) and turning it to the rear again within 5 seconds unlocks all doors. Turning the door key to the front of the vehicle locks all doors. The selective unlock function and locking all doors can be operated from the driver, passenger and rear door.

## MULTI-REMOTE CONTROL SYSTEM (if so equipped)

It is possible to lock/unlock all doors, turn the interior lights on or off, and activate the panic alarm by using the remote controller from outside the vehicle.

**Be sure to remove the key from the vehicle before locking the doors and leaving it.**

The remote controller can operate at a distance of approximately 30 ft (10 m) from the vehicle. The effective distance depends on the conditions around the vehicle.

As many as four remote controllers can be used with one vehicle. For more information concerning the purchase and use of additional remote controllers, contact an authorized NISSAN dealer.

### CAUTION

**Listed below are conditions or occurrences which will damage the remote controller:**

- **Do not allow the remote controller to become wet.**
- **Do not drop the remote controller.**
- **Do not strike the remote controller sharply against another object.**



- **Do not place the remote controller for an extended period in an area where temperatures exceed 140°F (60°C).**

### Locking doors

1. Close all doors.
2. Push the  button on the multi-remote controller.
3. All doors lock.
4. The parking lights flash twice and the horn chirps once to verify all doors are locked.

### Unlocking doors

**For memory seat and mirror information** see “Memory driver seat and mirrors” later in this section.





1. Push the  button on the multi-remote controller. Only the driver door unlocks. Parking lights flash once.
2. The interior lights come on and stay on for 30 seconds.
3. Push the  button on the multi-remote controller again within five seconds. The

passenger door, sliding doors, and the rear door unlock.

The interior lights can be turned off without waiting 30 seconds by either turning the ignition to ON or locking the doors with the multi-remote controller.

### Using the panic alarm

If you are near your vehicle and feel threatened, you may activate the panic alarm to call attention as follows:

1. Push and hold the  button on the remote controller for at least one full second.
2. The theft warning alarm (horn) sounds and the headlights and tail lights flash for 30 seconds.
3. The panic alarm stops when:
  - it has run for 30 seconds, or
  - the  or the  button is pressed, or
  - the  button is released and re-pushed.

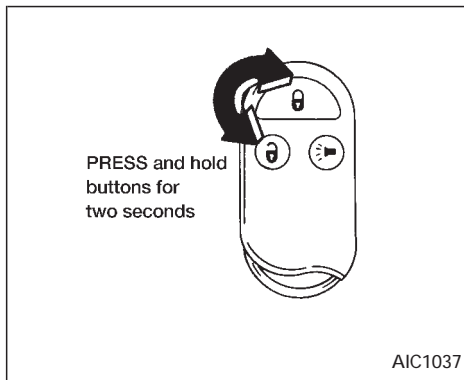



The hazard lights will quickly flash three times to confirm that the horn beep feature has been reactivated.



Deactivating the horn feature does not silence the horn if the alarm is triggered.

## Silencing the horn beep feature

If desired, the horn beep feature can be deactivated using the multi-remote controller. The instructions are on the back of the multi-remote controller.

**To deactivate:** Press and hold the  and  buttons **for at least two seconds**.

The hazard lights will quickly flash three times to confirm that the horn beep feature has been deactivated.

**To activate:** Press and hold the  and  buttons **for at least two seconds once more**.

## 3-10 Pre-driving checks and adjustments

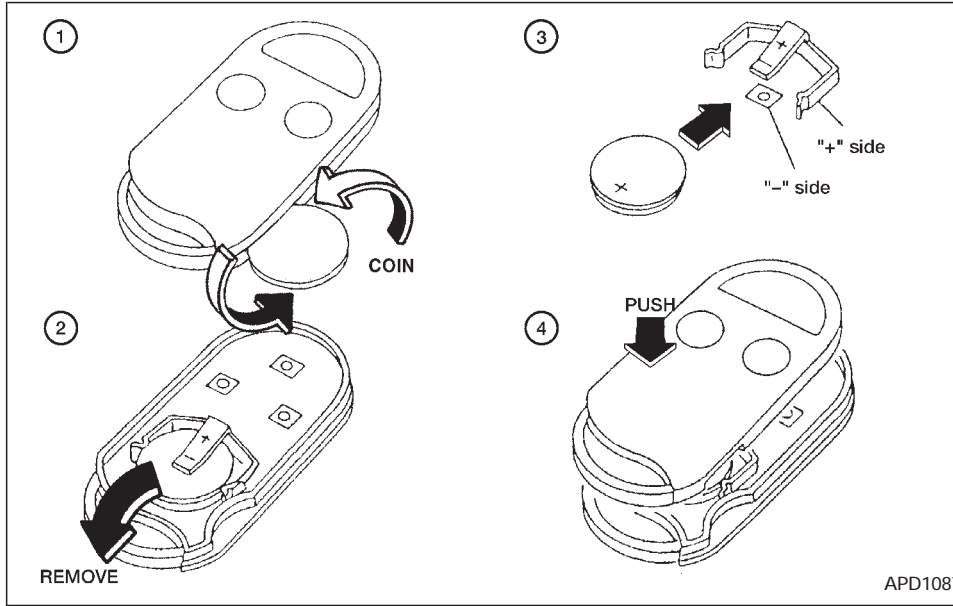

# BATTERY REPLACEMENT



Replace the battery as follows:

1. Open the lid using a coin.
2. Replace the battery with a new one. Insert the batteries as illustrated above.  
Recommended battery: Panasonic CR2025, 3V or equivalent.

3. Close the lid securely.

4. Press the  button, then the  button two or three times to check the multi-remote controller operation.

If the batteries are removed for any reason other than replacement, perform step 4.

- An improperly disposed battery can hurt the environment. Always conform to local regulations for battery disposal.
- The multi-remote controller is water-resistant; however, if it does get wet, immediately wipe completely dry.
- The operational range of the multi-remote controller extends to approximately 30 ft (10 m) from the vehicle. This range may vary with conditions.

## FCC Notice:

Changes or modifications not expressly approved by the manufacturer for compliance could void the user's authority to operate the equipment.

This device complies with part 15 of the FCC Rules and RSS-210 of Industry Canada.

Operation is subject to the following two conditions: (1) This device may not cause harmful interference, and (2) this device must accept any interference received, including interference that may cause undesired operation of the device.

## ILLUMINATED ENTRY SYSTEM

The interior lights, the cargo light, the glove box light, the stepwell lights near the sliding doors and on the front doors, and the footwell lights near the driver's and front passenger's feet illuminate when the front or sliding doors are opened. Once the doors are closed, these lights gradually dim to off within 30 seconds or turn off immediately when the key is turned to the ON position.

### Battery saver

If the vehicle doors are not fully closed and the interior lights remain illuminated, they eventually turn off automatically to prevent the battery from becoming discharged. If the interior lights are left in the ON position, with all doors closed, they will automatically turn off after approximately 30 minutes. Lights that illuminate when the front or sliding doors are opened turn off after approximately 30 minutes. Lights that illuminate when the back door is opened turn off after approximately 60 minutes. Vanity mirror lights are not part of the battery saver system.

If the personal reading lights are left on after the key is removed from the ignition, they will automatically turn off after approximately 30 minutes.

## 3-12 Pre-driving checks and adjustments

## HOOD RELEASE

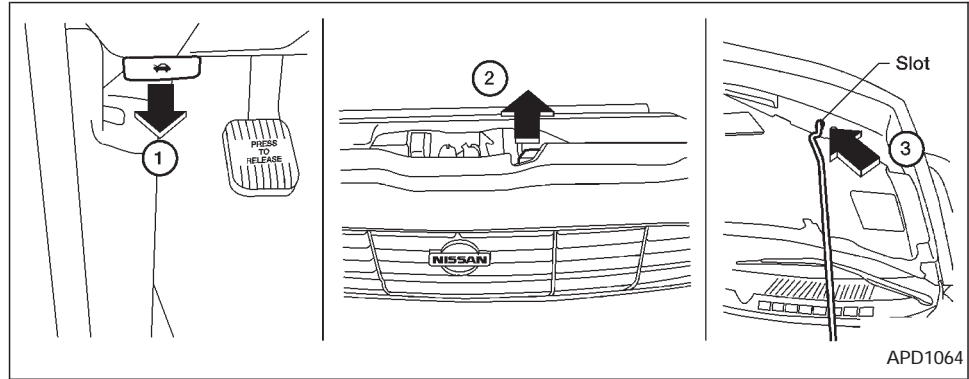

1. Pull the hood lock release handle ① located below the instrument panel; the hood then springs up slightly.
2. Pull up on the lever ② at the front of the hood and raise the hood.
3. Insert the support rod ③ into the slot on the underside of the hood.
4. When closing the hood, reset the support rod to its original position, lower the hood to approximately 12 inches above the latch and release it. This allows proper engagement of the hood latch.

## GLOVE BOX

### WARNING

- Make sure the hood is completely closed and latched before driving. Failure to do so could cause the hood to fly open and result in an accident.
- If you see steam or smoke coming from the engine compartment, to avoid injury do not open the hood.

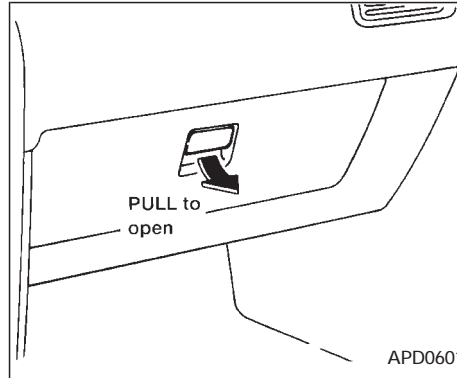

Open the glove box by pulling the handle.

### CAUTION

Keep glove box lid closed while driving to prevent injury in an accident or a sudden stop.



## FRONT SEAT CONVENIENCE NET

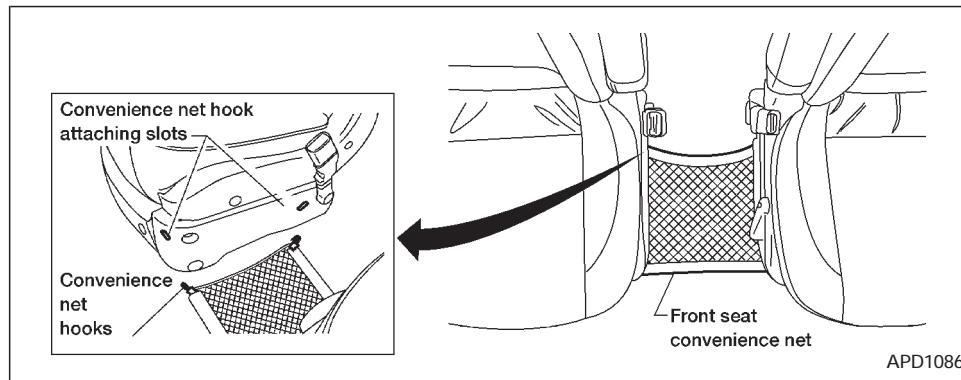

The front seat convenience net keeps small packages in the front passenger compartment from moving around while the vehicle is in motion.

To install the convenience net, attach the four hooks to the four slots in the base of the front seats.

To remove the convenience net, detach the four hooks from four slots in the base of the front seats.

When not in use, the convenience net can be stored in the passenger side underseat storage tray (if so equipped). See “Under-seat storage tray” in the “Seats, restraints and supplemental air bag systems” section.

## REAR DOOR LOCK

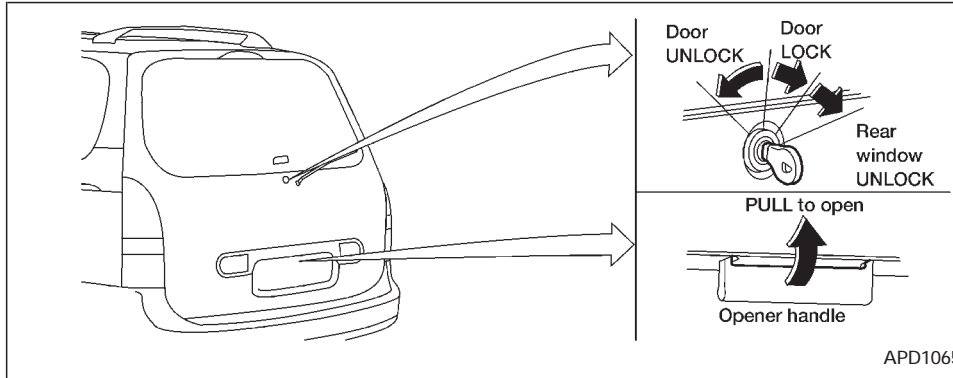

### Key operation

To unlock the rear door, turn the key counterclockwise. To open the rear door, lift up on the opener handle near the license plate. To close, lower and push the rear door down securely.

#### WARNING

**Do not drive with the rear door or glass open. This could allow dangerous exhaust gases to be drawn into the vehicle. See “Exhaust gas” in the “Starting and driving” section of this manual.**

To lock the rear door with the key, turn the key clockwise as shown in the illustration.

Turning the key fully clockwise unlocks the rear window on models equipped with the flip-up rear window. The rear wiper automatically lowers when the key is turned fully clockwise. Do not force the wiper to lower by hand.

To close the rear window, firmly push on the window until it locks in place. The rear wiper automatically returns to the original position.

## CARGO NET (if so equipped)

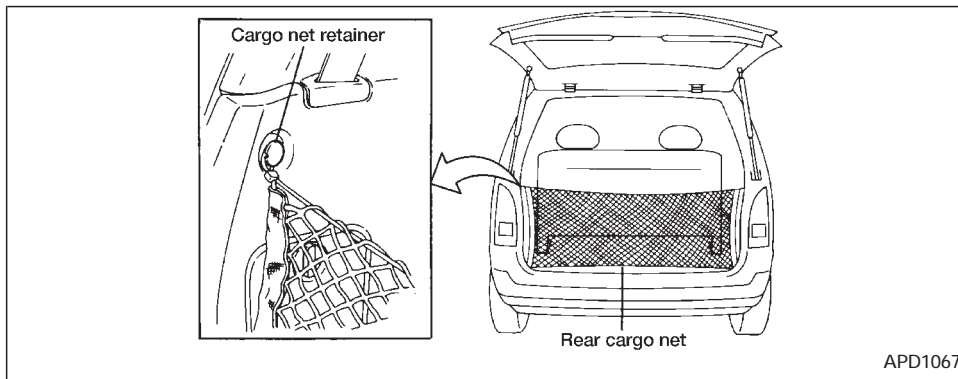

The cargo net keeps packages in the cargo area from moving around while the vehicle is in motion.

To install the cargo net, attach the four loops to the four retainers.

To remove the cargo net, detach the four loops from the cargo net retainers.

### **WARNING**

- **Properly secure all cargo to help prevent it from sliding or shifting. Do not place cargo higher than the seat-backs. In a sudden stop or collision, unsecured cargo could cause personal injury.**
- **Be sure to secure all four loops onto the retainers. The cargo restrained by the net must not exceed 50 lbs. (22.7 kg) or the net may not stay secured.**

## PARCEL SHELF (if so equipped)

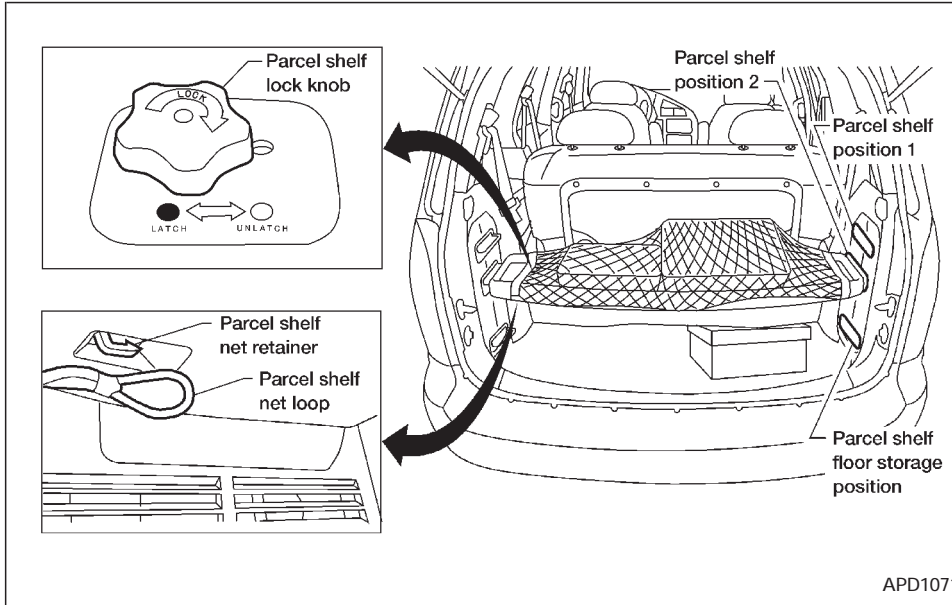

### **⚠ WARNING**

- Before using the parcel shelf, the three-passenger bench seat must be in the third row position, and the

seat back must be upright.

- After adjusting the parcel shelf to the desired height, make sure the lock knob is securely latched.

- Properly secure all packages under the parcel shelf net to prevent them from sliding or shifting. Do not place packages higher than the three-passenger bench seat back. In a sudden stop or collision, unsecured packages could cause personal injury.
- Be sure to secure all three parcel shelf net loops onto the retainers located on the bottom side of the parcel shelf. The packages placed on the parcel shelf and restrained by the parcel shelf net must not exceed 30 pounds (13.6 kg), or the parcel shelf may not remain secure.
- Do not allow people or pets on or under the parcel shelf.
- The parcel shelf must be removed from the vehicle if installing a child restraint on the three-passenger bench seat that requires the use of a top tether strap that is anchored to the vehicle floor. Failure to remove the parcel shelf can increase the severity of injury to the child in an accident.

The parcel shelf allows for additional storage for packages.

Do not load more than 30 pounds (13.6 kg) on the parcel shelf. The parcel shelf can be installed at two different heights and in a storage position.

To install the parcel shelf:

- Position the right side of the parcel shelf in to one of the shelf positions on the right side luggage compartment trim panel.
- Position the left side of the parcel shelf into the matching position (same height) on the left side luggage compartment trim panel.
- Slide the parcel shelf lock knob fully to the left side (latch in green dot position).
- Turn the parcel shelf lock knob clockwise until securely locked.

The parcel shelf is also equipped with a parcel shelf net to keep packages on the parcel shelf from moving around while the vehicle is in motion.

The parcel shelf net is permanently attached to the back side of the parcel shelf.

Pull the parcel shelf net over the packages

and attach the three loops to the three retainers on the bottom side of the parcel shelf. Make sure the parcel shelf is securely locked before covering the packages with the parcel shelf net.

To remove the parcel shelf:

- Unlock the parcel shelf net.
- Remove all packages from the parcel shelf.
- Turn the parcel shelf lock knob counter clockwise until loose (maximum two turns).
- Slide the parcel shelf lock knob fully to the right side (unlatch in red dot position).
- Remove the parcel shelf from the left side luggage compartment trim panel, then the right side luggage compartment trim panel and reposition the parcel shelf where desired.

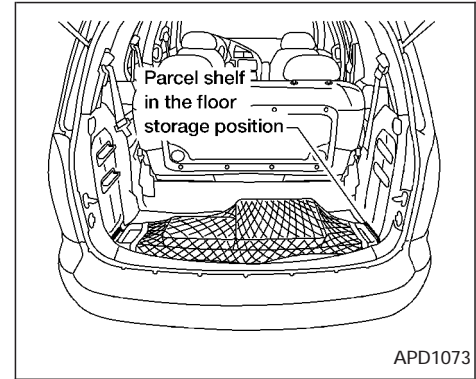

Put the parcel shelf in the floor storage position when the parcel shelf is not used or required.

## LUGGAGE RACK (if so equipped)

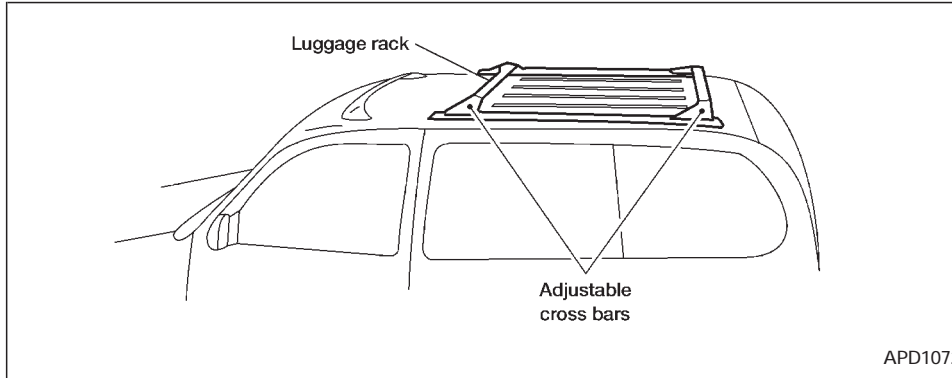

Always distribute the luggage evenly on the luggage rack. Do not load more than 100 pounds (45 kg). Be careful that your vehicle does not exceed the Gross Vehicle Weight Rating (GVWR) or its Gross Axle Weight Rating (GAWR front and rear). The GVWR and GAWR are located on the Safety Compliance Certification Label (located on the driver's door pillar). For more information regarding GVWR and GAWR, refer to "Technical and Consumer Information".

The front and rear cross-bars can be adjusted forward and backward. Place your luggage between the bars, adjust the bars,

and secure the luggage with rope to the bars. Always check the tightness of the adjusting knobs. There are also adjustable loops on the side bars for the rope attachment.

### CAUTION

**Use care when placing or removing items from the luggage rack. If you cannot comfortably lift the items onto the luggage rack from the ground, use a ladder or stool.**

## FUEL FILLER LID AND CAP

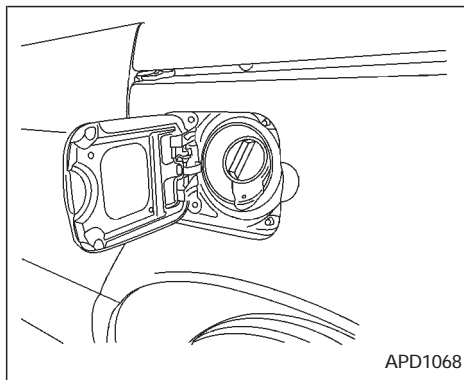

To open the fuel filler lid, grasp the right hand edge of the lid and pull.

The fuel filler cap is a screw-on ratcheting type. Tighten the cap clockwise until ratcheting clicks are heard. Ensure the plastic tether doesn't get caught between the fuel filler cap and the fuel filler neck.

**The driver side sliding door cannot be fully opened when the fuel door is open. Make sure the driver side sliding door is completely closed before opening the fuel door.**

### WARNING

- Gasoline is extremely flammable and highly explosive under certain conditions. You could be burned or seriously injured if it is misused or mishandled. Always stop the engine and do not smoke or allow open flames or sparks near the vehicle when refueling.
- Fuel may be under pressure. Turn the cap one-half turn, and wait for any “hissing” sound to stop to prevent fuel from spraying out and possible personal injury. Then remove the cap.
- Do not attempt to top off the fuel tank after the fuel pump nozzle shuts off automatically. Continued refueling may cause fuel overflow, resulting in fuel spray and possibly a fire.
- Use only a genuine NISSAN fuel filler cap as a replacement. It has a built-in safety valve needed for proper operation of the fuel system and emission control system. An incorrect cap can result in a serious malfunction and possible injury.

- Never pour fuel into the throttle body to attempt to start your vehicle.

### CAUTION

- If fuel is spilled on the vehicle body, flush it away with water to avoid paint damage.
- Tighten until the cap clicks. Failure to tighten the fuel cap properly may cause the  malfunction indicator light (MIL) to illuminate. If this occurs, securely close the fuel filler cap. After driving for a while, the light should remain off. If the light remains on, have the vehicle inspected by an authorized NISSAN dealer.

For additional information, see the “Malfunction indicator light (MIL)” in the “Instruments and controls” section.

## TILTING STEERING WHEEL

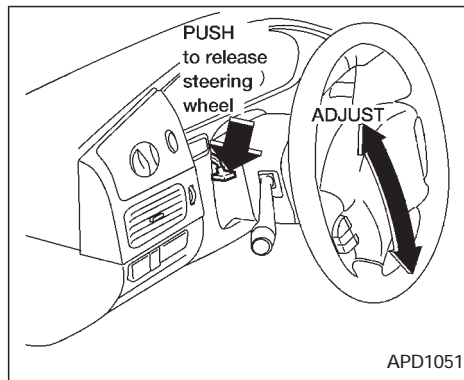

Push the lock lever down and adjust the steering wheel up or down to the desired position. Pull the lock lever up firmly to lock the steering wheel in place.

Gently pull down on the wheel to make sure it is properly locked.

### WARNING

**Do not adjust the steering wheel while driving. You could lose control of your vehicle and cause an accident.**

## MEMORY DRIVER SEAT AND MIRRORS (if so equipped)

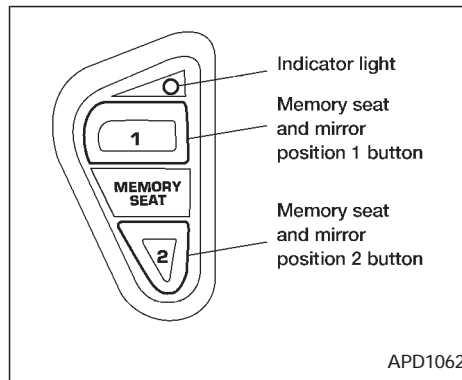

The memory driver seat and mirror function provides a convenient way to recall a driver's seat and outside mirror positions. Unlocking the doors using the multi-remote controller, or by pressing the memory seat position 1 or position 2 button activates the memory driver seat and mirrors.

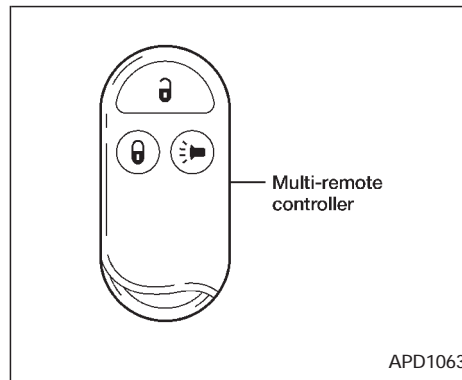

## Multi-remote controller system entry

Pressing the  button on the multi-remote controller unlocks the driver's door, and recalls the memory settings for both outside mirrors and driver's seat for that memory position. Two multi-remote controllers are delivered with the vehicle. They can be programmed with the same memory driver's seat and mirror positions, or each one can be programmed separately. One multi-remote controller can be programmed for memory driver's seat and mirror position 1, and the other for memory driver's seat and mirror position 2.



## Memory Driver Seat and Mirror Buttons

The memory seat and mirror buttons are located on the driver door. Pressing the memory driver seat and mirror position 1 or position 2 button will recall the memory settings for both outside mirrors and driver seat for that memory seat position, provided the vehicle is in P (Park) or N (Neutral). For easy vehicle exit, press memory driver seat and mirror position 1 and position 2 buttons together to move the driver seat fully rearward and fully downward. This function is preset and cannot be changed.

### Programming Memory Positions

1. Move the driver seat and outside mirrors to the desired position using the manual controls.
  2. Push and hold the memory seat and mirror position 1 or position 2 button for at least 3 seconds.
- The indicator light will illuminate and remain illuminated until the position is programmed.

- After the position has been programmed the indicator light will flash to indicate the position is set.

The driver seat and/or outside mirrors must be adjusted before programming position 1 or position 2.

### Programming a multi-remote controller

1. Move the driver seat and outside mirrors by pressing the desired position 1 or position 2 button.
2. Press and hold the same (position 1 or position 2) button.
3. Within 10 seconds press the  button on the multi-remote controller.

The controller is now programmed for that (position 1 or position 2) button.

After the multi-remote controller has been programmed, the memory seat and mirror button indicator light will flash to indicate the controller is programmed. If the memory seat button is pressed and held the indicator light will remain illuminated for as long as the button is held or 10 seconds which ever is shorter.

To remove a multi-remote controller from the memory seat system press and hold both memory seat and mirror position buttons 1 and 2 and then press the  button on the multi-remote controller.

# OUTSIDE MIRROR CONTROL

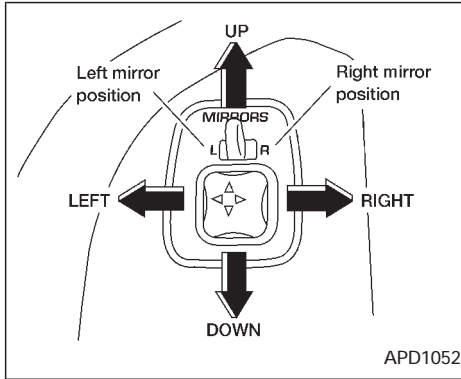

## Electric control type

The outside mirrors operate only when the ignition switch is in the ACC or ON position.

Move the switch to select the right or left side mirror, then adjust using the control lever.

### WARNING

Objects viewed in the outside mirror on the passenger side are closer than they appear. Be careful when moving to the right. Using only this mirror could

**cause an accident. Use the inside mirror or glance over your shoulder to properly judge distances to other objects.**

The electric control type outside mirrors can be heated to defrost, defog, or de-ice for improved visibility. Press the rear window defogger switch to activate the heating function. Press the switch again to deactivate, or the heating function will automatically turn off after approximately 15 minutes.

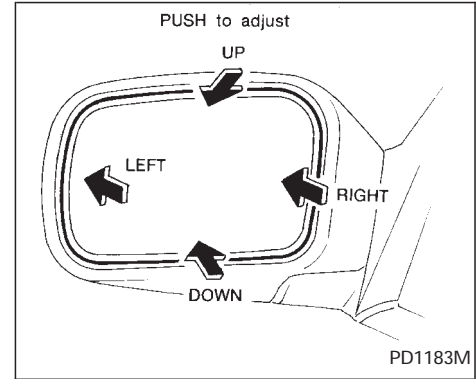

## Manual control type

The outside mirror can be moved in any direction for a better rear view.

### WARNING

Objects viewed in the outside mirror on the passenger side are closer than they appear. Be careful when moving to the right. Using only this mirror could cause an accident. Use the inside mirror or glance over your shoulder to properly judge distances to other objects.

## OUTSIDE MIRRORS

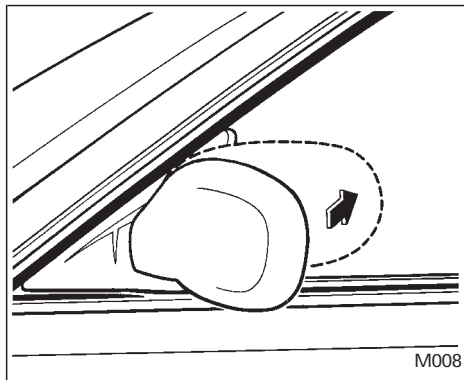

Push the outside mirrors backward to fold them.

## INSIDE MIRROR

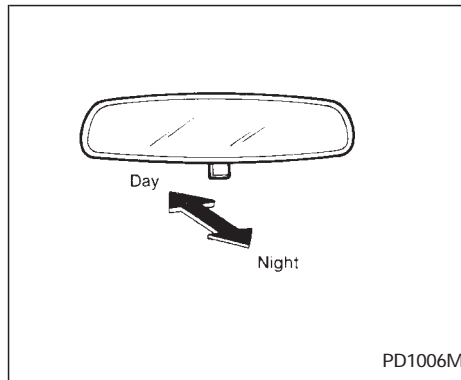

The night position reduces glare from the headlights of vehicles behind you at night.

### **WARNING**

**Use the night position only when necessary, because it reduces rear view clarity.**

## VANITY MIRROR

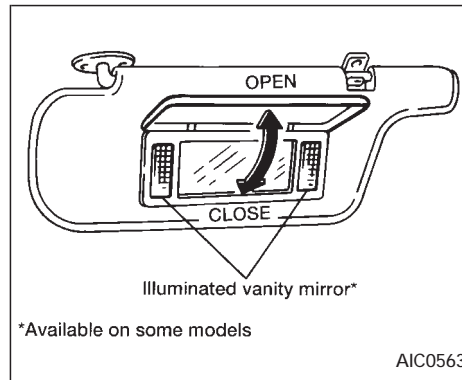

\*Available on some models

Your vehicle may be equipped with a driver or passenger side vanity mirror. If the vanity mirror on your vehicle has a cover, access the mirror by pulling the sun visor down and lifting the cover up. Some vanity mirrors illuminate when the mirror cover is opened.

# 4 Heater, air conditioner and audio systems

Ventilators .....	4-2
Heater and air conditioner (manual) .....	4-3
Controls .....	4-3
Heater operation .....	4-4
Air conditioner operation .....	4-5
Air flow charts.....	4-7
Heater and air conditioner (automatic) (if so equipped) .....	4-11
Automatic operation .....	4-12
Air control buttons .....	4-12
English/metric mode.....	4-13
Rear seat air conditioner (if so equipped) .....	4-14
Controls .....	4-14
Audio system.....	4-16
AM-FM radio with cassette player .....	4-16
Radio operation .....	4-16

Tuning .....	4-17
Adjusting tone quality and speaker balance.....	4-19
Cassette tape operation.....	4-20
AM-FM radio with cassette player and compact disc player .....	4-22
Radio operation .....	4-22
Tuning .....	4-23
Adjusting tone quality and speaker balance.....	4-25
Cassette tape operation.....	4-26
Compact disc (CD) player operation.....	4-28
Antenna .....	4-29
Compact disc (CD) player (if so equipped) .....	4-30
Steering wheel controls.....	4-32
Rear audio controls.....	4-33
CB radio or car phone.....	4-34



## VENTILATORS

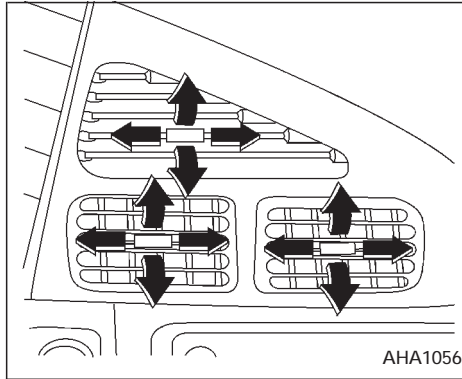

### Center ventilators

Open, close and adjust the air flow direction of ventilators.

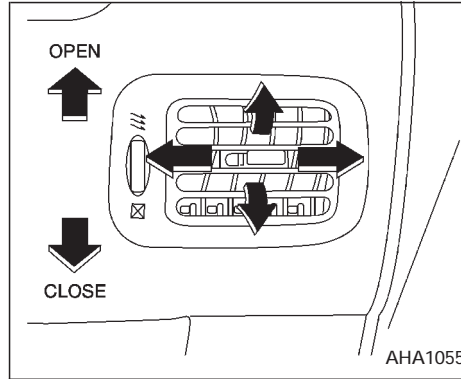

### Side ventilators

Open, close and adjust the air flow direction of ventilators.

☒ : This symbol indicates a vent is closed when the vent switch is moved down.

≡ : This symbol indicates a vent is open when the vent switch is moved up.

# HEATER AND AIR CONDITIONER (manual)

## ⚠ WARNING

- The air conditioner cooling function operates only when the engine is running.
- Do not leave children, unreliable adults, or pets alone in your vehicle. On hot, sunny days, temperatures in a closed vehicle could quickly become high enough to cause severe or possibly fatal injuries to people or animals.
- Do not use the MAX (recirculation) mode for long periods as it may cause the interior air to become stale and the windows to fog up.
- Positioning of the heater and air conditioner controls should not be done while driving, in order that full attention may be given to the driving operation.

The cabin air filter (if so equipped) requires periodic maintenance. See the “Do it yourself” section for additional information.

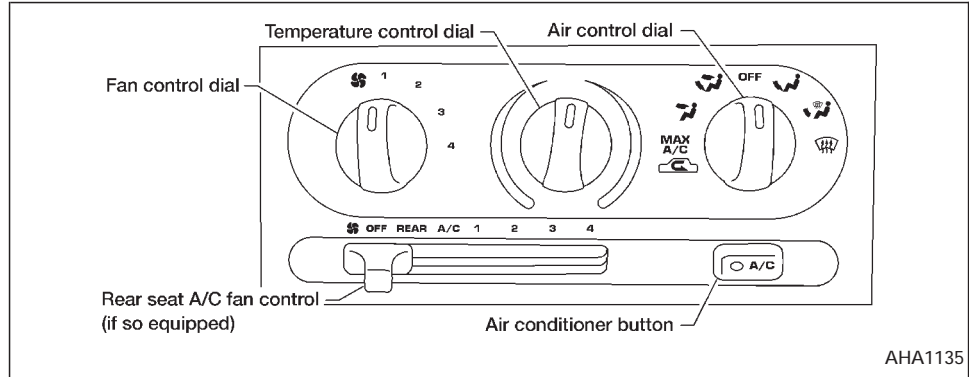

## CONTROLS

### Fan control dial

This dial controls fan speed.

### Temperature control dial

This dial allows you to adjust the temperature of the outlet air.

### Air control dial

This dial allows you to select the air flow outlets.

- Air flows mainly from center and side ventilators.
- Air flows from center and side ventilators and the front and rear foot outlets.
- Air flows mainly from the front and rear foot outlets.
- Air flows from defroster outlets and the front and rear foot outlets.
- Air flows mainly from defroster outlets.
- Air flows mainly from center and side ventilators.

## OFF position

The OFF position shuts off the air supply to all outlets and stops all fan operations. Use the OFF position to prevent cold air from entering the passenger compartment under cold outside conditions before the engine is warmed up.

## MAX A/C Position

Interior air is recirculated inside the vehicle.

**Turn the air control dial to the MAX A/C position when driving on a dusty road or to help keep out traffic fumes.**

Turn the air control dial to the MAX A/C position for improved air conditioner performance under high temperature and high humidity conditions.

### CAUTION

**Do not use MAX A/C for long periods as it may cause the interior air to become stale and the windows to fog up.**

## Air conditioner button

Start the engine, move the fan control dial to the desired (one to four) position, select an air control position and push the air condi-

tioner button to turn on the air conditioner. The indicator light comes on when the air conditioner is operating. To stop the air conditioner, push the button again; the indicator light goes off.

**The air conditioner cooling function operates only when the engine is running.**

## HEATER OPERATION

### Heating

This mode is used to direct most of the hot air to the front and rear floor outlets. Rear passenger heat is provided by the front system through floor outlets located under both front seats.

1. Move the air control dial to the  position.
2. Turn the fan control dial to select speed.
3. Move the temperature control dial to the desired position.

### Ventilation

This mode directs air to the side and center vents.

1. Move the air control dial to the  position.

2. Turn the fan control dial to select speed.
3. Move the temperature control dial to the desired position.

## Defrosting or defogging

This mode is used to defrost/defog the windows.

1. Move the air control dial to the  position.
2. Turn the fan control dial to select speed.
3. Move the temperature control dial to the desired position.

When the  position is selected, the air conditioner automatically turns on (however, the indicator light will not illuminate) if the outside temperature is more than 45°F (7°C). This dehumidifies the air which helps defog the windshield. The air recirculation mode automatically turns off, allowing outside air to be drawn into the passenger compartment which helps defog the windshield.

## Operating Tips

**Clear snow and ice from the wiper blades and air inlet in front of the windshield. This improves defrosting/defogging operation.**

### Bi-level heating/cooling

The bi-level mode directs air to the side and center vents and to the front and rear floor outlets.

Bi-level is also a cooling mode when high sun load conditions are present with cool temperatures.

With the A/C system in operation, this mode can be used to cool the passenger's or driver's feet under high temperature conditions.

With the A/C system in operation under high temperature conditions, improved cooling can be obtained by moving the air control dial to the MAX A/C position.

1. Move the air control dial to the  position.
2. Turn the fan control dial to the desired position.

3. Move the temperature control dial to the desired position.

### Heating and defogging

This mode heats the interior and defogs the windshield. This mode directs air to the defroster and the front and rear floor outlets. Rear passenger heat is provided by the front system through floor outlets located under both front seats.

1. Move the air control dial to the  position.
2. Turn the fan control dial to the desired position.
3. Move the temperature control dial to the desired position.

When the  position is selected, the air conditioner automatically turns on (however, the indicator light will not illuminate) if the outside temperature is more than 45°F (7°C). This dehumidifies the air which helps defog the windshield. The air recirculation mode automatically turns off, allowing outside air to be drawn into the passenger compartment which helps defog the windshield.

## Operating tips

- **Clear snow and ice from the wiper blades and air inlet in front of the windshield. This improves heater operation.**
- To defog the side windows more effectively when in bi-level or ventilation mode, close the center vent and direct the side vents toward the side windows.
- A slight delay may be experienced when changing air control buttons. This is not a problem, it is only the system motors and solenoids switching from one outlet to another.

### AIR CONDITIONER OPERATION

Start the engine, move the fan control dial to the desired (one to four) position, and select an air control position before pushing in the air conditioner button to activate the air conditioner. When the air conditioner is on, cooling and dehumidifying functions are added to the heater operation.

#### **WARNING**



**The air conditioner cooling function operates only when the engine is running.**



NOTE: When switching air flow outlets, the A/C system remains activated unless the A/C button is pressed to the OFF position. The indicator light on the A/C button remains illuminated unless the button is pressed to the OFF position, or the OFF air control position is selected.

## Cooling

This mode is used to cool and dehumidify.

1. Move the air control dial to the  position.
  2. Turn the fan control dial to select speed.
  3. Push the air conditioner button. The indicator light comes on.
  4. Move the temperature control dial to the desired position.
- For quick cooling when the outside temperature is high, move the air control dial to the MAX A/C position. Be sure to return the air control dial to the  position for normal cooling.
  - Opening the windows helps to vent heat buildup when parked in the sun.

## Dehumidified heating

This mode is used to heat and dehumidify.

1. Move the air control dial to the  position.
2. Turn the fan control dial to select speed.
3. Push the air conditioner button. The indicator light comes on.
4. Move the temperature control dial to the desired position.

## Dehumidified defogging

This mode is used to defog the windows and dehumidify.

1. Move the air control dial to the  position.
2. Turn the fan control dial to the desired speed.
3. Move the temperature control dial to the desired position.

When the  position is selected, the air conditioner automatically turns on (however, the indicator light will not illuminate) if the outside temperature is more than 45°F (7°C). This dehumidifies the air which helps defog the windshield.

The air recirculation mode automatically turns off, allowing outside air to be drawn into the passenger compartment which helps defog the windshield.

## Operating tips

- Keep windows and sun roof closed while the air conditioner is in operation.
- After parking in the sun, drive for two or three minutes with the windows open to vent hot air from the passenger compartment. Then, close the windows. This allows the air conditioner to cool the interior more quickly.
- **The air conditioning system should be operated for about ten minutes at least once a month. This helps prevent damage to the system due to lack of lubrication.**
- If the engine coolant temperature gauge exceeds the H (hot) position, turn the air conditioner off. See “If your vehicle overheats” in the “In case of emergency” section for additional information.

## AIR FLOW CHARTS

The following charts show the button and dial positions for **MAXIMUM AND QUICK** heating, cooling or defrosting.

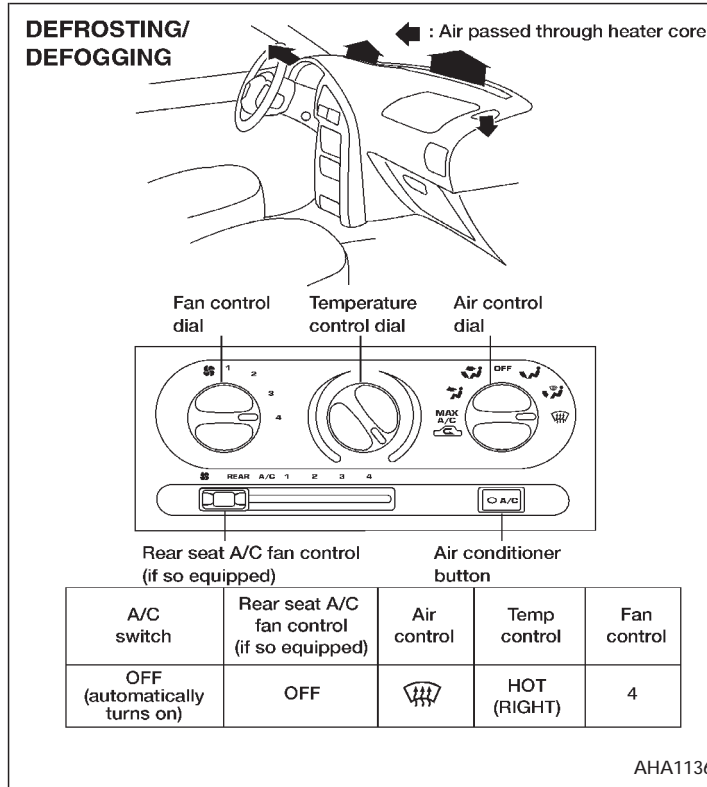

## BI-LEVEL HEATING

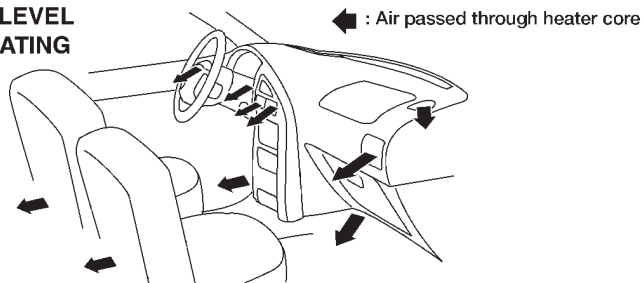

Fan control dial      Temperature control dial      Air control dial

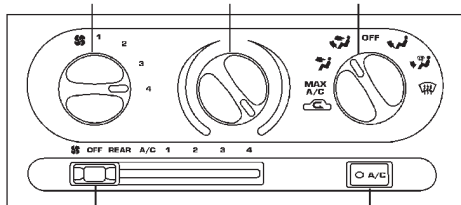

Rear seat A/C fan control  
(if so equipped)

Air conditioner  
button

A/C switch	Rear seat A/C fan control (if so equipped)	Air control	Temp control	Fan control
OFF	OFF		HOT (RIGHT)	4

AHA1137

## HEATING

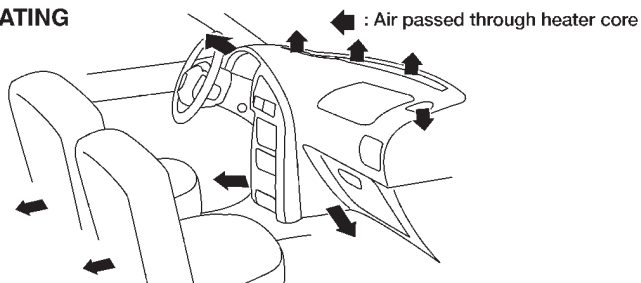

Fan control dial      Temperature control dial      Air control dial

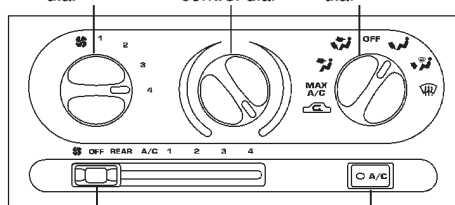

Rear seat A/C fan control  
(if so equipped)

Air conditioner  
button

A/C switch	Rear seat A/C fan control (if so equipped)	Air control	Temp control	Fan control
OFF	OFF		HOT (RIGHT)	4

AHA1138

## HEATING & DEFROSTING/ DEFOGGING

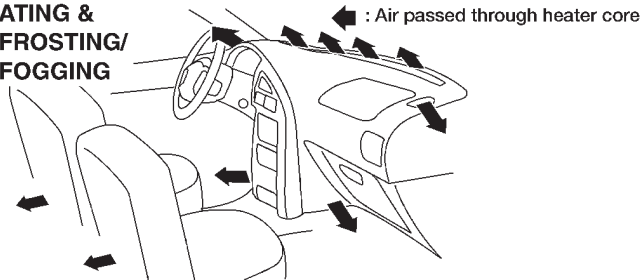

Fan control dial      Temperature control dial      Air control dial

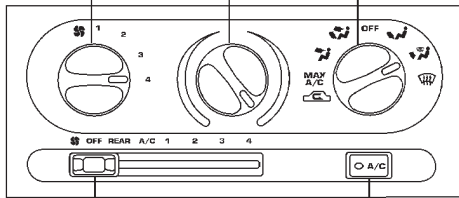

Rear seat A/C fan control (if so equipped)

Air conditioner button

A/C switch	Rear seat A/C fan control (if so equipped)	Air control	Temp control	Fan control
OFF	OFF		HOT (RIGHT)	4

AHA1139

## COOLING

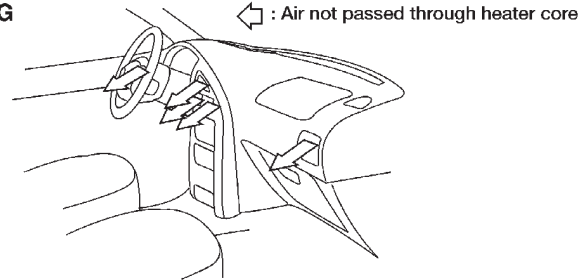

Fan control dial      Temperature control dial      Air control dial

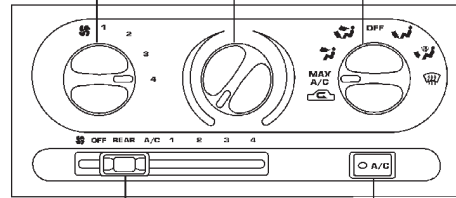

Rear seat A/C fan control (if so equipped)

Air conditioner button

A/C switch	Rear seat A/C fan control (if so equipped)	Air control	Temp control	Fan control
OFF (automatically turns on)	REAR A/C	MAX A/C	COOL (LEFT)	4

AHA1140

## COOLING

← : Air not passed through heater core

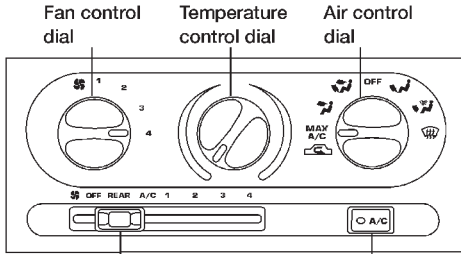
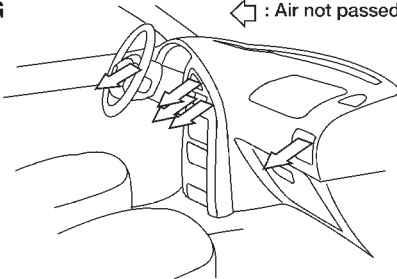

Rear seat A/C fan control

Air conditioner  
button

A/C switch	Rear seat A/C fan controls	Air control	Temp control	Fan control
OFF (automatically turns on)	REAR A/C	MAX A/C 	COOL (LEFT)	4

## REAR SEAT A/C FAN CONTROLS

← : Air not passed through heater core

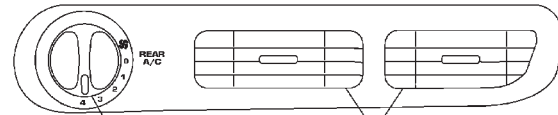
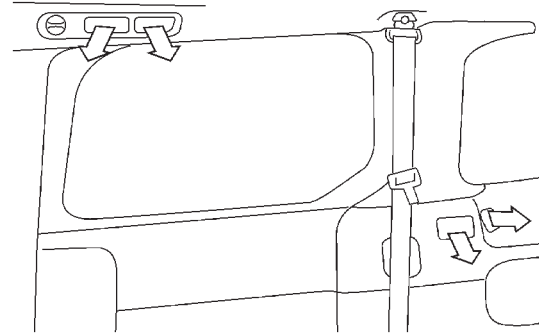

Fan control dial

2nd row ventilators

Fan control
4

AHA1141

## HEATER AND AIR CONDITIONER (automatic) (if so equipped)

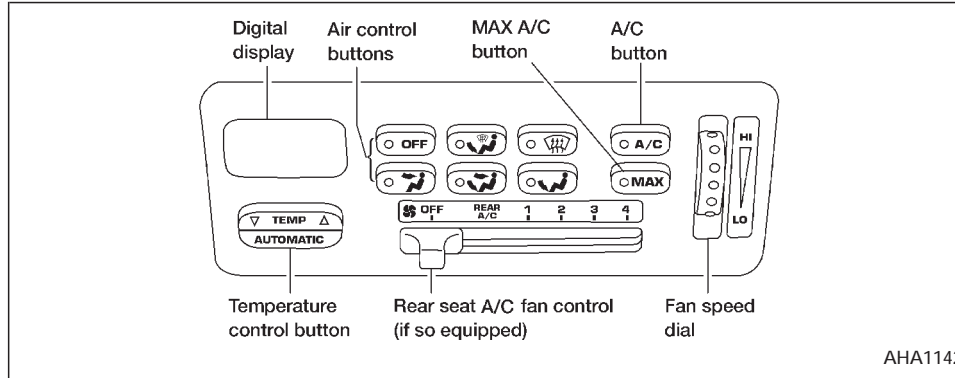

### WARNING

- The air conditioner cooling function operates only when the engine is running.
- Do not leave children, unreliable adults, or pets alone in your vehicle. On hot, sunny days, temperatures in a closed vehicle could quickly become high enough to cause severe or possibly fatal injuries to people or animals.
- Do not use the MAX mode for long periods as it may cause the interior

### air to become stale and the windows to fog up.





- Positioning of the heater and air conditioner controls should not be done while driving, in order that full attention may be given to the driving operation.

The cabin air filter (if so equipped) requires periodic maintenance. See the "Do it yourself" section for additional information.

The Electronic Automatic Temperature Control (EATC) is located at the center of the instrument panel, below the radio. The

EATC operates only when the ignition is turned to the ON position.

The EATC maintains the temperature you select and controls the airflow for your comfort. It also allows you to override the automatic operation with manual function selector buttons.

To turn the EATC on, push either the AUTOMATIC button or any of the six function selector buttons: , , , ,  or MAX. To turn the EATC off, press the OFF button.

When you select AUTOMATIC, the system determines fan speed, airflow location and discharge air temperature. When one of the function selector buttons is pressed, your selection determines airflow location only. Fan speed and discharge air temperature remain automatic. You can override fan speed by rotating the vertical thumbwheel  located at the extreme right of the control panel.

The display window indicates the status of the system. It shows the selected temperature and AUTO when in the AUTOMATIC mode. It also indicates manual (thumbwheel) control of the fan speed when a  is shown.

## AUTOMATIC OPERATION

Push the AUTOMATIC button and select the desired temperature. The selected temperature and AUTO show in the display window. The EATC heats or cools to achieve the set temperature.

When in AUTOMATIC and weather conditions require heat, air is sent to the floor. However, a feature is included in the EATC to prevent blowing cold air to the floor if the engine coolant is not warm enough to allow heating. In three or four minutes the fan speed gradually increases and airflow changes to the floor.

If unique conditions exist, such as window fogging, the five override buttons allow specific airflow selection. The thumbwheel allows you to adjust the fan speed to suit your needs.

### Temperature selection

The ▼ TEMP ▲ button on the left side of the control panel is for temperature selection. The ▼ side lowers the set temperature, and the ▲ side raises the set temperature. Press and hold either side of the button to rapidly change the temperature setting in one degree increments to either 65°F (18°C) or 85°F (29°C). If you want

continuous maximum cooling, push the ▼ side of the TEMP button until 60°F (16°C) shows in the display window. The EATC cools at maximum and disregards the 60°F (16°C) setting until a warmer temperature is selected. If you want continuous maximum heating, push the ▲ side of the TEMP button until 90°F (32°C) shows in the display window. The EATC provides maximum heat regardless of the 90°F (32°C) setting until a cooler temperature is selected.

### Fan speed and thumbwheel

Your EATC automatically adjusts the fan speed to the existing conditions. To control the fan speed yourself, use the thumbwheel located at the extreme right side of the EATC control panel. Using the thumbwheel cancels the automatic fan speed control, and causes a ⚙️ to appear in the display window. Rotate the thumbwheel up for HI speeds and down for LO speeds.

To return to auto fan control, press the AUTOMATIC button.

## AIR CONTROL BUTTONS

Your EATC has five buttons which allow you to make special selections. The buttons are

grouped in the middle of the EATC panel and allow you to determine airflow location. Pressing any of the air control buttons changes airflow location only, and does not affect the ability of the system to control temperature or fan speed. Return to fully automatic operation by pushing the AUTOMATIC button.



Push this button for airflow to the front and rear floor outlets and windshield at the same time. The 🌀 indicator light comes on, and the display window shows the set temperature.



Press this button to obtain maximum airflow to the windshield. Adjust the temperature setting as required for defrosting. The 🌀 indicator light comes on, and the display window shows the set temperature. When the outside temperature is about 45°F (7°C) or above, the air is dehumidified to prevent window fogging.



Push this button to select airflow through

the instrument panel registers. The  indicator light comes on, and the display window shows the set temperature. The EATC heats the air if the selected temperature is warmer than the outside air coming into the vehicle. However, the air is not cooled regardless of the temperature setting, unless the A/C button is selected.



Push this button to get air from the front and rear floor outlets and instrument panel ventilators at the same time. The  indicator light comes on and the display window shows the set temperature. The EATC heats the air if the selected temperature is warmer than the outside air coming into the vehicle. However, the air is not cooled regardless of the temperature setting, unless the A/C button is selected.



Push this button to direct airflow to the front and rear floor outlets. The  indicator light comes on, and the display window shows the set temperature. The EATC heats the air if the selected temperature is warmer than the outside air coming into the

vehicle. However, the air is not cooled regardless of the temperature setting, unless the A/C button is selected.

### MAX

Press the MAX button to choose air recirculation. In this mode the EATC system recirculates the air inside the vehicle rather than drawing air from outside. Air is distributed through the instrument panel ventilators similar to  mode. Use this mode to rapidly cool the inside of the vehicle, or to dehumidify the air inside the vehicle.

### A/C

Activate the air conditioner in any of the override modes listed above by pressing the A/C button. The A/C indicator light comes on to verify activation, and cooled air flows from the vents. Fan speed continues to be controlled by the EATC unless the fan speed thumbwheel is used to override.

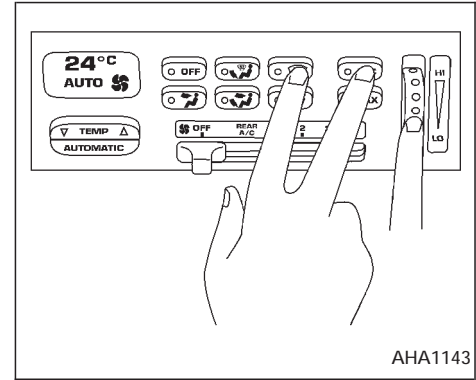

### ENGLISH/METRIC MODE

Switch from English to metric temperature display by simultaneously pressing the  and A/C buttons and holding the thumbwheel in upper position (HI) for one second.



## REAR SEAT AIR CONDITIONER (if so equipped)

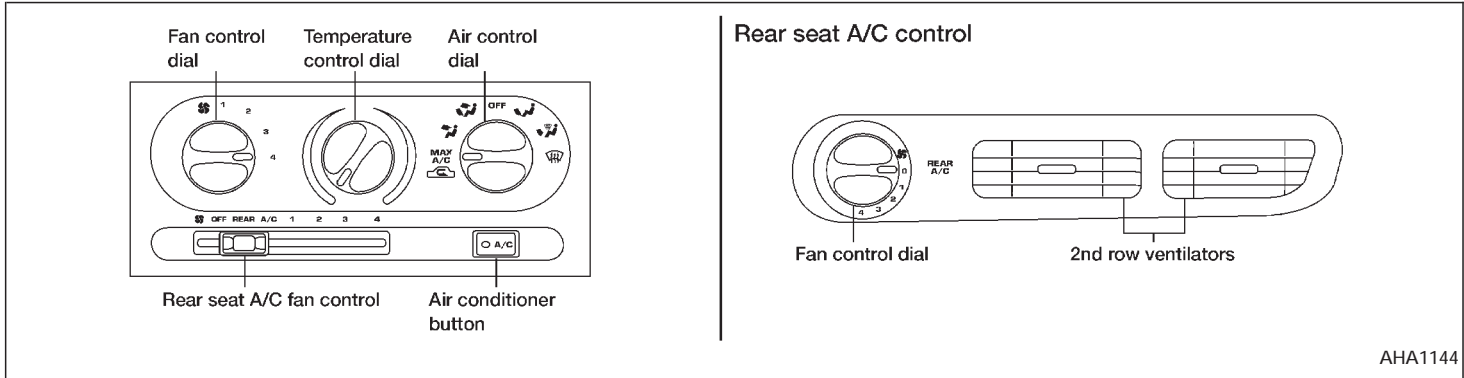

AHA1144

To operate the rear seat air conditioner, the engine must be running.

The rear seat air conditioner can be turned on and off from the front controls. If the rear seat fan control lever on the front panel is set to OFF, the rear air conditioner is turned off. If it is set to any of the fan speed positions, air is discharged from the rear vents at the corresponding speed. When the rear seat fan control lever on the front panel is set to REAR A/C, the rear seat passengers control their own fan speed.

The rear seat air conditioner only works when the front seat air conditioner is operating.

### 4-14 Heater, air conditioner and audio systems

## CONTROLS

### Fan control dial

This dial turns the fan on and off, and controls fan speed.

### Servicing air conditioning

The air conditioning system in your NISSAN vehicle is charged with a refrigerant designed with the environment in mind.

**This refrigerant does not harm the earth's ozone layer.**

Special charging equipment and lubricant

are required when servicing your NISSAN air conditioner. Using improper refrigerants or lubricants causes severe damage to your air conditioning system. See "Air conditioning system refrigerant and lubricant recommendations" in the "Technical and consumer information" section of this manual.

An authorized NISSAN dealer is able to service your environmentally "friendly" air conditioning system.

 **WARNING**

The air conditioner system contains refrigerant under high pressure. To avoid personal injury, any air conditioner service should be done by an experienced technician with proper equipment.

# AUDIO SYSTEM

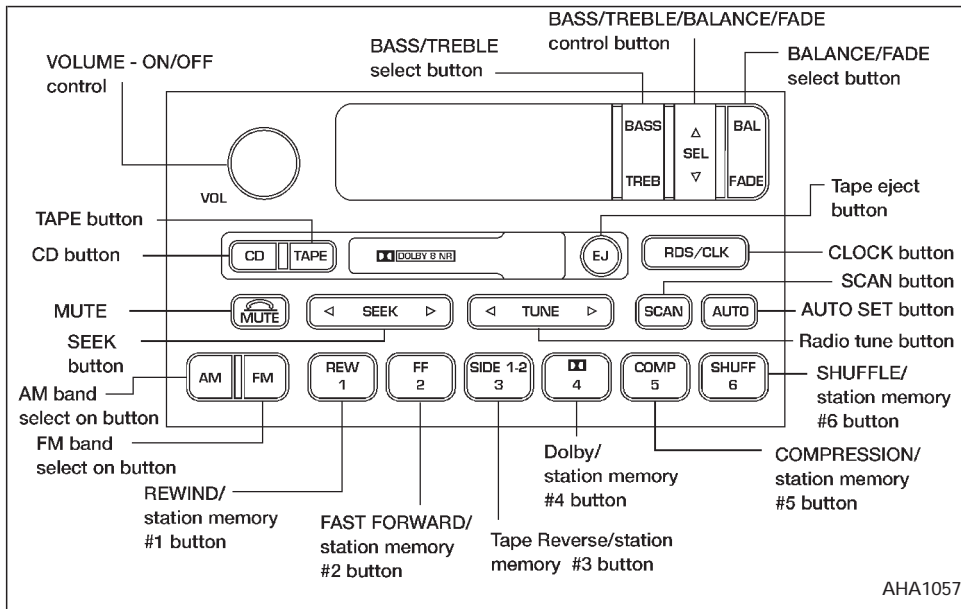

## AM-FM RADIO WITH CASSETTE PLAYER

### RADIO OPERATION

To turn the radio on, turn the ignition key to ACC or ON. If you listen to the radio with the

engine not running, turn the key to the ACC position.

Radio reception is affected by station signal strength, distance from radio transmitter, buildings, bridges, mountains, and other external influences. Intermittent changes in

reception quality normally are caused by external influences.

**Using a cellular phone in or near the vehicle may influence radio reception quality.**

Push the VOL knob to turn the radio on. Push the VOL knob once more to turn the radio OFF.

Turn the knob to raise or lower volume. If the knob is set above a certain volume level and the ignition is turned off, the volume will come back on at a nominal listening level when the ignition is turned back on.

### MUTE button

Push the MUTE button to mute out the radio.

### Clock operation

The clock is on in the display regardless of what mode, media, or function the radio is in as long as the ignition is in ACC or ON.

### Clock set

Press the RDS/CLK button until SELECT HOURS is displayed then use the SEL ▲ ▼ buttons to change the hour, press the RDS/CLK button again until SELECT

MINS is displayed then use the SEL ▲ ▼ buttons to change the minutes. The display will return to clock priority mode in 10 seconds or press the RDS/CLK button to return to the clock display.

### Selecting the desired band

Push the AM or FM buttons to change to AM or FM band reception.

The FM stereo indicator, ST illuminates during FM stereo reception. When the stereo broadcast signal is weak, the radio automatically changes from stereo to monaural reception.

## TUNING

### WARNING

**The radio should not be tuned while driving in order that full attention may be given to the driving operation.**

### Auto set

Press the AUTO button while listening to the radio to activate the auto set feature. When AUTO is depressed for less than 5 seconds, the display window momentarily indicates AUTO ON, and the radio seeks the first six strong stations for the respective band. The



first six strong stations are then stored in order in memory buttons one through six.

Only stations in the selected band are set, and the station seek begins from the last frequency stored in memory button six. If AM, FM, SCAN, TUNE, SEEK, AUTO or a memory button is pushed while auto set is operating, auto set is canceled and AUTO OFF shows in the display window.





### Auto load

Press the AUTO button for longer than 5 seconds while listening to the radio to activate the auto load feature. When AUTO is depressed for longer than 5 seconds, the display window momentarily indicates AUTO LOAD, and the radio seeks the first six strong stations for every band. The first six strong stations are then stored in order in memory buttons one through six for each band (AM, FM1, and FM2).

### Tune buttons

Use the  or  buttons for manual tuning. To move quickly through the channels, hold either of the tune buttons down for more than 0.5 seconds.

### SEEK tuning

Push the SEEK  or  buttons to find the next broadcast station. Pushing the  SEEKS up and  button SEEKS down. Pushing the button again continues the SEEK function. Once the highest broadcast station is reached, the radio continues in the SEEK mode at the lowest station. Once the lowest broadcast station is reached, the radio continues in the SEEK mode at the highest station.

### SCAN tuning

Push the SCAN tuning button, SCAN illuminates in the display. SCAN tuning begins from low to high frequencies and stops at each broadcasting station for 5 seconds. Pushing the button again during this 5 second period stops SCAN tuning and remains tuned to that station.

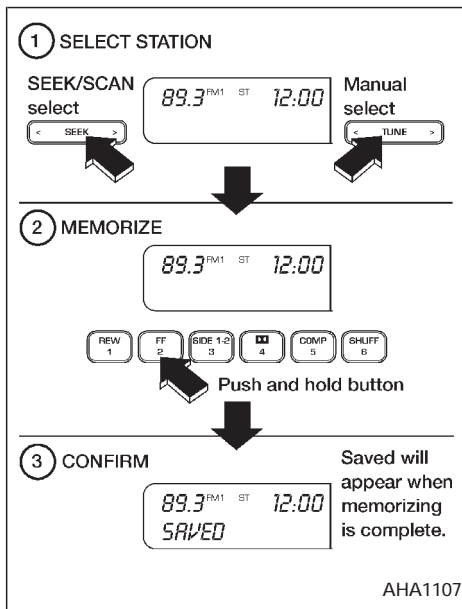

## Station memory operation

Six stations can be set for the AM band. Twelve stations can be set for the FM band (six for FM1, six for FM2).

1. Push the FM or AM buttons to select AM,

FM1, or FM2. The selected band illuminates in the display.

2. Tune to the desired station.

3. Push the desired station select button for more than 1.5 seconds. The radio mutes when the select button is pushed.

4. When the sound resumes, memorizing is complete.

5. Other station select buttons can be set in the same manner.

If the battery is disconnected, or if the radio fuse opens, the radio memory is canceled. In that case, reset the desired stations.

## RDS (Radio Data System)

RDS stands for Radio Data System, and is a data information service transmitted by some radio stations on the FM band (not AM band) encoded within a regular radio broadcast. Most RDS stations are currently in large cities, but many stations are now considering broadcasting RDS data.

RDS can display:

- Station name or call-sign, such as "WHFR 98.3".

- Music or programming type such as "Classical", "Country", or "Rock".

- Text Messages such as telephone numbers for dial in requests, advertisements and other simple messages.

- Traffic reports about delays or construction.

## Using RDS

To turn RDS on push the RDS/CLK button until RDS OFF is displayed, then press the SEL button until RDS ON is displayed.

To change display type turn RDS ON then use the SEL button to choose between:

- SHOW TYPE - Music or program type.
- SHOW NAME - Station name or call-sign.
- SHOW TEXT - Text Messages such as telephone numbers for dial in requests, advertisements and other simple messages.
- SHOW NONE - No text display.

To choose traffic reports press the RDS/CLK button until TRAFFIC OFF is displayed, the use then SEL button to choose

TRAFFIC ON, then use the seek or scan control to look for a station that may transmit traffic reports, the radio will display a “TRAF” icon to show it is in traffic mode and tuned to a station that may transmit traffic reports. If the radio searches through the whole band and then returns to the previous station it was originally playing there are no stations in the area that are transmitting traffic reports.

If a cassette or compact disc is being played while the traffic option is on and the station previously tuned into displays a traffic bulletin the radio will pause the cassette or compact disc and broadcast the bulletin, then resume playing the cassette or compact disc.

## Using RDS to search for programming type

Certain areas have a limited number of stations that transmit RDS. Many stations transmit call letters and frequencies only. Searching or scanning by program type may yield a limited number of selections.

Press the RDS/CLK button until FIND CLASSIC is displayed, then use the SEL button to choose between CLASSIC,

COUNTRY, INFO, JAZZ, OLDIES, R&B, RELIGUS (Religious), ROCK, SOFT and TOP40. When you have chosen a program type, use the SEEK, SCAN, or AUTOSSET controls to look for a station transmitting that kind of program. If the radio searches through the whole band and then returns to the previous station it was originally playing there are no stations in the area that are transmitting that type of programming.

## Adjusting tone quality and speaker balance

### Bass

Bass control allows you to adjust the lower, bass frequencies to your preference.

Push the BASS button and the setting indicator bar appears in the display window. Pressing the SELECT button either ▲ or ▼ increases or decreases the level of bass, as indicated by the number of bar segments showing in the display window.

Following bass adjustment, the display window shows the current setting for three seconds, then returns to the display prior to adjustment.

### Treble

Treble control allows you to adjust the higher, treble frequencies to your preference.

Push the TREB button and the setting indicator bar appears in the display window. Pressing the SELECT button either ▲ or ▼ increases or decreases the level of bass, as indicated by the number of bar segments showing in the display window.

Following bass adjustment, the display window shows the current setting for three seconds, then returns to the display prior to adjustment.

### Balance

Balance control allows you to adjust the sound distribution between the right and left speakers.

Push the BAL button and the setting indicator bar appears in the display window. Press the SELECT button ▲ to shift the sound to the right speakers. The single indicator bar moves to the right of the display window. Press the SELECT button ▼ to shift the sound to the left speakers. The single indicator bar moves to the left of the display

window. When the indicator bar is in the center position the sound is equally distributed between the right and left speakers.

Following balance adjustment, the display window shows the current setting for three seconds, then returns to the display prior to adjustment.

## Fader

Fader control allows you to adjust sound distribution between the front and rear speakers.

Push the FADE button and the setting indicator bar appears in the display window. Press the SELECT button ▲ to shift the sound to the front speakers. The single indicator bar moves to the right of the display window. Press the SELECT button ▼ to shift the sound to the rear speakers. The single indicator bar moves to the left of the display window. When the indicator bar is in the center position the sound is equally distributed between the front and rear speakers.

Following fader adjustment, the display window shows the current setting for three seconds, then returns to the display prior to adjustment.

## 4-20 Heater, air conditioner and audio systems

## COMP button

Press this button to activate the compression function. This reduces the dynamic range, which provides the listener with a more consistent level of volume. The display window shows a C when the COMP button is pushed.

## CASSETTE TAPE OPERATION

Turn the ignition to ACC or ON, and carefully insert a cassette tape into the tape door. The cassette tape automatically pulls into the player and begins to play.

When a cassette is inserted into the audio system, the word TAPE and a cassette side symbol (either one or two) illuminates in the display.

If the radio is already operating it automatically turns off and the cassette tape begins to play. The cassette tape automatically changes direction to play the other side when the first side is complete.

## Precautions on cassette player operation

- **To maintain good quality sound, Nissan recommends using cassette tapes**

**of 60 minutes or shorter in length.**

- **Cassette tapes should be removed from the player when not in use. Store cassettes in their protective cases and away from direct sunlight, heat, dust, moisture, and magnetic sources.**
- **Direct sunlight can cause the cassette to become deformed. The use of deformed cassettes may cause the cassette to jam in the player.**
- **Do not use cassettes with loose labels which are peeling and loose. If used the label could jam in the player.**
- **If a cassette has loose tape, insert a pencil through one of the cassette hubs and rewind the tape firmly around the hubs. Loose tape may cause tape jamming and wavering sound quality.**
- **Over a period of time, the playback head, capstan and pinch roller may collect a tape coating residue as the tape is played. This residue accumulation can cause weak or wavering sound, and should be removed periodically with a head cleaning tape. If the residue is not removed periodi-**

**cally, the player may need to be disassembled for cleaning.**

## REW and FF

Push the REW or FF button for the desired direction.

The FF or REW symbol illuminates in the display.

To stop the FF or REW function, press the FF or REW button again or the TAPE button.

## Automatic Music Search (AMS)

Pushing the seek button while playing a cassette tape activates the Automatic Music Search (AMS) mode. Press ◀ SEEK to rewind the tape to the previous selection, or press SEEK ▶ to forward the tape to the next selection.

This system searches for the blank intervals between selections. If there is a blank interval within one program or there is no interval between programs, the system may not stop in the desired or expected location.



## Changing the direction of tape play

Push the SIDE 1-2 select button to switch sides on the tape. The display will change from TAPE 1 PLAY to TAPE 2 PLAY.

## Playing and stopping the cassette tape

Push the TAPE button while the cassette tape is playing to stop the tape. Push the button again to play the tape.

## Dolby NR (noise reduction)

Push the  button for Dolby NR encoded tapes to reduce high frequency tape noise. When activated, a  appears in the display window.

Dolby NR is manufactured under license from Dolby Laboratories Licensing Corporation. "Dolby NR" and the double-D symbol are trademarks of Dolby Laboratories Licensing Corporation.

## Metal or chrome tape usage

The cassette player is automatically set to high performance play when playing a metal or chrome tape.

## Ejecting the cassette tape

Push the EJ button. The cassette tape automatically comes out.



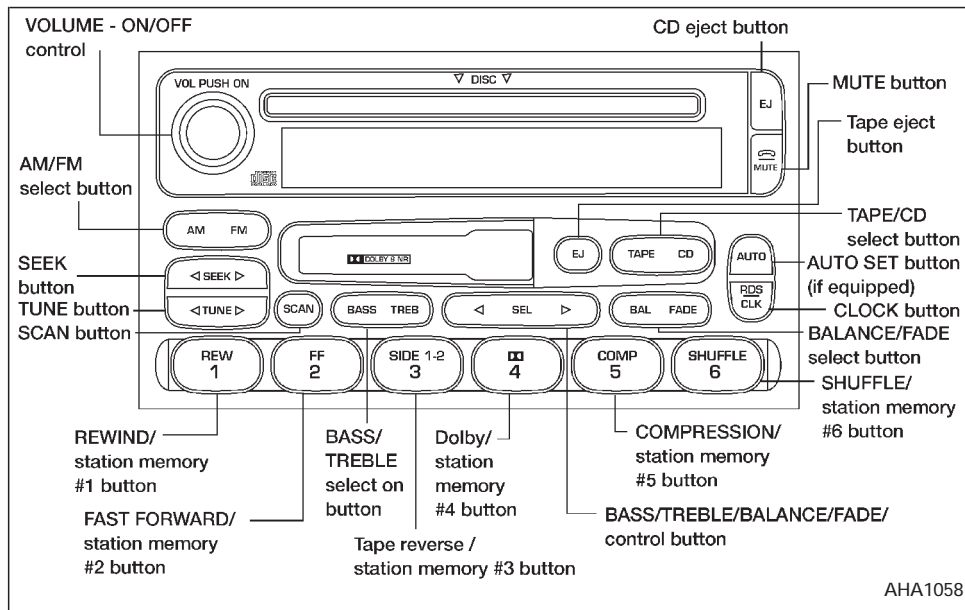

AHA1058

## AM-FM RADIO WITH CASSETTE PLAYER AND COMPACT DISC PLAYER

### RADIO OPERATION

#### 4-22 Heater, air conditioner and audio systems

To turn the radio on, turn the ignition key to ACC or ON. If you listen to the radio with the engine not running, turn the key to the ACC position.

Radio reception is affected by station signal strength, distance from radio transmitter,

buildings, bridges, mountains, and other external influences. Intermittent changes in reception quality normally are caused by external influences.

**Using a cellular phone in or near the vehicle may influence radio reception quality.**

Push the VOL knob to turn the radio on. Push the VOL knob once more to turn the radio OFF.

The control buttons are illuminated when the parking lamps or headlamps are on. Only the text for the active controls will illuminate for each specific type of media. No bulbs or lights have malfunctioned. For example when a cassette tape is being played, SHUFFLE will not illuminate.

Turn the knob to raise or lower volume. If the knob is set above a certain volume level and the ignition is turned off, the volume will come back on at a nominal listening level when the ignition is turned back on.

### Clock operation

The clock is on in the display regardless of what mode, media, or function the radio is in as long as the ignition is in ACC or ON.

## Clock set

Press the RDS/CLK button until SELECT HOURS is displayed then use the SEL ◀ ▶ buttons to change the hour, press the RDS/CLK button again until SELECT MINS is displayed then use the SEL ◀ ▶ buttons to change the minutes. The display will return to the previous radio station, tape or CD that was being played previous to setting the clock in 7 seconds or you may press the RDS/CLK button until the previous display appears.

## Selecting the desired band

Push the AM buttons to change to AM band or push the FM button to change to FM1 or FM2 band reception.

The FM stereo indicator, ST illuminates during FM stereo reception. When the stereo broadcast signal is weak, the radio automatically changes from stereo to monaural reception.

## TUNING

### WARNING

**The radio should not be tuned while driving in order that full attention may be given to the driving operation.**

## Auto set

Press the AUTO button while listening to the radio to activate the auto set feature. When AUTO is depressed for less than 5 seconds, the display window momentarily indicates AUTO ON, and the radio seeks the first six strong stations for the respective band. The first six strong stations are then stored in order in memory buttons one through six.

Only stations in the selected band are set, and the station seek begins from the last frequency stored in memory button six. If AM, FM, SCAN, TUNE, SEEK, AUTO or a memory button is pushed while auto set is operating, auto set is canceled and AUTO OFF shows in the display window.

## Auto load

Press the AUTO button for longer than 5 seconds while listening to the radio to acti-

vate the auto load feature. When AUTO is depressed for longer than 5 seconds, the display window momentarily indicates AUTO LOAD, and the radio seeks the first six strong stations for every band. The first six strong stations are then stored in order in memory buttons one through six for each band (AM, FM1, and FM2).

## Tune buttons ◀ ▶

Use the ◀ or ▶ buttons for manual tuning. To move quickly through the channels, hold either of the tune buttons down for more than 0.5 seconds.

## SEEK tuning

Push the SEEK ◀ or ▶ buttons to find the next broadcast station. Pushing the ◀ SEEKS up and ▶ button SEEKS down. Pushing the button again continues the SEEK function. Once the highest broadcast station is reached, the radio continues in the SEEK mode at the lowest station. Once the lowest broadcast station is reached, the radio continues in the SEEK mode at the highest station.

## SCAN tuning

Push the SCAN tuning button, SCAN illuminates in the display. SCAN tuning begins from low to high frequencies and stops at each broadcasting station for 5 seconds. Pushing the button again during this 5 second period stops SCAN tuning and remains tuned to that station.

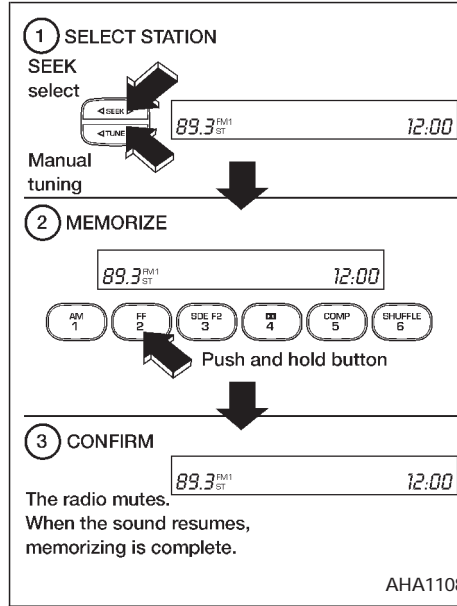

## Station memory operation

Six stations can be set for the AM band. Twelve stations can be set for the FM band (six for FM1, six for FM2).

1. Push the FM or AM buttons to select AM,

FM1, or FM2. The selected band illuminates in the display.

2. Tune to the desired station.
3. Push the desired station select button for more than 1.5 seconds. The radio mutes when the select button is pushed.
4. When the sound resumes, memorizing is complete.
5. Other station select buttons can be set in the same manner.

If the battery is disconnected, or if the radio fuse opens, the radio memory is canceled. In that case, reset the desired stations.

## RDS (Radio Data System)

RDS stands for Radio Data System, and is a data information service transmitted by some radio stations on the FM band (not AM band) encoded within a regular radio broadcast. Most RDS stations are currently in large cities, but many stations are now considering broadcasting RDS data.

RDS can display:

- Station name or call-sign, such as "WHFR 98.3".

- Music or programming type such as “Classical”, “Country”, or “Rock”.
- Text Messages such as telephone numbers for dial in requests, advertisements and other simple messages.
- Traffic reports about delays or construction.

## Using RDS

To turn RDS on push the RDS/CLK button until RDS OFF is displayed, then press the SEL button until RDS ON is displayed.

To change display type turn RDS ON then use the SEL button to choose between:

- SHOW TYPE - Music or program type.
- SHOW NAME - Station name or call sign.
- SHOW TEXT - Text Messages such as telephone numbers for dial in requests, advertisements and other simple messages.
- SHOW NONE - No text display.

To choose traffic reports press the RDS/CLK button until TRAFFIC OFF is displayed, the use then SEL button to choose

TRAFFIC ON, then use the seek or scan control to look for a station that may transmit traffic reports, the radio will display a “TRAF” icon to show it is in traffic mode and tuned to a station that may transmit traffic reports. If the radio searches through the whole band and then returns to the previous station it was originally playing there are no stations in the area that are transmitting traffic reports.

If a cassette or compact disc is being played while the traffic option is on and the station previously tuned into displays a traffic bulletin the radio will pause the cassette or compact disc and broadcast the bulletin, then resume playing the cassette or compact disc.

## Using RDS to search for programming type

Certain areas have a limited number of stations that transmit RDS. Many stations transmit call letters and frequencies only. Searching or scanning by program type may yield a limited number of selections.

Press the RDS/CLK button until FIND CLASSIC is displayed, then use the SEL button to choose between CLASSIC,

COUNTRY, INFO, JAZZ, OLDIES, R&B, RELIGUS (Religious), ROCK, SOFT and TOP40. When you have chosen a program type, use the SEEK, SCAN, or AUTASET controls to look for a station transmitting that kind of program. If the radio searches through the whole band and then returns to the previous station it was originally playing there are no stations in the area that are transmitting that type of programming.

## Adjusting tone quality and speaker balance

### Bass

Bass control allows you to adjust the lower, bass frequencies to your preference.

Push the BASS button and the setting indicator bar appears in the display window. Pressing the SELECT button either ◀ or ▶ increases or decreases the level of bass, as indicated by the number of bar segments showing in the display window.

Following bass adjustment, the display window shows the current setting for three seconds, then returns to the display prior to adjustment.

## Treble

Treble control allows you to adjust the higher, treble frequencies to your preference.

Push the TREB button and the setting indicator bar appears in the display window. Pressing the SELECT button either ◀ ▶ increases or decreases the level of bass, as indicated by the number of bar segments showing in the display window.

Following bass adjustment, the display window shows the current setting for three seconds, then returns to the display prior to adjustment.

## Balance

Balance control allows you to adjust the sound distribution between the right and left speakers.

Push the BAL button and the setting indicator bar appears in the display window. Press the SELECT button ▶ to shift the sound to the right speakers. The single indicator bar moves to the right of the display window. Press the SELECT button ◀ to shift the sound to the left speakers. The single indicator bar moves to the left of the display

window. When the indicator bar is in the center position the sound is equally distributed between the right and left speakers.

Following balance adjustment, the display window shows the current setting for three seconds, then returns to the display prior to adjustment.

## Fader

Fader control allows you to adjust sound distribution between the front and rear speakers.

Push the FADE button and the setting indicator bar appears in the display window. Press the SELECT button ◀ to shift the sound to the front speakers. The single indicator bar moves to the right of the display window. Press the SELECT button ▶ to shift the sound to the rear speakers. The single indicator bar moves to the left of the display window. When the indicator bar is in the center position the sound is equally distributed between the front and rear speakers.

Following fader adjustment, the display window shows the current setting for three seconds, then returns to the display prior to adjustment.

## COMP button

Press this button to activate the compression function. This reduces the dynamic range, which provides the listener with a more consistent level of volume. The display window shows COMP when the COMP button is pushed.

## CASSETTE TAPE OPERATION

Turn the ignition to ACC or ON, and carefully insert a cassette tape into the tape door. The cassette tape automatically pulls into the player and begins to play.

When a cassette is inserted into the audio system, the word TAPE illuminates in the display to inform you that there is a tape in the radio.

If the radio is already operating it automatically turns off the CD or radio station and the cassette tape begins to play and TAPE 1 PLAY is displayed. TAPE 1 PLAY indicates side 1 is playing on the tape currently. The cassette tape automatically changes direction to play the other side when the first side is complete and will display TAPE 2 PLAY.

## Precautions on cassette player operation

- To maintain good quality sound, Nissan recommends using cassette tapes of 60 minutes or shorter in length.
- Cassette tapes should be removed from the player when not in use. Store cassettes in their protective cases and away from direct sunlight, heat, dust, moisture, and magnetic sources.
- Direct sunlight can cause the cassette to become deformed. The use of deformed cassettes may cause the cassette to jam in the player.
- Do not use cassettes with loose labels which are peeling and loose. If used the label could jam in the player.
- If a cassette has loose tape, insert a pencil through one of the cassette hubs and rewind the tape firmly around the hubs. Loose tape may cause tape jamming and wavering sound quality.
- Over a period of time, the playback

**head, capstan and pinch roller may collect a tape coating residue as the tape is played. This residue accumulation can cause weak or wavering sound, and should be removed periodically with a head cleaning tape. If the residue is not removed periodically, the player may need to be disassembled for cleaning.**

## REW and FF

Push the REW or FF button for the desired direction.

When REW is pushed TAPE 1 REW illuminates on the display (TAPE 2 REW will illuminate if on side 2). When FF is pushed TAPE 2 FF illuminates on the display (TAPE 2 FF will illuminate if on side 2). To stop the FF or REW function, press the FF or REW button again or the TAPE button.

## Automatic Music Search (AMS)

Pushing the seek button while playing a cassette tape activates the Automatic Music Search (AMS) mode. Press ◀ SEEK to rewind the tape to the previous selection, or press SEEK ▶ to forward the tape to the next selection.

This system searches for the blank intervals between selections. If there is a blank interval within one program or there is no interval between programs, the system may not stop in the desired or expected location.



## Changing the direction of tape play

Push the SIDE 1-2 select button to switch sides on the tape. The display will change from TAPE 1 PLAY to TAPE 2 PLAY.

## Playing and stopping the cassette tape

Push the CD, AM, or FM button while the cassette tape is playing to stop the tape. Push the button again to play the tape.

## Dolby NR (noise reduction)

Push the  button for Dolby NR encoded tapes to reduce high frequency tape noise. When activated, a  appears in the display window.

Dolby NR is manufactured under license from Dolby Laboratories Licensing Corporation. "Dolby NR" and the double-D symbol are trademarks of Dolby Laboratories Licensing Corporation.

## COMPACT DISC (CD) PLAYER OPERATION

### Metal or chrome tape usage

The cassette player is automatically set to high performance play when playing a metal or chrome tape.

### Ejecting the cassette tape

Push the EJ button. The cassette tape automatically come out.

Turn the ignition key to the ACC or ON position and carefully insert the compact disc into the slot with the label side up. The compact disc is automatically pulled into the slot and starts to play.

If the radio or cassette tape is already operating, it automatically turns off and the compact disc begins to play.

### CAUTION

**Do not force the compact disc into the slot. This could damage the player.**

### TAPE/CD button

When the CD side of the TAPE/CD button is pushed with the compact disc loaded and the tape or the radio playing, the tape or radio turns off and the compact disc start to play.

### FF and REW button

When the FF or REW button is pushed while the compact disc is playing, the compact disc plays at an increased speed while fast forwarding or rewinding. When the button is released, the compact disc returns to normal play speed.

### SEEK ◀ or ▶ button

When the SEEK ▶ button is pushed while the compact disc is playing, the next selection following the present one starts to play from the beginning. Push the SEEK ▶ button several times to skip several selections. Each time the button is pushed, the CD advances one additional selection. The number appears in the display window. (When the last selection on the compact disc is skipped, the first selection is played.)

When the SEEK ◀ button is pushed, the selection being played returns to the beginning. Push the SEEK ◀ button several times to skip back several selections. Each time the button is pushed, the CD moves back one selection.

### SHUFFLE button

When the SHUFFLE button is pressed the tracks on the CD are played at random, not following the sequence on the compact disc. The same program may be repeated twice.

### CD eject button

When the EJ button is pushed with a compact disc loaded, the compact disc ejects.

## ANTENNA

When the EJ button is pushed while the compact disc is playing, the disc ejects and the system turns off.

If the compact disc ejects and is not removed within 10 seconds, it is pulled back into the slot.

### DISC indicator light

DISC illuminates when a compact disc is loaded into the player.

#### CAUTION

- **During cold weather or rainy days, the player may malfunction due to the humidity. If this occurs, remove the CD and dehumidify or ventilate the player completely.**
- **The player may skip while driving on rough roads.**
- **The CD player sometimes cannot function when the compartment temperature is extremely high. Decrease the temperature before use.**
- **Do not expose the CD to direct sunlight.**

The manual antenna on your vehicle remains in the up position at all times. The antenna cannot be shortened, but can be removed. When you need to remove the antenna, turn the antenna rod counterclockwise.

To install the antenna rod, turn the antenna clockwise. Tighten the antenna rod to specification using a suitable tool such as an open-end wrench. The antenna rod tightening specification is 3.4 - 3.6 N·m (30 - 32 in·lb). Do not use pliers to tighten the antenna as they can leave marks on the antenna surface. The antenna rod can not be hand tightened to the proper specification.

#### CAUTION

**Always properly tighten the antenna rod during installation or the antenna rod may break during vehicle operation.**



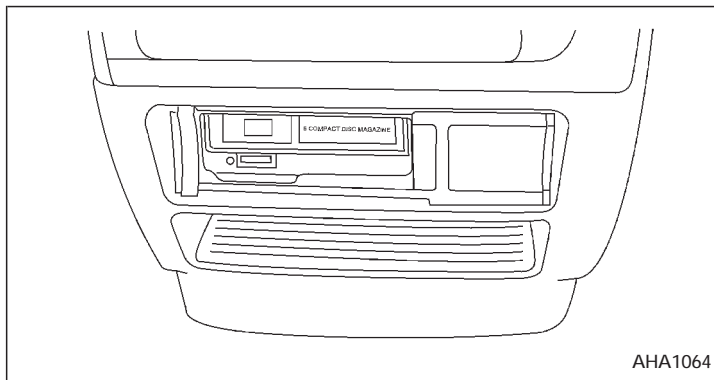

## COMPACT DISC (CD) PLAYER (if so equipped)

NOTE: Audio control features include command buttons for CD players which can be installed as optional equipment to upgrade the audio system. A CD player is not included with this system, but can be purchased as an option at any time. Consult with an authorized NISSAN dealer for feature availability.

The compact disc player consists of two main components; the 6 CD magazine and the CD changer. Both components are lo-

cated on the center instrument panel console, below the ashtray.

### How to load the CD magazine

To load the magazine with CDs, first push the ▲ button on the CD changer to eject the magazine, then remove the magazine from the changer. The inside of the CD magazine contains six shelves, one for each CD to be loaded. Carefully slide a CD (label side up) onto one of the shelves and push it in. Repeat as desired, loading up to six CDs.

### CD magazine insert

Once the desired number of CDs are loaded into the magazine, insert the magazine back into the CD changer.

With the ignition switch OFF, the CD magazine loads into the CD changer. Once the ignition switch is turned to ACC or ON, the audio system returns to its previous mode.

With the ignition switch in the ACC or ON position, the CD magazine loads into the CD changer and begins play with disc one, track one.

### CD

Push this button to switch from radio or tape mode to CD mode. CD play begins automatically if at least one disc is loaded in the magazine. The display window shows the CD number for three seconds, then the track number for three seconds, then displays both together for the remainder of the track.

If the CD button is pushed while in the radio or tape mode, and there are no CDs loaded in the magazine, the display window flashes a NO DISC message for 4 seconds.

## SEEK

Push ◀ SEEK to select the previous track number, or push SEEK ▶ to select the next track number. After the last track on a disc, pushing SEEK ▶ selects the first track of the same disc.

## TUNE DISCS

Push ◀ TUNE DISCS to select the previous CD in the magazine. Push TUNE DISCS ▶ to select the next CD in the magazine.

## SCAN

Push this button to audition the first 10 seconds of each track on a disc. At the end of the disc, the SCAN function continues with the first track on the same disc. The display window flashes the track number being auditioned during the SCAN function.

## REW

Press this button to reverse the CD mechanism and move back to a previous point on the disc. If held for less than three seconds, this button causes the CD to reverse at three times the normal play speed. If held for more than three seconds, the CD re-

verses at 10 times the normal play speed.

The mechanism reverses to the beginning of track 1 and begins play if the button is held continuously. The volume decreases and the display window shows the elapsed time during the entire fast reverse period.

## FF

Press this button to advance the CD mechanism and move ahead on the disc. If held for less than three seconds, this button causes the CD to advance at three times the normal play speed. If held for more than three seconds, the CD advances at 10 times the normal play speed.

The volume decreases and the display window shows the elapsed time during the entire fast forward period.

## COMP

Press this button to activate the compression function. This function reduces the dynamic range of the CD program material, which provides the listener with a more consistent level of volume. The display window shows a C or COMP (dual media radio) when the compression button is pushed.

## SHUFFLE

Press this button to randomly select the play order of the tracks on a CD. When all tracks of one CD have been played, the system changes to the next CD in the magazine and proceeds to play the tracks in a randomly selected order. The shuffle feature remains in effect until turned off by pressing the SHUFFLE button again.

When the shuffle function is activated, SHUFFLE illuminates in the display.

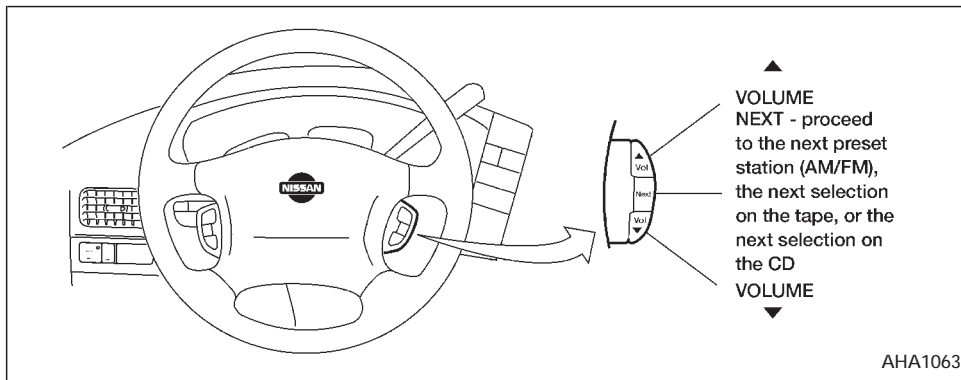

## STEERING WHEEL CONTROLS

The radio controls mounted on the right side of the steering wheel provide convenient access to three commonly used functions:

▲ VOL, ▼ VOL, and NEXT. Use the NEXT button to select the next pre-programmed station (AM/FM), the next selection on the tape, or the next selection on the CD.

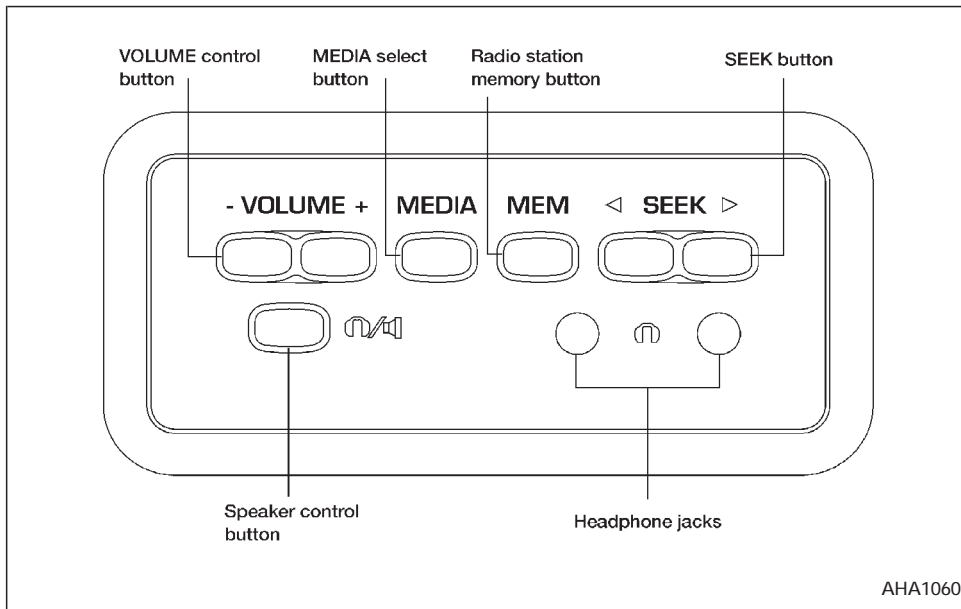

AHA1060

## REAR AUDIO CONTROLS

Radio features controlled by the rear seat remote control (if so equipped) are listed below:

- Volume: -/+

- Media select: AM/FM, tape, CD, or CD changer.
- Speakers ON/OFF
- Mem: proceed to the next preset station (AM/FM).

- Seek: ◀▶

Push the Memory three and Memory five buttons on the front radio controls simultaneously to turn the rear controls on. Push them again to turn the rear audio controls off.

The  (headphones symbol) illuminates in the front display when the rear audio controls are on. Two headphone jacks are provided so two rear seat passengers may listen to the audio system privately.

The rear volume controls can only increase the volume to the level at which the front radio volume control is set.

Headphones are not included with the vehicle. Most portable radio headphones work with the rear audio controls.

For vehicles equipped with the premium AM-FM radio with cassette player and compact disc player and 6 disc CD player, if the rear passengers turn off the rear speakers and are using headphones they may choose to listen to a different media than the front passengers. The rear passengers can listen to the radio while the front passengers can listen to the same thing, a cassette tape, CD, or the CD changer. The radio will go into DUAL PLAY mode and the rear

passengers can use the rear controls to change media.

### VOLUME button

The VOLUME button allows the rear passengers to adjust the headphone volume level.

### MEDIA button

The MEDIA button allows the rear passenger to change between AM, FM1, FM2, TAPE, CD, & CD DJ.

### MEM button

In AM, FM1, or FM2 mode the MEM button allows the rear passenger to successively access memory preset station 1 through 6.

In CD DJ mode the MEM button allows the rear passengers to select other compact discs in the CD changer.

### SEEK button

In AM, FM1, or FM2 mode the SEEK ◀ and ▶ button allows the rear passengers to find the next radio station up or down the station band frequency.

In TAPE mode the SEEK ◀ and ▶ button allows the rear passengers use Au-

tomatic Music Search (AMS) to find the next or previous song on the cassette.

In CD mode the SEEK ◀ and ▶ button allows the rear passengers to find the next or previous selection on the CD.

In CD DJ mode the SEEK ◀ and ▶ button allows the rear passengers to find the next or previous selection on the CD.

For vehicles equipped with the AM-FM radio with cassette player, when the rear seat controls are on, push the SPKRS ON-OFF button to turn all speakers off. Push again to turn all speakers on.

For vehicles equipped with the premium AM-FM radio with cassette player and compact disc player and 6 disc CD player, when the rear seat controls are on, push the SPKRS ON-OFF button to turn the rear speakers off. Push again to turn the rear speakers on.

If the rear audio system was on when the ignition was turned OFF, the audio system “remembers” and the rear system is still on when the engine is started again. The system also “remembers” if the speakers were ON or OFF. Therefore, the speakers may have to be turned on again by pressing the

## CB RADIO OR CAR PHONE

SPKRS ON-OFF button or turning the rear audio controls off.

### Microphone installed model

If equipped with a genuine NISSAN cellular phone, your NISSAN features a non-directional microphone in the steering column cover, so it is not necessary to look at or speak directly into the microphone when calling.

To do so could detract from the driving operation and cause an accident.

See the manual for car phone operation.

### Pre-wired and antenna for phone installed model

Some models are pre-wired to accept the genuine NISSAN cellular phone.

In addition, the same model has the phone antenna built into the rear glass window.

When installing a CB ham radio, a car phone or other transmitters in your NISSAN, be sure to observe the following cautions, otherwise the new equipment may adversely affect the MFI (Multiport Fuel Injection) system and other electronic parts.

Behind glove box

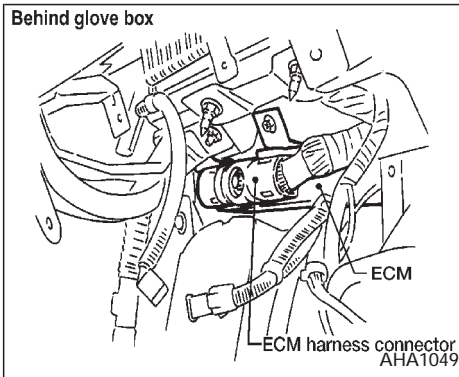

- Connect the ground wire from the CB radio chassis to the body.
- For details, consult an authorized NISSAN dealer.

**⚠ CAUTION**

- Keep the antenna as far away as possible from the electronic control unit (including the radio).
- Also keep the antenna wire more than 8 inches (20 cm) away from the Multiport Electronic Fuel Injection (MFI) harness. Do not route the antenna wire next to any harness.
- Adjust the antenna standing-wave ratio as recommended by the manufacturer.

**MEMO**

4-36 **Heater, air conditioner and audio systems**

# 5 Starting and driving

Precautions when starting and driving.....	5-2	Parking brake operation.....	5-9
Exhaust gas (carbon monoxide).....	5-2	Cruise control (if so equipped).....	5-9
Three way catalyst.....	5-2	Break-in schedule.....	5-11
Avoiding collision and rollover.....	5-3	Increasing fuel economy.....	5-12
Drinking alcohol/drugs and driving.....	5-3	Parking/parking on hills.....	5-13
Ignition switch.....	5-4	Power steering system.....	5-14
Before starting the engine.....	5-5	Brake system.....	5-14
Driving with an automatic transmission.....	5-5	Anti-lock brake system (ABS) (if so equipped)....	5-15
Overdrive switch.....	5-7	Cold weather driving.....	5-16
Starting the engine.....	5-8		





## PRECAUTIONS WHEN STARTING AND DRIVING

### WARNING

Do not leave children, unreliable adults, or pets alone in your vehicle. They could accidentally injure themselves or others through inadvertent operation of the vehicle. Also, on hot, sunny days, temperatures in a closed vehicle could quickly become high enough to cause severe or possibly fatal injuries to people or animals.

## EXHAUST GAS (Carbon Monoxide)

### WARNING

Do not breathe exhaust gases; they contain colorless and odorless carbon monoxide. Carbon monoxide is dangerous. It can cause unconsciousness or death.

- If you suspect that exhaust fumes are entering the vehicle, drive with all windows fully open, and have the vehicle inspected immediately.
- Do not run the engine in closed spaces such as a garage for any longer than is absolutely necessary.

- Do not park the vehicle with the engine running for any extended length of time.
- Keep the rear door and flip-up rear window closed while driving, otherwise exhaust gases could be drawn into the passenger compartment. If you must drive in this manner for some reason, take the following steps.

1. Open all the windows.

2. Set the air recirculate switch to off and the fan control dial at four (high) to circulate the air.

- If electrical wiring or other cable connections must pass to a trailer through a seal on the body, follow the manufacturer's recommendation to prevent carbon monoxide entry into the vehicle.
- The exhaust system and body should be inspected by a qualified mechanic whenever:
  - a. The vehicle is raised for service.

- b. You suspect that exhaust fumes are entering into the passenger compartment.
- c. You notice a change in the sound of the exhaust system.
- d. You have had an accident involving damage to the exhaust system, underbody, or rear of the vehicle.

## THREE WAY CATALYST

The three way catalyst is an emission control device installed in the exhaust system. Exhaust gases in the three way catalyst are burned at high temperatures to help reduce pollutants.

### WARNING

- The exhaust gas and the exhaust system are very hot. Keep people or flammable materials away from the exhaust pipe.
- Do not stop or park the vehicle over flammable materials such as dry grass, waste paper or rags. They may ignite and cause a fire.

 CAUTION

- Do not use leaded gasoline. Deposits from leaded gasoline will seriously reduce the three way catalyst's ability to help reduce exhaust pollutants.
- Keep your engine tuned up. Malfunctions in the ignition, fuel injection, or electrical systems can cause over-rich fuel flow into the catalyst, causing it to overheat. Do not keep driving if the engine misfires, or if noticeable loss of performance or other unusual operating conditions are detected. Have the vehicle inspected promptly by an authorized NISSAN dealer.
- Avoid driving with an extremely low fuel level. Running out of fuel could cause the engine to misfire, damaging the three way catalyst.
- Do not race the engine while warming it up.
- Do not push or tow your vehicle to start the engine.

## AVOIDING COLLISION AND ROLLOVER

 WARNING

Failure to operate this vehicle in a safe and prudent manner may result in loss of control or an accident.

Be alert and drive defensively at all times. Obey all traffic regulations. Avoid excessive speed, high speed cornering, or sudden steering maneuvers, because these driving practices could cause you to lose control of your vehicle. **As with any vehicle, loss of control could result in a collision with other vehicles or objects, or cause the vehicle to roll over, particularly if the vehicle slides sideways.** Be attentive at all times, and avoid driving when tired. Never drive when under the influence of alcohol or drugs (including prescription or over-the-counter drugs which may cause drowsiness). Always wear your seat belt as outlined in the "Seat belts" section of this manual, and also instruct your passengers to do so.

## DRINKING ALCOHOL/DRUGS AND DRIVING

 WARNING

Never drive under the influence of alcohol or drugs. Alcohol in the bloodstream reduces coordination, delays reaction time and impairs judgement. Driving after drinking alcohol increases the likelihood of being involved in an accident injuring yourself and others. **Additionally, if you are injured in an accident alcohol can increase the severity of the injury.**

NISSAN is committed to safe driving. However, you must choose not to drive under the influence of alcohol. Every year thousands of people are injured or killed in alcohol related accidents. Although the local laws vary on what is considered to be legally intoxicated, the fact is alcohol affects all people differently and most people underestimate the effects of alcohol.

Remember, drinking and driving don't mix!

And that's true for drugs, too (over the counter, prescription, and illegal drugs). Don't drive if your ability to operate your vehicle is impaired by alcohol, drugs, or some other physical condition.

## IGNITION SWITCH

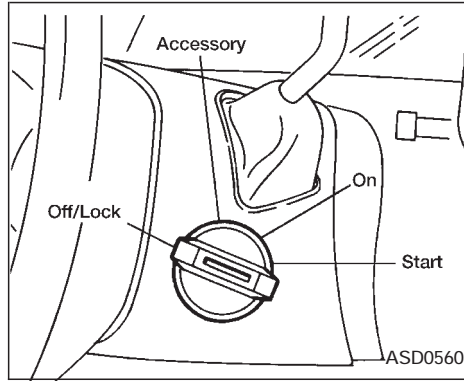

The ignition switch includes an anti-theft steering lock device. The key can only be removed when the ignition switch is in the LOCK position.

The ignition lock is designed so the key cannot be turned to LOCK and removed until the shift lever is moved to the P (Park) position.

The shift lever is designed so it cannot be moved out of P (Park) and into any of the other gear positions if the ignition key is turned to LOCK, or if the key is removed from the switch.

### 5-4 Starting and driving

**The shift lever can be moved out of P (Park) only after the ignition switch is in the ON position, and the foot brake pedal is depressed.**

**To lock the steering wheel, remove the key. To unlock the steering wheel, insert the key and turn it gently while rotating the steering wheel slightly right and left.**

#### WARNING

**Never remove the key while driving. If the key is removed, the steering wheel will lock. This may cause the driver to lose control of the vehicle and could result in serious vehicle damage or personal injury.**

### Key positions

LOCK (Normal parking position)

OFF

The engine can be turned off without locking the steering wheel, if the key is left in the ignition.

ACC (Accessories)

This position activates electrical accessories such as the radio when the engine is not running.

ON (Normal operating position)

This position turns on the ignition system and the electrical accessories.

START

This position activates the starter motor, which starts the engine.

## BEFORE STARTING THE ENGINE

- Make sure the area around the vehicle is clear.
- Maintenance items listed here should be checked periodically (for example, each time you check engine oil).
- Check that all windows and lights are clean.
- Visually inspect tires for their appearance and condition. Also check tires for proper inflation.
- Lock all doors.
- Position seat and adjust head restraints.
- Adjust inside and outside mirrors.
- Fasten seat belts and ask all passengers to do likewise.
- Check the operation of warning lights when key is turned to the ON position. See “Warning/Indicator lights and chimes” in the “Instrument and controls” section.

## DRIVING WITH AN AUTOMATIC TRANSMISSION

### WARNING

- **Do not depress the accelerator pedal while shifting from P (Park) or N (Neutral) to: R (Reverse), D (Drive), 2 or 1. Always depress the brake pedal until shifting is completed. Failure to do so could cause you to lose control and have an accident.**
- **Cold engine idle speed is high, so use caution when shifting into a forward or reverse gear before the engine has warmed up.**
- **Never shift to P (Park) or R (Reverse) while the vehicle is moving. This could cause an accident.**

### CAUTION

- **When stopping the vehicle on an uphill grade, do not hold the vehicle by depressing the accelerator pedal. The foot brakes should be used for this purpose.**
- **On slippery roads, do not downshift. This may cause a loss of control.**

The automatic transmission in your vehicle is electronically controlled by a transmission control module to produce maximum power and smooth operation.

Shown on the following pages are the recommended operating procedures for this transmission. Follow these procedures for maximum vehicle performance and driving enjoyment.

### Starting the vehicle

- After starting the engine, fully depress the foot brake pedal before shifting the selector lever to the R (Reverse), N (Neutral), D (Drive), 2 or 1 position. Be sure the vehicle is at a complete stop before attempting to shift the selector lever.

**This automatic transmission is designed so the foot brake pedal MUST be depressed before shifting from P (Park) to any other position while the ignition switch is ON.**

The selector lever cannot be moved out of P (Park) and into any of the other gear positions if the ignition key is turned to ACC, LOCK, or if the key is removed from the switch.

**The shift lever can be moved if the ignition switch is in the ACC position. This allows the vehicle to be moved if the battery is discharged.**

1. Keep the foot brake pedal depressed and shift into a driving gear.
2. Release the parking brake and foot brake, then gradually start the vehicle in motion.

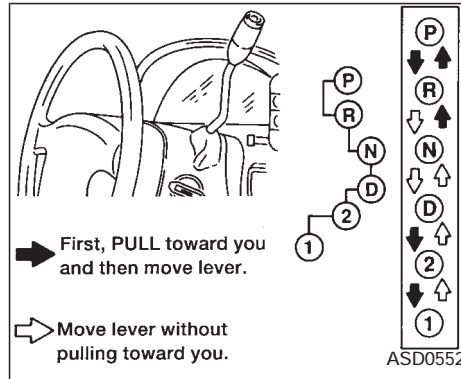

### Shifting with automatic transmission

#### P (Park):

Use this selector position when the vehicle is parked or when starting the engine. Always be sure the vehicle is at a complete stop. For maximum safety, depress the brake pedal, pull the lever toward you, and move the lever to the P (Park) position. Apply the parking brake. When parking on a hill, apply the parking brake first, then shift the lever into the P (Park) position.

### Shifting from P (Park)

If the ignition switch is in the ON position and the foot brake pedal is depressed, but the shift lever still cannot be moved out of P (Park), follow these instructions:

1. Shut the engine off and remove the key.
2. Apply the parking brake.
3. Reinsert the ignition key and turn it clockwise to the first position (ACC).
4. Depress the brake pedal, move the gear-shift lever to N (Neutral).
5. Start the engine.

#### R (Reverse):

Use this position to back up. Always be sure the vehicle is completely stopped. Depress the brake pedal, then pull the shift lever toward you and move it to the R (Reverse) position.

### N (Neutral):

Neither forward nor reverse gear is engaged. The engine can be started in this position. You may shift to N (Neutral) and restart a stalled engine while the vehicle is moving.

### D (Drive):

Use this position for all normal forward driving.

### 2 (Second gear):

Use for hill climbing or engine braking on downhill grades.

Do not downshift into 2 at speeds above 63 MPH (100 km/h). Do not exceed 63 MPH (100 km/h) in 2.

### 1 (Low gear):

Use 1 when climbing steep hills slowly or driving slowly through deep snow, sand or mud, or for maximum engine braking on steep downhill grades.

Do not exceed 38 MPH (60 km/h) in 1.

Do not shift into 1 at speeds above 38 MPH (60 km/h).

### Accelerator downshift In D position

For rapid passing or hill climbing, fully depress the accelerator pedal to the floor. This shifts the transmission down into third gear, second gear or first gear, depending on the vehicle speed.

### Fail-safe

When the Fail-safe operation occurs, the next time the key is turned to the ON position, the O/D OFF light blinks for approximately 8 seconds after coming on for 2 seconds. While the vehicle can be driven under these circumstances, please note that the gears in the automatic transmission will be locked in 3rd gear.

**NOTE:** If the vehicle is driven under extreme conditions, such as excessive wheel spinning and subsequent hard braking, the Fail-safe system may be activated. This will occur even if all electrical circuits are functioning properly. In this case, turn the ignition key OFF and wait for 3 seconds. Then turn the key back to the ON position. The vehicle should return to its normal operating condition. If it does not return to its normal operating condition, have an authorized NISSAN dealer check the transmission and repair, if necessary.

## OVERDRIVE SWITCH

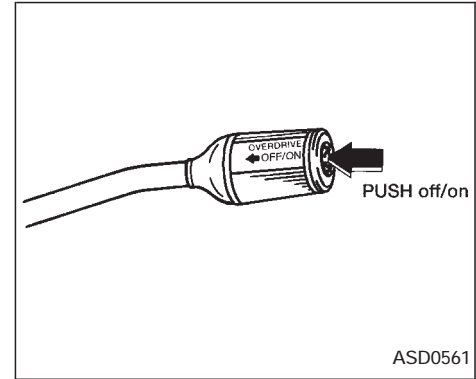

Each time your vehicle is started, the transmission is automatically “reset” to overdrive ON.

**ON:** For normal driving the overdrive switch is engaged. The transmission is upshifted into overdrive as the vehicle speed increases.

**The overdrive does not engage until the engine has reached operating temperature.**

**OFF:** For driving up and down long slopes where engine “braking” is necessary, push the overdrive switch

## STARTING THE ENGINE

once. The O/D OFF indicator light illuminates at this time. When cruising at a low speed or climbing a gentle slope, you may feel uncomfortable shift shocks as the transmission shifts between 3rd gear and overdrive repeatedly. In this case, press the overdrive switch.

When driving conditions change, press the overdrive switch to turn the overdrive on. The O/D OFF indicator light goes out.

Remember not to drive at high speeds for extended periods of time with the O/D OFF light illuminated. This reduces the fuel economy.

1. Apply the parking brake.
2. Move the selector lever to P (Park) or N (Neutral) (P is recommended).

**The shift selector lever cannot be moved out of P and into any of the other gear positions under the following conditions:**

- The ignition key is turned to the OFF position.
- The ignition key is turned to the ON position without depressing the foot brake pedal.

**The starter will not operate if the shift selector lever is in one of the driving positions.**

3. Crank the engine **with your foot off the accelerator pedal** by turning the ignition key to START. Release the key when the engine starts. If the engine starts, but fails to run, repeat the above procedure.

**— If the engine is very hard to start in extremely cold or hot weather, depress the accelerator pedal to the floor and hold it to help start the engine.**

**— In the summer, when restarting the engine within 30 minutes after it has been stopped, keep the accelerator pedal slightly depressed while starting.**



### CAUTION

**Do not operate the starter for more than 15 seconds at a time. If the engine does not start, turn the key off and wait 10 seconds before cranking again, otherwise the starter could be damaged.**

4. Warm-up

Allow the engine to idle for at least 30 seconds after starting. Drive at moderate speeds for a short distance first, especially in cold weather.

## PARKING BRAKE OPERATION

### WARNING

- Be sure the parking brake is fully released before driving. Failure to do so can cause brake failure and lead to an accident.
- Do not release the parking brake from outside the vehicle.
- Do not use the gearshift in place of the parking brake. When parking, be sure the parking brake is fully engaged.
- Do not leave children unattended in a vehicle. They could release the parking brake and cause an accident.

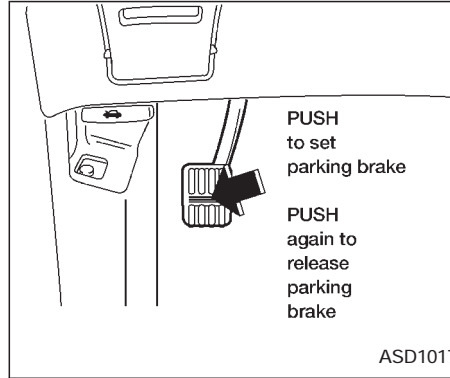

**To apply:** Firmly depress the parking brake.

#### **To release:**

1. Firmly apply the foot brake.
2. Move the shift selector lever to the P (Park) position.
3. Press and release the parking brake pedal completely.
4. Before driving, be sure the brake warning light goes out.

## CRUISE CONTROL (if so equipped)

### WARNING

Do not use the cruise control when driving under the following conditions:

- it is not possible to keep the vehicle at a set speed.
- in heavy traffic or in traffic that varies in speed.
- on winding or hilly roads.
- on slippery roads (rain, snow, ice, etc.).
- in very windy areas.

Doing so could cause a loss of vehicle control and result in an accident.



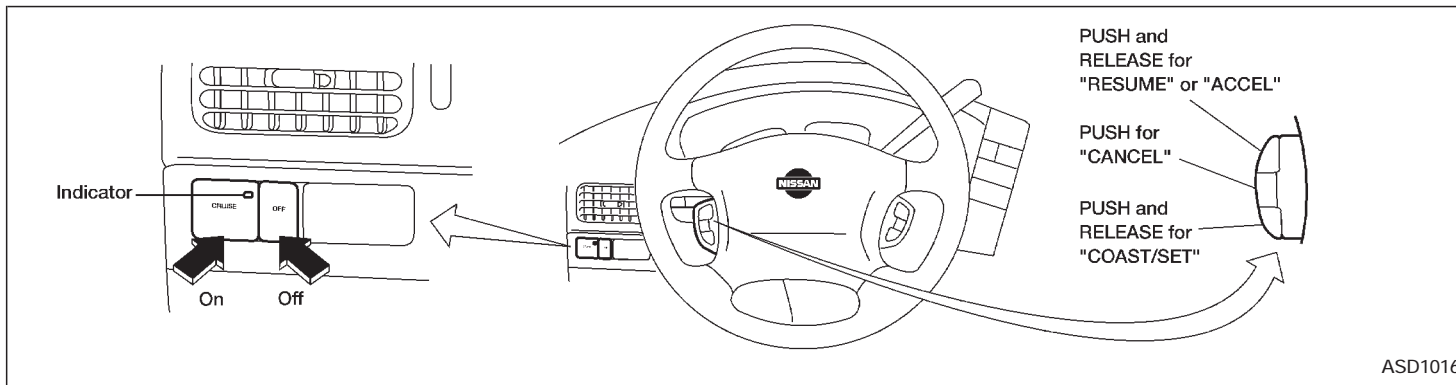

The cruise control allows driving at speeds between 30 and 90 MPH (48 and 144 km/h) without keeping your foot on the accelerator pedal.

**To turn the cruise control on**, push the CRUISE CONT main switch. The indicator light on the switch comes on.

**To set at cruising speed**, accelerate your vehicle to the desired speed, push the COAST/SET switch and release it. The CRUISE light in the instrument cluster comes on. Take your foot off the accelerator pedal. Your vehicle maintains the set speed.

## 5-10 Starting and driving

- **To pass another vehicle**, depress the accelerator pedal. When you release the pedal, the vehicle returns to the previously set speed.
- The vehicle may not maintain the set speed when going up or down steep hills. If this happens, drive without the cruise control.

**To cancel the preset speed**, follow any of these three methods.

- Push the CANCEL button; the CRUISE light in the instrument panel goes out.

- Tap the brake pedal; the CRUISE light goes out.
  - Push the cruise control OFF switch. Both the ON indicator and CRUISE lights go out.
- If you depress the brake pedal while pushing the RES/ACCEL switch, the RES/ ACCEL function is cancelled.

In order for the RES/ACCEL switch to operate, the COAST/SET must be used to re-engage the system.

- The cruise control automatically cancels if the vehicle slows down more than 5 MPH (8 km/h) below the set speed.

## BREAK-IN SCHEDULE

- Move the selector lever to N (Neutral). The CRUISE light goes out.

**To reset at a faster cruising speed**, use one of the following three methods:

- a) Depress the accelerator pedal. When the vehicle attains the desired speed, push and release the COAST/SET switch.
- b) Push and hold the RES/ACCEL switch. When the vehicle attains the speed you desire, release the switch.
- c) Push and release the RES/ACCEL switch. Each time you do this, the set speed increases by about 1 MPH (1.6 km/h).

**To reset at a slower cruising speed**, use one of the following three methods.

- a) Lightly tap the brake pedal. When the vehicle attains the desired speed, push the COAST/SET switch and release it.
- b) Push and hold the COAST/SET switch. Release the switch when the vehicle slows down to the desired speed.
- c) Push and release the COAST/SET switch. Each time you do this, the set

speed decreases by about 1 MPH (1.6 km/h).

**To resume the preset speed**, push and release the RES/ACCEL switch. The vehicle resumes the last set cruising speed when the vehicle speed is over 30 MPH (48 km/h).

### Precautions

- If the cruise control system malfunctions, it cancels automatically. The CRUISE light in the instrument panel then blinks to warn the driver.
- When the CRUISE light blinks, turn the CRUISE CONT main switch OFF and have the system checked by an authorized NISSAN dealer.
- The CRUISE light in the instrument panel may blink when the CRUISE CONT main switch is turned ON while pushing either the RES/ACCEL, COAST/SET, or the CANCEL switch (located on the steering wheel). To properly set the cruise control system, perform the steps in the order indicated.

During the first 1,000 miles (1,600 km), follow these recommendations for the future reliability and fuel economy of your new vehicle. Failure to follow these recommendations may result in vehicle damage or shortened engine life.

- Do not drive over 55 MPH (90 km/h) and do not run the engine over 4,000 RPM. Avoid driving for long periods at constant speed, either fast or slow.
- Do not accelerate at full throttle in any gear.
- Avoid quick starts.
- Avoid hard braking as much as possible.
- Do not tow a trailer for the first 500 miles (800 km).

## INCREASING FUEL ECONOMY

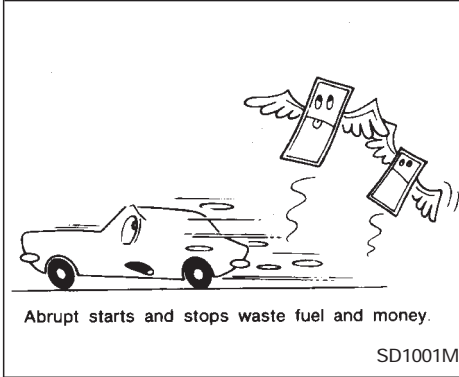

- Accelerate slowly and smoothly. Maintain cruising speeds with a constant accelerator position.
- Drive at moderate speeds on the highway. Driving at high speed lowers fuel economy.
- Avoid unnecessary stopping and braking. Maintain a safe distance behind other vehicles.
- Use a proper gear range which suits road conditions. On level roads, shift into high gear as soon as possible.
- Avoid unnecessary engine idling.

### 5-12 Starting and driving

- Keep your engine tuned up.
- Follow the recommended periodic maintenance schedule.
- Keep the tires inflated at the correct pressure. Low tire pressure increases tire wear and wastes fuel.
- Keep the wheels in correct alignment. Improper alignment causes not only tire wear but also lower fuel economy.
- Air conditioner operation lowers fuel economy. Use the air conditioner only when necessary.
- When cruising at highway speeds, it is more economical to use the air conditioner and leave the windows closed to reduce drag.

## PARKING/PARKING ON HILLS

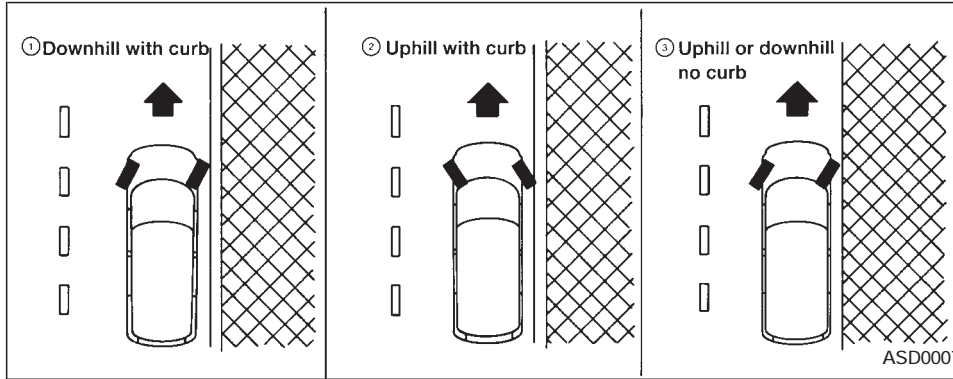

### **⚠ WARNING**

Do not park the vehicle over flammable materials such as dry grass, waste paper or rags. They may ignite and cause a fire.

1. Firmly apply the parking brake.
2. Move the selector lever to the P (Park) position.

### **⚠ WARNING**

- Safe parking procedures require that both the parking brake be set and the transmission placed into P (Park) position. Failure to do so could cause the vehicle to move unexpectedly or roll away and result in an accident. Make sure the shift lever has been pushed up as far as it can go and cannot be moved without pulling it towards you.
- Never leave the engine running while the vehicle is unattended.

- Do not leave children unattended inside the vehicle. They could unknowingly activate switches or controls. Unattended children could become involved in serious accidents.

3. To help prevent the vehicle from rolling into the street when parked on a sloping driveway, it is a good practice to turn the wheels as illustrated.
- HEADED DOWNHILL WITH CURB: ①  
Turn the wheels toward the curb and move the vehicle forward until the curb side wheel gently touches the curb.
  - HEADED UPHILL WITH CURB: ②  
Turn the wheels away from the curb and move the vehicle back until the curb side wheel gently touches the curb.
  - HEADED UPHILL OR DOWNHILL, NO CURB: ③  
Turn the wheels toward the side of the road so the vehicle will move away from the center of the road if it moves.
4. Turn the ignition key to the LOCK position and remove the key.

## POWER STEERING SYSTEM

The power assisted steering is designed to use a hydraulic pump, driven by the engine, to aid steering.

If the engine stops or the drive belt breaks, you still have control of the vehicle. However, much greater steering effort is needed, especially in sharp turns and at low speeds.

### WARNING

**If the engine is not running or is turned off while driving, the power assist for the steering will not work. Steering will be much harder to operate.**

## BRAKE SYSTEM

The brake system has two separate hydraulic circuits. If one circuit develops a problem you will still have braking at two wheels.

### Vacuum assisted brake

The brake booster aids braking by using engine vacuum. If the engine stops, you can stop the vehicle by depressing the brake pedal. However, greater foot pressure on the brake pedal is required to stop the vehicle, and stopping distance is longer.

### Wet brakes

When the vehicle is washed or driven through water, the brakes may get wet. As a result, your braking distance is longer and the vehicle may pull to one side during braking.

To dry the brakes, drive the vehicle at a safe speed while lightly pressing the brake pedal to heat up the brakes. Do this until the brakes return to normal. Avoid driving the vehicle at high speeds until the brakes function correctly.

### Using the brakes

Avoid resting your foot on the brake pedal while driving. This overheats the brakes, wears out the brake linings and pads faster

and reduces fuel economy.

To help save the brakes and to prevent the brakes from overheating, reduce speed and downshift to a lower gear before going down a slope or long grade. Overheated brakes may reduce braking performance and could result in loss of vehicle control.

### WARNING

- **While driving on a slippery surface, be careful when braking, accelerating or downshifting. Abrupt braking actions or sudden acceleration could cause the wheels to skid and result in an accident.**
- **If the engine is not running or is turned off while driving, the power assist for the brakes will not work. Braking will be harder.**

## ANTI-LOCK BRAKE SYSTEM (ABS) (if so equipped)

The anti-lock brake system controls the brakes at each wheel so the wheels do not lock when braking abruptly or when braking on slippery surfaces. The system detects the rotation speed at each wheel and varies the brake fluid pressure to prevent each wheel from locking and sliding. By preventing wheel lockup, the system helps the driver maintain steering control and helps to minimize swerving and spinning on slippery surfaces.

### Using the system

Depress the brake pedal and hold it down.

#### WARNING

**Do not pump the brake pedal. Doing so may result in increased stopping distances.**

### Normal operation

The anti-lock brake system does not operate at speeds below 3 to 6 MPH (5 to 10 km/h). (The speeds vary according to road conditions.) When the anti-lock system senses one or more wheels are close to locking up, the actuator (under the hood) rapidly applies and releases hydraulic pressure (like pumping the brakes very quickly). While the actuator is

working, you may feel a pulsation in the brake pedal and hear a noise or vibration from the actuator under the hood. This is normal and indicates the anti-lock system is working properly. However, the pulsation may indicate road conditions are hazardous and extra care is required while driving.

### Self-test feature

The anti-lock brake system consists of electronic sensors, electric pumps, and hydraulic solenoids controlled by a computer.

**The computer has a built-in diagnostic feature that tests the system each time you start the engine and move the vehicle at a low speed in forward or reverse.**

When the self-test occurs, you may hear a “clunk” noise and/or feel a pulsation in the brake pedal. This is normal and is not an indication of any malfunction. If the computer senses any malfunction, it switches the anti-lock brake system OFF and turns on the ABS brake warning light in the dashboard. The brake system then operates normally, but without anti-lock assistance.

If the light comes on during the self-test, or while driving, take the vehicle to an authorized NISSAN dealer for repair.

#### WARNING

**The anti-lock brake system is a sophisticated device, but it cannot prevent accidents resulting from careless or dangerous driving techniques. It can help maintain vehicle control during braking on slippery surfaces, but remember that the stopping distance on slippery surfaces will be longer than on normal surfaces, even with the anti-lock system. Stopping distances may also be longer on rough, gravel or snow covered roads, or if you are using tire chains. Always maintain a safe distance from the vehicle in front of you. Ultimately, the responsibility for safety of self and others rests in the hands of the driver.**

**Tire type and condition of tires may also affect braking effectiveness.**

- **When replacing tires, install the specified size of tires on all four wheels.**

## COLD WEATHER DRIVING

- When installing a spare tire, make sure it is the proper size and type as specified on the tire placard. For tire placard location information, refer to “Tire placard” in the Owner’s Manual index.
- Refer to “Wheels and tires” in the “Do-it-yourself” section of this manual.

### Freeing a frozen door lock

To prevent a door lock from freezing, apply de-icer or glycerin through the key hole. If the lock becomes frozen, heat the key before inserting it in the key hole.

### Anti-freeze

In the winter, when it is anticipated that the temperature will drop below 32°F (0°C), check the anti-freeze (ethylene glycol base) to assure proper winter protection. For details, see “Engine cooling system” in the “Do-it-yourself” section of this manual.

### Battery

If the battery is not fully charged during extremely cold weather conditions, the battery fluid may freeze and damage the battery. To maintain maximum efficiency, the battery should be checked regularly. For details, see “Battery” in the “Do-it-yourself” section of this manual.

### Draining of coolant water

If the vehicle is to be left outside without anti-freeze, drain the cooling system by opening the drain valves located under the radiator and on the engine block. Refill

before operating the vehicle. See “Changing engine coolant” in the “Do-it-yourself” section of this manual.

### Tire equipment

1. SUMMER tires are of a tread design to provide superior performance on dry pavement. However, the performance of these tires is substantially reduced in snowy and icy conditions. If you operate your vehicle on snowy or icy roads, NISSAN recommends using MUD & SNOW or ALL SEASON tires on all four wheels. Please consult your NISSAN dealer for the tire type, size, speed rating and availability information.
2. For additional traction on icy roads, studded tires may be used. However, some Canadian provinces and U.S. states prohibit their use. Check local, state and provincial laws before installing studded tires.

**Skid and traction capabilities of studded snow tires, on wet or dry surfaces, may be poorer than that of non-studded snow tires.**

3. Tire chains may be used. Make sure they are of proper size for the tires on your vehicle and are installed according to the

chain manufacturer's suggestions. In addition, drive at a reduced speed, otherwise, your vehicle may be damaged and/or vehicle handling and performance may be adversely affected.

## Tire chains

Use of tire chains may be prohibited according to location. Check the local laws before installing tire chains. When installing tire chains, make sure they are of proper size for the tires on your vehicle and are installed according to the chain manufacturer's suggestions. **Use only SAE Class "S" chains.** Other types may damage your vehicle. Use chain tensioners when recommended by the tire chain manufacturer to ensure a tight fit. Loose end links of the tire chain must be secured or removed to prevent the possibility of whipping action damage to the fenders or undercarriage. If possible, avoid fully loading your vehicle when using tire chains. In addition, drive at a reduced speed. Do not exceed the maximum speed suggested by chain manufacturer. Otherwise, your vehicle may be damaged and/or vehicle handling and performance may be adversely affected.

Never install tire chains on T-type and small size spare tires. Do not use tire chains on dry roads.

## Special winter equipment

It is recommended that the following items be carried in the vehicle during winter:

1. A scraper and stiff-bristled brush to remove ice and snow from the windows and wiper blades.
2. A sturdy, flat board to be placed under the jack to give it firm support.
3. A shovel to dig the vehicle out of snow-drifts.
4. Extra window washer fluid to refill the reservoir tank.

## Driving on snow or ice

### WARNING

- **Wet ice (32°F, 0°C and freezing rain), very cold snow or ice can be slick and very hard to drive on. The vehicle will have a lot less traction or "grip" under these conditions. Try to avoid driving on wet ice until the road is salted or sanded.**

- **Whatever the condition, drive with caution. Accelerate and slow down with care. If accelerating or downshifting too fast, the drive wheels will lose even more traction.**
- **Allow more stopping distance under these conditions. Braking should be started sooner than on dry pavement.**
- **Allow greater following distances on slippery roads.**
- **Watch for slippery spots (glare ice). These may appear on an otherwise clear road in shaded areas. If a patch of ice is seen ahead, brake before reaching it. Try not to brake while actually on the ice, and avoid any sudden steering maneuvers.**
- **Do not use the cruise control on slippery roads.**
- **Snow can trap dangerous exhaust gases under your vehicle. Keep snow clear of the exhaust pipe and from around your vehicle.**



## Engine block heater (if so equipped)

An engine block heater to assist extreme cold temperature starting is available through an authorized NISSAN dealer.



### **WARNING**

**Do not use your heater with an ungrounded electrical system or two-pronged (cheater) adapters. You can be injured by an electrical shock if you use an ungrounded connection.**

# 6 In case of emergency

Flat tire .....	6-2
Jump starting.....	6-8
Push starting .....	6-10
If your vehicle overheats.....	6-10

After an accident .....	6-11
Tow truck towing .....	6-12
Vehicle recovery (freeing a stuck vehicle) .....	6-14



# FLAT TIRE

If you have a flat tire, follow the instructions below:

## Stopping the vehicle

1. Safely move the vehicle off the road and away from traffic.
2. Turn on the hazard warning flashers.
3. Park on a level surface and apply the parking brake. Move the gearshift lever to the P (Park) position.
4. Turn off the engine.
5. Raise the hood to warn other traffic, and to signal professional road assistance personnel that you need assistance.
6. Have all passengers get out of the vehicle and stand in a safe place, away from traffic and clear of the vehicle.

### WARNING

- **Make sure the parking brake is securely applied and the automatic transmission is shifted into P (Park).**
- **Never change tires when the vehicle is on a slope, ice or slippery areas. This is hazardous.**
- **Never change tires if oncoming traffic is close to your vehicle. Wait for professional road assistance.**

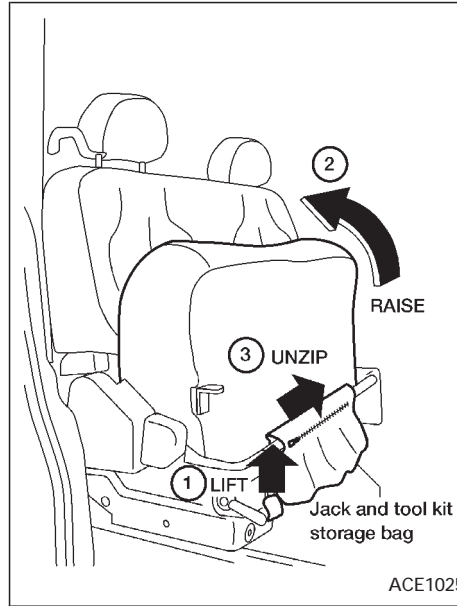

## Getting the tools and spare tire

Remove the jack jack storage bag located under the third row seat.

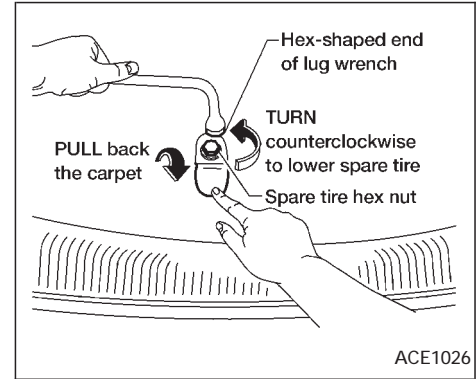

1. Locate the cut in the carpet for the hex nut in the the cargo area. The hex nut is used to lower and raise the spare tire located underneath the vehicle.
2. Place the lug wrench over the hex nut and turn counterclockwise until the cable extends completely. The spare tire hex nut rachets when the cable is fully extended.

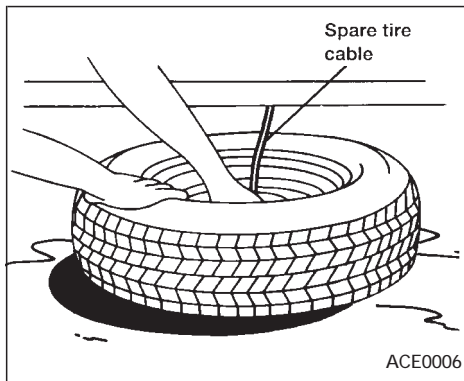

3. Carefully slide the tire from under the rear of the vehicle.

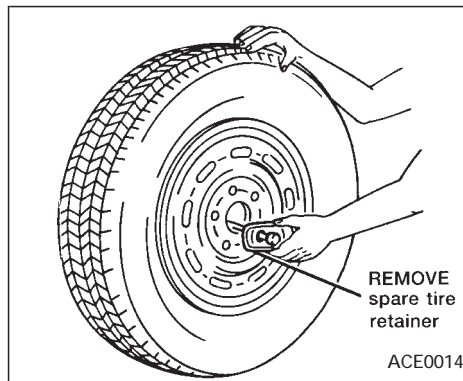

4. Stand the tire up to easily remove the retainer.

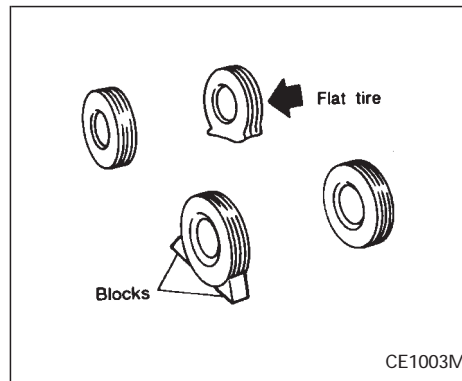

### Blocking wheels

Place suitable blocks at both the front and back of the wheel diagonally opposite the flat tire. This prevents the vehicle from rolling when it is jacked up.

#### **WARNING**

Be sure to block the wheel as the vehicle may move and result in personal injury.

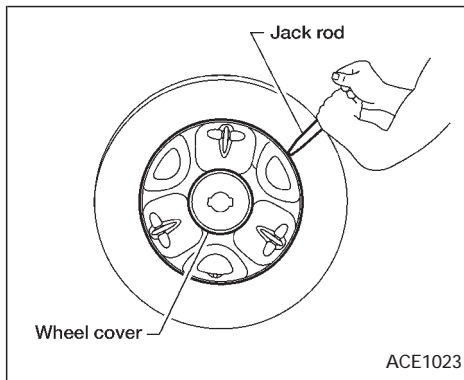

### Removing wheel cover

Remove the jack rod from the jack storage bag. For wheel cover removal, place the screwdriver tip of the jack rod between the wheel cover and the edge of the rim. Push and twist gently.

#### CAUTION

**Do not use your hands to pry off wheel caps or wheel covers. Doing so could result in personal injury.**

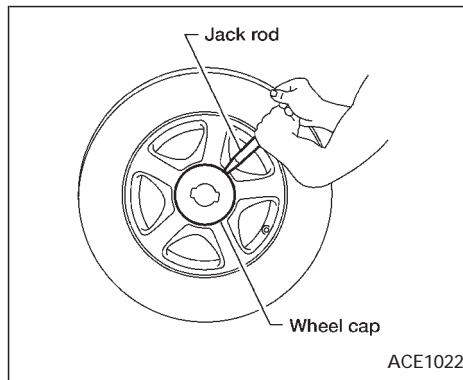

### Removing wheel cap

For cap removal, place the screwdriver tip of the jack rod into the indentation between the cap and the wheel. Push and twist gently.

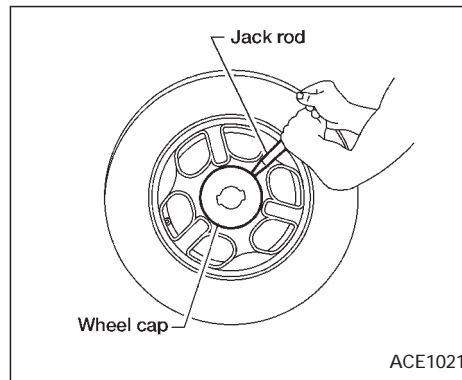

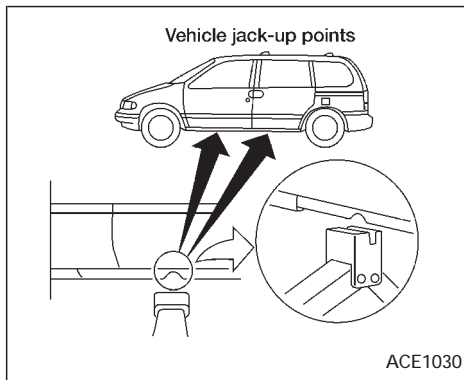

## Jacking up vehicle and removing tire

Carefully read the caution label attached to the jack body and the following instructions.

1. Loosen each wheel nut one or two turns by turning counterclockwise with the lug wrench. **Do not remove the wheel nuts until the tire is off the ground.**
2. Place the jack directly under the jack-up point as illustrated above so the top of the jack contacts the vehicle at the jack-up point. Align the center of both

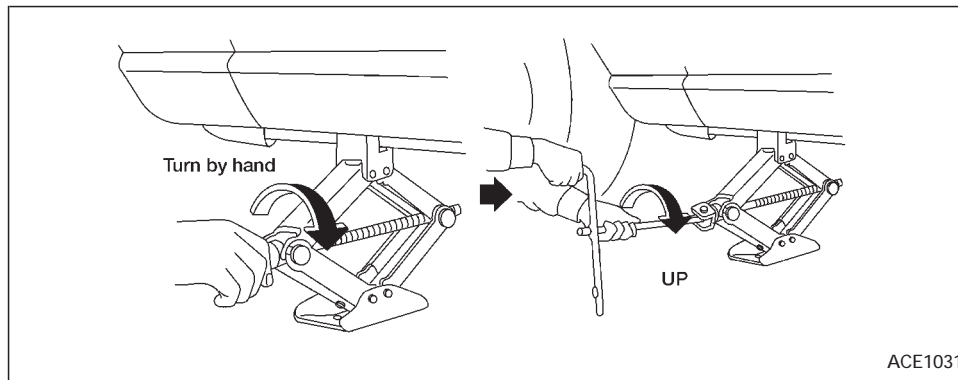

the jack head and the notch at the jack-up point as shown. Also fit the notched portion of the vehicle in the groove of the jack head as shown.

**The jack should be used on level, firm ground.**

3. Carefully raise the vehicle until the tire clears the ground. To lift the vehicle, securely hold the jack lever and rod with both hands as shown above. Remove the wheel nuts, and then remove the tire.

### **⚠ WARNING**

- **Never get under the vehicle while it is supported only by the jack.**
- **Use the jack provided with your vehicle. Do not use the jack provided with your vehicle on other vehicles. The jack is designed only for lifting your vehicle during a tire change.**
- **Use the correct jack-up points; never use any other part of the vehicle for jack support.**

- Never jack up the vehicle more than necessary.
- Never use blocks on or under the jack.
- Do not start or run engine while vehicle is on the jack as it may cause the vehicle to move.
- Do not allow passengers to stay in the vehicle while it is on the jack.
- Never run the engine with the wheels off of the ground. It may cause the vehicle to move.

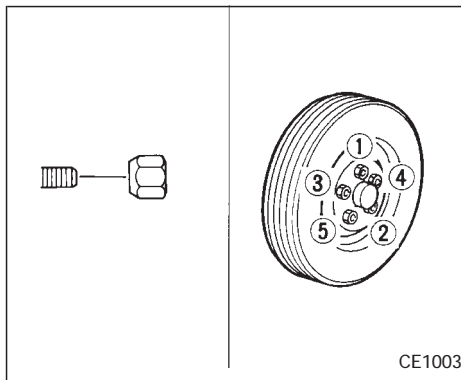

### Installing wheel

The T-type spare tire is designed for emergency use. See specific instructions under the heading “Wheels and tires” in the “Do-it-yourself” section of this manual.

1. Clean any mud or dirt from the surface between the wheel and hub.
2. Carefully put the wheel on and tighten the lug nuts finger tight.
3. With the lug wrench, tighten the lug nuts alternately and evenly until they are tight.

4. Lower the vehicle slowly until the tire touches the ground. Then, with the lug wrench, tighten the lug nuts securely in the sequence as illustrated. Lower the vehicle completely.

### **⚠ WARNING**

- Incorrect wheel nuts or improperly tightened wheel nuts can cause the wheel to become loose or come off. This could cause an accident.
- Do not use oil or grease on the wheel studs or nuts. This could cause the nuts to become loose.

As soon as possible, tighten the lug nuts to the specified torque with a torque wrench.

Lug nut tightening torque:  
72 to 87 ft-lb (98 to 118 N·m)

Adjust tire pressure to the **COLD** pressure.

**COLD** pressure:

After the vehicle has been parked for three hours or more or driven less than 1 mile (1.6 km).

**COLD** tire pressures are shown on the tire placard affixed to the inside of the glove box.

Retighten the lug nuts when the vehicle has been run for 600 miles (1,000 km) after installing the aluminum wheel.

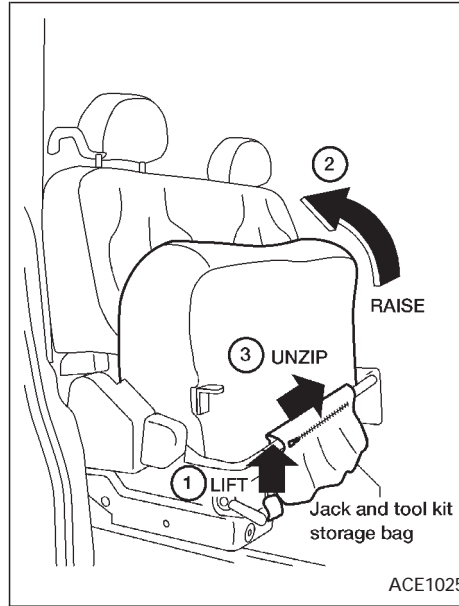

5. Securely store the jacking equipment in the vehicle.

### Stowing the spare tire or flat tire

1. To raise the tire to the stowed position, install the retainer through the wheel

center and turn the wheel lug wrench clockwise until the tire is raised to its original position underneath the vehicle.

**The spare tire hex nut ratchets when the tire is raised. It won't allow you to over-tighten.**

2. Check for proper seating against underbody supports. If necessary, loosen tire, reposition and retighten.

### **⚠ WARNING**

- Always make sure that the spare tire and jacking equipment are properly secured after use. Such items can become dangerous projectiles in an accident or sudden stop.
- The T-type spare tire is designed for emergency use. See specific instructions under the heading “Wheels and tires” in the “Do-it-yourself” section of this manual.



## JUMP STARTING

To start your engine with a booster battery, the instructions and precautions below must be followed.

### WARNING

- If done incorrectly, jump starting can lead to a battery explosion, resulting in severe injury or death. It could also damage your vehicle.
  - Explosive hydrogen gas is always present in the vicinity of the battery. Keep all sparks and flames away from the battery.
  - Do not allow battery fluid to come into contact with eyes, skin, cloth or painted surfaces. Battery fluid is a corrosive sulfuric acid solution which can cause severe burns. If the fluid should come into contact with anything, immediately flush the contacted area with water.
  - Keep battery out of the reach of children.
  - The booster battery must be rated at 12 volts. Use of an improper rated battery can damage your vehicle.
- Whenever working on or near a battery, always wear suitable eye protectors (for example, goggles or industrial safety spectacles) and remove rings, metal bands, or any other jewelry. Do not lean over when jump starting.
  - Do not attempt to jump start a frozen battery. It could explode and cause serious injury.
  - Your vehicle has an automatic engine cooling fan. It could come on at any time. Keep hands and other objects away from it.

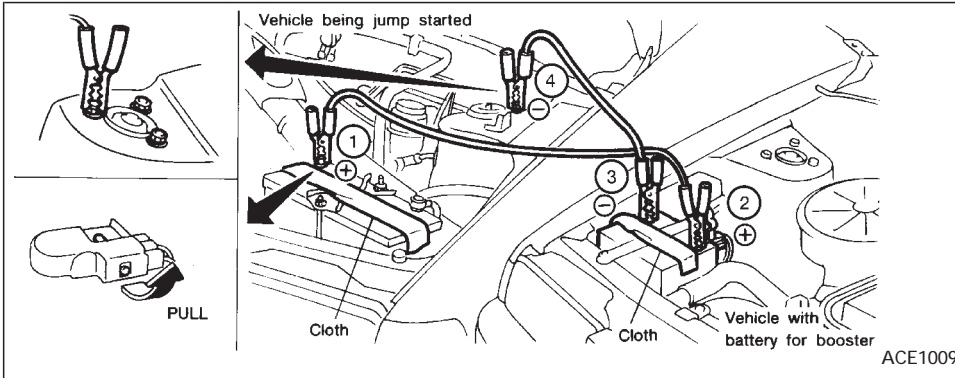

**Always follow the instructions below. Failure to do so could result in damage to the charging system and cause personal injury.**

1. If the booster battery is in another vehicle, position the two vehicles to bring their batteries close to each other.

**Do not allow the two vehicles to touch.**

2. Apply the parking brake. Move the gear-shift lever to the P (Park) position. Switch off all unnecessary electrical systems (lights, heater, air conditioner, etc.).

3. Remove vent caps on the battery (if so equipped). Cover the battery with an old cloth to reduce explosion hazard.

4. Connect jumper cables in the sequence as illustrated.

**⚠ CAUTION**

- **Always connect positive (+) to positive (+) and negative (-) to body ground (for example, the strut mounting bolt, etc. — not to the battery).**

- **Make sure that cables do not touch moving parts in the engine compartment and that clamps do not contact any other metal.**

5. Start the engine of the other vehicle and let it run for a few minutes.
6. Keep the engine speed of the other vehicle at about 2,000 RPM, and start the engine of the vehicle being jump started.

**⚠ CAUTION**

**Do not keep the starter motor engaged for more than 10 seconds. If the engine does not start right away, turn the key off and wait 3 to 4 seconds before trying again.**

7. After starting your engine, carefully disconnect the negative cable and then the positive cable.
8. Replace the vent caps (if so equipped). Be sure to dispose of the cloth used to cover the vent holes as it may be contaminated with corrosive acid.

## PUSH STARTING

### CAUTION

**Automatic transmission models cannot be push or tow started. This may cause transmission or other vehicle damage.**

## IF YOUR VEHICLE OVERHEATS

If your vehicle is overheating (indicated by an extremely high temperature gauge reading), or if you feel a lack of engine power, detect abnormal noise, etc., take the following steps:

### WARNING

- **Do not continue to drive if your vehicle overheats. Doing so could cause a vehicle fire.**
- **To avoid the danger of being scalded, never remove the radiator cap while the engine is still hot. When the radiator cap is removed, pressurized hot water will spurt out, possibly causing serious injury.**
- **Do not open the hood if steam is coming out.**

1. Move the vehicle safely off the road, apply the parking brake and move the gearshift lever to the P (Park) position.

**Do not stop the engine.**

2. Turn off the air conditioner switch. Open all the windows, move the temperature control dial to warm and fan control knob to four.

3. If engine overheating is caused by climbing a long hill on a hot day, run the engine at a fast idle (approximately 1,500 RPM) until the temperature gauge indication returns to normal.
4. Get out of the vehicle. Look and listen for steam or coolant escaping from the radiator before opening the hood. Wait until no steam or coolant can be seen before proceeding.
5. Open the hood.

### WARNING

**If steam or water is coming from the engine, stand clear to prevent getting burned.**

6. Visually check if the cooling fan is running. The radiator hoses and radiator should not leak water. If coolant is leaking or the cooling fan does not run, stop the engine.

## AFTER AN ACCIDENT

### WARNING

- Be careful not to allow your hands, hair or clothing to come into contact with, or to get caught in, the running fan, belts, or motor fan.
- The fan motor may start at any time when the coolant temperature is high.

7. After the engine cools down completely, check the coolant level in the reservoir tank with the engine running. Add coolant to the reservoir tank, if necessary. Have your vehicle repaired at an authorized NISSAN dealer.

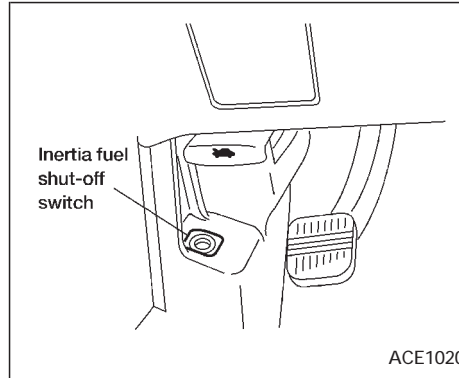

### Inertia fuel shut-off switch

When the vehicle is involved in a collision, the inertia fuel shutoff switch is designed to automatically stop the flow of fuel to the engine. The impact forces needed to trigger the switch do not have to be great. Parking lot bumping or road impacts (such as driving over potholes) may trigger the switch.

Once the inertia fuel shutoff switch is triggered, it must be reset before the engine can be started. If your engine cranks but does not start after a collision, take the following steps to correctly reset the switch:

1. Turn the key in the ignition to OFF.
2. Check under the vehicle for leaking fuel.
3. If you do not see or smell fuel, push down the red reset button on the inertia fuel shut-off switch.
4. Turn the ignition key ON for a few seconds, then turn it OFF.
5. Check under the vehicle again for leaking fuel. If you see or smell fuel, do not start your vehicle again. If no fuel is detected, try to start your vehicle again.

### WARNING

**If you see or smell fuel, do not reset the switch or try to start your vehicle. You could injure yourself or others. Have all the passengers get out of the vehicle and call the local fire department or a towing service.**

## TOW TRUCK TOWING

When towing your vehicle, U.S. States, Canadian Provinces and local regulations for towing must be followed. Incorrect towing equipment could damage your vehicle. Towing instructions are available from an authorized NISSAN dealer. Local service operators are generally familiar with the applicable laws and procedures for towing. To assure proper towing and to prevent accidental damage to your vehicle, NISSAN recommends that you have a service operator tow your vehicle. It is advisable to have the service operator carefully read the following precautions.

### WARNING

- **Never ride in a vehicle that is being towed.**
- **Never get under your vehicle after it has been lifted by a tow truck.**

### CAUTION

- **When towing, make sure that the transmission, axles, steering system and powertrain are in working condition. If any unit is damaged, dollies must be used.**
- **Never use a tow bar that attaches to the bumper when you tow your vehicle. It may damage the bumper and cause damage to the transmission.**
- **When towing with the front wheels on dollies:**  
Turn the ignition key to the OFF position and secure the steering wheel in a straight-ahead position with a rope or similar device. Never place the ignition key in the LOCK position. This will result in damage to the steering lock mechanism. Move the gearshift lever to the N (Neutral) position.
- **When towing with the rear wheels on the ground, release the parking brake.**
- **Attach safety chains for all towing.**

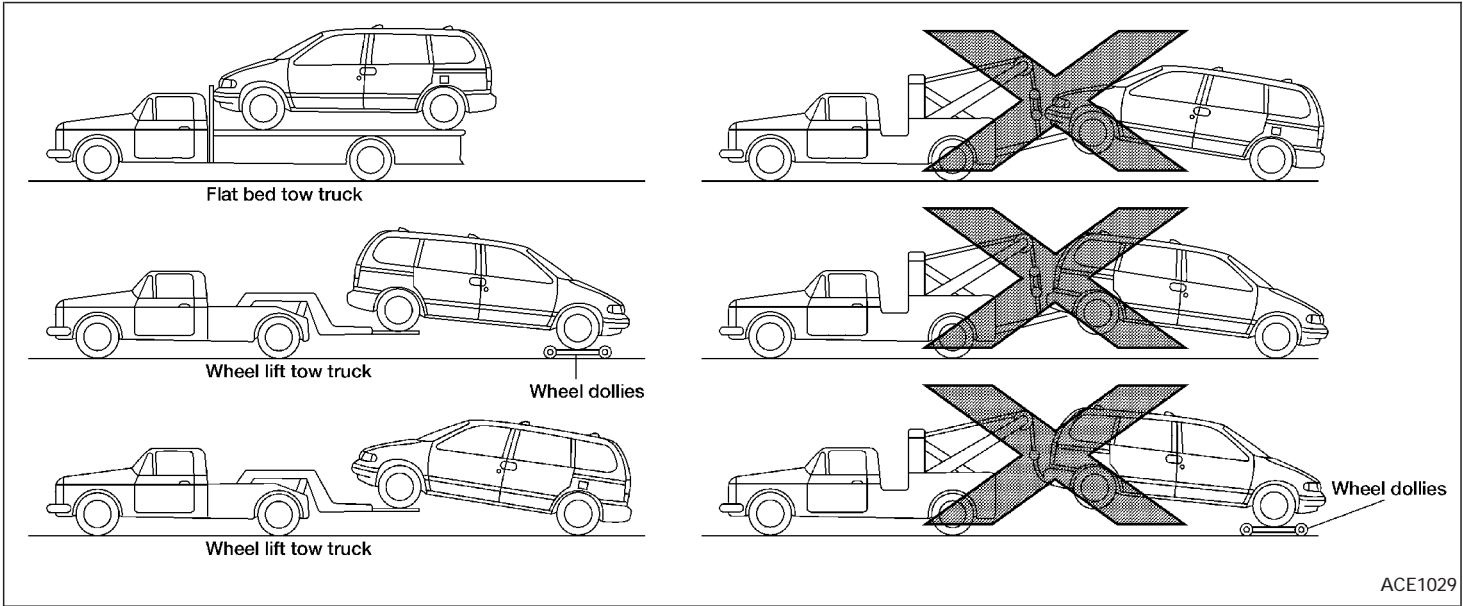

NISSAN recommends that your vehicle be towed with the driving (front) wheels off the ground as illustrated.

- **Speed: Below 60 MPH (97 km/h)**
- **Distance: Less than 500 miles (800 km)**

 **CAUTION**

Never tow the vehicle with the rear wheels raised (with the front wheels on the ground) as this may cause serious and expensive damage to the transmission. If it is necessary to tow the vehicle with the rear wheels raised, always use towing dollies under the front wheels.

- If you have to tow the vehicle with four wheels on ground, observe the following restricted towing speeds and distances:
  - Speed: Below 30 MPH (50 km/h)
  - Distance: Less than 40 miles (65 km)
- Never tow the vehicle from the rear (i.e., backward) with four wheels on the ground as this may cause serious and expensive damage to the transmission.
- Do not tow with a sling type truck, either from the front or the rear. It may cause body damage.
- Never utilize the rear tie down brackets or slots to tow another vehicle as this may cause body damage.

## VEHICLE RECOVERY (freeing a stuck vehicle)

- Tow chains or cables must only be attached to the main structural members of the vehicle.
- Pulling devices should be routed so they do not touch any part of the suspension, steering, brake or cooling systems.
- Always pull the cable straight out from the front or rear of the vehicle. Never pull the vehicle at an angle.
- Pulling devices such as ropes or canvas straps are not recommended for use in vehicle towing or recovery.
- Stand clear of a stuck vehicle.

 **WARNING**

Do not spin your tires at high speed. This could cause them to explode and result in serious injury. Parts of your vehicle could also overheat and be damaged.

# 7 Appearance and care

Cleaning exterior and interior.....7-2

Corrosion protection.....7-4





## CLEANING EXTERIOR AND INTERIOR

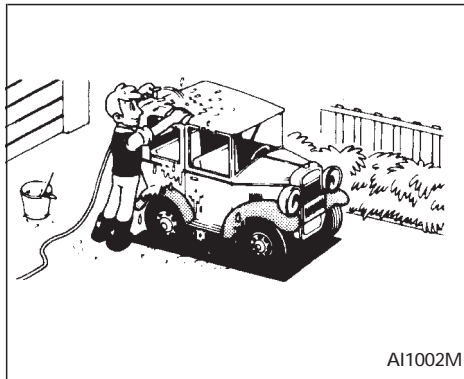

In order to maintain the appearance of your vehicle, it is important to take proper care of it.

In the following cases, please wash your vehicle as soon as possible to protect the paint surface:

- after a rainfall to prevent possible damage from acid rain.
- after driving on coastal roads.
- when contaminants such as soot, bird droppings, tree sap, metal particles or bugs get on the paint surface.

### 7-2 Appearance and care

- when dust or mud builds up on the surface.

Whenever possible, store or park your vehicle inside a garage or in a covered area.

When it is necessary to park outside, park in a shady area or protect the vehicle with a body cover.

**Be careful not to scratch the paint surface when putting on or removing a body cover.**

### Washing

Wash dirt off with a wet sponge and plenty of water. Clean the vehicle thoroughly using a mild soap, a special vehicle soap or general purpose dishwashing liquid mixed with clean, lukewarm (never hot) water.

#### CAUTION

- **Do not use strong household soap, strong chemical detergents, gasoline or solvents.**
- **Do not wash the vehicle in direct sunlight or while the vehicle body is hot, as the surface may become waterspotted.**

- **Avoid using tight-napped or rough cloths such as washing mitts. Care must be taken when removing caked-on dirt or other foreign substances so the paint surface is not scratched or damaged.**

Rinse the vehicle thoroughly with plenty of clean water.

Inside flanges, seams and folds on the doors, hatches and hood are particularly vulnerable to the effects of road salt. Therefore, these areas must be regularly cleaned. Take care that the drain holes in the lower edge of the door are open. Spray water under the body and in the wheel wells to loosen the dirt and wash away road salt.

A damp chamois can be used to dry the vehicle to avoid water spots.

### Waxing

Regular waxing protects the paint surface and helps retain new vehicle appearance. After waxing, polishing is recommended to remove built-up residue and to avoid a "weathered" appearance.

An authorized NISSAN dealer can assist

you in choosing the proper product.

- Wax your vehicle only after a thorough washing. Follow the instructions supplied with the wax.
- Do not use a wax containing any abrasives, cutting compounds or cleaners that may damage the vehicle finish.
- If the surface does not polish easily, use a “road tar” remover and wax again.

Machine compounding or aggressive polishing on a base coat/clear coat paint finish may dull the finish or leave swirl marks.

## Removing spots

Remove tar and oil spots, industrial dust, insects, and tree sap as quickly as possible from the surface of the paint to avoid lasting damage or staining. Special cleaning products are available at an authorized NISSAN dealer or any automotive accessory store.

## Underbody

In areas where road salt is used in winter, the underbody must be cleaned regularly. This prevents dirt and salt from building up and causing underbody and suspension corrosion. Before the winter period and

again in the spring, the underseal must be checked and, if necessary, re-treated.

## Cleaning glass

Use glass cleaner to remove smoke and dust film from the glass surfaces. It is normal for glass to become coated with a film after the vehicle is parked in the hot sun. Glass cleaner and a soft cloth easily remove this film.

### CAUTION

**When cleaning the inside of the window, do not use sharp-edged tools, abrasive cleaners or chlorine-based disinfectant cleaners. They could damage the rear window defogger.**

## Cleaning aluminum alloy wheels

Wash regularly, especially during winter months in areas where road salt is used. Salt could discolor the wheel if not removed.

## Chrome parts

Clean all chrome parts regularly with a non-abrasive chrome polish to maintain the finish.

## Cleaning interior

Occasionally remove loose dust from the interior trim, plastic parts and seats using a vacuum cleaner or soft brush. Wipe the vinyl and leather surfaces with a clean, soft cloth dampened in mild soap solution, then wipe clean with a dry, soft cloth. Before using any fabric protector, read the manufacturer's recommendations. Some fabric protectors contain chemicals that may stain or bleach the seat material.

### CAUTION

- **Never use benzine, thinner, or any similar material.**
- **Leather seats should be regularly coated with a leather wax like saddle soap. Never use car wax.**
- **Never use fabric protectors unless recommended by the manufacturer.**

## Front floor mat positioning aid

This model includes a front floor mat bracket to act as a floor mat positioning aid. NISSAN floor mats, specially designed for your vehicle, incorporate grommets. To in-

stall, simply position the mat using the floor mat bracket hook through the floor mat grommet hole while centering the mat in the footwell.

Periodically check to make certain the mat is properly positioned.

### Floor mats

The use of genuine NISSAN floor mats can extend the life of your vehicle carpet and make it easier to clean the interior. **No matter what mats are used, be sure they are fitted for your vehicle and are properly positioned in the footwell to prevent interference with pedal operation.** Mats should be maintained with regular cleaning and replaced if they become excessively worn.

### Seat belts

The seat belts can be cleaned by wiping them with a sponge dampened in a mild soap solution. Allow the belts to dry completely before using them.

#### WARNING

**Do not allow wet belts to roll up in the retractor. NEVER use bleach, dye, or chemical solvents since these may severely weaken the seat belt webbing.**

## CORROSION PROTECTION

Most common factors contributing to vehicle corrosion:

1. The accumulation of moisture-retaining dirt and debris in body panel sections, cavities, and other areas.
2. Damage to paint and other protective coatings caused by gravel and stone chips or minor traffic accidents.

Environmental factors influence the rate of corrosion.

### Moisture

Accumulation of sand, dirt and water on the vehicle body underside can accelerate corrosion. Wet floor coverings do not dry completely inside the vehicle, and should be removed for drying to avoid floor panel corrosion.

### Relative humidity

Corrosion will be accelerated:

- in areas of high relative humidity.
- in areas where the temperatures stay above freezing.
- where atmospheric pollution exists.

- where road salt is used.

### **Temperature**

A temperature increase accelerates the rate of corrosion to those parts which are not well ventilated.

### **Air pollution**

Industrial pollution, the presence of salt in the air in coastal areas, or heavy road salt use accelerates the corrosion process. Road salt also accelerates the disintegration of paint surfaces.

To protect your vehicle from corrosion:

- wash and wax your vehicle often to keep the vehicle clean.
- always check for minor damage to the paint and repair it as soon as possible.
- keep drain holes at the bottom of the doors open to avoid water accumulation.
- check the underbody for accumulation of sand, dirt or salt. If present, wash with water as soon as possible.



### **CAUTION**

- **NEVER remove dirt, sand or other debris from the passenger compartment by washing it out with a hose. Remove dirt with a vacuum cleaner or broom.**
- **Never allow water or other liquids to come in contact with electronic components inside the vehicle.**

**MEMO**

7-6 **Appearance and care**

# 8 Do-it-yourself

Maintenance precautions .....	8-2
Engine compartment check locations .....	8-3
Engine cooling system .....	8-4
Checking engine coolant level .....	8-4
Changing engine coolant .....	8-5
Engine oil .....	8-5
Checking engine oil level .....	8-5
Changing engine oil .....	8-6
Changing engine oil filter .....	8-7
Automatic transmission fluid (ATF) .....	8-8
Temperature conditions for checking ATF .....	8-8
Power steering fluid.....	8-9
Brake fluid .....	8-10
Window washer fluid .....	8-10
Battery .....	8-11
Jump starting.....	8-12

Drive belts .....	8-12
Spark plug replacement .....	8-12
Air cleaner housing filter .....	8-13
Cabin air filter .....	8-14
Wiper blades .....	8-17
Parking brake check.....	8-19
Brake pedal .....	8-19
Brake booster .....	8-20
Fuses and fusible links.....	8-20
Light bulbs .....	8-22
Headlights .....	8-22
Bulb replacement .....	8-23
Wheels and tires .....	8-27
Types of tires.....	8-28
Tire chains.....	8-29



## MAINTENANCE PRECAUTIONS

When performing any inspection or maintenance work on your vehicle, always take care to prevent serious accidental injury to yourself or damage to the vehicle. The following are general precautions which should be closely observed.

### WARNING

- Park the vehicle on a level surface, apply the parking brake securely and block the wheels to prevent the vehicle from moving. Move the gear-shift lever to N (neutral).
- Be sure the ignition key is OFF when performing any replacement or repair.
- Be sure to turn the ignition key to the OFF or LOCK position. When the ignition key is in the ON or ACC position, the cooling fan may start to operate suddenly even when the engine is not running. To avoid injury always disconnect the negative battery cable before working near the fan.
- If you must work with the engine running, keep your hands, clothing, hair and tools away from moving fans, belts and any other moving parts.

- It is advisable to remove ties and any jewelry, such as rings, watches, etc. before working on your vehicle.
- Always wear eye protection whenever you work on your vehicle.
- If you must run the engine in an enclosed space such as a garage, be sure there is proper ventilation for exhaust gases.
- Never get under the vehicle while it is supported only by a jack. If it is necessary to work under the vehicle, support it with safety stands.
- Keep smoking materials, flame and sparks away from fuel and the battery.
- On gasoline engine models with the multiport fuel injection (MFI) system, the fuel filter or fuel lines should be serviced by an authorized NISSAN dealer because the fuel lines are under high pressure even when the engine is off.

### CAUTION

- Do not work under the hood while the engine is hot. Turn off the engine and wait until it cools down.
- Never connect or disconnect either the battery or any transistorized component connector while the ignition is ON.
- Avoid contact with used engine oil. Improperly disposed motor oil and/or other vehicle fluids can hurt the environment. Always conform to local regulations for disposal of vehicle fluid.

This “Do-it-yourself” section gives instructions regarding only those items which are relatively easy for an owner to perform.

You should be aware that incomplete or improper servicing may result in operating difficulties or excessive emissions, and could affect your warranty coverage. **If in doubt about any servicing, have it done by an authorized NISSAN dealer.**

# ENGINE COMPARTMENT CHECK LOCATIONS

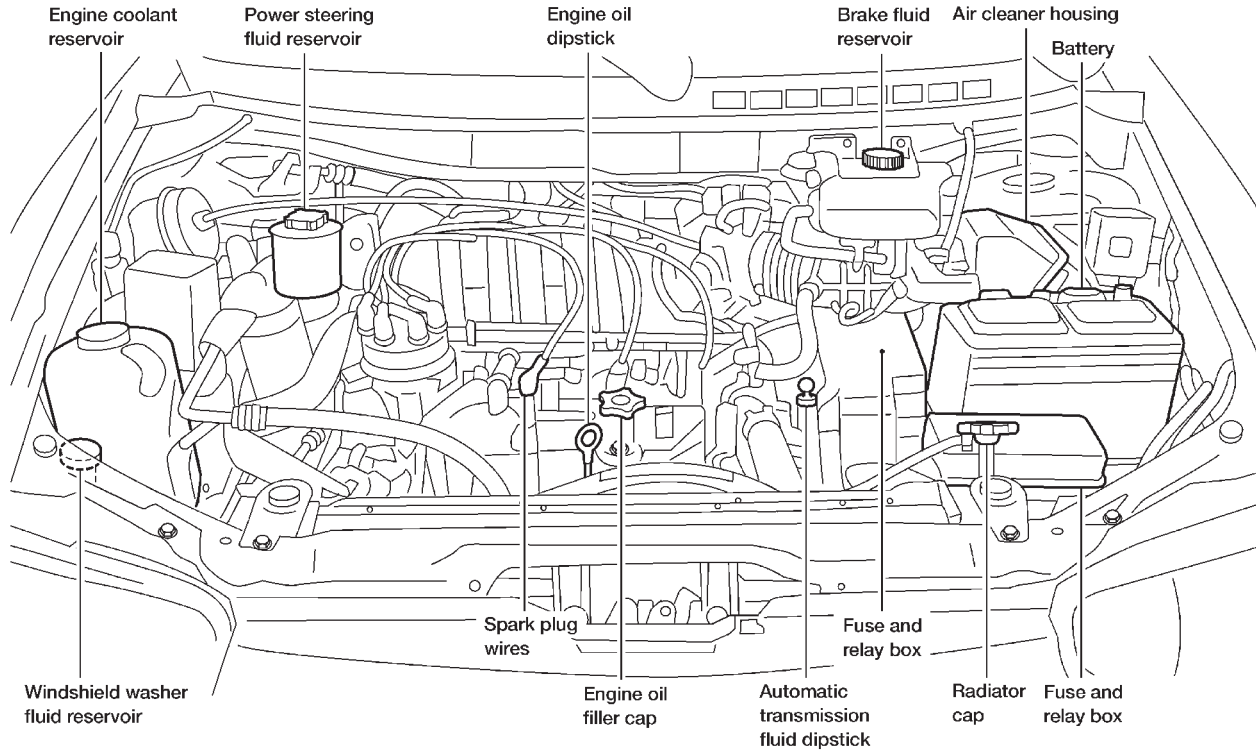

AD11082



# ENGINE COOLING SYSTEM

The engine cooling system is filled at the factory with a high-quality, year-round, anti-freeze coolant solution. The anti-freeze solution contains rust and corrosion inhibitors, therefore additional engine cooling system additives are not necessary.

## CAUTION

When adding or replacing coolant, be sure to use only Genuine NISSAN Anti-freeze Coolant or equivalent with the proper mixture ratio of 50% anti-freeze and 50% demineralized water or distilled water. The use of other types of coolant solutions may damage the engine cooling system.

Outside temperature down to		Genuine NISSAN Anti-freeze Coolant or equivalent	Demineralized or Distilled water
°C	°F		
-35	-30	50%	50%

## WARNING

- Never remove the radiator cap when the engine is hot. Wait until the engine and radiator cool down. Serious burns could be caused by high pressure fluid escaping from the radiator.
- The radiator is equipped with a pressure cap. Use only a genuine NISSAN cap as a replacement.

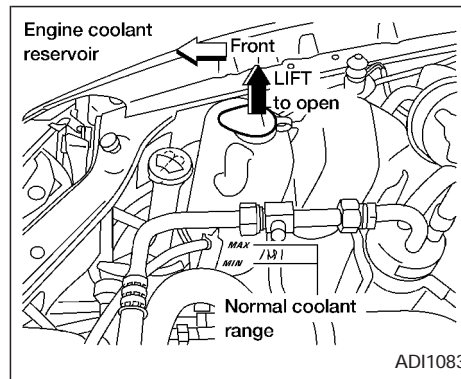

## CHECKING ENGINE COOLANT LEVEL

With coolant reservoir

Check the coolant level in the reservoir tank when the engine is cold. If the coolant level is below MIN, add coolant up to the MAX level. If the reservoir tank is empty, check the coolant level in the radiator **when the engine is cold**. If there is insufficient coolant in the radiator, fill the radiator with coolant up to the filler opening and also add it to the reservoir tank up to the MAX level.

## ENGINE OIL

If the cooling system frequently requires coolant, have it checked by an authorized NISSAN dealer.

### CHANGING ENGINE COOLANT

An authorized NISSAN dealer can change the engine coolant. The service procedure is found in NISSAN's service manual.

**Improper servicing can result in reduced heater performance and engine overheating.**

#### WARNING

- To avoid danger of being scalded, never change the coolant when the engine is hot.
- Never remove the radiator cap when the engine is hot. Serious burns could be caused by high pressure fluid escaping from the radiator.

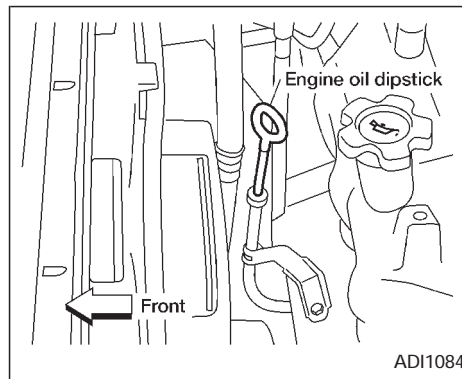

### CHECKING ENGINE OIL LEVEL

1. Park the vehicle on a level surface and apply the parking brake.
2. Start the engine and let it idle until it reaches operating temperature.
3. Turn the engine off. **Wait a few minutes for the oil to drain back into the oil pan.**
4. Remove the dipstick and wipe it clean. Reinsert it all the way.

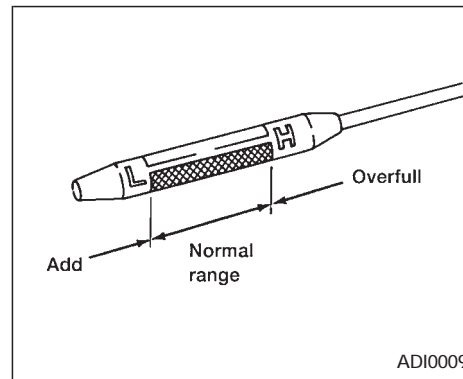

5. Remove the dipstick again and check the oil level. It should be between the H (High) and L (Low) marks. If the oil level is below the L (Low) mark, remove the oil filler cap and pour recommended oil through the opening. **Do not overfill.**
6. Recheck the oil level with the dipstick.

**It is normal to add some oil between oil maintenance intervals or during the break-in period, depending on the severity of operating conditions.**

**⚠ CAUTION**

Oil level should be checked regularly. Operating with an insufficient amount of oil can damage the engine, and such damage is not covered by warranty.

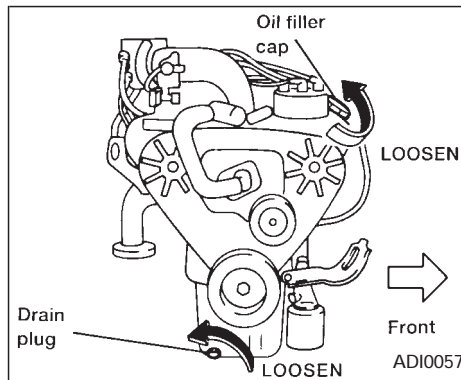

### CHANGING ENGINE OIL

1. Park the vehicle on a level surface and apply the parking brake.
2. Start the engine and let it idle until it reaches operating temperature, then turn it off.
3. Remove the oil filler cap.
4. Place a large drain pan under the drain plug.
5. Remove the drain plug with a wrench and completely drain the oil.

If the oil filter is to be changed, remove and replace it at this time. See “Changing engine oil filter” later in this section.

**⚠ WARNING**

- Be careful not to burn yourself, as the engine oil is hot.
- Prolonged and repeated contact with used engine oil may cause skin cancer.
- Try to avoid direct skin contact with used oil. If skin contact is made, wash thoroughly with soap or hand cleaner as soon as possible.
- Keep used engine oil out of reach of children.

**Waste oil must be disposed of properly. Check your local regulations.**

6. Clean and re-install the drain plug with a new washer. Securely tighten the drain plug with a wrench.

**Drain plug tightening torque:**  
**22 to 29 ft-lb**  
**(29 to 39 N·m)**

Do not use excessive force.

7. Refill the engine with a recommended oil through the oil filler opening then install the oil filler cap securely.  
See the “Technical and consumer information” section for drain and refill capacity.  
The drain and refill capacity depends on the oil temperature and drain time. Use these specifications for reference only. Always use the dipstick to determine when the proper amount of oil is in the engine.
8. Start the engine. Check for leakage around the drain plug. Correct as required.
9. Turn the engine off and wait several minutes. Check the oil level with the dipstick. Add engine oil if necessary.

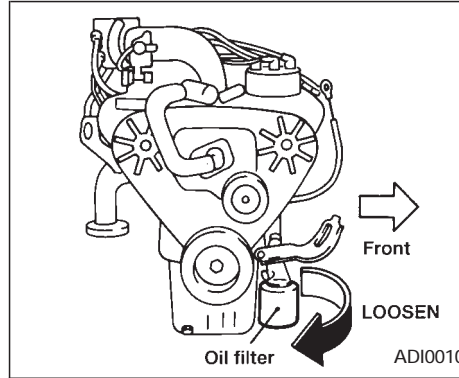

## CHANGING ENGINE OIL FILTER

1. Park the vehicle on a level surface and apply the parking brake.
2. Turn the engine off.
3. Place a large drain pan under the oil filter.
4. Loosen the oil filter with an oil filter wrench. Then, remove the oil filter by turning it by hand.

**⚠ CAUTION**

**Be careful not to burn yourself, as the engine oil may be hot.**

5. Wipe the engine oil filter mounting surface with a clean rag. Be sure to remove any old rubber gasket remaining on the mounting surface of the engine.
6. Coat the rubber gasket on the new filter with clean engine oil.
7. Screw the oil filter in until a slight resistance is felt, then tighten additionally more than 2/3 turn.
8. Start the engine and check for leakage around the oil filter. Correct as required.
9. Turn the engine off and wait several minutes. Check the oil level. Add engine oil if necessary.

# AUTOMATIC TRANSMISSION FLUID (ATF)

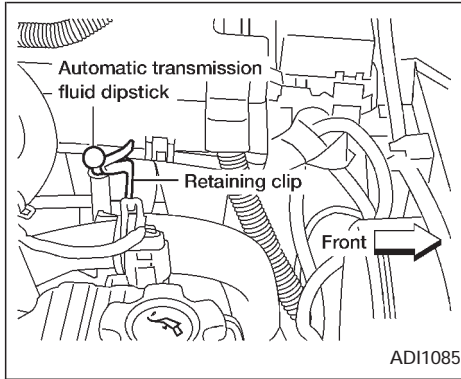

## ⚠ WARNING

- When engine is running, keep hands, jewelry and clothing away from any moving parts such as cooling fan and drive belt.
- Automatic transmission fluid is poisonous and should be stored carefully in marked containers out of the reach of children.

## TEMPERATURE CONDITIONS FOR CHECKING ATF

- Check the fluid level using the HOT range on the dipstick after the following conditions have been met:
    - The engine is warmed up to operating temperature.
    - The vehicle is driven at least 15 minutes.
    - The automatic transmission fluid is warmed to between 150°F and 170°F (66°C and 77°C).
  - The fluid can be checked at fluid temperatures of 70°F to 95°F (21°C to 35°C) using the COLD range on the dipstick after the engine is warmed up and before driving. However, the fluid should be re-checked using the HOT range.
1. Park the vehicle on a level surface and set the parking brake.
  2. Start the engine, then move the shift selector lever through the range of gears, ending in P (Park).

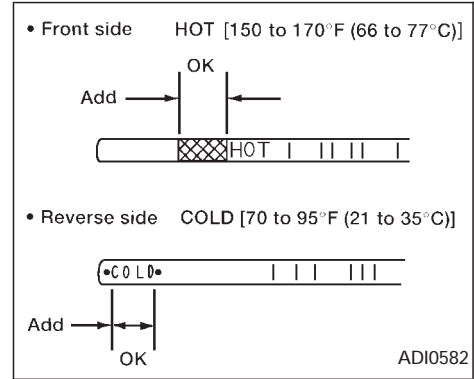

3. Check the fluid level with the engine idling.
4. Remove the dipstick and wipe it clean with a lint-free cloth.
5. Reinsert the dipstick into the charging pipe as far as it goes.
6. Remove the dipstick and note the reading. If the level is at the low side of either range, add fluid through the charging pipe.

## POWER STEERING FLUID

### CAUTION

#### DO NOT OVERFILL.

Use **ONLY** Nissan Matic 'D' (Continental U.S. and Alaska) or Genuine Nissan Automatic Transmission Fluid (Canada). Dexron™ III/Mercon™ or equivalent may also be used. Outside the continental United States and Alaska contact a Nissan dealership for more information regarding suitable fluids, including recommended brand(s) of Dexron™ III/Mercon™.

#### NOTE:

If the vehicle has been driven for a long time at high speeds, or in city traffic in hot weather, or if it is being used to pull a trailer, the accurate fluid level cannot be read. You should wait until the fluid has cooled down (about 30 minutes).

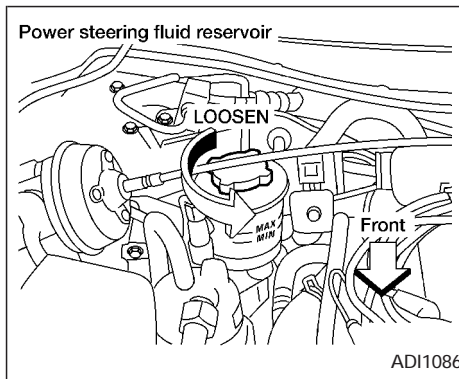

Check the fluid level in the reservoir.

The fluid level should be checked by looking at the MAX and MIN lines at fluid temperatures of 32°F to 86°F (0°C to 30°C).

If the fluid is below the MIN line, add automatic transmission fluid type F up to the MAX line.

### CAUTION

- Do not overfill.
- The recommended fluid is type F automatic transmission fluid or equivalent.

## BRAKE FLUID

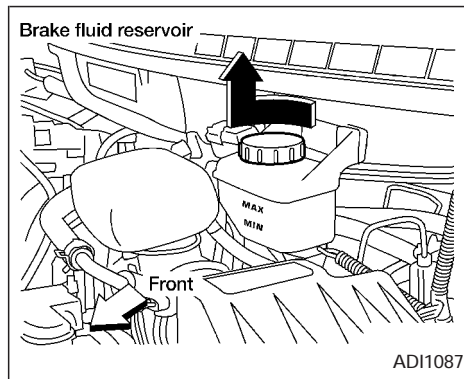

Check the fluid level in the reservoir. If the fluid is below the MIN line or the brake warning light comes on, add **DOT 3** fluid up to the MAX line. If fluid must be added frequently, the system should be thoroughly checked by an authorized NISSAN dealer. For further brake fluid specification information, refer to the "Technical and Consumer Information" section in this manual.

### WARNING

Use only new fluid. Old, inferior, or contaminated fluid may damage the brake system. The use of improper fluids can damage the brake system and affect the vehicle's stopping ability.

### CAUTION

Do not spill the fluid on painted surfaces. This will damage the paint. If fluid is spilled, wash with water.

## WINDOW WASHER FLUID

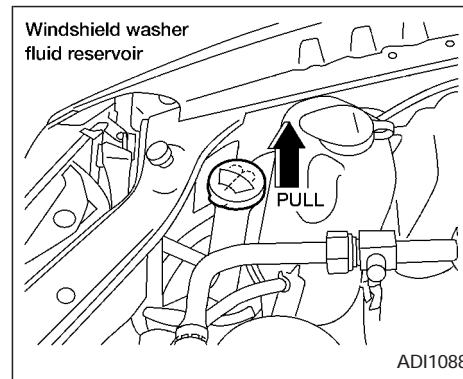

Add fluid when the low washer fluid warning light comes on. To check the fluid level, look down the fill tube of the washer fluid reservoir in the engine compartment.

To add fluid, remove the reservoir cap and refill the reservoir.

This reservoir serves both the front and rear washer systems.

### CAUTION

Do not substitute engine anti-freeze coolant for window washer solution. This may result in damage to the paint.

# BATTERY

- Keep the battery surface clean and dry. Any corrosion should be washed off with a solution of baking soda and water.
- Make certain the terminal connections are clean and securely tightened.
- If the vehicle is not to be used for 30 days or longer, disconnect the negative (-) battery terminal cable to prevent discharging.

## WARNING

- **Do not expose the battery to flames or electrical sparks. Hydrogen gas generated by battery action is explosive. Do not allow battery fluid to contact your skin, eyes, fabrics, or painted surfaces. After touching a battery or battery cap, do not touch or rub your eyes. Thoroughly wash your hands. If the acid contacts your eyes, skin or clothing, immediately flush with water for at least 15 minutes and seek medical attention**
- **When working on or near a battery, always wear suitable eye protection and remove all jewelry.**

- **Keep the battery out of the reach of children.**

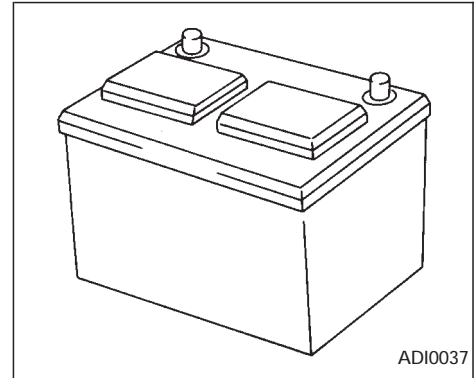

Check the fluid level in each cell. It should be between the MAX and MIN lines.

If it is necessary to add fluid, add only distilled water to bring the level to the indicator in each filler opening. **Do not overfill.**

1. Remove the cell plugs using a suitable tool.
2. Add distilled water up to the MAX level.
3. Tighten cell plugs.



## DRIVE BELTS

### JUMP STARTING

If jump starting is necessary, see the “In case of emergency” section. If the engine does not start by jump starting, the battery may have to be replaced. Contact an authorized NISSAN dealer.

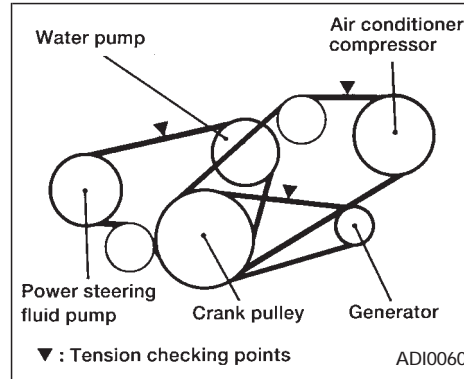

#### **⚠ WARNING**

**Be sure the ignition key is OFF. The engine could rotate unexpectedly.**

1. Visually inspect each belt for signs of unusual wear, cuts, fraying or looseness. If the belt is loose or in poor condition, have it replaced or adjusted by an authorized NISSAN dealer.
2. Have the belts checked regularly for condition and tension in accordance with the maintenance schedule found in the “Maintenance” section of this manual.

## SPARK PLUG REPLACEMENT

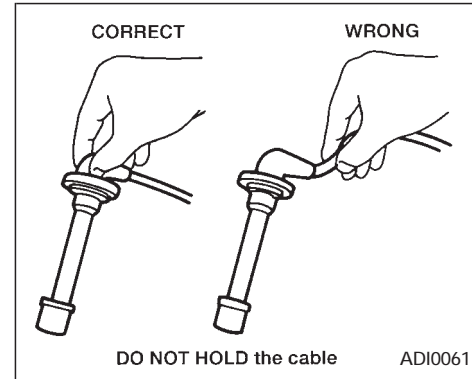

#### **⚠ WARNING**

**Be sure the engine and ignition switch are off and that the parking brake is engaged securely.**

#### **⚠ CAUTION**

**Be sure to use the correct socket to remove the plugs. An incorrect socket can cause damage.**

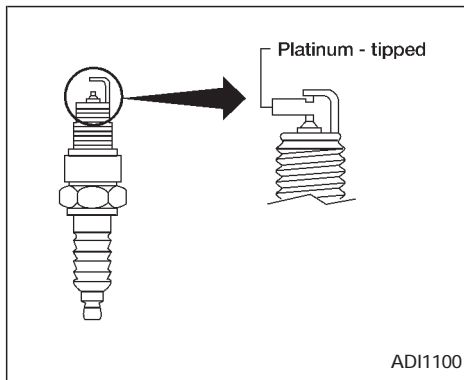

### Platinum-tipped spark plug

It is not necessary to replace platinum-tipped spark plugs as frequently as conventional type spark plugs because they last much longer. Follow the maintenance schedule, but do not reuse the spark plugs by cleaning or regapping.

- **Always replace spark plugs with recommended or equivalent ones.**

1. Disconnect the spark plug cables from the spark plugs.

When disconnecting, always hold the boots, not the cables.

2. Remove the spark plugs with a spark plug socket. The plug socket has a rubber seal that holds the spark plug so it does not fall when it is pulled out. Make sure each spark plug is snugly fitted into the plug socket.
3. Fit the new plugs, one at a time, into the spark plug socket and install them. **Use only the specified spark plugs.** Turn each plug several full turns by hand, then tighten with the spark plug socket to the correct torque. Do not overtighten.

**Spark plug tightening torque:**  
**14 to 22 ft-lb (20 to 29 N·m)**

4. Holding the boot, re-connect each high tension cable to its proper spark plug by pushing it on until you feel a snap.

## AIR CLEANER HOUSING FILTER

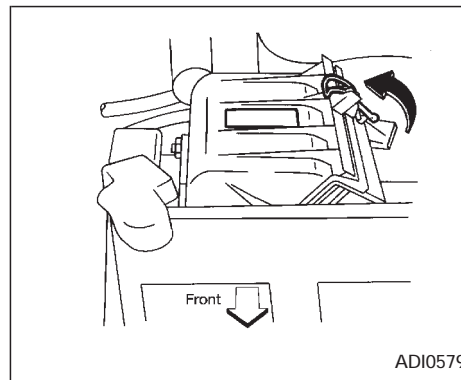

The filter should not be cleaned and reused. Replace it according to the maintenance intervals shown in the "Maintenance" section of this manual. When replacing the filter, unclip the four clamps and remove the filter. Wipe the inside of the air cleaner housing and the cover with a damp cloth when replacing filter.

**⚠ WARNING**

- Operating the engine with the air cleaner off can cause you or others to be burned. The air cleaner not only cleans the air, it stops flame if the engine backfires. If it isn't there and the engine backfires, you could be burned. Don't drive with it off, and be careful working on the engine with the air cleaner off.
- Never pour fuel into the throttle body or attempt to start the engine with the air cleaner removed. Doing so could result in serious injury.

## CABIN AIR FILTER

The cabin air filter restricts the entry of airborne dust and pollen particles and reduces some objectionable outside odors. The filter is located just in front of the windshield under the cowl cover on the passenger side of the vehicle.

To replace the filter, perform the following procedure.

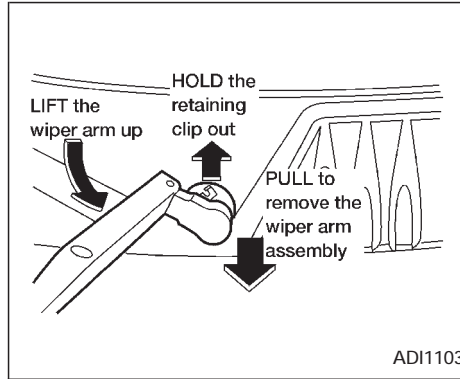

1. Remove the windshield wiper arms.
  - Lift the wiper arm away from the windshield surface until the wiper is perpendicular to the windshield.
  - Lift and remove the wiper arm, while holding the small retaining clip at the base of wiper arm outward.

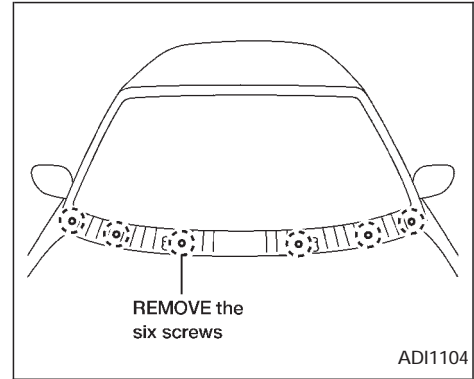

2. Remove the cowl cover.
  - Remove the six screws.
  - Open the hood.

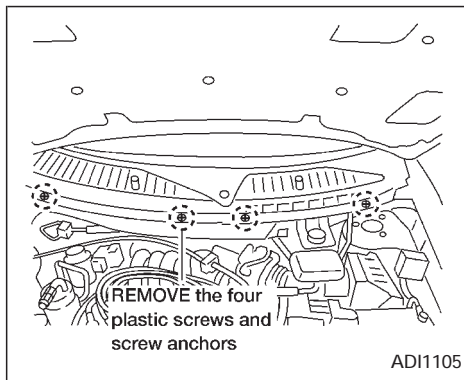

- Remove the four plastic screws from the forward edge of the cowl cover.
- Remove the four plastic screw anchors.

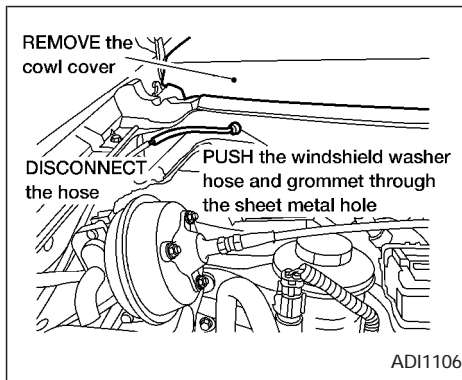

- Disconnect the windshield washer hose at the passenger side rear corner of the engine compartment.
- Push the windshield washer hose and the grommet through the sheet metal hole.
- Lift the cowl cover and remove it from the vehicle.

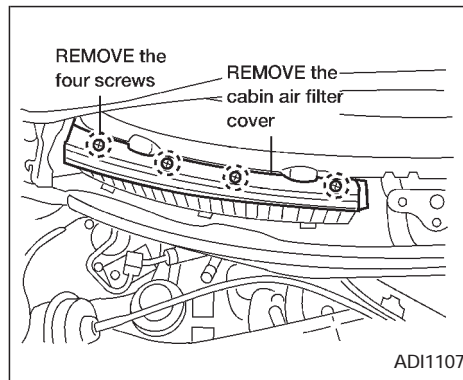

3. Locate the cabin air filter on the passenger side of the vehicle.
- Remove the four screws from the cabin air filter cover.
  - Remove the cabin air filter cover.

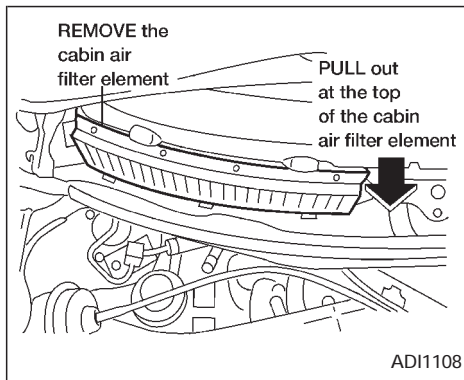

- Remove the cabin air filter element by pulling forward on the top surface of the filter and lifting.

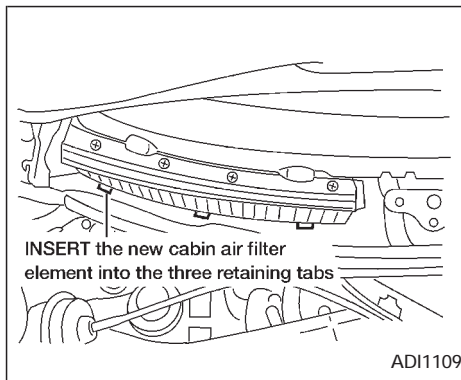

4. Install the new cabin air filter element into the filter retaining frame, ensure that you insert the three retaining tabs in the bottom of the filter frame.
5. Install the filter top cover and the four screws.
6. Feed the windshield washer hose from the cowl cover through the hole in the sheet metal.
  - Ensure that you fully seat the rubber grommet into the sheet metal hole.
7. Reconnect the windshield washer hose.

8. Position the cowl cover in place.
9. Reinstall the four screw anchors and the four screws.
10. Close the hood.
11. Install the six screws in the cowl cover.
12. Install the windshield wiper arms.
  - Push the wiper arm downward onto the wiper arm pivot until the small retaining clip snaps into the locked position.
  - Lower the wiper arm blade onto the windshield surface.

# WIPER BLADES

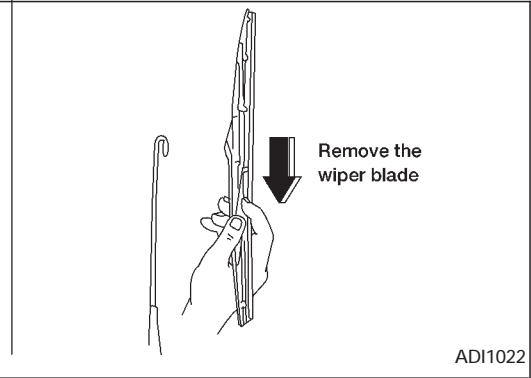
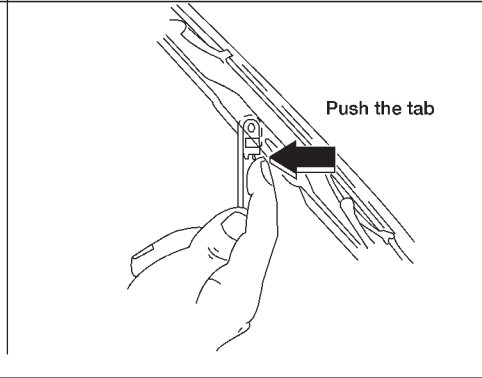
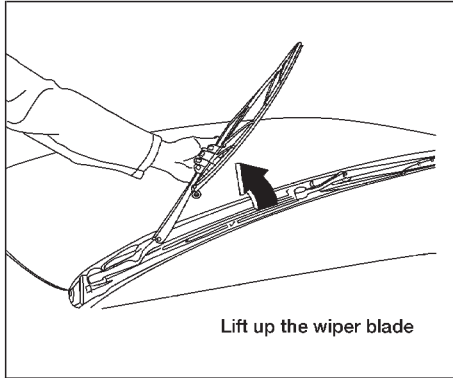

ADI1022

## CLEANING

If your windshield is not clear after using the windshield washer or if the wiper blade chatters when running, wax or other material may be on the blade or windshield.

Clean the outside of the windshield with a washer solution or a mild detergent. Your windshield is clean if beads do not form when rinsing with clear water.

Clean the blade by wiping it with a cloth soaked in a washer solution or a mild detergent. Then, rinse the blade with clear water. If your windshield is still not clear after

cleaning the blades and using the wipers, replace the blades.

## REPLACEMENT

1. Lift the wiper arm away from the windshield.
2. Push the tab, then move the wiper blade down the wiper arm to remove.
3. Remove the wiper blade.
4. Insert the new wiper blade onto the wiper arm until it clicks into place.

## CAUTION

- After wiper blade replacement, return the wiper arm to its original position: Otherwise it may be damaged when the engine hood is opened.
- Make sure the wiper blade contacts the glass, otherwise the arm may be damaged from wind pressure.

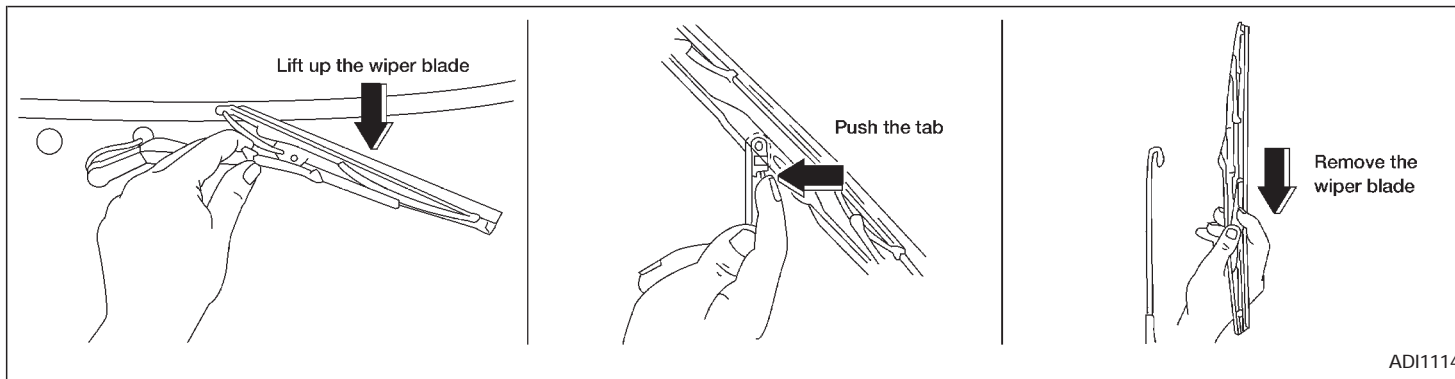

## Rear wiper blade replacement

1. Lift the wiper arm away from the windshield.
2. Push the tab, then move the wiper blade down the wiper arm to remove.
3. Insert a new wiper blade onto the wiper arm and press down until the blade clicks into place.

## PARKING BRAKE CHECK

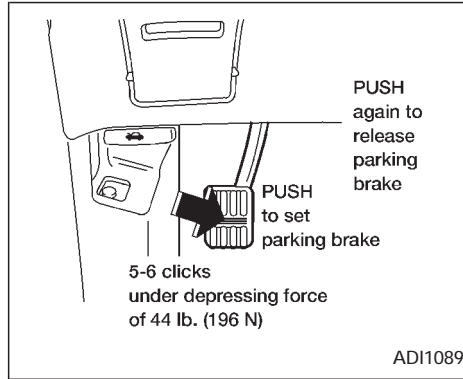

From the released position, push the parking brake foot lever down. If the number of clicks is out of the range listed above, see an authorized NISSAN dealer.

## BRAKE PEDAL

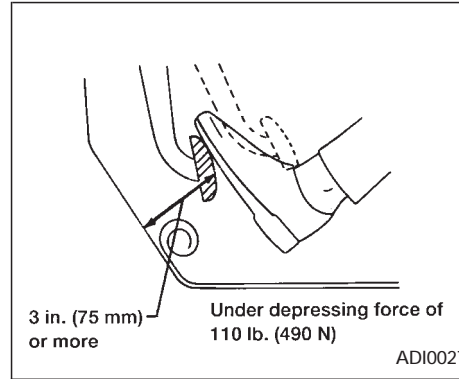

With the engine running, check the distance between the upper surface of the pedal and the floor. If it is out of the range shown above, see an authorized NISSAN dealer.

### Self-adjusting brakes

Your vehicle is equipped with self-adjusting brakes.

The front disc-type brakes self-adjust every time the brake pedal is applied. The rear drum-type brakes also self-adjust every time the brake pedal is applied. If the brake pedal goes down farther than normal, see an authorized NISSAN dealer.

### WARNING

See an authorized NISSAN dealer and have it checked if the brake pedal height does not return to normal.

### Brake pad wear indicators

The disc pads on your vehicle have audible wear indicators. When a brake pad requires replacement, it makes a high pitched scraping or screeching sound when the vehicle is in motion whether or not the brake pedal is depressed. Have the brakes checked as soon as possible if the wear indicator sound is heard.

Under some driving or climate conditions, occasional brake squeak, squeal or other noise may be heard. Occasional brake noise during light to moderate stops is normal and does not affect the function or performance of the brake system.

The rear drum brakes (if so equipped) do not have audible wear indicators. If you ever hear an unusually loud noise from the rear drum brakes, have them inspected as soon as possible by an authorized NISSAN dealer.



## BRAKE BOOSTER

**Proper brake inspection intervals should be followed.** For more information regarding brake inspections, see the appropriate maintenance schedule information in the "Maintenance" section of this manual.

Check the brake booster function as follows:

1. With the engine off, press and release the brake pedal several times. When brake pedal movement (distance of travel) remains the same from one pedal application to the next, continue on to the next step.
2. While depressing the brake pedal, start the engine. The pedal height should drop a little.
3. With the brake pedal depressed, turn the engine off. Keep the pedal depressed for about 30 seconds; the pedal height should not change.
4. Run the engine for one minute without depressing the brake pedal, then turn it off. Depress the brake pedal several times. The pedal travel distance will decrease gradually with each depression as the vacuum is released from the booster.

If the brakes do not operate properly, see an authorized NISSAN dealer.

## FUSES AND FUSIBLE LINKS

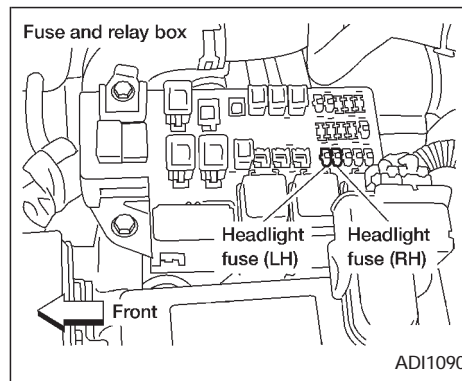

### Engine compartment (headlight fuses)

**⚠ CAUTION**

**Never use a fuse of a higher amperage rating than that specified on the fuse box cover. This could damage the electrical system or cause a fire.**

If a headlight does not come on, check for an open fuse:

The left headlight (driver's side) and right headlight (passenger side) fuses are lo-

cated in the left-hand fuse box, near the radiator cap.

1. Turn the headlight switch to the OFF position.
2. Open the engine hood.
3. Remove the fuse box cover.
4. Remove the fuse with the fuse puller attached to the passenger compartment fuse box cover.
5. If the fuse is open, replace it with a new fuse.
6. If a new fuse opens again, have the electrical system checked and repaired by an authorized NISSAN dealer.

If the electrical equipment does not operate and fuses are in good condition, check the fusible links. If any of these fusible links are melted, replace only with genuine NISSAN parts.

If the new fusible link melts again, have the system checked and repaired by an authorized NISSAN dealer.

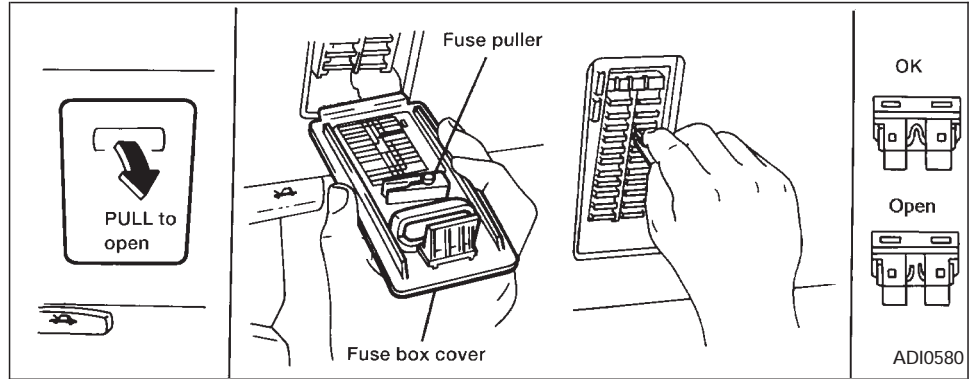

### Passenger compartment

#### CAUTION

**Never use a fuse of a higher amperage rating than that specified on the fuse box cover. This could damage the electrical system or cause a fire.**

If the electrical equipment does not operate, check for an open fuse:

1. Remove the key from the ignition.
2. Open the fuse box cover. Refer to the fuse label on the fuse box cover to locate

the fuse in question.

3. Remove the fuse with the fuse puller.
4. If the fuse is open, replace it with a new fuse.
5. If a new fuse opens again, have the electrical system checked and repaired by an authorized NISSAN dealer.

# LIGHT BULBS

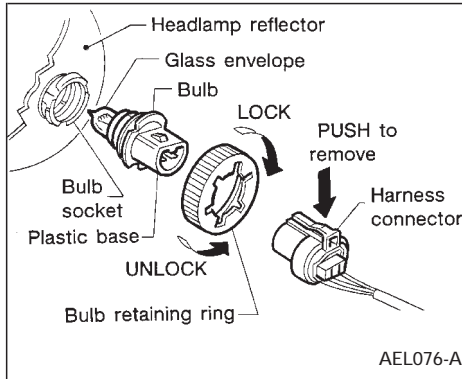

## HEADLIGHTS

The headlight is a semi-sealed beam type which uses a replaceable headlight (halogen) bulb. A bulb can be replaced from inside the engine compartment without removing the headlight assembly.

### CAUTION

- **High pressure halogen gas is sealed inside the halogen bulb. The bulb may break if the glass envelope is scratched or the bulb is dropped.**

- **When handling the bulb, do not touch the glass envelope.**

## Removing the headlight bulb

1. Disconnect the negative (-) battery cable.
2. Disconnect the electrical connector from the rear end of the bulb.
3. Turn the bulb retaining ring counterclockwise until it is free from the headlight reflector, then remove it.
4. Remove the headlight bulb by pulling it straight out. Do not shake or rotate the bulb when removing it.

## Replacing the headlight bulb

1. Insert the bulb into the headlight reflector with the flat side of the plastic base facing upward.
2. Install the bulb retaining ring and turn it clockwise until it stops.
3. Push the electrical connector into the bulb plastic base until it snaps and stops.

### CAUTION

#### DO NOT TOUCH THE BULB.

- Use the same number and wattage as originally installed:  
**Wattage 65/55**  
**Bulb no. 9007 (HB5)**
- **Aiming is not necessary after replacing the bulb. When aiming adjustment is necessary, contact your NISSAN dealer.**
- **Do not leave the bulb out of the headlight reflector for a long period of time as dust, moisture and smoke may enter the headlight body and affect the performance of the headlight.**

## BULB REPLACEMENT

Item	Wattage (W)	Bulb No.
Headlight assembly		
High/Low	65/55	9007 (HB5)
Front turn signal light	8.25/27	3157
Front combination light:		
Front side marker light	3.8	194
Parking/Cornering	8.25/27	3157
Rear combination light:		
Turn signal	27	3156
Stop/Tail	8.25/27	3157
Rear side marker light	3.8	194
Back-up light	27	3156
License plate light	3.8	194
High-mounted stop light	12.8	912
Interior lights	12	211-2
Personal reading light	10	578
Luggage compartment light	12	211-2
Steplight	3.8	194
Spotlight	10	578

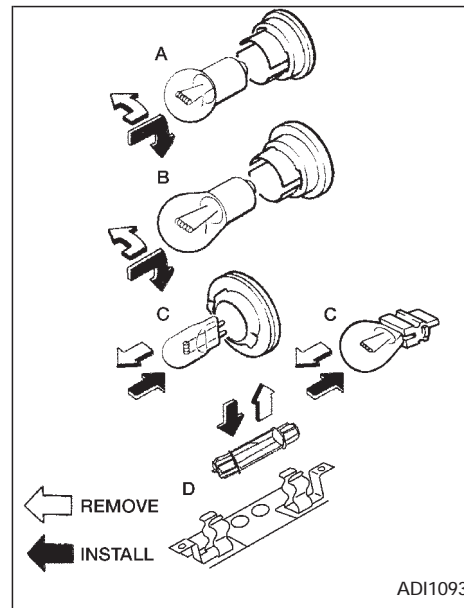
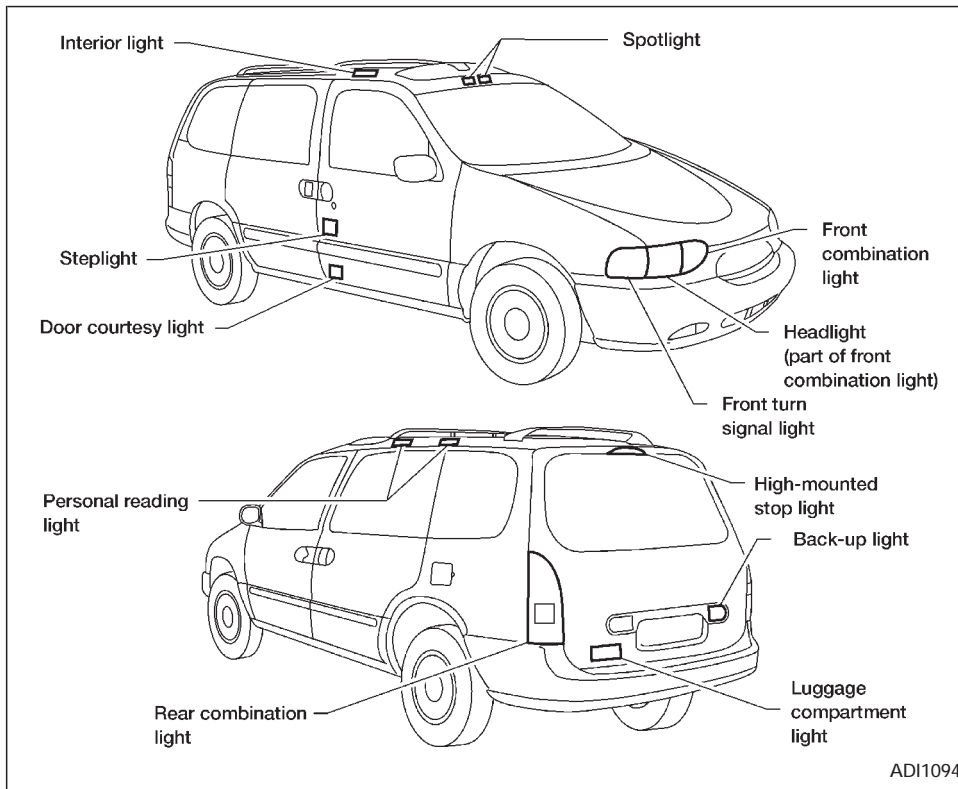

## Replacement procedures

All lights (except for headlights) are either type A, B, C or D. When replacing a bulb, first remove the lens and/or cover.

### Rear combination light

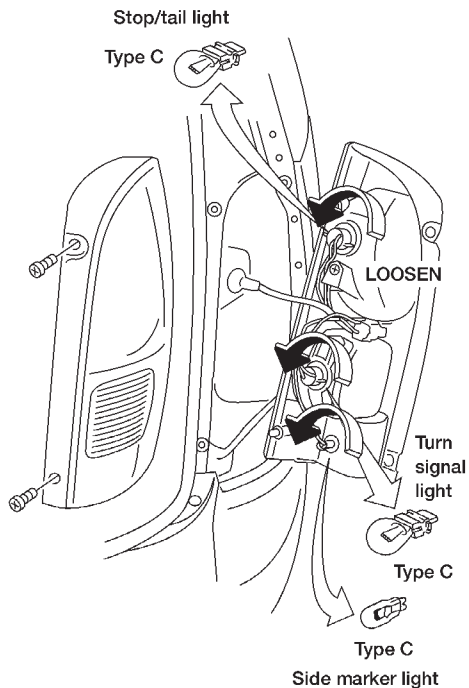

### Back-up light

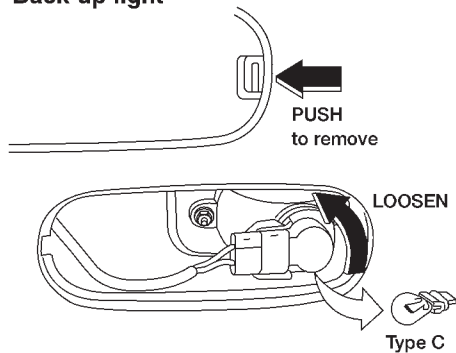

### License plate light

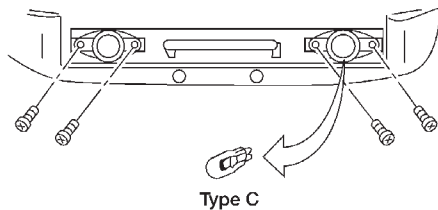

### Steplight

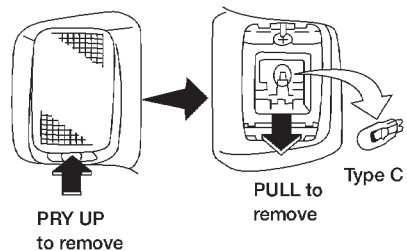

### High-mounted stop light

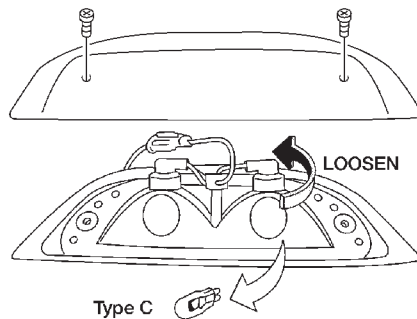

AD11122

### Front turn signal light

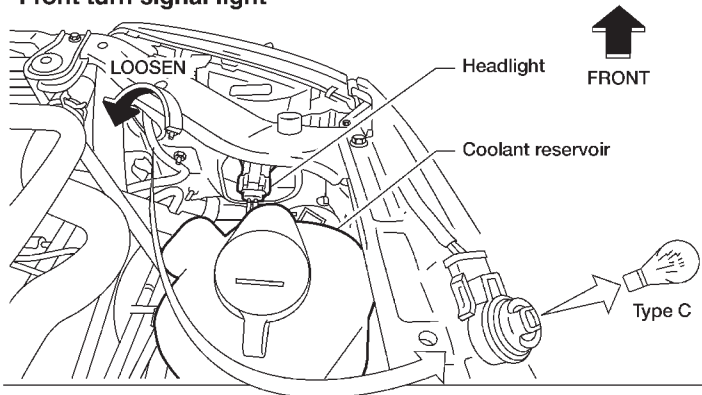

### Front combination light

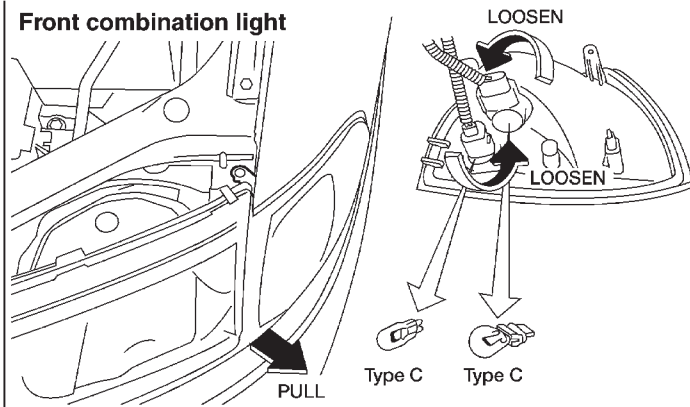

### Spotlight

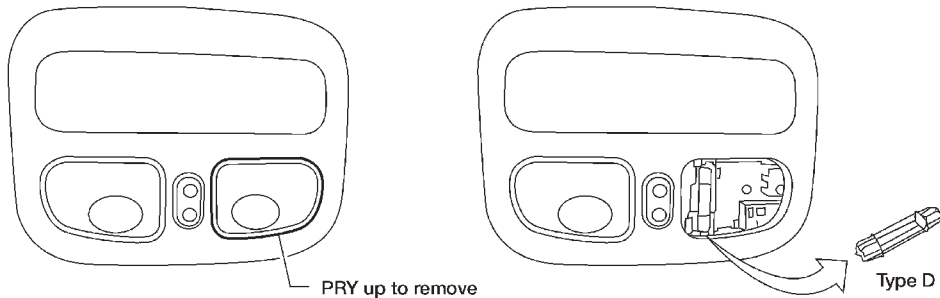

ADI1096

## WHEELS AND TIRES

### Luggage compartment light

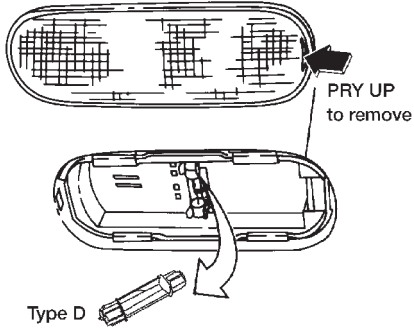

### Interior light

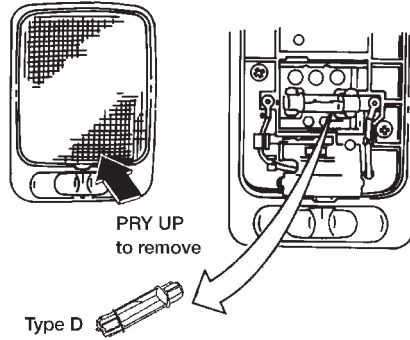

### Personal reading light

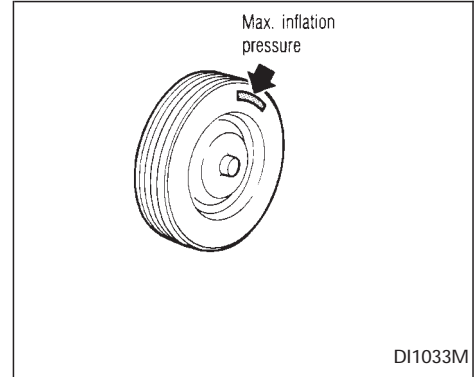
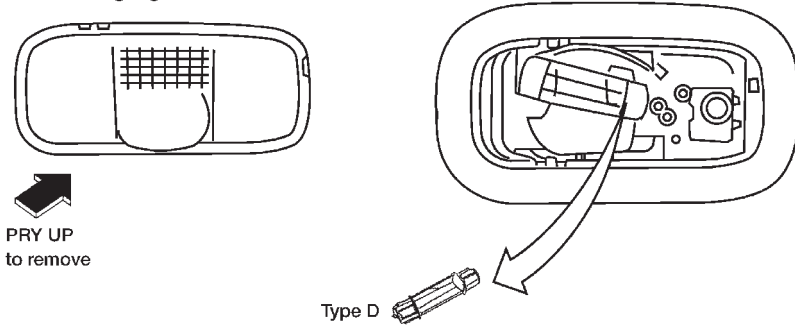

**If you have a flat tire, see the “In case of emergency” section of this manual.**

### Maximum inflation pressure

Do not exceed the maximum inflation pressure shown on the side wall of the tire.

### Tire inflation pressure

Periodically check the tire pressure (including the spare). Incorrect tire pressure may adversely affect tire life and vehicle handling. Tire pressure should be checked when tires are COLD. Tires are considered COLD after the vehicle has been parked for



three or more hours, or driven less than 1 mile (1.6 km). COLD tire pressures are shown on the tire placard affixed to the glove box door.

 **WARNING**

- **Improperly inflated tires can fail suddenly and cause an accident.**
- **The vehicle capacity weight is indicated on the tire placard. Do not load your vehicle beyond this capacity. Overloading your vehicle may result in reduced tire life, unsafe operating conditions due to premature tire failure, or unfavorable handling characteristics and could also lead to a serious accident. Loading beyond the specified capacity may also result in failure of other vehicle components.**
- **Before taking a long trip, or whenever you have loaded your vehicle heavily, use a tire pressure gauge to ensure that the tire pressure is at the specified level.**

- **Do not drive your vehicle over 85 MPH (140 km/h) unless it is equipped with high speed capability tires. Driving faster than 85 MPH (140 km/h) may result in tire failure, loss of control and possible injury.**

### Types of tires

 **WARNING**

**When changing or replacing tires, be sure all four tires are of the same type (i.e., Summer, All Season or Snow) and construction. An authorized NISSAN dealer may be able to help you with information about tire type, size, speed rating and availability. Replacement tires may have a lower speed rating than the factory equipped tires, and may not match the potential maximum vehicle speed. Never exceed the maximum speed rating of the tire.**

### All Season tires

NISSAN specifies All Season tires to provide good performance all year, including snowy and icy road conditions. All Season

Tires are identified by “ALL SEASON” and/or “M&S” on the tire sidewall. Snow tires have better snow traction than All Season tires and may be more appropriate in some areas.

### Snow tires

If snow tires are needed, it is necessary to select tires equivalent in size and load rating to the original equipment tires. If you do not, it can adversely affect the safety and handling of your vehicle.

Generally, snow tires have lower speed ratings than factory equipped tires and may not match the potential maximum vehicle speed. Never exceed the maximum speed rating of the tire.

If you operate your vehicle in snowy or icy conditions, NISSAN recommends the use of snow or all season tires on all four wheels.

For additional traction on icy roads, studded tires may be used. However, some U.S. states and Canadian provinces prohibit their use. Check local, state and provincial laws before installing studded tires. Skid and traction capabilities of studded snow tires on wet or dry surfaces may be poorer than that of non-studded snow tires.

## Tire chains

Use of tire chains may be prohibited according to location. Check the local laws before installing tire chains. When installing tire chains, make sure they are of proper size for the tires on your vehicle and are installed according to the chain manufacturer's suggestions. **Use only SAE Class "S" chains.** Other types may damage your vehicle. Use chain tensioners when recommended by the tire chain manufacturer to ensure a tight fit. Loose end links of the tire chain must be secured or removed to prevent the possibility of whipping action damage to the fenders or undercarriage. If possible, avoid fully loading your vehicle when using tire chains. In addition, drive at a reduced speed. Do not exceed maximum speed suggested by the chain manufacturer. Otherwise, your vehicle may be damaged and/or vehicle handling and performance may be adversely affected.

Never install tire chains on T-type and small size spare tires. Do not use tire chains on dry roads.

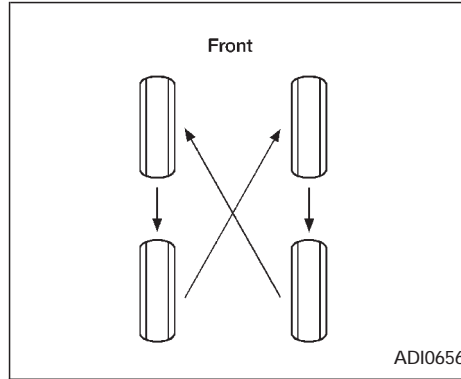

## Tire rotation

NISSAN recommends rotating the tires every 7,500 miles (12,000 km).

Tighten wheel nuts to 72 to 87 ft-lb (98 to 118 N·m).

See "Flat tire" in the "In case of emergency" section for tire replacing procedures.

## WARNING

- After rotating the tires, adjust the tire pressure.
- Retighten the lug nuts after the wheels have been run for the first 600 miles (1,000 km) (also in cases of a flat tire, etc.).
- Do not include the T-type spare tire or any other small size spare tire in the tire rotation.

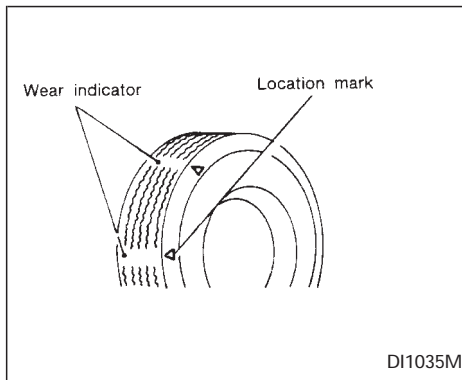

DI1035M

## Tire wear and damage

### WARNING

- Tires should be periodically inspected for wear, cracking, bulging, or objects caught in the tread. If excessive wear, cracks, bulging, or deep cuts are found, the tire should be replaced.
- The original tires have a built-in tread wear indicator. When the wear indicator is visible, the tire should be replaced.

- Improper service for a T-type spare tire may result in serious personal injury. If it is necessary to repair the T-type spare tire, contact an authorized NISSAN dealer.

## Changing tires and wheels

When replacing a tire, use the same size, tread design, speed rating and load carrying capacity as originally equipped. Recommended types and sizes are shown in "Wheels and tires" in the "Technical and consumer information" section of this manual.

### WARNING

- The use of tires other than those recommended or the mixed use of tires of different brands, construction (bias, bias-belted or radial), or tread patterns can adversely affect the ride, braking, handling, ground clearance, body-to-tire clearance, snow chain clearance, speedometer calibration, headlight aim and bumper height. Some of these effects may lead to accidents and could result in serious personal injury.

- If the wheels are changed for any reason, always replace with wheels which have the same offset dimension. Wheels of a different offset could cause early tire wear, possibly degraded vehicle handling characteristics and/or interference with the brake discs/drums. Such interference can lead to decreased braking efficiency and/or early brake pad/shoe wear.
- Do not install a deformed wheel or tire even if it has been repaired. Such wheels or tires could have structural damage and could fail without warning.
- The use of retread tires is not recommended.

## Wheel balance

Unbalanced wheels may affect vehicle handling and tire life. Even with regular use, wheels can get out of balance. Therefore, they should be balanced as required.

Wheel balance service should be performed with the wheels off the vehicle. Spin balancing the front wheels on the vehicle could lead to transmission damage.

## Care of wheels

- Wash the wheels when washing the vehicle to maintain their appearance.
- Clean the inner side of the wheels when the wheel is changed or the underside of the vehicle is washed.
- Do not use abrasive cleaners when washing the wheels.
- Inspect wheel rims regularly for dents or corrosion. Such damage may cause loss of pressure or poor seal at the tire bead.
- NISSAN recommends waxing the road wheels to protect against road salt in areas where it is used during winter.

## Spare tire (T-type spare tire)

US only. Canadian vehicles are equipped with a full size spare tire. Observe the following precautions if the T-type spare tire must be used, otherwise your vehicle could be damaged or involved in an accident.

### WARNING

- **The T-type spare tire should be used only for emergency. It should be replaced by the standard tire at the first opportunity.**
- **Drive carefully while the T-type spare tire is installed. Avoid sharp turns and abrupt braking while driving.**
- **Periodically check T-type spare tire inflation pressure, and always keep it at 60 psi (420 kPa, 4.2 bar).**
- **Do not drive your vehicle at speeds faster than 50 MPH (80 km/h).**
- **When driving on roads covered with snow or ice, the T-type spare tire should be used on the rear wheel and the original tire used on the front wheels (drive wheels). Use tire chains only on the front two original tires.**
- **Tire tread of the T-type spare tire will wear at a faster rate than the original tire. Replace the T-type spare tire as soon as the tread wear indicators appear.**
- **Do not use the T-type spare tire on other vehicles.**

- **Do not use more than one T-type spare tire at the same time.**
- **Do not tow a trailer while the T-type spare tire is installed.**

### CAUTION

- **Do not use tire chains on a T-type spare tire. Tire chains will not fit properly on the T-type spare tire and may cause damage to the vehicle.**
- **Because the T-type spare tire is smaller than the original tire, ground clearance is reduced. To avoid damage to the vehicle do not drive over obstacles. Also do not drive the vehicle through an automatic car wash since it may get caught.**

**MEMO**

# 9 Maintenance

General maintenance .....	9-2
Outside the vehicle .....	9-2
Inside the vehicle .....	9-3
Under the hood and vehicle.....	9-4

Periodic maintenance schedules .....	9-5
Schedule one .....	9-5
Schedule two.....	9-5
Explanation of maintenance items.....	9-10



## GENERAL MAINTENANCE

Your new NISSAN has been designed to have minimum maintenance requirements with longer service intervals to save you both time and money. However, some day-to-day and regular maintenance is essential to maintain your NISSAN's good mechanical condition, as well as its emission and engine performance.

It is the owner's responsibility to make sure the specified maintenance, as well as general maintenance, is performed.

As the vehicle owner, you are the only one who can ensure that your vehicle receives proper maintenance. You are a vital link in the maintenance chain.

### General maintenance

General maintenance includes those items which should be checked during normal day-to-day operation of the vehicle. They are essential if your vehicle is to continue to operate properly. It is your responsibility to perform these maintenance procedures regularly as prescribed.

These checks or inspections can be done by yourself, a qualified technician or, if you prefer, an authorized NISSAN dealer.

### 9-2 Maintenance

### Periodic maintenance

The maintenance items listed under "Periodic Maintenance" in this section must be serviced at regular intervals.

However, under severe driving conditions, additional or more frequent maintenance is required.

### Where to go for service

If maintenance service is required or your vehicle appears to malfunction, have the systems checked and tuned by an authorized NISSAN dealer.

NISSAN technicians are well-trained specialists who are kept up to date with the latest service information through technical bulletins, service tips, and in-dealership training programs. They are completely qualified to work on NISSAN vehicles **before** they work on your vehicle, rather than after they have worked on it.

You can be confident that an authorized NISSAN dealer's service department performs the best job to meet the maintenance requirements on your vehicle — in a reliable and economic way.

During the normal day-to-day operation of the vehicle, general maintenance should be performed regularly as prescribed in this section. If you detect any unusual sounds, vibrations or smells, be sure to check for the cause or have an authorized NISSAN dealer do it promptly. In addition, you should notify an authorized NISSAN dealer if you think repairs are required.

When performing any checks or maintenance work, closely observe the precautions in the "Do-it-yourself" section of this manual.

**Additional information on the following items with an "\*" can be found in the "Do-it-yourself" section of this manual.**

### OUTSIDE THE VEHICLE

The maintenance items listed here should be performed from time to time, unless otherwise specified.

**Tires\*** — Check the pressure with a gauge periodically when at a service station, including the spare, and adjust to the specified pressure if necessary. Check carefully for damage, cuts or excessive wear.

**Wheel nuts\*** — When checking the tires,

make sure no wheel nuts are missing, and check for any loose wheel nuts. Tighten if necessary.

**Tire rotation\*** — Tires should be rotated every 7,500 miles (12,000 km).

**Wheel alignment and balance** — If the vehicle should pull to either side while driving on a straight and level road, or if you detect uneven or abnormal tire wear, there may be a need for a wheel alignment.

If the steering wheel or seat vibrates at normal highway speeds, wheel balancing may be needed.

**Windshield wiper blades\*** — Check for cracks or wear if they do not wipe properly.

**Doors and hood** — Check that all doors and the hood operate properly. Also ensure that all latches lock securely. Lubricate hinges, latches, rollers and links if necessary. Make sure the secondary latch keeps the hood from opening when the primary latch is released.

When driving in areas using road salt or other corrosive materials, check lubrication frequently.

## INSIDE THE VEHICLE

The maintenance items listed here should be checked on a regular basis, such as when performing periodic maintenance, cleaning the vehicle, etc.

**Additional information on the following items with an “\*” is found in the “Do-it-yourself” section of this manual.**

**Lights\*** — Make sure the headlights, stop lights, tail lights, turn signal lights, and other lights are all operating properly and installed securely. Also check headlight aim.

**Warning lights and buzzers/chimes** — Make sure all warning lights and buzzers/chimes are operating properly.

**Windshield wiper and washer\*** — Check that the wipers and washer operate properly and that the wipers do not streak.

**Windshield defroster** — Check that the air comes out of the defroster outlets properly and in sufficient quantity when operating the heater or air conditioner.

**Steering wheel** — Check for changes in the steering conditions, such as excessive freeplay, hard steering or strange noises.

**Seats** — Check seat position controls such as seat adjusters, seatback recliner, etc. to ensure they operate smoothly and all latches lock securely in every position. Check that the head restraints move up and down smoothly and the locks hold securely in all latched positions. Check that the seat leg latches lock securely in every anchor position for the folding down rear seat and detachable rear seat (if so equipped).

**Seat belts** — Check that all parts of the seat belt system (e.g. buckles, anchors, adjusters and retractors) operate properly and smoothly, and are installed securely. Check the belt webbing for cuts, fraying, wear or damage.

**Accelerator pedal** — Check the pedal for smooth operation and make sure the pedal does not catch or require uneven effort. Keep the floor mat away from the pedal.

**Brakes** — Check that the brakes do not pull the vehicle to one side when applied.

**Brake pedal and booster\*** — Check the pedal for smooth operation and make sure it has the proper distance under it when depressed fully. Check the brake booster func-



tion. Be certain to keep the floor mat away from the pedal.

**Parking brake\*** — Check that the pedal is adjusted to specification and confirm that your vehicle is held securely on a fairly steep hill with only the parking brake applied.

**Automatic transmission “Park” mechanism** — On a fairly steep hill check that your vehicle is held securely with the selector lever in the P (Park) position without applying any brakes.

## UNDER THE HOOD AND VEHICLE

The maintenance items listed here should be checked periodically, for example, each time you check the engine oil or refuel.

**Additional information on the following items with an “\*” is found in the “Do-it-yourself section” of this manual.**

**Windshield washer fluid\*** — Check that there is adequate fluid in the reservoir.

**Engine coolant level\*** — Check the coolant level when the engine is cold.

**Radiator and hoses** — Check the front of

the radiator and clean off any dirt, insects, leaves, etc., that may have accumulated. Make sure the hoses have no cracks, deformation, rot, or loose connections.

**Brake fluid level\*** — Make sure the brake fluid level is between the MIN and MAX lines on the reservoir.

**Battery\*** — Check the fluid level in each cell. It should be between the MAX and MIN lines.

**Engine drive belts\*** — Make sure the drive belts are not frayed, worn, cracked or oily.

**Engine oil level\*** — Check the level after parking the vehicle on a level surface with the engine off. Wait a few minutes for the oil to drain back into the oil pan.

**Power steering fluid level\* and lines** — Check the level when the fluid is cold with the engine off. Check the lines for proper attachment, leaks, cracks, etc.

**Automatic transmission fluid level\*** — Check the level after putting the selector lever in P (Park) with the engine idling at operating temperature.

**Exhaust system** — Make sure there are no cracks, holes, loose joints or supports. If the

sound of the exhaust seems unusual or there is a smell of exhaust fumes, immediately have the exhaust system inspected by an authorized NISSAN dealer. See the carbon monoxide warning in the “Starting and driving” section of this manual.

**Underbody** — The underbody is frequently exposed to corrosive substances such as those used on icy roads or to control dust. It is very important to remove these substances from the underbody, otherwise rust may form on the floor pan, frame, fuel lines and exhaust system. At the end of winter, the underbody should be thoroughly flushed with plain water, in those areas where mud and dirt may have accumulated. See the “Appearance and care” section of this manual.

**Fluid leaks** — Check under the vehicle for fuel, oil, water or other fluid leaks after the vehicle has been parked for a while. Water dripping from the air conditioner after use is normal. If you should notice any leaks or if gasoline fumes are evident, check for the cause and have it corrected immediately by an authorized NISSAN dealer.

## PERIODIC MAINTENANCE SCHEDULES

To ensure smooth, trouble-free, safe and economical driving, NISSAN provides two periodic maintenance schedules that may be used, depending upon the conditions in which you usually drive. These schedules contain both distance and time intervals, up to 60,000 miles (96,000 km)/48 months. For most people, the odometer reading indicates when service is needed. However, if you drive very little, your vehicle should be serviced at the regular time intervals shown in the schedules. **After 60,000 miles (96,000 km)/48 months, continue periodic maintenance at the same mileage/time intervals.**

### SCHEDULE ONE

Follow Periodic Maintenance Schedule One if your driving habits frequently include one or more of the following driving conditions:

- **Repeated short trips of less than 5 miles (8 km).**
- **Repeated short trips of less than 10 miles (16 km) with outside temperatures below freezing.**
- **Operating the vehicle in hot weather during stop-and-go “rush hour” traffic.**

- **Extensive idling and/or low speed driving for long distances, such as police, taxi or door-to-door delivery use.**
- **Driving in dusty conditions.**
- **Driving on rough, muddy, or salt spread roads.**
- **Towing a trailer, using a camper or a car-top carrier.**

### SCHEDULE TWO

Follow Periodic Maintenance Schedule Two if none of the driving conditions shown in Schedule One apply to your driving habits.

## Schedule One

Abbreviations: R = Replace I = Inspect. Correct or replace if necessary. [ ]: At the mileage intervals only

MAINTENANCE OPERATION		MAINTENANCE INTERVAL															
Perform at number of miles, kilometers or months, whichever comes first.	Miles × 1,000 (km × 1,000) Months	3.75 (6)	7.5 (12)	11.25 (18)	15 (24)	18.75 (30)	22.5 (36)	26.25 (42)	30 (48)	33.75 (54)	37.5 (60)	41.25 (66)	45 (72)	48.75 (78)	52.5 (84)	56.25 (90)	60 (96)
<b>Emission control system maintenance</b>																	
Drive belts	See NOTE (1).															I*	
Air cleaner filter	See NOTE (2).															[R]	
EVAP vapor lines																I*	
Fuel lines																I*	
Fuel filter	See NOTE (3)*.																
Engine coolant		Replace every 30,000 miles (48,000 km) or 36 months.*															
Engine oil		R	R	R	R	R	R	R	R	R	R	R	R	R	R	R	R
Engine oil filter		R	R	R	R	R	R	R	R	R	R	R	R	R	R	R	R
Spark plugs (Use PLATINUM-TIPPED type)		Replace every 105,000 miles (168,000 km).															
Timing belt		Replace every 105,000 miles (168,000 km).															

- NOTE:** (1) After 60,000 miles (96,000 km) or 48 months, inspect every 15,000 miles (24,000 km) or 12 months.  
 (2) If operating mainly in dusty conditions, more frequent maintenance may be required.  
 (3) If vehicle is operated under extremely adverse weather conditions or in areas where ambient temperatures are either extremely low or extremely high, the filters might become clogged. In such an event, replace them immediately.  
 \* Maintenance items and intervals with an “\*” are recommended by NISSAN for reliable vehicle operation. The owner need not perform such maintenance in order to maintain the emission warranty or manufacturer recall liability. Other maintenance items and intervals are required.

Abbreviations: R = Replace I = Inspect. Correct or replace if necessary.

MAINTENANCE OPERATION		MAINTENANCE INTERVAL							
Perform at number of miles, kilometers or months, whichever comes first.	Miles × 1,000	7.5	15	22.5	30	37.5	45	52.5	60
	(km × 1,000)	(12)	(24)	(36)	(48)	(60)	(72)	(84)	(96)
	Months	6	12	18	24	30	36	42	48
<b>Chassis and body maintenance</b>									
Brake lines & cables			I		I		I		I
Brake pads, rotors, drums & linings			I	I	I	I	I	I	I
Automatic transmission fluid		See NOTE (1).	I		I		I		I
Steering gear & linkage, axle & suspension parts			I	I	I	I	I	I	I
Exhaust system			I	I	I	I	I	I	I
Drive shaft boots			I	I	I	I	I	I	I
Cabin air filter (if so equipped)		See NOTE (3).		R		R		R	
Supplemental air bag system		See NOTE (2).							

**NOTE: (1) If towing a trailer, using a camper or a car-top carrier, or driving on rough or muddy roads, change (not just inspect) fluid at every 30,000 miles (48,000 km) or 24 months.**

**(2) Inspect the supplemental air bag system 10 years after the date of manufacture noted on the F.M.V.S.S. certification label.**

**(3) If operating mainly in dusty conditions, more frequent maintenance may be required.**

## Schedule Two

Abbreviations: R = Replace I = Inspect. Correct or replace if necessary.

[ ]: At the mileage intervals only

MAINTENANCE OPERATION	MAINTENANCE INTERVAL								
	Miles × 1,000 (km × 1,000)	7.5 (12)	15 (24)	22.5 (36)	30 (48)	37.5 (60)	45 (72)	52.5 (84)	60 (96)
Perform at number of miles, kilometers or months, whichever comes first.	Months	6	12	18	24	30	36	42	48
<b>Emission control system maintenance</b>									
Drive belts	See NOTE (1).								I*
Air cleaner housing filter									[R]
EVAP vapor lines									I*
Fuel lines									I*
Fuel filter	See NOTE (2)*.								
Engine coolant	Replace every 30,000 miles (48,000 km) or 36 months.*								
Engine oil	R	R	R	R	R	R	R	R	R
Engine oil filter	R	R	R	R	R	R	R	R	R
Spark plugs (Use PLATINUM-TIPPED)	Replace every 105,000 miles (168,000 km).								
Timing belt	Replace every 105,000 miles (168,000 km).								

**NOTE: (1) After 60,000 miles (96,000 km) or 48 months, inspect every 15,000 miles (24,000 km) or 12 months.**

**(2) If vehicle is operated under extremely adverse weather conditions or in areas where ambient temperatures are either extremely low or extremely high, the filters might become clogged. In such an event, replace them immediately.**

\* Maintenance items and intervals with an “\*” are recommended by NISSAN for reliable vehicle operation. The owner need not perform such maintenance in order to maintain the emission warranty or manufacturer recall liability. Other maintenance items and intervals are required.

Abbreviations: R = Replace I = Inspect. Correct or replace if necessary.

MAINTENANCE OPERATION		MAINTENANCE INTERVAL								
Perform at number of miles, kilometers or months, whichever comes first.	Miles × 1,000 (km × 1,000) Months	7.5 (12) 6	15 (24) 12	22.5 (36) 18	30 (48) 24	37.5 (60) 30	45 (72) 36	52.5 (84) 42	60 (96) 48	
<b>Chassis and body maintenance</b>										
Brake lines & cables			I			I		I		I
Brake pads, rotors, drums & linings			I			I		I		I
Automatic transmission fluid			I			I		I		I
Steering gear & linkage, axle & suspension parts						I				I
Exhaust system		See NOTE (1).				I				I
Drive shaft boots			I			I		I		I
Cabin air filter (if so equipped)		See NOTE (3).	R			R		R		R
Supplemental air bag system		See NOTE (2).								

**NOTE: (1) After 60,000 miles (96,000 km) or 48 months, inspect every 15,000 miles (24,000 km) or 12 months.**

**(2) Inspect the supplemental air bag system 10 years after the date of manufacture as noted on the F.M.V.S.S. certification label.**

**(3) If operating mainly in dusty conditions, more frequent maintenance may be required.**

## EXPLANATION OF MAINTENANCE ITEMS

**Additional information on the following items with an “\*” is found in the “Do-it-yourself operations” section of this manual.**

### Emission control system maintenance

**Drive belts\*** — Check drive belts for wear, fraying or cracking and also for proper tension. Replace any damaged drive belts.

**Engine air cleaner filter** — Under normal driving conditions, the air cleaner filter should be replaced in accordance with the maintenance schedule. However, driving the vehicle in dusty areas may cause rapid clogging of the element. Consequently, the element may have to be replaced more frequently.

**Evap vapor lines** — Check vapor lines and connections for leaks, looseness or deterioration. If leaks are found, replace them.

**Fuel lines** — Check the fuel hoses, piping and connections for leaks, looseness or deterioration. Replace any damaged parts.

**Fuel filter** — If the vehicle is operated under extremely adverse weather conditions or in areas where ambient temperatures are either extremely low or extremely high, the

filter might become clogged. In such an event, replace the filter immediately.

**Engine coolant\*** — Changing engine coolant can be performed by your NISSAN dealer or procedures can be found in the Service Manual. Improper air relief after changing coolant can result in reduced heater performance and overheating.

**Engine oil & oil filter\*** — Under normal driving conditions, the engine oil and oil filter should be replaced in accordance with the maintenance schedule. However, under severe driving conditions, they may have to be replaced more frequently.

**Spark plugs\*** — Replace with new plugs having the correct heat range.

**Timing belt** — Replace the timing belt for driving the camshaft.

### Chassis and body maintenance

**Brake lines & cables** — Check the brake lines and hoses (including brake booster vacuum hoses, connections & check valve) and parking brake cables for proper attachment, leaks, cracks, chafing, abrasion, deterioration, etc.

**Brake pads, rotors, drums & linings** — Check these and the other brake components for wear, deterioration and leaks. Under severe driving conditions, they may have to be inspected more frequently.

**Automatic transmission fluid\*** — Check the fluid level and visually inspect for signs of leakage.

Under severe driving conditions, the fluid should be replaced at the specified interval.

**Steering gear & linkage, axle & suspension parts, and drive shaft boots** — Check for damage, looseness and leakage of oil or grease. Under severe driving conditions, they may have to be inspected more frequently.

**Exhaust system** — Visually check the exhaust pipes, muffler, and hangers for proper attachment, leaks, cracks, chafing, abrasion, deterioration, etc. Under severe driving conditions, inspection should be performed more frequently.

**Supplemental air bag system** — Check the supplemental air bag system components for proper attachment, damage, deformities, cracks, rust, etc. Work around and on the supplemental air bag system should be done by an authorized NISSAN dealer.

**Cabin air filter** — Under normal driving conditions, the cabin air filter should be replaced in accordance with the maintenance schedule. However, driving the vehicle in dusty areas may cause rapid clogging of the element. Consequently, the element may have to be replaced more frequently.



**MEMO**

9-12 **Maintenance**

# 10 Technical and consumer information

Capacities and recommended fuel/lubricants .....	10-2	Engine serial number .....	10-10
Fuel recommendation.....	10-2	F.M.V.S.S. certification label .....	10-10
Engine oil and oil filter recommendation.....	10-4	Emission control information label .....	10-10
Recommended SAE viscosity number.....	10-6	Tire placard .....	10-11
Air conditioner system refrigerant and lubricant recommendations .....	10-6	Air conditioner specification label.....	10-11
Engine .....	10-7	Installing the license plate.....	10-11
Wheel/tire size.....	10-8	Vehicle loading information .....	10-12
Dimensions and weights .....	10-8	Trailer towing.....	10-13
Registering your vehicle in another country .....	10-9	Uniform tire quality grading.....	10-18
Vehicle identification .....	10-9	Emission control system warranty .....	10-19
Vehicle identification number (VIN) plate.....	10-9	Reporting safety defects (US only) .....	10-19
Vehicle identification number (chassis number).....	10-9	Readiness for inspection/maintenance (I/M) test (US only) .....	10-20



## CAPACITIES AND RECOMMENDED FUEL/LUBRICANTS

The following are approximate capacities. The actual refill capacities may be a little different. When refilling, follow the procedure instructed in the “Do-it-yourself” section to determine the proper refill capacity.

Fuel	Capacity (Approximate)			Recommended Fluids & Lubricants
	US measure	Imp measure	Liter	
Engine oil (7) Drain and refill	20 gal	16-5/8 gal	75.7	Unleaded gasoline with an octane rating of at least 87 AKI (RON 91)(1)
With oil filter change	4-1/4 qt	3-1/2 qt	4.0	<ul style="list-style-type: none"> <li>• API Certification Mark (2) (3)</li> <li>• API grade SG/SH, Energy Conserving II or API grade SJ, Energy Conserving (2) (3)</li> <li>• ILSAC grade GF-II (2) (3)</li> </ul>
Without oil filter change	3-7/8 qt	3-1/8 qt	3.6	
Cooling system				
With reservoir tank	11-1/4 qt	9-3/8 qt	10.6	50% Genuine NISSAN Anti-freeze Coolant or equivalent
Reservoir	1-1/8 qt	1 qt	1.1	50% Demineralized water or Distilled water
Automatic transaxle fluid	10 qt	8-1/4 qt	9.4	NISSAN matic ‘D’ (Continental U.S. and Alaska) or Genuine Nissan Automatic Transmission Fluid (Canada).(4)
Power steering fluid	Refill to the proper oil level according to the instructions in the “Do-it-yourself” section.			Type F automatic transmission fluid or equivalent
Brake fluid				Genuine NISSAN Brake Fluid(5) or equivalent DOT 3 (US FMVSS No. 116)
Multi-purpose grease	—	—	—	NLGI No. 2 (Lithium complex)
Air conditioning system refrigerant	—	—	—	HFC-134a (R-134a)(6)

(1): For further details, see “Fuel recommendation”.

(2): For further detail, see “Engine oil and oil filter recommendations.”

(3): For further details, see “Recommended SAE engine oil viscosity”.

(4): Dexron® III/Mercon® or equivalent may also be used. Outside the Continental United States and Alaska contact a NISSAN dealership for more information regarding suitable fluids, including recommended brand(s) of Dexron® III/Mercon® Automatic Transmission Fluid.

(5): Available in mainland U.S.A. through an authorized NISSAN dealer.

(6): For further details, see “Air conditioner specification label”.

(7): For further details, see “Changing engine oil.”

### 10-2 Technical and consumer information

## FUEL RECOMMENDATION

Your vehicle is designed to operate on unleaded gasoline with an octane rating of at least 87 AKI (Anti-Knock Index) number (Research octane number 91).



### CAUTION

- Using a fuel other than that specified could adversely affect the emission control devices and systems, and could also affect warranty coverage.
- Under no circumstances should a leaded gasoline be used, since this will damage the three way catalyst.

## Reformulated gasoline

Some fuel suppliers are now producing reformulated gasolines. These gasolines are specially designed to reduce vehicle emissions. NISSAN supports efforts towards cleaner air and suggests that you use reformulated gasoline when available.

## Gasoline containing oxygenates

Some fuel suppliers sell gasoline containing oxygenates such as ethanol, MTBE and methanol with or without advertising their presence. NISSAN does not recommend the use of fuels of which the oxygenate content and the fuel compatibility for your NISSAN cannot be readily determined. If in doubt, ask your service station manager.

If you use oxygenate-blend gasoline, please take the following precautions as the usage of such fuels may cause vehicle performance problems and/or fuel system damage.

- **The fuel should be unleaded and have an octane rating no lower than that recommended for unleaded gasoline.**
- **If an oxygenate-blend, excepting a methanol blend, is used, it should contain no more than 10% oxygenate. (MTBE may, however, be added up to 15%.)**
- **If a methanol blend is used, it should contain no more than 5% methanol (methyl alcohol, wood alcohol). It should also contain a suitable amount of appropriate cosolvents and corro-**

**sion inhibitors. If not properly formulated with appropriate cosolvents and corrosion inhibitors, such methanol blends may cause fuel system damage and/or vehicle performance problems. At this time, sufficient data is not available to ensure that all methanol blends are suitable for use in NISSAN vehicles.**

If any undesirable driveability problems such as engine stalling and difficult hot-starting are experienced after using oxygenate-blend fuels, immediately change to a non-oxygenate fuel or a fuel with a low blend of MTBE.

**Take care not to spill gasoline during refueling. Gasoline containing oxygenates can cause paint damage.**

### Aftermarket fuel additives

NISSAN does not recommend the use of any fuel additives (i.e.: fuel injector cleaner, octane booster, intake valve deposit removers, etc.) which are sold commercially. Many of these additives intended for gum, varnish or deposit removal may contain active solvents or similar ingredients that

can be harmful to the fuel system and engine.

### Octane rating tips

In most parts of North America, you should use unleaded gasoline with an octane rating of at least 87 AKI (Anti-Knock Index) number. However, you may use unleaded gasoline with an octane rating as low as 85 AKI (Anti-Knock Index) in high altitude areas (over 4,000 ft [1,219 m]) such as: Colorado, Montana, New Mexico, Utah, Wyoming, northeastern Nevada, southern Idaho, western South Dakota, western Nebraska, and the part of Texas which is directly south of New Mexico.

**Using unleaded gasoline with an octane rating lower than stated above can cause persistent, heavy “spark knock.” (“Spark knock” is a metallic rapping noise.) If severe, this can lead to engine damage. If you detect a persistent heavy spark knock even when using gasoline of the stated octane rating, or if you hear steady spark knock while holding a steady speed on level roads, have an authorized NISSAN dealer correct the condition. Failure to correct the condition is misuse**

of the vehicle, for which NISSAN is not responsible.

Incorrect ignition timing may result in spark knock, after-run, and/or overheating, which may cause excessive fuel consumption or engine damage. If any of the above symptoms are encountered, have your vehicle checked at an authorized NISSAN dealer or other competent service facility.

However, now and then you may notice light spark knock for a short time while accelerating or driving up hills. This is no cause for concern, because you get the greatest fuel benefit when there is light spark knock for a short time under heavy engine load.

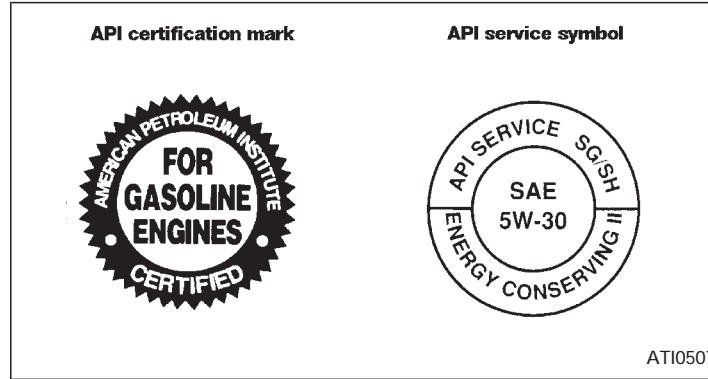

## ENGINE OIL AND OIL FILTER RECOMMENDATION

### Selecting the correct oil

It is essential to choose engine oil with the correct quality and viscosity to ensure satisfactory engine life and performance. NISSAN recommends the use of a low friction oil (energy conserving oil) in order to improve fuel economy and conserve energy. Oils which do not have the specified quality label should not be used as they could cause engine damage.

Only those engine oils with the American Petroleum Institute (API) CERTIFICATION MARK on the front of the container should be used. This type of oil supersedes the existing API SG, SH, or SJ and Energy Conserving II categories.

If you cannot find engine oil with the API CERTIFICATION MARK, use an API grade SG/SH, Energy Conserving II or API grade SJ, Energy Conserving oil. An oil with a single designation SG or SH, or in combination with other categories (for example, SG/CC or SG/CD) may also be used if one

with the API CERTIFICATION MARK cannot be found. An ILSAC grade GF-II oil can also be used.

Mineral based or synthetic type oils may be used in your NISSAN vehicle. These oils must, however, meet the API quality and SAE viscosity ratings specified for your vehicle. Do not mix mineral based and synthetic type oils in the engine.

### Oil additives

NISSAN does not recommend the use of oil additives. The use of an oil additive is not necessary when the proper oil type is used and maintenance intervals are followed.

Oil which may contain foreign matter or has been previously used should not be used.

### Oil viscosity

The engine oil viscosity or thickness changes with temperature. Because of this, it is important to select the engine oil viscosity based on the temperatures at which the vehicle will be operated before the next oil change. The chart "Recommended SAE viscosity number" shows the recommended oil viscosities for the expected ambient temperatures. Choosing an oil viscosity other

than that recommended could cause serious engine damage.

### Selecting the correct oil filter

Your new NISSAN vehicle is equipped with a high- quality genuine NISSAN oil filter. When replacing, use a genuine NISSAN oil filter or its equivalent for the reason described in "Change intervals".

### Change intervals

The oil and oil filter change intervals for your engine are based on the use of the specified quality oils and filters. Oil and filter other than the specified quality, or oil and filter change intervals longer than recommended could reduce engine life. Damage to the engine caused by improper maintenance or use of incorrect oil and filter quality and/or viscosity is not covered by the new NISSAN vehicle warranties.

Your engine was filled with a high quality engine oil when it was built. You do not have to change the oil before the first recommended change interval. Oil and filter change intervals depend upon how you use your vehicle. Operation under the following conditions may require more frequent oil and filter changes:

- repeated short distance driving at cold outside temperatures,
- driving in dusty conditions,
- extensive idling,
- towing a trailer.

## RECOMMENDED SAE VISCOSITY NUMBER

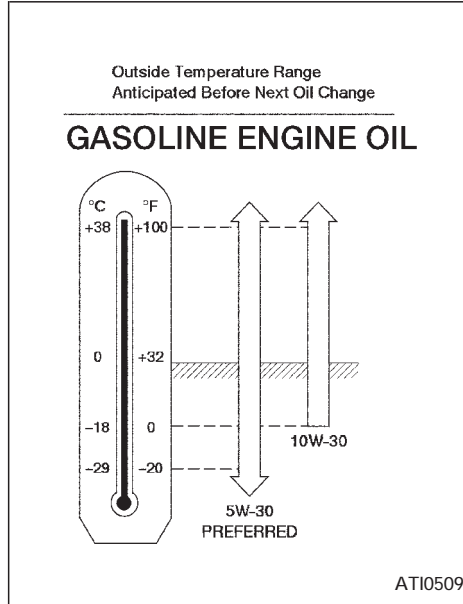

- SAE 5W-30 viscosity oil is preferred for all temperatures. SAE 10W-30 viscosity oil may be used if the ambient temperature is above 0°F (-18°C).

10-6 Technical and consumer information

## AIR CONDITIONER SYSTEM REFRIGERANT AND LUBRICANT RECOMMENDATIONS

The air conditioning system in this NISSAN vehicle must be charged with the refrigerant HFC-134a (R-134a) and the lubricant, NISSAN type “PAG F” or the exact equivalents.

### ⚠ CAUTION

Use of any other refrigerant or lubricant will cause severe damage and you will need to replace your vehicle’s entire air conditioning system.

The refrigerant HFC-134a (R-134a) in your NISSAN vehicle does not harm the earth’s ozone layer. Although this refrigerant does not affect the earth’s atmosphere, certain government regulations require the recovery and recycling of any refrigerant during automotive air conditioning system service. An authorized NISSAN dealer has the trained technicians and equipment needed to recover and recycle your air conditioning system refrigerant.

Contact an authorized NISSAN dealer when servicing your air conditioning system.

# ENGINE

Model	VG33E	
Type	Gasoline, 4-cycle	
Cylinder arrangement	6-cylinder, V slanted at 60°	
Bore × Stroke	in (mm)	3.602 × 3.274 (91.5 × 83.0)
Displacement	cu in (cm <sup>3</sup> )	199.84 (3,275)
Firing order	1,2,3,4,5,6* (See illustration below)	
Idle speed	rpm	
Ignition timing degree (B.T.D.C.) at idle speed	degree/rpm	See the "Important Vehicle Information" label on the underside of the hood.
CO percentage at idle speed [No air]	%	
Spark plug		
Hot	PFR4G-11	
Standard	PFR5G-11	
Cold	PFR6G-11	
Camshaft operation	Timing belt** (See note below)	
Drive belts [Width × Length]	in (mm)	
Generator belt	0.7008 × 33.66 (17.80 × 855)	
Air conditioner compressor	0.5606 × 46.65 (14.24 × 1,185)	
Power steering pump	0.5606 × 40.74 (14.24 × 1,035)	

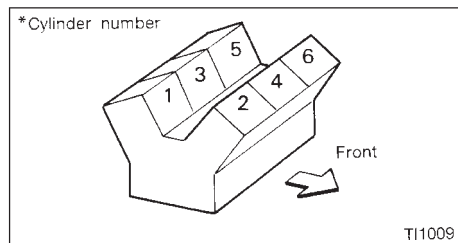

\*\*NOTE: Periodic maintenance is necessary. Refer to the appropriate periodic maintenance schedule in Chapter 8.

**The spark ignition system of this vehicle meets all requirements of the Canadian Interference-Causing Equipment Regulations.**



## WHEEL/TIRE SIZE

Road wheel	Steel	5.5JJ × 15	
	Aluminum	6JJ × 15 6.5JJ × 15 6JJ × 16	
	Offset	in (mm)	1.77 (45)
Tire size	Conventional	P215/70R15	97 S
	Painted cast aluminum	P215/70R15	97 S
	Machined cast aluminum	P225/60R16	97 T
	Spare	T125/90D16 P215/70R15	97 S

## DIMENSIONS AND WEIGHTS

Overall length	in (mm)	194.8 (4,949)
Overall width	in (mm)	74.9 (1,903)
Overall height	in (mm)	67.3 (1,710)
Front tread	in (mm)	63.4 (1,610)
Rear tread	in (mm)	63.4 (1,610)
Wheelbase	in (mm)	112.2 (2,850)
Gross vehicle weight rating	lb (kg)	
Gross axle weight rating	See the "F.M.V.S.S. certification label" on the left center pillar.	
Front	lb (kg)	
Rear	lb (kg)	

## REGISTERING YOUR VEHICLE IN ANOTHER COUNTRY

**When planning to travel in another country**, you should first find out if the fuel available is suitable for your vehicle's engine.

Using fuel with an octane/cetane rating that is too low may cause engine damage. All gasoline vehicles must be operated with unleaded gasoline. Therefore, avoid taking your vehicle to areas where appropriate fuel is not available.

**When transferring the registration of your vehicle to another country, state, province or district**, it may be necessary to modify the vehicle to meet local laws and regulations.

The laws and regulations for motor vehicle emission control and safety standards vary according to the country, state, province or district. Therefore, vehicle specifications may differ.

**When any vehicle is to be taken into another country, state, province or district and registered, its modifications, transportation, and registration are the responsibility of the user. NISSAN is not responsible for any inconvenience that may result.**

## VEHICLE IDENTIFICATION

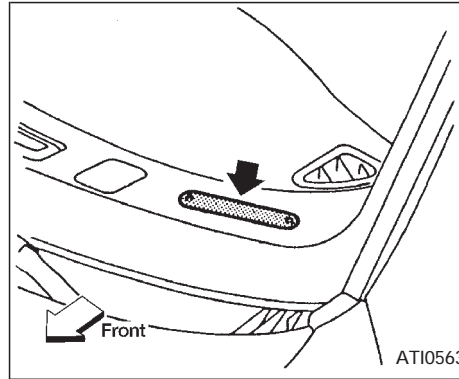

### VEHICLE IDENTIFICATION NUMBER (VIN) PLATE

The vehicle identification number plate is attached to the upper portion of the dashboard on the driver's side. This number is the identification for your vehicle and is used in the vehicle registration.

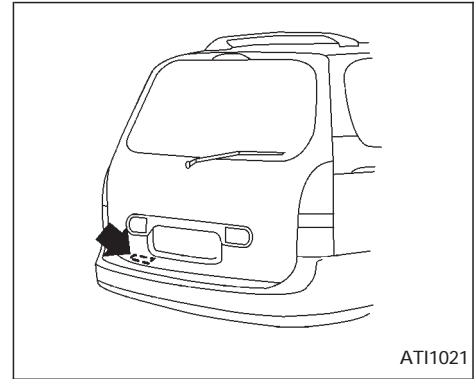

### VEHICLE IDENTIFICATION NUMBER (chassis number)

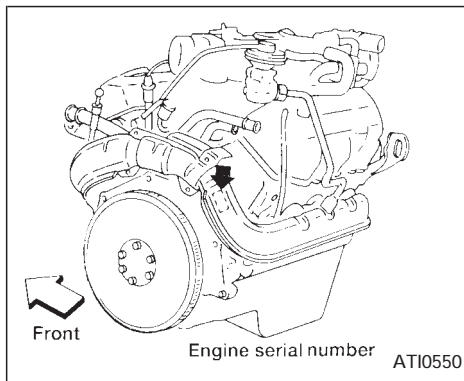

### ENGINE SERIAL NUMBER

The number is stamped on the engine as shown.

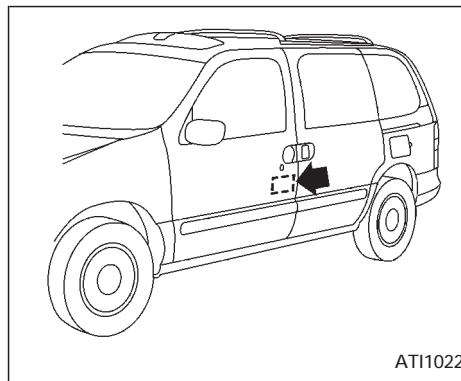

### F.M.V.S.S. CERTIFICATION LABEL

The F.M.V.S.S. certification label is affixed as shown. This label contains valuable vehicle information, such as: Gross Vehicle Weight Rating (GVWR), Gross Axle Weight Rating (GAWR), month and year of manufacture, Vehicle Identification Number (VIN), etc. Review it carefully.

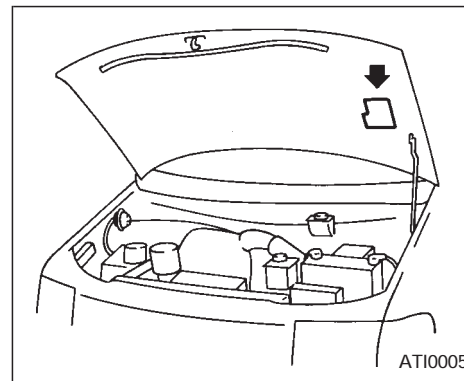

### EMISSION CONTROL INFORMATION LABEL

The emission control information label is attached as shown.

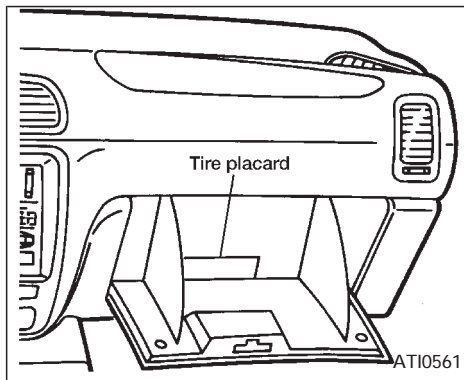

### TIRE PLACARD

The cold tire pressure is shown on the tire placard affixed to the inside of the glove box.

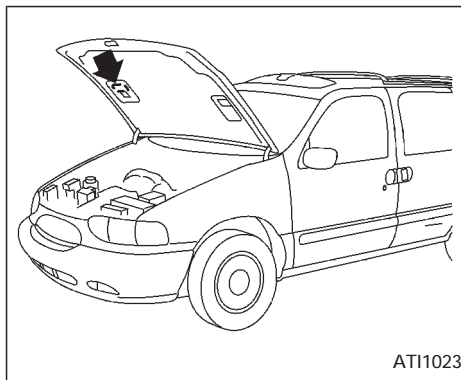

### AIR CONDITIONER SPECIFICATION LABEL

The air conditioner specification label is attached as shown.

## INSTALLING THE LICENSE PLATE

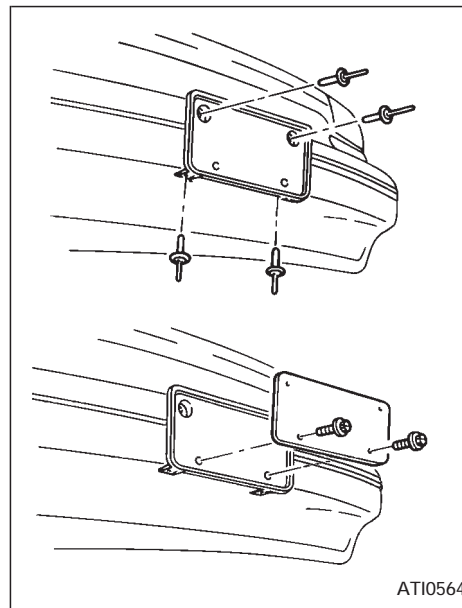

Have your front license plate installed by your NISSAN dealer.

# VEHICLE LOADING INFORMATION

## WARNING

- **It is extremely dangerous to ride in a cargo area inside of a vehicle. In a collision, people riding in these areas are more likely to be seriously injured or killed.**
- **Do not allow people to ride in any area of your vehicle that is not equipped with seats and seat belts.**
- **Be sure everyone in your vehicle is in a seat and using a seat belt properly.**

## Terms

It is important to familiarize yourself with the following terms before loading your vehicle:

- **Curb Weight** (actual weight of your vehicle) - vehicle weight including: standard and optional equipment, fluids, emergency tools, and spare tire assembly. This weight **does not** include passengers and cargo.
- **GVW** (Gross Vehicle Weight) - curb weight plus the combined weight of passengers and cargo.
- **GVWR** (Gross Vehicle Weight Rating) - maximum total weight (load) limit specified for the vehicle.

## 10-12 Technical and consumer information

- **GAWR** (Gross Axle Weight Rating) - maximum weight (load) limit specified for the front or rear axle.
- **Gross combined weight** - GVW plus the total weight of the trailer and all its cargo.

## Determining Vehicle Load Capacity

The load capacity of this vehicle is determined by weight, not by available cargo space. For example, a luggage rack, bike carrier, cartop carrier or similar equipment does not increase load carrying capacity of your vehicle.

To determine vehicle load capacity:

Vehicle weight can be determined by using a commercial-grade scale, found at places such as a truck stop, gravel quarry, grain elevator, or a scrap metal recycling facility.

- 1) Determine the curb weight of your vehicle.
- 2) Compare the curb weight amount to the GVWR specified for your vehicle to determine how much more weight your vehicle can carry.
- 3) After loading (cargo & passengers), reweigh your vehicle to determine if either GVWR or GAWR for your vehicle is

exceeded. If GVWR is exceeded, remove cargo as necessary. If either the front or rear GAWR is exceeded, shift the load or remove cargo as necessary.

## Loading Tips

- The GVW must not exceed GVWR or GAWR specified on the F.M.V.S.S. Certification Label.
- Do not load the front and rear axle to the GAWR. Doing so will exceed the GVWR.

## WARNING

- **Properly secure all cargo to help prevent it from sliding or shifting. Do not place cargo higher than the seat-backs. In a sudden stop or collision, unsecured cargo could cause personal injury.**
- **Do not load your vehicle any heavier than the GVWR or the maximum front and rear GAWRs. If you do, parts on your vehicle can break, or it can change the way your vehicle handles. This could result in loss of control and cause personal injury.**

## TRAILER TOWING

- **Overloading can shorten the life of your vehicle. Failures caused by overloading are not covered by your warranty.**

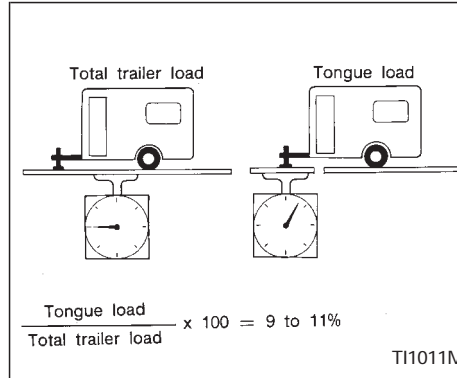

Your new vehicle was designed to be used primarily to carry passengers and cargo. Remember that towing a trailer places additional loads on your vehicle's engine, drive train, steering, braking and other systems.

A NISSAN Trailer Towing Guide (U.S. only) contains information on your vehicle's trailer towing ability and the special equipment required, and may be obtained from an authorized NISSAN dealer.

Do not tow a trailer if your vehicle is a cargo van model.

### Maximum load limits

#### Maximum trailer loads

Never allow the total trailer load to exceed 3,500 lbs (1,588 kg). The total trailer load equals trailer weight plus its cargo weight. Towing loads greater than 3,500 lbs (1,588 kg) or using improper towing equipment could adversely affect vehicle handling, braking and performance.

- All towing above 1,000 lbs (454 kg) requires the use of trailer brakes.
- NISSAN recommends the use of a tandem axle trailer whenever towing above 3,000 lbs (1,361 kg).
- A sway control device is recommended for all towing above 2,000 lbs (907 kg). Sway control devices are not offered by NISSAN. See a professional trailer/hitch outlet for a properly designed sway control device for your trailer.

The Gross Combined Weight should not exceed 8,000 lbs (3,628 kg). The Gross Combined Weight is the total weight of the tow vehicle with all occupants, cargo and fuel tanks, PLUS the total weight of the trailer and all its cargo. This weight should

be properly distributed. For more information regarding vehicle and trailer loading, refer to The NISSAN Towing Guide, available from an authorized NISSAN dealer.

**⚠ WARNING**

**Vehicle damage and/or personal injury resulting from improper towing procedures is not covered by NISSAN warranties. Information on trailer towing and required towing equipment should be obtained from dealers who specialize in providing trailers or other towing equipment.**

**Tongue load:**

Keep the tongue load between 9 and 11% of the total trailer load. If the tongue load becomes excessive, rearrange cargo to allow for proper tongue load.

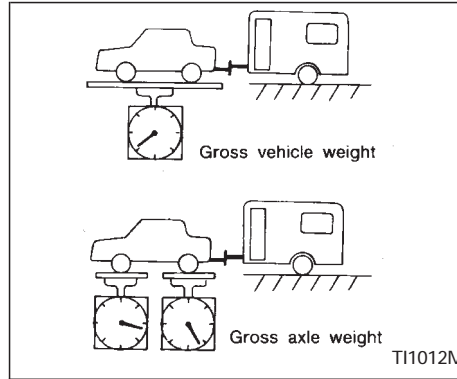

Maximum gross vehicle weight/maximum gross axle weight

The gross vehicle weight of the towing vehicle must not exceed the gross vehicle weight rating (GVWR) shown on the F.M.V.S.S. certification label. The gross vehicle weight equals the combined weight of the unloaded vehicle, passengers, luggage, hitch, trailer tongue load and any other optional equipment. In addition, front or rear gross axle weight must not exceed the gross axle weight rating (GAWR) shown on the F.M.V.S.S. certification label.

**TOWING LOAD/SPECIFICATION CHART**

UNIT: lb (kg)

MAXIMUM TOWING LOAD	3,500 (1,588)
MAXIMUM TONGUE LOAD	350 (159)

**Trailer hitch**

Choose a proper hitch for your vehicle and trailer. A genuine NISSAN trailer hitch is available from your NISSAN dealer (Canada only). Make sure the trailer hitch is securely attached to the vehicle to help avoid personal injury or property damage due to sway caused by crosswinds, rough road surfaces or passing trucks.

**⚠ CAUTION**

- **Do not use axle-mounted hitches.**
- **The hitch should not be attached to or affect the operation of the impact-absorbing bumper.**
- **Do not modify the vehicle exhaust system, brake system, etc. when the hitch is installed.**

- **To reduce the possibility of additional damage if your vehicle is struck from the rear, where practical remove the hitch when not in use. Remove the receiver when not in use. After the hitch is removed, seal the bolt holes to prevent exhaust fumes, water or dust from entering the passenger compartment.**
- **Regularly check that all hitch mounting bolts are securely mounted.**

## Tire pressures

- When towing a trailer, inflate the vehicle tires to the recommended cold tire pressure indicated on the tire placard (located on the inside of the glove box lid).
- Trailer tire condition, size, load rating and proper inflation pressure should be in accordance with the trailer and tire manufacturer's specifications.

## Safety chain

Always use suitable safety chains between your vehicle and the trailer. Safety chains should be crossed and should be attached to the hitch, not to the vehicle bumper or

axle. Be sure to leave enough slack in the chains to permit turning corners.

## Trailer lights

Trailer lights should comply with Federal and/or local regulations. When wiring the vehicle for towing, connect the stop and tail light pickup into the vehicle electrical circuit.

Class I Trailer Tow electrical wiring provides two circuits (right and left hand) to operate trailer stop/turn tail lamps. Each individual stop/turn circuit will operate only one combination stop/turn light bulb (#1157, 3157, 2357, or 3357) on the trailer. Never add more than one trailer light bulb to one circuit.



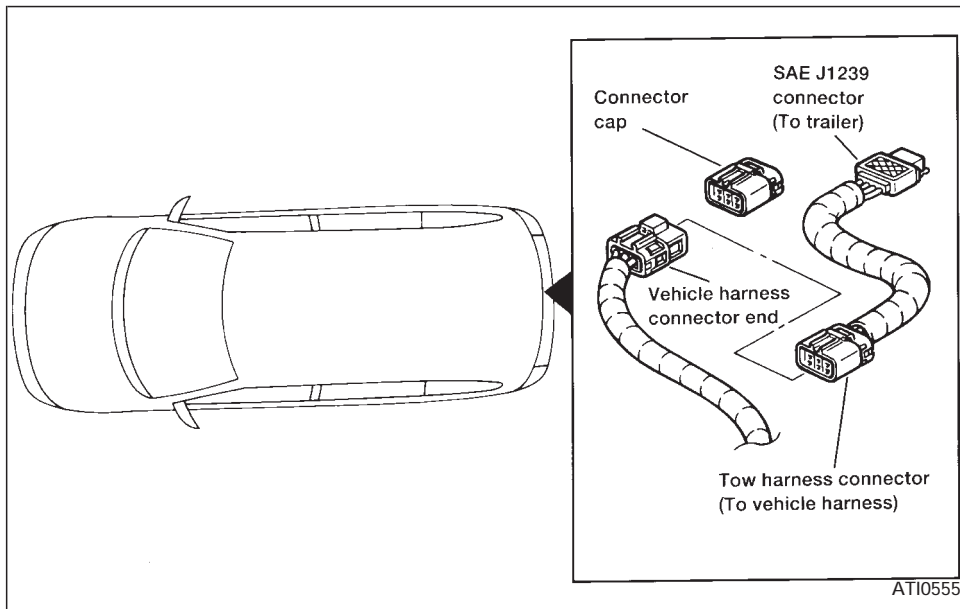

### Trailer Tow Harness and Module (if so equipped)

The trailer tow module on your vehicle allows turn/stop lamp control of a trailer being towed by your NISSAN.

The trailer tow module includes:

- trailer tow module which draws power from the vehicle stop lamp fuse
- one subharness containing a SAE J1239 specified connector

To use the tow harness:

- 1) Remove the connector cap from the vehicle harness, located behind the rear bumper. Store the connector cap in vehicle glove box for reinstallation.
- 2) Connect the tow harness to the vehicle harness located behind the rear bumper.
- 3) Connect the tow harness connector (SAE J1239) to your trailer.
- 4) Confirm proper vehicle and trailer stop/turn lamp operation.
- 5) When towing is completed, disconnect the tow harness from the trailer and the vehicle. Store the tow harness in the glove box. Reinstall the connector cap to the vehicle harness.

If you need further assistance in wiring a trailer to your NISSAN, contact an authorized NISSAN dealer.

**Always confirm proper vehicle and trailer stop/turn lamp operation every time the trailer light circuits are connected for use.**

## Trailer brakes

If your trailer is equipped with a braking system, make sure it conforms to Federal and/or local regulations and it is properly installed.

### **WARNING**

**Never connect a trailer brake system directly to the vehicle brake system.**

## Pre-towing tips

- Be certain your vehicle maintains a level position when a loaded and/or unloaded trailer is hitched. Do not drive the vehicle if it has an abnormal nose-up or nose-down condition; check for improper tongue load, overload, worn suspension or other possible causes of either condition.
- Always secure items in the trailer to prevent load shift while driving.
- Be certain your rear view mirrors conform to all federal, state or local regulations. If not, install any mirrors required for towing before driving the vehicle.

## Trailer towing tips

In order to gain skill and an understanding of the vehicle's behavior, you should practice turning, stopping and backing up in an area which is free from traffic. Steering, stability, and braking performance are somewhat different than under normal driving conditions.

- Always secure items in the trailer to prevent load shift while driving.
- Avoid abrupt starts, acceleration or stops.
- Avoid sharp turns or lane changes.
- Always drive your vehicle at a moderate speed.
- Always block the wheels on both vehicle and trailer when parking. Parking on a slope is not recommended; however, if you must do so, first block the wheels and apply the parking brake, and then move the transmission shift selector lever into the P (Park) position. If you move the shift selector lever to the P (Park) position before blocking the wheels and applying the parking brake, transmission damage could occur.
- When going down a hill, shift into a lower

gear and use the engine braking effect. When ascending a long grade, downshift the transmission to a lower gear and reduce speed to reduce chances of engine overloading and/or overheating.

- If the engine coolant rises to an extremely high temperature when the air conditioning system is on, turn the air conditioner off. Coolant heat can be additionally vented by opening the windows, switching the fan control dial to high and setting the temperature control dial to the WARM position.
- Trailer towing requires more fuel than normal circumstances.
- Avoid towing a trailer for the first 500 miles (800 km) of the vehicle's life.
- Have your vehicle serviced more often than at intervals specified in the recommended Maintenance Schedule.
- When making a turn, your trailer wheels will be closer to the inside of the turn than your vehicle wheels. To compensate for this, make a larger than normal turning radius during the turn.
- Crosswinds and rough roads adversely

## UNIFORM TIRE QUALITY GRADING

affect vehicle/trailer handling, possibly causing vehicle sway. When being passed by larger vehicles, be prepared for possible changes in crosswinds that could affect vehicle handling. If swaying does occur, firmly grip the steering wheel, steer straight ahead, and immediately (but gradually) reduce vehicle speed. This combination helps to stabilize the vehicle. Never increase speed.

- Be careful when passing other vehicles. Passing while towing a trailer requires considerably more distance than normal passing. Remember the length of the trailer must also pass the other vehicle before you can safely change lanes.
- To maintain engine braking efficiency and electrical charging performance, do not use overdrive.
- Avoid holding the brake pedal down too long or too frequently. This could cause the brakes to overheat, resulting in reduced braking efficiency.

**When towing a trailer, change fluid in the transmission more frequently. For additional information see the “Maintenance” section earlier in this manual.**

Department of Transportation (DOT) Quality Grades: All passenger car tires must conform to Federal Safety Requirements in addition to these grades.

### Treadwear

Treadwear grade is a comparative rating based on tire wear rate when tested under controlled conditions on specified government test courses. For example, a tire graded 150 would wear one and a half (1-1/2) times as well on the government course as a tire graded 100. However, relative tire performance depends on actual driving conditions, and may vary significantly, due to variations in driving habits, service practices and differences in road characteristics and climate.

### Traction AA, A, B and C

The traction grades, from highest to lowest, are AA, A, B, and C. Those grades represent the tire's ability to stop on wet pavement as measured under controlled conditions, on specified government test surfaces of asphalt and concrete. A tire marked C may have poor traction performance.

### WARNING

**The traction grade assigned to your vehicle tires is based on straight-ahead braking traction tests, and does not include acceleration, cornering, hydroplaning, or peak traction characteristics.**

### Temperature A, B and C

Temperature grades are A (the highest), B, and C. They represent a tire's resistance to heat build-up, and its ability to dissipate heat when tested under controlled conditions on a specified indoor laboratory test wheel. Sustained high temperature can cause tire material to degenerate, reducing tire life. Excessive temperatures can lead to sudden tire failure. Grade C corresponds to a performance level which all passenger car tires must meet under the Federal Motor Vehicle Safety Standard No. 109. Grades A and B represent higher levels of performance on laboratory test wheels than the minimum required by law.

 **WARNING**

The temperature grade for this tire is established for a tire that is properly inflated and not overloaded. Excessive speed, under inflation, or excessive loading, either separately or in combination, can cause heat build-up and possible tire failure.

## EMISSION CONTROL SYSTEM WARRANTY

Your NISSAN is covered by the following emission warranties:

### For US

- 1) Emission Defects Warranty
- 2) Emission Performance Warranty

### For Canada

#### Emission Control System Warranty

Details of these warranties may be found with other vehicle warranties in your Warranty Information and Maintenance Log Booklet that comes with your NISSAN. If you did not receive a Warranty Information and Maintenance Log Booklet, or it has become lost, you may obtain a replacement by writing to:

- Nissan North America, Inc.  
Consumer Affairs Department  
P.O. Box 191  
Gardena, CA 90248-0191
- Nissan Canada Inc.  
5290 Orbitor Drive  
Mississauga, Ontario, L4W 4Z5

## REPORTING SAFETY DEFECTS (US only)

If you believe that your vehicle has a defect which could cause a crash or could cause injury or death, you should immediately inform the National Highway Traffic Safety Administration (**NHTSA**) in addition to notifying NISSAN.

If **NHTSA** receives similar complaints, it may open an investigation, and if it finds that a safety defect exists in a group of vehicles, it may order a recall and remedy campaign. However, **NHTSA** cannot become involved in individual problems between you, your dealer, or NISSAN.

To contact **NHTSA**, you may either call the Auto Safety Hotline toll-free at 1- 800-424-9393 (or 366-0123 in the Washington, D.C. area) or write to: **NHTSA**, U.S. Department of Transportation, Washington, D.C. 20590. You can also obtain other information about motor vehicle safety from the Hotline.

You may notify NISSAN by contacting our Consumer Affairs Department, toll-free, at 1-800-NISSAN-1.

In Hawaii, call (808) 836-0888.

## READINESS FOR INSPECTION/MAINTENANCE (I/M) TEST (US only)

Due to legal requirements in some states and Canadian Provinces, your vehicle may be required to be in the ready condition for an Inspection/Maintenance (I/M) test of the emission control system.

The vehicle is set to the ready condition when it is driven through certain driving patterns. Usually, the ready condition can be obtained by ordinary usage of the vehicle.

If a powertrain system component is repaired or the battery is disconnected, the vehicle may be reset to a not ready condition. Before taking the I/M test, drive the vehicle through the following pattern to set the vehicle to the ready condition. If you cannot or do not want to perform the driving pattern, an authorized NISSAN dealer can conduct it for you.

### **WARNING**

**Always drive the vehicle in a safe manner according to traffic conditions and obey all traffic laws.**

1. Start the engine when the engine coolant temperature gauge needle points to C. Allow the engine to idle until the gauge needle points between the C and H (normal operating temperature).

2. Accelerate the vehicle to 55 MPH (88 km/h), then quickly release the accelerator pedal completely and keep it released for at least 6 seconds.
3. Quickly depress the accelerator pedal for a moment, then drive the vehicle at a speed of 53 to 60 MPH (86 to 96 km/h) for at least 5 minutes.
4. Stop the vehicle.
5. Accelerate the vehicle to 35 mph (55 km/h) and maintain the speed for 20 seconds.
6. Repeat steps four through five at least three times.
7. Accelerate the vehicle to 55 mph (88 km/h) and maintain the speed for at least 3 minutes.
8. Stop the vehicle and turn the engine off.
9. Repeat steps one through eight at least one more time.

If step one through seven are interrupted, repeat the preceding step. Any safe driving mode is acceptable between steps. Do not stop the engine until step seven is completed.

## **Genuine Nissan Service Manuals**

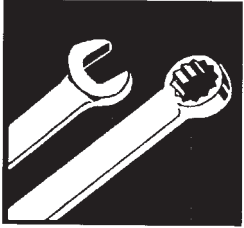

# **GET THE INSIDE STORY**

A Genuine NISSAN Service Manual is the best source of service and repair information for your vehicle. Filled with wiring diagrams, illustrations and step-by-step diagnostic and adjustment procedures, this manual is the same one used by the factory trained technicians working at an authorized NISSAN dealership. Also available are Genuine NISSAN Owner's Manuals.

For current pricing and availability of a Genuine NISSAN Service Manual or Genuine NISSAN Owner's Manual, contact:

### **In the USA:**

See an authorized NISSAN dealer or contact:  
Dyment Distribution Services  
20770 Westwood Dr.  
Strongsville OH 44136

In a hurry? Call 1-800-247-5321 and charge your purchase to Visa/Master Card.

### **In Canada:**

To purchase a copy of a Genuine NISSAN Service Manual or Owner's Manual please contact your nearest NISSAN Dealer. For the phone number and location of a NISSAN Dealer in your area call the NISSAN Satisfaction Center at 1-800-387-0122 and a bilingual NISSAN representative will assist you.

Also available are Genuine NISSAN Service and Owner's Manuals for older NISSAN models.

**MEMO**

10-22 **Technical and consumer information**

# 11 Index

## A

After an accident.....	6-11
Air bag (See supplemental restraint system) .....	1-19
Air bag warning light.....	1-24
Air cleaner housing filter.....	8-13
Air conditioner	
Air conditioner operation .....	4-5
Air conditioner service .....	4-14
Air conditioner specification label .....	10-11
Air conditioner system refrigerant and lubrication recommendations.....	10-6
Heater and air conditioner (automatic) (if so equipped).....	4-11
Heater and air conditioner (manual).....	4-3
Rear seat air conditioner .....	4-14
Air filter	
Cabin air filter .....	8-14
Air flow charts .....	4-7
Alarm system (See theft warning) .....	2-10
Anchor point locations .....	1-57
Anti-lock brake system (ABS).....	5-15
Anti-lock brake warning light .....	2-8
Armrests.....	1-6
Ashtray (See cigarette lighter and ashtray).....	2-17

Audio system	
AM-FM radio with cassette player.....	4-16
AM-FM radio with cassette player and compact disc player.....	4-22
Compact disc (CD) player.....	4-28, 4-30
Autolamp switch.....	2-14
Automatic	
Automatic power window switch .....	2-21
Automatic transmission fluid (ATF) .....	8-8
Driving with automatic transmission .....	5-5
Transmission selector lever lock release .....	5-6

## B

Battery.....	8-11
Before starting the engine .....	5-5
Brake	
Anti-lock brake system (ABS) .....	5-15
Brake booster .....	8-20
Brake fluid .....	10-2, 8-10
Brake light (See stop light) .....	8-23
Brake pedal .....	8-19
Brake system.....	5-14
Brake warning light.....	2-7
Brake wear indicators.....	2-9
Parking brake check.....	8-19
Parking brake operation .....	5-9

Self-adjusting brakes.....	8-19
Break-in schedule .....	5-11
Bulb check/instrument panel .....	2-6
Bulb replacement.....	8-23

## C

Cabin air filter .....	8-14
Capacities and recommended fuel/lubricants.....	10-2
Cargo net.....	3-16
Cargo (See vehicle loading information) .....	10-12
Cassette player (See audio system) .....	4-16
CB radio or car phone.....	4-33
Check engine indicator light (See malfunction indicator light) .....	2-9
Child restraint with top tether strap .....	1-51
Child restraints.....	1-41
Child safety sliding door lock.....	3-6
Cigarette lighter (accessory) and ashtray .....	2-17
Cleaning exterior and interior .....	7-2
Clock.....	4-16, 4-22
Cold weather driving.....	5-16
Compact disc (CD) player.....	4-28, 4-30



<b>Controls</b>	
Audio controls (rear).....	4-33
Audio controls (steering wheel).....	4-32
Heater and air conditioner controls (automatic).....	4-11
Heater and air conditioner controls (manual).....	4-3
Rear seat air conditioner controls .....	4-14
<b>Coolant</b>	
Capacities and recommended fuel/lubricants .....	10-2
Changing engine coolant.....	8-5
Checking engine coolant level .....	8-4
Engine coolant temperature gauge .....	2-4
Cornering light .....	2-15
Corrosion protection .....	7-4
Cruise control.....	5-9
Cup holder .....	2-19

## D

Daytime running light system (Canada only) .....	2-14
<b>Defogger switch</b>	
Rear window defogger switch .....	2-13
Dimensions and weights.....	10-8
Door ajar warning light .....	2-7
Door locks.....	3-2
Drive belts.....	8-12

<b>Driving</b>	
Cold weather driving.....	5-16
Driving with automatic transmission.....	5-5
Precautions when starting and driving... ..	5-2

## E

Economy - fuel.....	5-12
Emission control information label.....	10-10
Emission control system warranty.....	10-19
<b>Engine</b>	
Before starting the engine .....	5-5
Capacities and recommended fuel/lubricants .....	10-2
Changing engine coolant.....	8-5
Changing engine oil.....	8-6
Changing engine oil filter.....	8-7
Checking engine coolant level .....	8-4
Checking engine oil level .....	8-5
Engine compartment check locations ....	8-3
Engine coolant temperature gauge .....	2-4
Engine cooling system .....	8-4
Engine oil.....	8-5
Engine oil and oil filter recommendation .....	10-4
Engine oil pressure warning light.....	2-6
Engine oil viscosity .....	10-5
Engine serial number .....	10-10
Starting the engine .....	5-8
Exhaust gas (Carbon monoxide).....	5-2

## F

Five passenger seating .....	1-70
Five passenger seating with cargo room ..	1-71
Flashers (See hazard warning flasher switch).....	2-16
Flat tire.....	6-2
Flexible seating.....	1-8
Floor mat positioning.....	1-69, 1-72
Floor mat positioning aid .....	1-72
<b>Fluid</b>	
Automatic transmission fluid (ATF) .....	8-8
Brake fluid .....	10-2, 8-10
Capacities and recommended fuel/lubricants .....	10-2
Engine coolant.....	8-4
Engine oil.....	8-5
Power steering fluid .....	10-2, 8-9
Window washer fluid .....	8-10
F.M.V.S.S. certification label .....	10-10
Front seat convenience net.....	3-14
<b>Fuel</b>	
Capacities and recommended fuel/lubricants .....	10-2
Fuel economy .....	5-12
Fuel filler lid and cap .....	3-20
Fuel filler lid lock opener lever .....	3-20
Fuel gauge.....	2-5
Fuel octane rating.....	10-3
Fuel recommendation.....	10-2
Fuses .....	8-20

## G

Gauge	
Engine coolant temperature gauge .....	2-4
Fuel gauge.....	2-5
Odometer.....	2-4
Speedometer .....	2-4
Tachometer.....	2-4
Trip odometer .....	2-4
General maintenance .....	9-2
Glove box.....	3-13

## H

Hazard warning flasher switch .....	2-16
Head restraints .....	1-6
Headlight control switch.....	2-13
Headlights .....	8-22
Heater	
Heater and air conditioner (automatic) (if so equipped).....	4-11
Heater and air conditioner (manual).....	4-3
Rear seat air conditioner .....	4-14
Homelink Transceiver	
Integrated HomeLink® Universal Transceiver (If so equipped) .....	2-27
Hood release .....	3-12

## I

Ignition switch .....	5-4
Important vehicle information label.....	10-10
Increasing fuel economy.....	5-12
Indicator lights and chimes (See warning/ indicator lights and chimes).....	2-6
Inertial fuel shut off switch.....	6-11
Inside mirror.....	3-24
Instrument brightness control .....	2-16
Integrated child safety seats.....	1-61
Integrated HomeLink® Universal Transceiver (If so equipped).....	2-27
Interior lights .....	2-24

## J

Jump starting.....	6-8, 8-12
--------------------	-----------

## K

Key.....	3-2
Keyless entry system (See multi-remote control system) .....	3-9

## L

### Labels

Air conditioner specification label.....	10-11
Emission control information label.....	10-10

Engine serial number .....	10-10
F.M.V.S.S. certification label .....	10-10
Vehicle identification number (VIN).....	10-9
Vehicle identification number (VIN) plate .....	10-9
Warning labels (for SRS) .....	1-24
License plate	
Installing the license plate .....	10-11
Light	
Air bag warning light.....	1-24
Brake light (See stop light).....	8-23
Bulb check/instrument panel .....	2-6
Bulb replacement.....	8-23
Cornering light .....	2-15
Headlight control switch .....	2-13
Headlights .....	8-22
Interior lights .....	2-24
Light bulbs .....	8-22
Luggage compartment lights .....	2-24
Map lights .....	2-25
Warning/indicator lights and chimes .....	2-6
Lock	
Child safety sliding door lock .....	3-6
Door locks.....	3-2
Fuel filler lid lock opener lever .....	3-20
Power door lock.....	3-7
Rear door lock .....	3-15
Luggage compartment lights .....	2-24
Luggage rack.....	3-19
Luggage (See vehicle loading information) .....	10-12

**M**

Maintenance	
General maintenance .....	9-2
Inside the vehicle.....	9-3
Maintenance precautions .....	8-2
Outside the vehicle.....	9-2
Periodic maintenance schedules.....	9-5
Seat belt maintenance.....	1-40
Under the hood and vehicle .....	9-4
Malfunction indicator light.....	2-9
Manual front seat adjustment .....	1-3
Manual vent windows .....	2-23
Map lights .....	2-25
Map pockets .....	2-20
Mirror	
Inside mirror.....	3-24
Outside mirror control.....	3-23
Outside mirrors .....	3-24
Vanity mirror .....	3-24
Multi-remote control system .....	3-9

**O**

Odometer .....	2-4
Oil	
Capacities and recommended fuel/ lubricants .....	10-2
Changing engine oil.....	8-6
Changing engine oil filter.....	8-7
Checking engine oil level .....	8-5

Engine oil.....	8-5
Engine oil and oil filter recommendation .....	10-4
Engine oil viscosity .....	10-5
Outside mirror control.....	3-23
Outside mirrors .....	3-24
Overdrive switch .....	5-7
Overhead storage compartment.....	2-20
Overheat	
If your vehicle overheats .....	6-10
Owner's manual order form.....	10-21

**P**

Parcel shelf.....	3-17
Parking	
Parking brake check .....	8-19
Parking brake operation .....	5-9
Parking/parking on hills .....	5-13
Periodic maintenance schedules.....	9-5
Personal reading light.....	2-24
Power	
Power door lock.....	3-7
Power steering fluid .....	10-2, 8-9
Power support front seat .....	1-4
Power vent windows.....	2-23
Power windows.....	2-21
Precautions	
Maintenance precautions .....	8-2
Precautions on seat belt usage.....	1-26
Precautions when starting and driving... ..	5-2
Push starting.....	6-10

**R**

Radio	
AM-FM radio with cassette player.....	4-16
AM-FM radio with cassette player and compact disc player.....	4-22
CB radio or car phone .....	4-34
Readiness for inspection maintenance (I/M) test.....	10-20
Rear door.....	3-15
Rear door lock .....	3-15
Rear power point .....	2-18
Rear seat air conditioner .....	4-14
Rear window defogger switch .....	2-13
Rear window wiper and washer switches .....	2-13
Refrigerant recommendation .....	10-6
Registering your vehicle in another country .....	10-9
Remote keyless entry system (See multi-remote control system) .....	3-9
Removing and installing the second row bench seat .....	1-8
Reporting safety defects (USA).....	10-19

**S**

Safety	
Child safety sliding door lock .....	3-6
Reporting safety defects (USA).....	10-19
Seat belt	
Precautions on seat belt usage.....	1-26

Seat belt extenders .....	1-40
Seat belt maintenance.....	1-40
Seat belts.....	1-26
Three-point type with retractor....	1-29, 1-32
Two-point type without retractor.....	1-38
Seat belt warning light.....	2-7
Seat positions .....	1-73
Seating arrangements .....	1-68
Seats	
Five passenger seating .....	1-70
Five passenger seating with cargo room.....	1-71
Flexible seating.....	1-8
Integrated child safety seats .....	1-61
Manual front seat adjustment.....	1-3
Power support front seat .....	1-4
Seat positions .....	1-73
Second row bench seat.....	1-73
Second row bucket seats .....	1-77
Seven passenger seating.....	1-69
Sliding three-passenger seat.....	1-15
Three-passenger bench seat in fully forward position .....	1-71
Three-passenger bench seat in storage position .....	1-69
Seats/floor mats.....	1-68
Selector lever lock release .....	5-6
Self-adjusting brakes .....	8-19
Service manual order form .....	10-21
Seven passenger seating.....	1-69
Shifting	
Automatic transmission .....	5-6

Shift lock release .....	5-6
Sliding three-passenger seat.....	1-15
Spark plug replacement.....	8-12
Speedometer .....	2-4
Spotlights (See map lights) .....	2-25
SRS warning label .....	1-24
Starting	
Before starting the engine .....	5-5
Jump starting.....	6-8, 8-12
Precautions when starting and driving...	5-2
Push starting.....	6-10
Starting the engine .....	5-8
Steering	
Power steering fluid .....	10-2, 8-9
Tilting steering wheel.....	3-21
Stop light.....	8-23
Storage	
Overhead storage compartment.....	2-20
Under seat storage tray.....	1-7
Storage compartment for garage door transmitter .....	2-25
Sun shade.....	2-23
Sunroof .....	2-22
Supplemental restraint system	
Information and warning labels .....	1-24
Switch	
Autolamp switch .....	2-14
Automatic power window switch .....	2-21
Hazard warning flasher switch .....	2-16
Headlight control switch .....	2-13
Ignition switch .....	5-4
Overdrive switch .....	5-7

Rear window defogger switch .....	2-13
Rear window wiper and washer switches .....	2-13
Turn signal switch.....	2-15
Windshield wiper and washer switch ...	2-12

## T

Tabletop seats .....	1-7
Tachometer.....	2-4
Theft warning .....	2-10
Three way catalyst.....	5-2
Three-passenger bench seat.....	1-37
Three-passenger bench seat in fully forward position .....	1-71
Three-passenger bench seat in storage position.....	1-69
Tilting steering wheel.....	3-21
Timing belt .....	10-7
Tire	
Flat tire.....	6-2
Spare tire .....	8-31
Tire chains .....	8-29
Tire placard.....	10-11
Tire pressure .....	5-6
Tire pressure .....	8-27
Tire rotation .....	8-29
Tool kit.....	6-2
Types of tires.....	8-28
Uniform tire quality grading .....	10-18
Wheels and tires .....	10-8, 8-27

Wheel/tire size .....	10-8
Towing	
Tow truck towing .....	6-12
Towing load/specification chart .....	10-14
Trailer towing .....	10-13
Transceiver	
Integrated HomeLink® Universal	
Transceiver (If so equipped) .....	2-27
Transmission	
Automatic transmission fluid (ATF) .....	8-8
Driving with automatic transmission .....	5-5
Selector lever lock release .....	5-6
Travel (See registering your vehicle in	
another country).....	10-9
Trip odometer .....	2-4
Tuning.....	4-17, 4-23
Turn signal switch.....	2-15

## U

Under seat storage tray.....	1-7
Uniform tire quality grading .....	10-18

## V

Vanity mirror .....	3-24
Vehicle dimensions and weights .....	10-8
Vehicle identification .....	10-9
Vehicle identification number (VIN) .....	10-9
Vehicle identification number (VIN)	
(chassis number) .....	10-9

Vehicle identification number (VIN) plate ..	10-9
Vehicle loading information .....	10-12
Vehicle recovery .....	6-14
Ventilators .....	4-2

## W

Warning	
Air bag warning light.....	1-24
Hazard warning flasher switch .....	2-16
Theft warning.....	2-10
Warning labels (for SRS) .....	1-24
Warning/indicator lights and chimes .....	2-6
Weights (See dimensions and weights)....	10-8
Wheels and tires .....	10-8, 8-27
Wheel/tire size .....	10-8
When traveling or registering your vehicle in	
another country .....	10-9
Window washer fluid.....	8-10
Windows	
Locking passengers' windows.....	2-22
Manual vent windows .....	2-23
Power vent windows.....	2-23
Power windows.....	2-21
Windshield wiper and washer switch .....	2-12
Wiper	
Rear window wiper and washer	
switches .....	2-13
Windshield wiper and washer switch ...	2-12
Wiper blades.....	8-17

## GAS STATION INFORMATION

### Recommended fuel:

Unleaded gasoline, at least 87 AKI number (RON 91).

For further details such as gasohol, see "Fuel recommendation" in the "Technical and consumer information" section.

### Recommended engine oil:

- API Certification Mark
- API SG/SH, Energy Conserving II or API grade SJ Energy Conserving
- ILSAC grade GF-II

See "Engine oil and oil filter recommendation" in the "Technical and consumer information" section.

### Cold tire pressure:

See tire placard affixed to the glove compartment lid.

### Recommended new vehicle break-in procedure:

During the first 1,000 miles (1,600 km) of vehicle use, follow the recommendations outlined in the "Break-in schedule" information found in the "Starting and Driving" section of this Owner's Manual. Follow these recommendations for the future reliability and economy of your new vehicle. Failure to follow these recommendations may result in vehicle damage or shortened engine life.

## QUICK REFERENCE

