

# *2005 Owner's Manual*

# ***SONATA***



**HYUNDAI**

A010A02A-AAT

### WARRANTIES FOR YOUR HYUNDAI VEHICLE

- o New Vehicle 60 Months/60,000 Miles Limited Warranty
- o New Vehicle 120 Months/100,000 Miles Limited Powertrain Warranty (original owner only)
- o Anti-Perforation Limited Warranty
- o Emission Defect Warranty - Federal Vehicle
- o California Emission Control System Warranty (if applicable)
- o Emission Performance Warranty - Federal Vehicle
- o Replacement Parts and Accessories Limited Warranty

**NOTE:**

**Detailed warranty information is provided in your Hyundai Owner's Handbook.**

A020A01A-AAT

### RESPONSIBILITY FOR MAINTENANCE

The maintenance requirements for your new Hyundai are found in Section 5. As the owner, it is your responsibility to see that all maintenance operations specified by the manufacturer are carried out at the appropriate intervals. When the vehicle is used in severe driving conditions, more frequent maintenance is required for some operations. Maintenance requirements for severe operating conditions are also included in Section 5.

# HYUNDAI

# SONATA



## OWNER'S MANUAL

A030A01NF-AAT

**Operation  
Maintenance  
Specifications**

A030A01NF-A

All information in this Owner's Manual is current at the time of publication. However, Hyundai reserves the right to make changes at any time so that our policy of continual product improvement may be carried out.

This manual applies to all Hyundai **SONATA** models and includes descriptions and explanations of optional as well as standard equipment. As a result, you may find material in this manual that does not apply to your specific vehicle.

A070A01A-AAT



### **CAUTION: MODIFICATIONS TO YOUR HYUNDAI**

Your Hyundai should not be modified in any way. Such modifications may adversely affect the performance, safety or durability of your Hyundai and may, in addition, violate conditions of the limited warranties covering the vehicle. Certain modifications may also be in violation of regulations established by the U.S. Department of Transportation and other federal or state agencies.

A080A01S-AAT

### **TWO-WAY RADIO OR CELLULAR TELEPHONE INSTALLATION**

Your vehicle is equipped with electronic fuel injection and other electronic components. It is possible for an improperly installed/adjusted two-way radio or cellular telephone to adversely affect electronic systems. For this reason, we recommend that you carefully follow the radio manufacturer's instructions or consult your Hyundai dealer for precautionary measures or special instructions if you choose to install one of these devices.

## FOREWORD

Thank you for choosing Hyundai. We are pleased to welcome you to the growing number of discriminating people who drive Hyundais. The advanced engineering and high-quality construction of each Hyundai we build is something of which we're very proud.

Your Owner's Manual will introduce you to the features and operation of your new Hyundai. It is suggested that you read it carefully because the information it contains can contribute greatly to the satisfaction you receive from your new car.

The manufacturer also recommends that all service and maintenance on your car be performed by an authorized Hyundai dealer. Hyundai dealers are prepared to provide high-quality service, maintenance and any other assistance that may be required.

## HYUNDAI MOTOR COMPANY

**Note** : Because future owners will also need the information included in this manual, if you sell this Hyundai, please leave the manual in the vehicle for their use. Thank you.



### **CAUTION:**

**Severe engine and transaxle damage may result from the use of poor quality fuels and lubricants that do not meet Hyundai specifications. You must always use high quality fuels and lubricants that meet the specifications listed on Page 9-4 in the Vehicle Specifications section of the Owner's Manual and which also appear in the Service Station Information on the back cover of the Owner's Manual.**

Copyright 2005 Hyundai Motor Company. All rights reserved. No part of this publication may be reproduced, stored in any retrieval system or transmitted in any form or by any means without the prior written permission of Hyundai Motor Company.

## SAFETY AND VEHICLE DAMAGE WARNING

This manual includes information titled as WARNING, CAUTION and NOTE.  
These titles indicate the following:



### **WARNING:**

This indicates that a condition may result in harm, serious injury or death to you or other persons if the warning is not heeded. Follow the advice provided with the warning.



### **CAUTION:**

This indicates that a condition may result in damage to your vehicle or its equipment if the caution is not heeded. Follow the advice provided with the caution.

### **NOTE:**

This indicates that interesting or helpful information is being provided.

# TABLE OF CONTENTS

<b>FEATURES OF YOUR HYUNDAI</b>	<b>1</b>
<b>DRIVING YOUR HYUNDAI</b>	<b>2</b>
<b>WHAT TO DO IN AN EMERGENCY</b>	<b>3</b>
<b>CORROSION PREVENTION &amp; APPEARANCE CARE</b>	<b>4</b>
<b>VEHICLE MAINTENANCE REQUIREMENTS</b>	<b>5</b>
<b>DO-IT-YOURSELF MAINTENANCE</b>	<b>6</b>
<b>EMISSION CONTROL SYSTEMS</b>	<b>7</b>
<b>CONSUMER INFORMATION, REPORTING SAFETY DEFECTS &amp; BINDING ARBITRATION OF WARRANTY CLAIMS</b>	<b>8</b>
<b>VEHICLE SPECIFICATIONS</b>	<b>9</b>
<b>INDEX</b>	<b>10</b>

# INSTRUMENTS AND CONTROLS (I)

B250A01NF-AAT



B250A01NF-A



1. Electronic Stability Control (ESC) Switch
2. Power Adjustable Pedals Switch (If Installed)
3. Panel Brightness Control Knob (Rheostat Switch)
4. Hood Release Lever
5. Steering Wheel Tilt Lever (If Installed)
6. Front Seat Warmer (If Installed)

7. Power Outlet
8. Ashtray
9. Cigarette Lighter
10. Digital Clock
11. "PASSENGER AIR BAG OFF" Indicator
12. Hazard Warning Switch



**CAUTION:**

**When installing a container of liquid air freshener inside the vehicle, do not place it near the instrument cluster nor on the instrument panel surface. If there is any leakage from the air freshener onto these areas (Instrument cluster, instrument panel or air ventilator), it may damage these parts. If the liquid from the air freshener does leak onto these areas, wash them with water immediately.**

## INSTRUMENTS AND CONTROLS (II)

B250B01NF-AAT

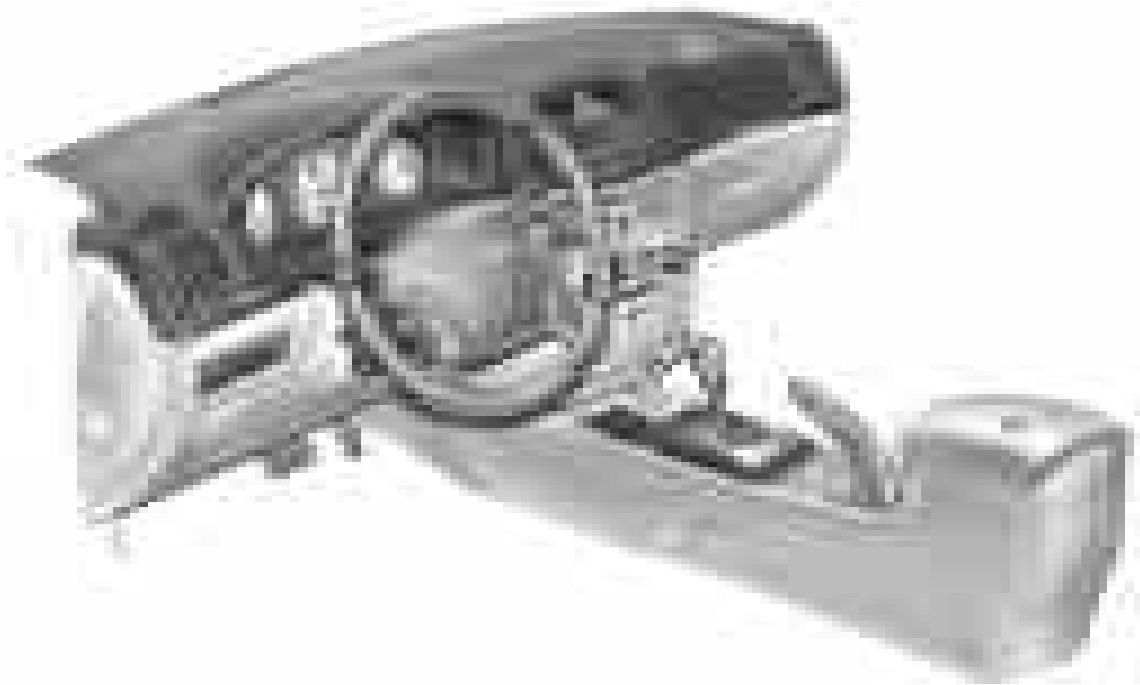

B250A02NF-A

1. Fuse Box
2. Multi Box
3. Instrument Cluster
4. Multi-Function Light/Front Fog Light Switch
5. Audio Remote Control Switch (If Installed)
6. Horn and Driver's Airbag
7. Windshield Wiper/Washer Switch
8. Cruise Control Switch
9. Audio System (If Installed)
10. Passenger's Airbag
11. Glove Box
12. Heating/Air Conditioning Control Panel
13. Shift Lever
14. Parking Brake Lever
15. Drink Holder
16. Center Console



















**CAUTION:**

**When installing a container of liquid air freshener inside the vehicle, do not place it near the instrument cluster nor on the instrument panel surface. If there is any leakage from the air freshener onto these areas (Instrument cluster, instrument panel or air ventilator), it may damage these parts. If the liquid from the air freshener does leak onto these areas, wash them with water immediately.**

B255A01NF-AAT

**INDICATOR SYMBOLS ON THE INSTRUMENT CLUSTER**

	SRS (Airbag) Warning Light		Door Ajar Warning Light
	Turn Signal Indicator Lights		Low Fuel Level Warning Light
	Seat Belt Reminder Light		Check Engine - Malfunction Indicator Light (MIL)
	High Beam Indicator Light		ABS Service Reminder Indicator (If Installed)
	Front Fog Light Indicator Light		Electronic Stability Control (ESC) Indicator Lights (If Installed)
	Low Oil Pressure Warning Light		Cruise Indicator Light
	Parking Brake/Low Brake Fluid Level Warning Light		Cruise SET Indicator Light
	Charging System Warning Light		Low Windshield Washer Fluid Level Warning Light
	Trunk Lid Open Warning Light		

\* More detailed explanations of these items will be found beginning on page 1-52.

## Guide to Hyundai Genuine Parts

### 1. What are Hyundai Genuine Parts?

Hyundai Genuine Parts are the same parts used by Hyundai Motor Company to manufacture vehicles. They are designed and tested for the optimum safety, performance, and reliability to our customers.

### 2. Why should you use genuine parts?

Hyundai Genuine Parts are engineered and built to meet rigid manufacturing requirements. Using imitation, counterfeit or used salvage parts is not covered under the Hyundai New Vehicle Limited Warranty or any other Hyundai warranty. In addition, any damage to or failure of Hyundai Genuine Parts caused by the installation or failure of

an imitation, counterfeit or used salvage part is not covered by any Hyundai Warranty.

### 3. How can you tell if you are purchasing Hyundai Genuine Parts?

Look for the Hyundai Genuine Parts Logo on the package (see below).

Hyundai Genuine Parts exported to the United States are packaged with labels written only in English.

Hyundai Genuine Parts are only sold through authorized Hyundai Dealerships.

To find the closest authorized dealer call  
**1-800-826-CARS**

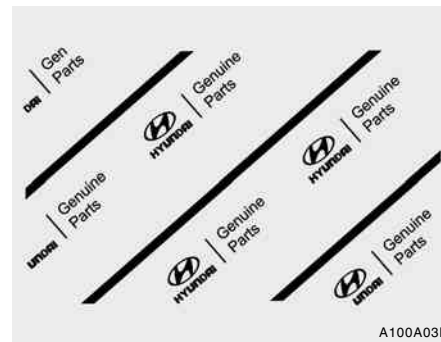

A100A03L



A100A01L



A100A02L

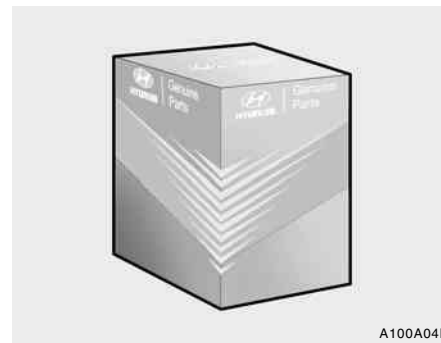

A100A04L

# FEATURES OF YOUR HYUNDAI

Fuel Recommendations .....	1-2
Breaking in Your New Hyundai .....	1-3
Keys .....	1-3
Door Locks .....	1-4
Theft-Alarm System .....	1-8
Windows .....	1-11
Seats .....	1-14
Seat Belts .....	1-21
Child Restraint System .....	1-28
Advanced Supplemental Restraint (AIRBAG) System (SRS) .....	1-36
Instrument Cluster and Indicator Lights .....	1-50
Warning and Indicator Lights .....	1-52
Trip Computer .....	1-58
Multi-Function Light Switch .....	1-61
Windshield Wiper and Washer Switch .....	1-64
Sunroof .....	1-70
Mirror .....	1-77
Homelink Mirror .....	1-79
Hood Release .....	1-89
Cruise Control .....	1-93
Heating and Cooling Control .....	1-96
Stereo Sound System .....	1-113
Audio System .....	1-115
Antenna .....	1-130

## FUEL RECOMMENDATIONS

B010A01NF-AAT

**Use Unleaded Gasoline**

Unleaded gasoline with a Pump Octane Rating of 87 (Research Octane Number 91) or higher must be used in your Hyundai.

**CAUTION:**

- o Do not "TOP-OFF" after the first nozzle shut off when refueling.
- o The fuel cap must be tightened until cap clicks, otherwise "  " light will illuminate.

B010B01A-AAT

**What About Gasohol?**

Gasohol (a mixture of 90% unleaded gasoline and 10% ethanol or grain alcohol) may be used in your Hyundai. However, if your engine develops driveability problems, the use of 100% unleaded gasoline is recommended. Fuels with unspecified quantities of alcohol, or alcohols other than ethanol, should not be used.

B010C01A-AAT

**Use of MTBE**

Hyundai recommends that fuels containing MTBE (Methyl Tertiary Butyl Ether) over 15.0% vol. (Oxygen Content 2.7% weight) should not be used in your Hyundai.

Fuel containing MTBE over 15.0% vol. (Oxygen Content 2.7% weight) may reduce vehicle performance and produce vapor lock or hard starting.

B010D01A-AAT

**Do Not Use Methanol**

Fuels containing methanol (wood alcohol) should not be used in your Hyundai. This type of fuel can reduce vehicle performance and damage components of the fuel system.

**CAUTION:**

Your Hyundai's New Vehicle Limited Warranty may not cover damage to the fuel system and any performance problems that are caused by the use of fuels containing methanol or fuels containing MTBE (Methyl Tertiary Butyl Ether) over 15.0% vol. (Oxygen Content 2.7% weight.)

## BREAKING IN YOUR NEW HYUNDAI

## KEYS

B010E01A-AAT

**Gasolines for Cleaner Air**

To help contribute to cleaner air, Hyundai recommends that you use gasolines treated with detergent additives, which help prevent deposit formation in the engine. These gasolines will help the engine run cleaner and enhance performance of the Emission Control System.

B010F01A-AAT

**Operation in Foreign Countries**

If you are going to drive your Hyundai in another country, be sure to:

- o Observe all regulations regarding registration and insurance.
- o Determine that acceptable fuel is available.

B020A01S-AAT

**During the First 1,200 Miles (2,000 Km)**

No formal "break-in" procedure is required with your new Hyundai. However, you can contribute to the economical operation and durability of your Hyundai by observing the following recommendations during the first 1,200 miles (2,000 km).

- o Don't drive faster than 55 MPH (88 km/h).
- o While driving, keep your engine speed (rpm, or revolutions per minute) between 2,000 rpm and 4,000 rpm.
- o Use moderate acceleration. Don't start quickly or depress the accelerator pedal fully.
- o For the first 200 miles (300 km), try to avoid hard stops.
- o Don't lug the engine (in other words, don't drive so slowly in too high a gear that the engine "bucks": shift to a lower gear).
- o Whether going fast or slow, vary your speed from time to time.
- o Don't let the engine idle longer than 3 minutes at one time.
- o Don't tow a trailer during the first 1,200 miles (2,000 km) of operation.

B030A01NF-GAT

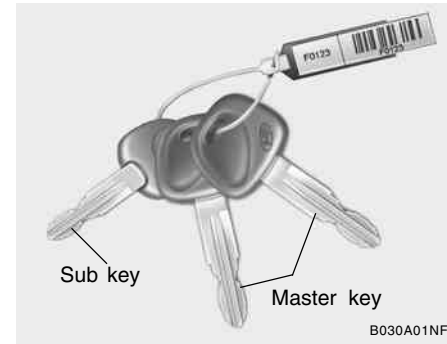

For greater convenience, your Hyundai has two master keys and a sub key. The master keys will open all locks on your vehicle. The sub key will only function in the ignition and the door locks.

Leaving your sub key with a parking attendant will ensure that your vehicle's trunk, trunk lid release, glove box compartment and rear trunk access may not be unlocked in your absence.

**NOTE:**

**Before leaving your sub key with a parking attendant, make sure that the lock knobs of the rear seatback lock and the trunk lid lock are switched to the "LOCK" position.**

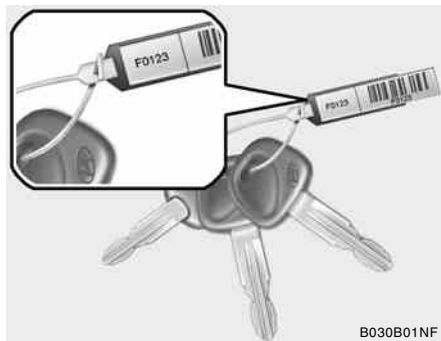

B030B01NF-GAT

**Record Your Key Number**

A code number is attached on the number tag that came with the keys to your Hyundai. This key number tag should not be left with the keys but kept in a safe place, not in the vehicle. The key number should also be recorded in a place where it can be found in an emergency.

If you need additional keys, or if you should lose your keys, your authorized Hyundai dealer can make new keys if you can supply the key number.

B030C01JM-AAT

**ILLUMINATED IGNITION SWITCH**

Whenever either front door is opened, the ignition switch will be illuminated for your convenience, provided the ignition switch is not in the "ON" position.

The light will go off approximately 10 seconds after closing the door or when the ignition switch is turned on.

**DOOR LOCKS**

B040A01A-AAT

**WARNING:**

- o Unlocked doors can be dangerous. Before you drive away (especially if there are children in the car), be sure that all the doors are securely closed and locked so that the doors cannot be opened from the inside. This helps ensure that the doors will not be opened accidentally. Also, when combined with the proper use of seat belts, locking the doors helps keep occupants from being ejected from the car in case of an accident.
- o Before opening the door, always look for and avoid oncoming traffic.

B040B01JM-AAT

### Locking, unlocking front doors with a key



- o The door can be locked or unlocked with a key.
- o Lock the door by turning the key toward the front of the vehicle and unlock it by turning the key toward the rear.

#### NOTE:

The driver's door can be unlocked by turning the key once toward the rear. If you wish to unlock all doors, turn the key again toward the rear within 4 seconds. The passenger's side will lock or unlock all doors with just one rotation.

B040C02Y-AAT

### Locking from the Outside

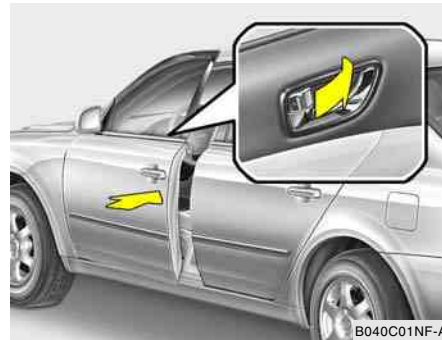

The doors can be locked without a key. To lock the doors from the outside, first push the inside lock switch to the "LOCK" position, so that the red mark on the switch is not visible, then close the door.

The door will not lock if the key is left in the ignition switch when the front doors are closed. This is normal.

#### NOTE:

- o When locking the door this way, be careful not to lock the door with the key left in the vehicle.
- o To discourage theft, always remove the ignition key, close all windows and lock all doors when leaving your vehicle unattended.

B040D01NF-AAT

### Locking from the Inside

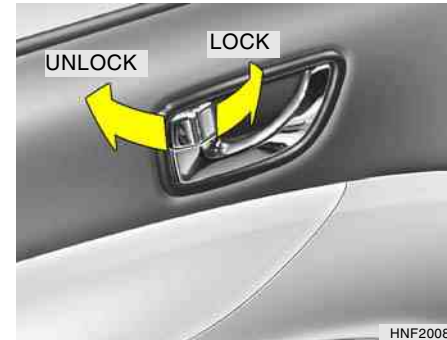

To lock the doors from the inside, simply close the door and push the lock switch to the "LOCK" position.

#### NOTE:

- o When the door is locked, the red mark on the switch is not visible.
- o The driver's and front passenger's doors can be opened by pulling the inside door handle even if the inside lock switch is pushed to the "LOCK" position.



**WARNING:**

Be careful not to pull the inside door handle while driving. If you pull the inside door handle, the door can be opened and you may be ejected from the vehicle and can be injured or killed.

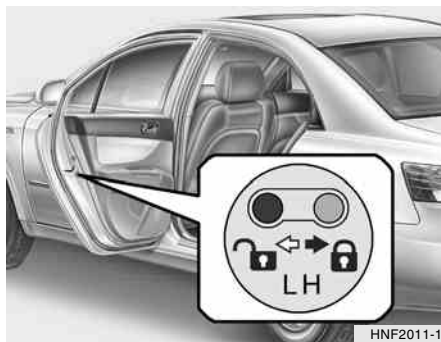
B040E04A-AAT

**Child-Protector Rear Door Lock**

Your Hyundai is equipped with left and right side "child-protector" rear door locks. When the lock mechanism is engaged, the rear door cannot be opened from the inside. Its use is recommended whenever there are small children in the rear seat.

To engage the child-protector feature so that the door cannot be opened from the inside, move the child-protector lever to the "  " position and close the door. Move the lever to the "  " position when normal door operation is desired.

To open the door from the outside, pull the outside door handle.

B040G01NF-AAT

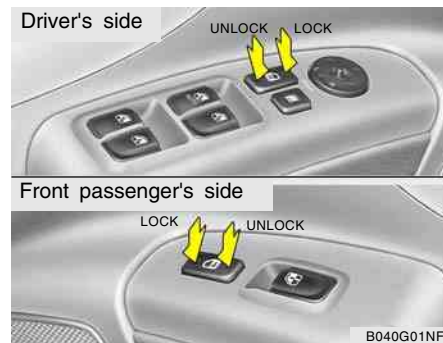
**Central Door Locks**

The central door locking switch is located on the driver's and front passenger's armrest. It is operated by depressing the door lock switch. If any door is open when the switch is depressed to the "LOCK" position, the door will remain locked when closed.

**NOTE:**

- o When depressing the front portion of the driver's or front passenger's door lock switch, all vehicle doors will lock.
- o When depressing the rear portion of these switches, all vehicle doors will unlock.

- o The driver's and front passenger's doors can be opened by pulling the inside door handle even if the front portion of the driver's or front passenger's central door locking switch has been depressed to lock the doors.

**WARNING:**

Be careful not to pull the inside door handle while driving. If you pull the inside door handle, the door can be opened and you may be ejected from the vehicle and can be injured or killed.

B040H02NF-GAT

### Speed Sensing Auto Door Locking (If Installed)

When the speed of the vehicle keeps above the specific speed for 1 second, it will automatically lock all doors for driver and passenger's safety. For further information, contact an authorized Hyundai dealer.

B070F01NF-AAT

### KEYLESS ENTRY SYSTEM

**NOTE:**

This device complies with Part 15 of the FCC rules. Operation is subject to the following two conditions:

(1) This device may not cause harmful interference, and (2) this device must accept any interference received, including interference that may cause undesired operation.

**CAUTION:**

Changes or modifications not expressly approved by the party responsible for compliance could void the user's authority to operate the equipment.

### Locking doors

1. Close all doors.
2. Push the "LOCK 
" button on the transmitter.
3. At the same time, all doors lock and the turn signal lights will blink once to indicate that the system is armed.

### Unlocking doors

1. Push the "UNLOCK 
" button on the transmitter.
2. At the same time, the driver's door unlocks and the turn signal lights will blink twice to indicate that the system is disarmed.

**NOTE:**

If you wish to unlock all the doors, press the "UNLOCK" button on the transmitter again within 4 seconds.

### Releasing the trunk lid

Push the trunk lid release button  on the transmitter for longer than 1 second.

## THEFT-ALARM SYSTEM

B070A01A-AAT

This system is designed to provide protection from unauthorized entry into the car. This system is operated in three stages : the first is the "Armed" stage, the second is the "Alarm" stage and the third is the "Disarmed" stage. If triggered, the system provides an audible alarm with blinking of the turn signal lights.

B070B01NF-AAT

## Armed Stage

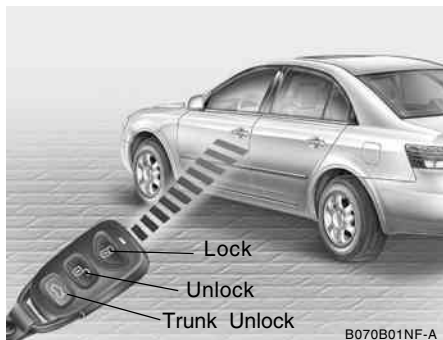

Park the car and stop the engine. Arm the system as described below.

- 1) Remove the ignition key from the ignition switch.

- 2) Make sure that the engine hood and trunk lid are closed and latched.
- 3) Lock the doors using the transmitter of the keyless entry system.

After completion of the steps above, the turn signal lights will blink once to indicate that the system is armed.

**NOTE:**

- 1) If any door, trunk lid or engine hood remains open, the system will not be armed.
- 2) If this happens, rearm the system as previously described.

**NOTE:**

**Do not arm the system until all passengers have left the car. If the system is armed while a passenger(s) remains in the car, the alarm may be activated when the remaining passenger(s) leaves the car.**

B070C01NF-AAT

## Alarm Stage



The alarm will be activated if any of the following occurs while the car is parked and the system is armed.

- 1) A front or rear door is opened without using the transmitter or the ignition key.
- 2) The trunk lid is opened without using the transmitter or the ignition key.
- 3) The engine hood is opened.

The alarming horn will sound and the turn signal lights will blink continuously for 27 seconds (This will repeat 3 times). To turn off the system, unlock the door or trunk lid with the transmitter or the ignition key.

**CAUTION:**

Avoid trying to start the engine while the system is armed.

B070D01NF-AAT

**Disarmed Stage**

The system will be disarmed by using the transmitter or the ignition key.

Only the driver's door is unlocked by depressing once the "UNLOCK (🔓)" button on the transmitter. If you wish to unlock all doors, press the "UNLOCK (🔓)" button on the transmitter again within 4 seconds.

Whenever the step above is completed, the turn signal lights will blink twice to indicate that the system is disarmed.

If any door, trunk lid or engine hood is not opened or the ignition key is not inserted in the ignition switch within 30 seconds, the system will be rearmed.

**NOTE:**

When the system is disarmed while the "DOOR" button of the interior light is depressed, the interior light will illuminate for 30 seconds.

B070E01NF-AAT

**Panic Warning**

B070E02NF-A

1. Push the "PANIC" button on the backside of the transmitter.
2. At the same time, the alarming horn will sound and the turn signal lights will blink continuously for 30 seconds.
3. To turn off the system, push the "PANIC" button again on the backside of the transmitter.

B070E01NF-GAT

**Replacing the battery**

When the transmitter's battery begins to get weak, it may take several pushes on the button to lock or unlock the doors, and the LED will not light. Replace the battery as soon as possible.

Battery type : CR2032

Replacement instructions:



B070E01NF

1. Carefully separate the case with a coin as shown in the illustration.

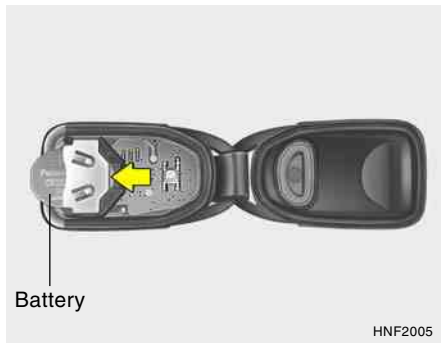

2. Remove the old battery from the case and note the polarity. Make sure the polarity of the new battery is the same (+side facing up), then insert it in the transmitter.

## WINDOWS

B060D01NF-GAT

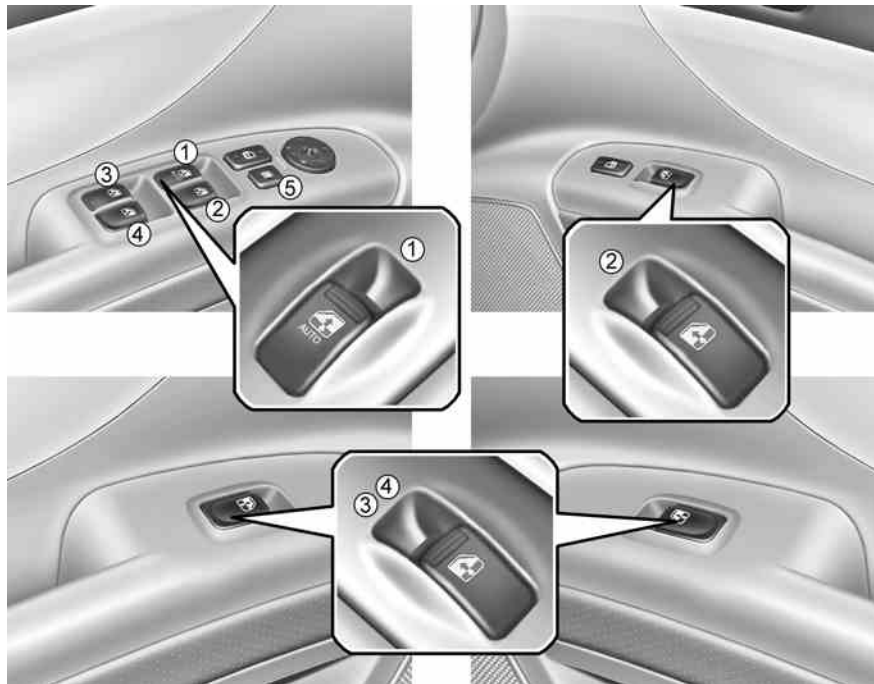

1. Driver's door power window switch
2. Front passenger's door power window switch
3. Rear passenger's door power window switch (left side)
4. Rear passenger's door power window switch (right side)
5. Window lock switch

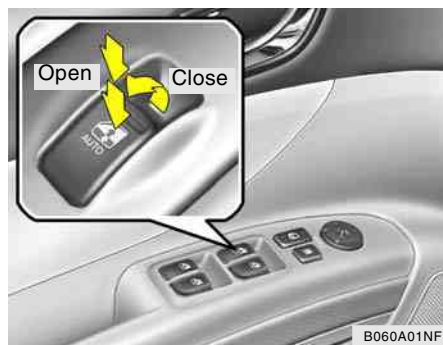

B060A01NF-GAT

**POWER WINDOWS**

The power windows operate when the ignition key is in the "ON" position. The main switches are located on the driver's armrest and control the front and rear windows on both sides of the vehicle. The windows may be opened by depressing the appropriate window switch and closed by pulling up the switch. To open the window on the driver's side, press the switch halfway down. The window moves as long as the switch is operated.

**Auto Up/Down Window (Driver's side)**

The auto up/down window is controlled by the main switch on the driver's armrest.

To fully open the window automatically, press the switch fully down. To fully close the window automatically, pull the switch fully up. In automatic operation, the window will fully open or close even if you let go of the switch. To stop the window at the desired position while the window is in operation, pull up or depress and release the switch to the opposite direction of the movement.

**NOTE:**

**If the battery has been recharged or disconnected, the auto up/down window system must be reset as follows;**

1. Turn the ignition key to "ON" position.
2. Pull up the driver's window switch until the window is fully closed and continue pulling up the driver's window switch for at least 0.2 second.

**If the auto up/down window is not reset, it may not operate properly.**

**Window lock (Driver's side)**

In order to prevent operation of the passenger front and rear windows, a window lock switch is provided on the armrest of the driver's door. To disable the power windows, press the window lock switch. To revert to normal operation, press the window lock switch a second time.

**NOTE:**

The power windows can be operated for 30 seconds after the ignition key is turned to the "ACC" or "LOCK" positions, or removed from the ignition switch.

If the front doors are opened during this 30 second period, the power windows can no longer be operated without the ignition key turned to the "ON" position.

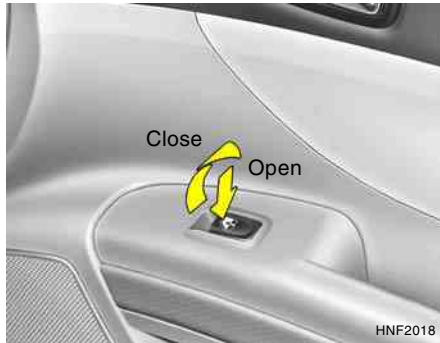

B060C01NF-AAT

### Automatic Reverse Window (Driver's side)

If the upward movement of the window is blocked by an object or part of the body, the window will detect the resistance and will stop upward movement. The window will then lower approximately 11.8 in.(30cm) to allow the object to be cleared.

**WARNING:**

- o The automatic reverse window will only operate when the automatic up window operation feature is used. The automatic reverse feature of the window will not operate if the window is raised using the halfway position on the power window switch.
- o If an object less than 0.16 in.(4 mm) in diameter is caught between the window glass and the upper window channel, the automatic reverse window may not detect the resistance and will not stop and reverse direction. Therefore, always check for any obstructions before raising any window.

**WARNING:**

- o Be careful that someone's head, hands and body are not trapped by a closing window.
- o Never try to operate the main switch on the driver's door and the individual door window switch in opposing directions at the same time. If this is done, the window will stop and cannot be opened or closed.
- o Do not leave children alone in the car.
- o Never leave the ignition key in the car.

## SEATS

B080A01A-AAT

## ADJUSTABLE FRONT SEATS

**WARNING:**

Never attempt to adjust the seat while the vehicle is moving. This could result in loss of control or an accident which may cause death, serious injury, or property damage.

B080B02A-AAT

## Adjusting Seat Forward and Rearward



To move the seat toward the front or rear, pull the lock release lever upward. This will release the seat on its track so you can move it forward or rearward to the desired position. When you find the position you want, release the lever and slide the seat forward or rearward on its track until it locks into the desired position and cannot be moved further.

**WARNING:**

To ensure the seat is locked securely, attempt to move the seat forward or rearward without using the lock release lever.

B080C01A-AAT

## Adjusting Seatback Angle



To recline the seatback, lean forward to take your weight off it, then pull up on the recliner control lever at the outside edge of the seat. Now lean back until the desired seatback angle is achieved. To lock the seatback into position, release the recliner control lever.

**WARNING:**

To minimize risk of severe injury in the event of a collision or a sudden stop, both the driver and passenger seatbacks should always be in an upright position while the vehicle is in motion. The protection provided by the seat belts and airbags may be reduced significantly when the seatbacks are reclined. There is greater risk that the driver and passenger will slide under the seat belt which may result in serious injury if a crash occurs when the seatbacks are reclined.

The seat belt cannot provide full protection to an occupant if the seat back is reclined.

B080D02JM-AAT

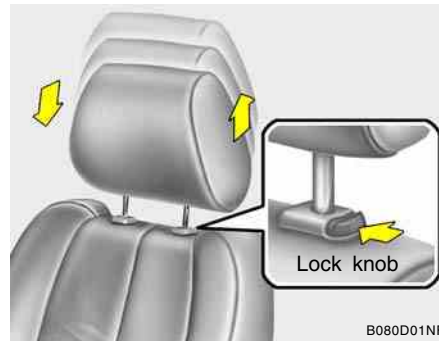
**Adjustable Headrests**

B080D01NF

Headrests are designed to help reduce the risk of neck injuries.

To raise the headrest, pull it up. To lower it, push it down while pressing the lock knob. To remove the headrest, raise it as far as it can go then press the lock knob while pulling upward. This should only be done when the seat is not occupied.

**WARNING:**

B080D01JM

- o For maximum effectiveness in case of an accident the headrest should be adjusted so the middle of the headrest is at the same height as the top of the occupant's eyes. For this reason, the use of a cushion that holds the body away from the seatback is not recommended.
- o Do not operate the vehicle with the headrests removed as injury to the occupants may occur in the event of an accident. Headrests may provide protection against neck injuries when properly adjusted.
- o Do not adjust the headrest height while the vehicle is in motion.

B081D01LZ-AAT

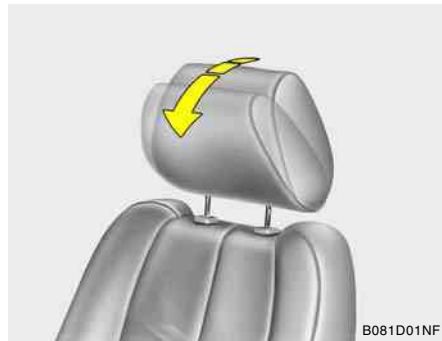
**Tilting Headrest Forward and Rearward**

B081D01NF

The headrest may be tilted forward to three different positions by pulling the headrest forward. To adjust the headrest rearward, pull it fully forward to the farthest position and release it. Adjust the headrest so that it properly supports the head and neck.

B083D01NF-AAT

**Active Headrests (If Installed)**

HNF2041-1

The active headrest is designed to move forward and upward during a rear impact. This helps to prevent the driver's and front passenger's head from moving backward and thus helps prevent neck injuries.

B080E01Y-AAT

**Lumbar Support Control (Driver's Seat Only) (If Installed)**

HNF2039

To adjust the lumbar support, turn the handle on the outboard or left side of the seat. To increase the amount of lumbar support, pull the lever forward. To decrease it, push the lever toward the rear.

1. Minimum support
2. Maximum support

B080F01NF-GAT

### Seat Height Adjustment (Driver's Seat Only)

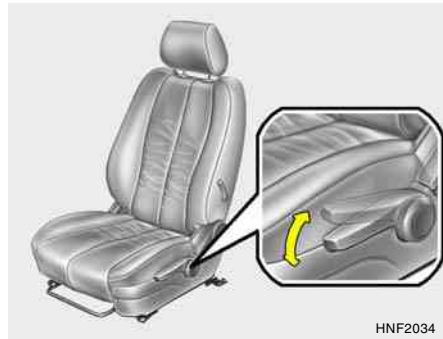

HNF2034

To raise or lower the seat, raise or lower the control lever to the desired seat height.

B090A01Y-AAT

### POWER DRIVER'S SEAT (If Installed)

The driver's seat can be adjusted by using the control knobs on the left side of the seat. Before driving, adjust the seat to the proper position so as to easily control the steering wheel, pedals and switches on the instrument panel.



#### CAUTION:

Do not operate two knobs at the same time.



#### WARNING:

- o Never attempt to adjust the seat while the vehicle is moving. This could result in loss of control or an accident causing death, serious injury, or property damage.
- o Do not sit or lean unnecessarily close to the airbag.

B090B01NF-GAT

### Adjusting Seat Forward and Rearward



HNF2036

Pull the control knob forward or backward to move the seat forward or backward to the desired position. Release the control knob and the seat will remain at that position.

B090C01Y-AAT

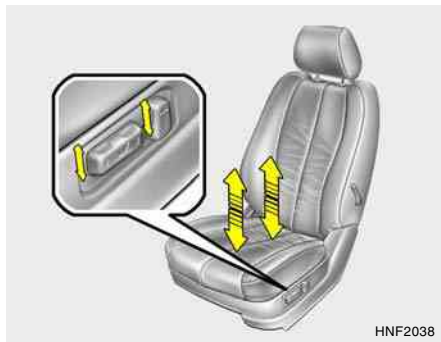
**Seat Cushion Height Adjustment**

Move the front portion of the control knob up or down to raise or lower the front part of the seat cushion. Move the rear portion of the control knob up or down to raise or lower the rear part of the seat cushion.

B090D01NF-GAT

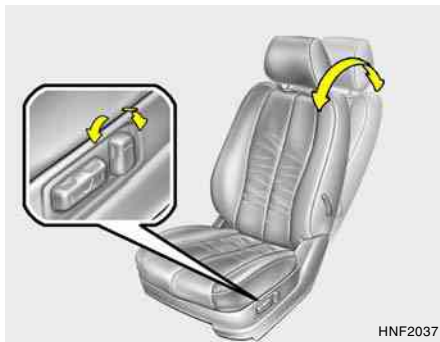
**Adjusting Seatback Angle**

Pull the upper portion of the control knob forward or backward to recline the seatback to the desired position. Release the control knob and the seatback will remain in that position.

**WARNING:**

To minimize the risk of personal injury in the event of a collision or a sudden stop, both the driver's and passenger's seatback should remain in an upright position while the car is in motion. The protection provided by the seat belts and airbags may be reduced significantly when the seatbacks are reclined. There is a greater risk that the seat occupants will slide under the belt resulting in serious injury if a crash occurs when the seatbacks are reclined. The seat belt cannot provide full protection to an occupant if the seatback is reclined.

B100A01NF-AAT

**SEAT WARMER (If Installed)**

B100A01NF

The seat warmer is provided to warm the front seats during cold weather. With the ignition key in the "ON" position, push either of the switches to warm the driver's seat or the front passenger's seat.

During mild weather or under conditions where the operation of the seat warmer is not needed, keep the switches in the "OFF" position.

**NOTE:**

- o The seat warmer may not operate if the ambient temperature is warm.
- o If the seat warmer doesn't operate when the ambient temperature is lower than 75.2°F (24°C), it must be checked at an authorized dealer.

**WARNING:**

Do not turn on the seat warmers, if the seat is occupied by someone who cannot monitor the temperature and turn off the seat warmer, if it becomes too warm. The seat warmers should not be turned on when children, the elderly, ill people, and sleeping people occupy the seat.

B110A01NF-GAT

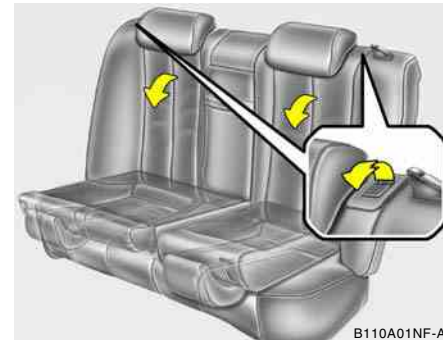
**FOLDING REAR SEATBACKS**

B110A01NF-A

- o To unlock the seatback, pull the seatback release lever, then pull forward on the seatback panel.
- o When you return the seatback to its upright position, always be sure it has locked into position by pulling and pushing on the top of the seatback.



**WARNING:**

The purpose of the folding rear seatbacks is to allow you to carry longer objects than could otherwise be accommodated. Do not allow passengers to sit on top of the folded down seatback, while the car is moving as this is not a proper seating position and no seat belts are available for use. This could result in serious injury or death in case of an accident or sudden stop. Objects carried on the folded down seatback should not extend higher than the top of the front seats. This could allow cargo to slide forward and cause injury or damage during sudden stops.

B120A01NF-GAT

**REAR SEATBACK SAFETY LOCK**

If the rear seatback lock knob (located on the backside of the rear seatback) is in the "LOCK" position when the rear seatbacks are upright and closed, it will not be possible to fold the rear seatback by using the seatback release lever. In this instance, move the lock knob to the "UNLOCK" position and fold the rear seatback. The rear seatback lock knob is designed to provide protection from unauthorized entry into the trunk.



B140A01S-AAT

**REAR SEAT WARNING**

For the safety of all passengers, luggage or other cargo should not be piled higher than the top of the seatback. In addition, do not place objects on the rear shelf as they may move forward during braking or in an accident and may strike and injure vehicle passengers.

## SEAT BELTS

B150A01S-AAT

## SEAT BELT PRECAUTIONS

**WARNING:**

All occupants of the vehicle must wear their seat belts at all times. Note that this vehicle is equipped with a Supplemental Restraint (Airbag) System as discussed beginning on page 1-36. The seat belts must be used in conjunction with the supplemental airbag system. State laws require that some or all occupants of the vehicle use seat belts. The possibility of increased injury or severity of injury in an accident will be increased if this elementary safety precaution is not observed. In addition, follow the other instructions provided in this section.

B150B03Y-AAT

## Infant or Small Child

All 50 states have child restraint laws. You should be aware of the specific requirements in your state. Child and/or infant safety seats must be properly placed and installed in the rear seat. Information about the use of these restraints begins on page 1-28.

**WARNING:**

Every person in your vehicle needs to be properly restrained at all times, including infants and children. In a collision, an unrestrained child can become a "missile" inside the car. The force required to hold a child on your lap could be so great that you could not hold the child. Any child riding in the vehicle should always be in a proper restraint in the rear seat of the vehicle.

**NOTE:**

Small children are best protected from injury in an accident when properly restrained in the rear seat by a child restraint system that meets the requirements of the Federal Motor Vehicle Safety Standards. Before buying any child restraint system, make sure that it has a label certifying that it meets Federal Motor Vehicle Safety Standard 213. The restraint must be appropriate for your child's height and weight. Check the label on the child restraint for this information. See page 1-28.

B150C02A-AAT

## Larger Children

Children who are too large for child restraint systems should always occupy the rear seat and use the available lap/shoulder belts. The lap portion should be fastened snug on the hips and as low as possible. Check belt fit periodically. A child's squirming could put the belt out of position. Children are afforded the most safety in the event of an accident when they are restrained by a proper restraint system in the rear seat. If a larger child (over age 13) must be seated in the front seat, the child should be securely restrained by the available lap/shoulder belt and the seat should be placed in the rearmost position. Children under the age of 13 should be restrained securely in the rear seat. NEVER place a child under the age of 13 in the front seat. NEVER place a rear facing child seat in the front seat of a vehicle.

B150D01A-AAT

## Pregnant Women

The use of a seat belt is recommended for pregnant women to lessen the chance of injury in an accident. When a seat belt is used, the lap belt portion should be placed as low and snugly as possible on the hips, not across the abdomen. For specific recommendations, consult a physician.

B150E01A-AAT

**Injured Person**

A seat belt should be used when an injured person is being transported. When this is necessary, you should consult a physician for recommendations.

B150F01A-AAT

**One Person Per Belt**

Two people (including children) should never attempt to use a single seat belt. This could increase the severity of injuries in case of an accident.

B150G01A-AAT

**Do Not Lie Down**

To reduce the chance of injuries in the event of an accident and to achieve maximum effectiveness of the restraint system, all passengers should be sitting up and the front seats should be in an upright position when the car is moving. A seat belt cannot provide proper protection if the person is lying down in the rear seat or if the front seat is in a reclined position.



**WARNING:**  
**Sitting in a reclined position or lying down when your vehicle is in motion can be dangerous. Even if you buckle up, your seat belts can't do their job when you're reclined.**  
**The shoulder belt can't do its job because it won't be against your body. Instead, it will be in front of you. In a crash, you could go into it with great force, receiving serious neck or other injuries.**  
**The lap belt can't do its job either. In a crash, the belt could go up over your abdomen. The belt forces would be applied there, not at your strong pelvic bones. This could cause serious internal injuries. For proper protection when the vehicle is in motion, have the seatback upright. Then sit back in the seat and wear your seat belt properly. See page 1-24.**

B160A01A-AAT

**CARE OF SEAT BELTS**

Seat belt systems should never be disassembled or modified. In addition, care should be taken to assure that seat belts and belt hardware are not damaged by seat hinges, doors or other abuse.

**WARNING:**

**When you return the rear seatback to its upright position after the rear seatback was folded down, be careful not to damage the seat belt webbing or buckle. Be sure that the webbing or buckle does not get caught or pinched in the rear seat.**

B160B01A-AAT

**Periodic Inspection**

It is recommended that all seat belts be inspected periodically for wear or damage of any kind. Parts of the system that are damaged should be replaced as soon as possible.

B160C01A-AAT

### Keep Belts Clean and Dry

Seat belts should be kept clean and dry. If belts become dirty, they can be cleaned by using a mild soap solution and warm water. Bleach, dye, strong detergents or abrasives should not be used because they may damage and weaken the fabric.

B160D01A-AAT

### When to Replace Seat Belts

Entire in-use seat belt assembly or assemblies should be replaced if the vehicle has been involved in an accident. This should be done even if no damage is visible. Additional questions concerning seat belt operation should be directed to your Hyundai Dealer.

B170A01NF-GAT

### HEIGHT ADJUSTABLE FRONT SEAT SHOULDER BELT

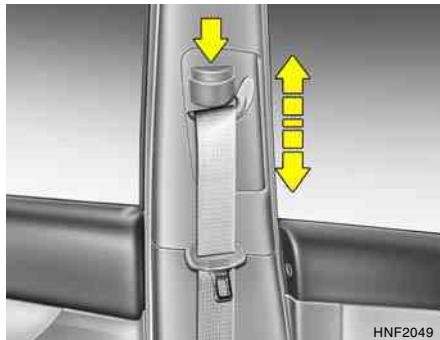

You can adjust the height of the shoulder belt anchor to one of 3 positions for maximum comfort and safety.

If the height of the adjusting seat belt is too near your neck, you will not be getting the most effective protection. The shoulder portion should be adjusted so that it lies across your chest and midway over your shoulder nearest the door and not your neck.

To adjust the height of the seat belt anchor, lower or raise the height adjuster into an appropriate position.

To raise the height adjuster, pull it up. To lower it, push it down while pressing the height adjuster button.

Release the button to lock the anchor into position. Try sliding the height adjuster to make sure that it has locked into position.

**!** **WARNING:**

- o The height adjuster must be in the locked position when the vehicle is moving.
- o The misadjustment of height of the shoulder belt could reduce the effectiveness of the seat belt in a crash.

B180A01NF-AAT

### SEAT BELT-Driver's 3-Point System with Emergency Locking Retractor To Fasten Your Belt



To fasten your seat belt, pull it out of the retractor and insert the metal tab into the buckle. There will be an audible "click" when the tab locks into the buckle.

The seat belt automatically adjusts to the proper length only after the lap belt portion is adjusted manually so that it fits snugly around your hips. If you lean forward in a slow, easy motion, the belt will extend and let you move around. If there is a sudden stop or impact, however, the belt will lock into position. It will also lock if you try to lean forward too quickly.

#### NOTE:

If the driver's seat belt is not fastened when the ignition key is turned from the "OFF" position to the "ON" or "START" position, the seat belt warning light will blink and the warning chime will sound for approximately six seconds to remind the driver to fasten the driver's seat belt.

B190A01NF-AAT

### SEAT BELTS-Front Passenger and Rear Seat 3-Point System with Combination Locking Retractor To Fasten Your Belt

Combination retractor type seat belts are installed in the rear seat positions to help accommodate the installation of child restraint systems. Although a combination retractor is also installed in the front passenger seat position, Hyundai strongly recommends that children always be seated in the rear seat. NEVER place any infant restraint system in the front seat of the vehicle. This type of seat belt combines the features of both an emergency locking retractor seat belt and an automatic locking retractor seat belt. To fasten your seat belt, pull it out of the retractor and insert the metal tab into the buckle. There will be an audible "click" when the tab locks into the buckle. When not securing a child restraint, the seat belt operates in the same way as the driver's seat belt (Emergency Locking Retractor Type). It automatically adjusts to the proper length only after the lap belt portion of the seat belt is adjusted manually so that it fits snugly around your hips. When the seat belt is fully extended from the retractor to allow the installation of a child restraint system, the seat belt operation changes to allow the belt to retract, but not to extend (Automatic Locking Retractor Type). See page 1-32.

**NOTE:**

- o Although the combination retractor provides the same level of protection for seated passengers in either emergency or automatic locking modes, it is recommended that seated passengers use the emergency locking feature for improved convenience. The automatic locking function is intended to facilitate child restraint installation. To convert from the automatic locking feature to the emergency locking operation mode, allow the unbuckled seat belt to fully retract.
- o The front passenger's seat belt warning light on the center fascia panel blinks until the front passenger's seat belt is fastened to remind the front passenger to fasten the front passenger's seat belt, when the ignition key is turned from the "OFF" position to "the "ON" or "START" position.

**WARNING:**

- o For maximum restraint system protection, the seat belts must always be used whenever the car is moving.
- o Seat belts are most effective when seatbacks are in the upright position.
- o Children must always be seatbelted in the rear seats. Never allow children to ride in the front passenger seat.
- o The shoulder belt should be positioned midway over the shoulder nearest the door for the most effective protection. Never wear the seat belt under the arm nearest the door. Wearing the belt under the arm nearest the door could cause serious or fatal injuries in an accident.
- o Avoid wearing twisted seat belts. A twisted belt can't do its job as well. In a collision, it could even cut into you. Be sure the belt webbing is straight and not twisted.
- o Be careful not to damage the belt webbing or hardware. If the belt webbing or hardware is damaged, replace it.

B200A01A-AAT

**Adjusting Your Seat Belt**

B200A01NF

**WARNING:**

You should place the lap belt portion as low as possible and snugly across your hips, not on your waist. If the lap belt is located too high on your waist, it may increase the chance of injury in the event of a collision. Both arms should not be under or over the belt. Rather, one should be over and the other under, as shown in the illustration. Never wear the seat belt under the arm nearest the door.

B210A01A-AAT

### To Release the Seat Belt

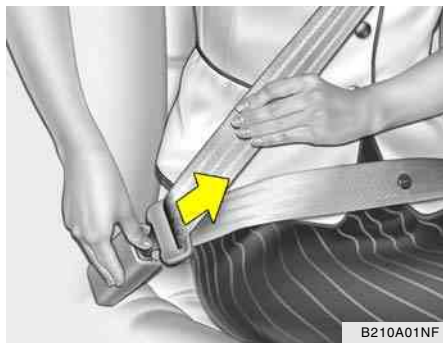

The seat belt is released by pressing the release button in the locking buckle. When it is released, the belt should automatically draw back into the retractor.

If this does not happen, check the belt to be sure it is not twisted, then try again.

B200A01NF-AAT

### SEAT BELTS - Rear Seat Center 3-Point System With Combination Locking Retractor



1. Pull the seat belt out of the rear seat package tray.
2. Before fastening the rear seat center belt, confirm the metal tab (a) and buckle (b) are latched together.

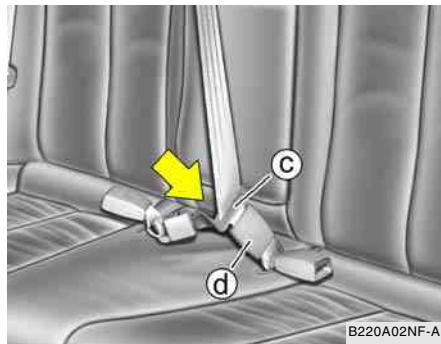

3. After confirming that (a) and (b) are latched, pull the seat belt out of the retractor and insert the metal tab (c) into the buckle (d).

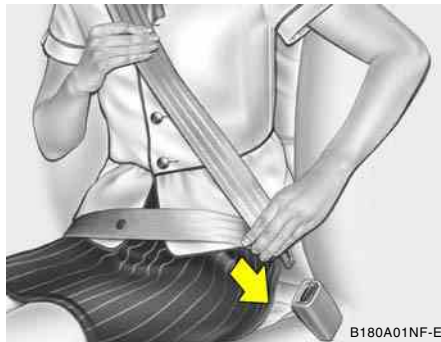

B180A01NF-E

There will be an audible "click" when the tab locks in the buckle. The seat belt automatically adjusts to the proper length only after the lap belt is adjusted manually so that it fits snugly around your hips. If you lean forward in a slow, easy motion, the belt will extend and let you move around. If there is a sudden stop or impact, the belt will lock into position. It will also lock if you try to lean forward too quickly.

**WARNING:**

- o When using the rear seat center belt, you must lock all metal tabs and buckles. If any metal tab or buckle is not locked, it will increase the chance of injury in the event of collision.
- o Never unlock the metal tab (a) and the buckle (b) with the following exceptions.
  - (1) In case of folding rear seatbacks down.
  - (2) If transporting an object on the rear seat may cause damage to the rear seat center belt.

**WARNING:**

- o Lock the metal tab (a) and the buckle (b) immediately after folding rear seatbacks up.

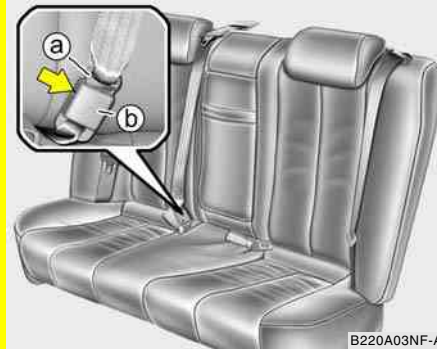

B220A03NF-A

- o To disconnect the metal tab (a) from the buckle (b), insert a narrow-ended tool into the groove located on the buckle (b).



## CHILD RESTRAINT SYSTEM

B220C02A-GAT

## To Release the Seat Belt



When you want to release the seat belt, press the button in the locking buckle.

**WARNING:**

When fastening the outboard seat belts or the center seat belt, make sure they are inserted into the correct buckles to obtain maximum protection from the seat belt system and assure proper operation.

B230A03Y-AAT

Children riding in the car should sit in the rear seat and must always be properly restrained to minimize the risk of injury in an accident, sudden stop or sudden maneuver. According to accident statistics provided by the National Highway Traffic Safety Administration (NHTSA), children are safer when properly restrained in the rear seats than in the front seat. Larger children not in a child restraint should use one of the seat belts provided.

All 50 states have child restraint laws. You should be aware of the specific requirements in your state. Child and/or infant safety seats must be properly placed and installed in the rear seat. You must use a commercially available child restraint system that meets the requirements of the Federal Motor Vehicle Safety Standards (FMVSS).

Children could be injured or killed in a crash if their restraints are not properly secured. For small children and babies, a child seat or infant seat must be used. Before buying a particular child restraint system, make sure it fits your car seat and seat belts, and fits your child. Follow all the instructions provided by the manufacturer when installing the child restraint system.

**WARNING:**

- o A child restraint system must be placed in the rear seat. Never install a child or infant seat on the front passenger's seat. Should an accident occur and cause the passenger side airbag to deploy, it could severely injure or kill an infant or child seated in an infant or child seat. Thus only use a child restraint in the rear seat of your vehicle.
- o A safety belt or child restraint system can become very hot if it is left in a closed vehicle on a sunny day, even if the outside temperature does not feel hot. Be sure to check the seat cover and buckles before placing a child there.
- o When the child restraint system is not in use, store it in the trunk or fasten it with a safety belt so that it will not be thrown forward in the case of a sudden stop or an accident.
- o Children who are too large to be in a child restraint should sit in the rear seat and be restrained with the available lap/shoulder belts. Never allow children to ride in the front passenger seat.

**WARNING:**

- o Always make sure that the shoulder belt portion of the lap/shoulder belt is positioned midway over the shoulder and never across the neck or behind the back. Moving the child closer toward the seat belt buckle may help provide a good shoulder belt fit. The lap belt portion of the lap/shoulder belt must always be positioned as low as possible on the child's hips, and as snug as possible.
- o If the seat belt will not properly fit the child, Hyundai recommends the use of an approved booster seat in the rear seat in order to raise the child's seating height so that the seat belt will properly fit the child.  
Before purchasing a booster seat, make sure that it meets applicable Federal Motor Vehicle Safety Standards (FMVSS) and that it is satisfactory for use with this vehicle.
- o Never allow a child to stand up or kneel on the seat.
- o Never use an infant carrier or a child safety seat that "hooks" over a seatback; it may not provide adequate security in an accident.

**WARNING:**

- o Never allow a child to be held in a person's arms while they are in a moving vehicle, as this could result in serious injury to the child in the event of an accident or a sudden stop. Holding a child in a moving vehicle does not provide the child with any means of protection during an accident, even if the person holding the child is wearing a seat belt.

B230B01NF-AAT

**Using a Child Restraint System**

For small children and babies, the use of a child seat or infant seat is required. This child seat or infant seat should be of appropriate size for the child and should be installed in accordance with the manufacturer's instructions. It is further required that the seat be placed in the vehicle's rear seat. Your vehicle is provided with three child restraint hook holders for installing the child seat or infant seat.

B230C04A-AAT

## Installing a Child Restraint Seat with the "Tether Anchorage" System

Three child restraint hook holders are located on the rear seat package tray.

### To install the child restraint seat



1. Open the tether anchor cover on the rear seat package tray.

### Rear seat package tray

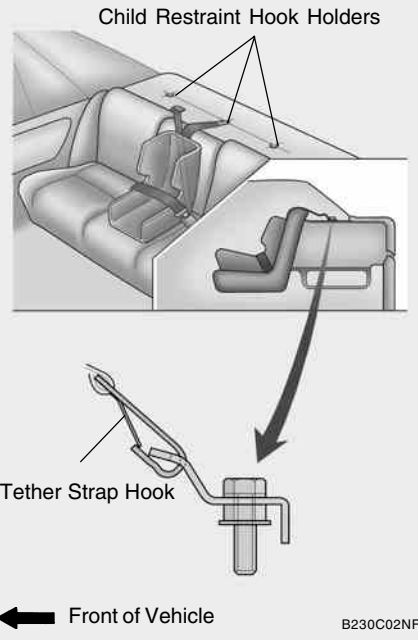

2. Route the child restraint seat tether strap over the seatback.

- For vehicles with adjustable headrests, route the tether strap under the headrest and between the headrest posts, otherwise route the tether strap over the top of the seatback.
3. Connect the tether strap hook to the child restraint hook holder and tighten to secure the seat.

**!** **WARNING:**  
 Do not mount more than one child restraint to a single tether or to a child restraint lower anchorage point. The improper increased load may cause the anchorage points or tether anchor to break, causing serious injury or death.

B230D03E-AAT

## Securing the Child Restraint Seat with the "ISOFIX" system

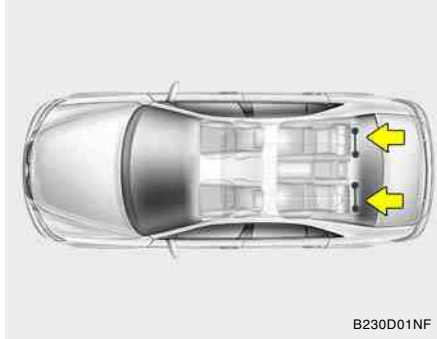

B230D01NF

Some child seat manufacturers make safety seats that are labeled as ISOFIX or ISOFIX-compatible child seats. These seats include two rigid or webbing mounted attachments that connect to two ISOFIX anchors at specific seating positions in your vehicle. This type of child seat eliminates the need to use seat belts to attach the child seat for forward-facing child seats.

ISOFIX anchors have been provided in your vehicle. The ISOFIX anchors are located in the left and right outboard rear seating positions. Their locations are shown in the illustration. There is no ISOFIX anchor provided for the center rear seating position.



### WARNING:

- o Do not install a child restraint seat at the center of the rear seat using the vehicle's ISOFIX anchors. The ISOFIX anchors are only provided for the left and right outboard rear seating positions. Do not misuse the ISOFIX anchors by attempting to attach a child safety seat in the middle of the rear seat position to the ISOFIX anchors. In a crash, the child seat ISOFIX attachments may not be strong enough to secure the child restraint seat properly in the center of the rear seat and may break, causing serious injury or death.
- o Do not mount more than one child restraint to a single tether or to a child restraint lower anchorage point. The improper increased load may cause the anchorage points or tether anchor to break, causing serious injury or death.
- o Attach the ISOFIX or ISOFIX-compatible child seat only to the appropriate locations shown.
- o Always follow the installation and use instructions provided by the manufacturer of the child restraint.

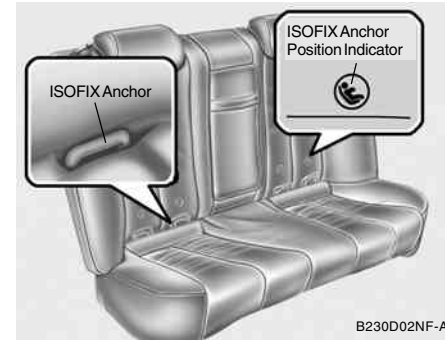

B230D02NF-A

The ISOFIX anchors are located between the seatback and the seat cushion of the rear seat left and right outboard seating positions.

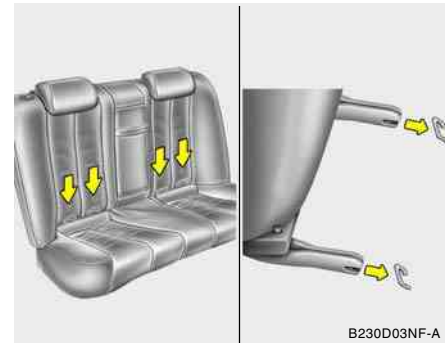

B230D03NF-A

Follow the child seat manufacturer's instructions to properly install safety seats with ISOFIX or ISOFIX-compatible attachments.

Once you have installed the ISOFIX child restraint seat, assure that the seat is properly attached to the ISOFIX and tether anchors. Also, test the safety seat before you place the child in it. Tilt the seat from side to side. Also try to tug the seat forward. Check to see if the anchors hold the seat in place.



**WARNING:**

If the child restraint seat is not anchored properly, the risk of a child being seriously injured or killed in a collision greatly increases.

B230G03Y-AAT

**Installation on Rear Seats**

On rear seat center position



On outboard rear seats

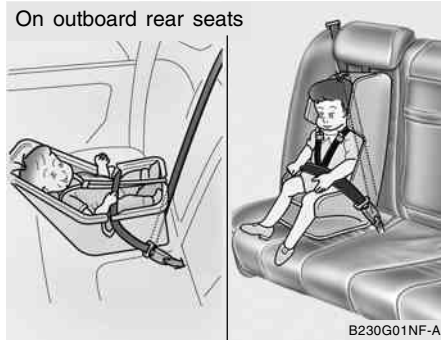

To install a child restraint system in the rear seats, extend the shoulder/lap belt entirely from its retractor until a "click" is felt. This will engage the seat belt retractor automatic locking feature, which allows the seat belt to retract but not extend. Install the child restraint system, buckle the seat belt and allow the seat belt to take up any slack. Make sure that the lap portion of the belt is tight around the child restraint system and the shoulder portion of the belt is positioned so that it cannot interfere with the child's head or neck. Also, double check to be sure that the retractor has engaged the Automatic Locking feature by trying to extend webbing out of the retractor. If the retractor is in the Automatic Locking mode, the belt will be locked. After installation of the child restraint system, try to move it in all directions to be sure the child restraint system is securely installed. If you need to tighten the belt, pull more webbing toward the retractor. When you unbuckle the seat belt and allow it to retract, the retractor will automatically revert back to its normal seated passenger Emergency Locking usage condition.

**NOTE:**

- o Before installing the child restraint system in any seating position, read the instructions supplied by the child restraint system manufacturer.
- o If the seat belt does not operate as described, have the system checked immediately by your authorized Hyundai dealer.

**WARNING:**

- o If the retractor is not in the Automatic Locking mode, the child restraint system can move when your vehicle turns or stops abruptly.
- o Do not install any child restraint system in the front passenger seat. Should an accident occur and cause the passenger side airbag to deploy, it could severely injure or kill an infant or child seated in an infant or child seat. Therefore, only use a child restraint system in the rear seat of your vehicle.

B180B01NF-AAT

**Pre-tensioner Seat Belt**

HXG229

Your Hyundai vehicle is equipped with driver's and front passenger's pre-tensioner seat belts. The purpose of the pre-tensioner is to make sure that the seat belts fit tightly against the occupant's body in certain frontal collisions. The pre-tensioner seat belts can be activated alone or, where the frontal collision is severe enough, together with the airbags.

When the vehicle stops suddenly, or if the occupant tries to lean forward too quickly, the seat belt retractor will lock into position. In certain frontal collisions, the pre-tensioner will activate and pull the seat belt into tighter contact against the occupant's body. The buckle pre-

tensioner (which is installed in the buckle) will also pull the seat belt into the buckle.

**CAUTION:**

**Do not put anything near the buckle. Placing objects near the buckle can adversely affect the buckle pre-tensioner and may increase the risk of personal injury in the event of a collision.**

If the system senses excessive seat belt tension on the driver or passenger's seat belt when the pre-tensioner activates, the load limiter inside the pre-tensioner will release some of the pressure on the affected seat belt.

The seat belt pre-tensioner system consists mainly of the following components. Their locations are shown in the illustration:

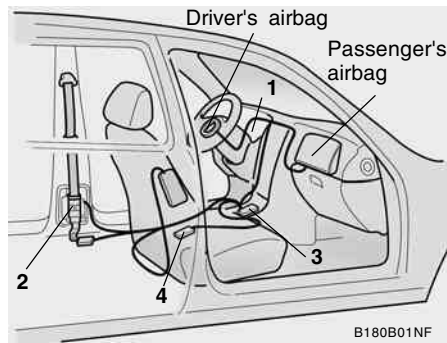

1. SRS airbag warning light
2. Retractor pre-tensioner assembly
3. SRS control module
4. Buckle pre-tensioner assembly

**WARNING:**

To obtain maximum benefit from a pre-tensioner seat belt:

1. The seat belt must be worn correctly.
2. The seat belt must be adjusted to the correct position.
3. Be sure you and your passengers always wear seat belts and wear them properly.

**NOTE:**

- o Both the driver's and front passenger's pre-tensioner seat belts will be activated in certain frontal collisions. The pre-tensioner seat belts can be activated alone or, where the frontal collision is severe enough, together with the airbags.

The pre-tensioners will not be activated if the seat belts are not being worn at the time of the collision.

- o When the pre-tensioner seat belts are activated, a loud noise may be heard and fine dust, which may appear to be smoke, may be visible in the passenger compartment. These are normal operating conditions and are not hazardous.
- o Although it is harmless, the fine dust may cause skin irritation and should not be breathed for prolonged periods. Wash all exposed skin areas thoroughly after an accident in which the pre-tensioner seat belts were activated.

**CAUTION:**

- o Because the sensor that activates the SRS airbag is connected with the pre-tensioner seat belt, the SRS airbag warning light  on the instrument panel will illuminate for approximately 6 seconds after the ignition key has been turned to the "ON" position, and then it should turn off.
- o If the pre-tensioner seat belt is not working properly, this warning light will illuminate even if there is no malfunction of the SRS airbag. If the SRS airbag warning light does not illuminate when the ignition key is turned to "ON", or if it blinks for a second and remains illuminated after illuminating for approximately 6 seconds, or if it illuminates while the vehicle is being driven, please have an authorized Hyundai dealer inspect the pre-tensioner seat belt or SRS airbag system as soon as possible.

**WARNING:**

- o Pre-tensioners are designed to operate only one time. After activation, pre-tensioner seat belts must be replaced. All seat belts, of any type, should always be replaced after they have been worn during a collision.
- o The pre-tensioner seat belt assembly mechanisms become hot during activation. Do not touch the pre-tensioner seat belt assemblies for several minutes after they have been activated.
- o Do not attempt to inspect or replace the pre-tensioner seat belts yourself. This must be done by an authorized Hyundai dealer.
- o Do not strike the pre-tensioner seat belt assemblies.
- o Do not attempt to service or repair the pre-tensioner seat belt system in any manner.
- o Improper handling of the pre-tensioner seat belt assemblies, and failure to heed the warnings not to strike, modify, inspect, replace, service or repair the pre-tensioner seat belt assemblies may lead to improper operation or inadvertent activation and serious injury.
- o Always wear the seat belts when driving or riding in a motor vehicle.



36 **ADVANCED SUPPLEMENTAL RESTRAINT (AIRBAG) SYSTEM (SRS)**

B240D01NF-AAT

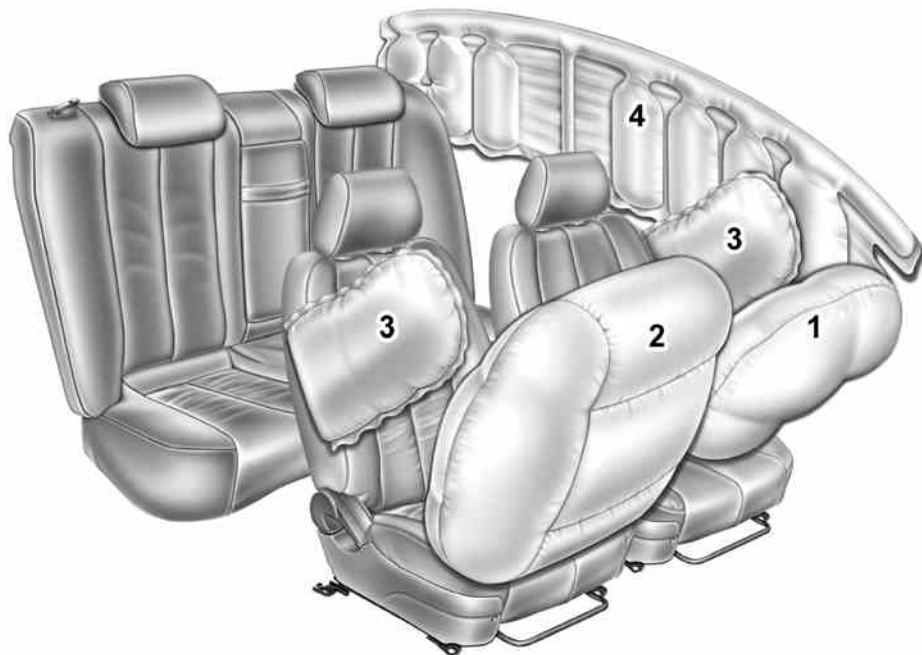

1. Driver's front airbag
2. Passenger's front airbag
3. Side impact airbag
4. Curtain airbag

B240A01NF-AAT

**Driver's and Passenger's Front Airbag****Driver's Front Airbag**

Your Hyundai is equipped with an advanced Supplemental Restraint (Airbag) System. The indications of the system's presence are the letters "SRS AIRBAG" embossed on the airbag pad cover in the steering wheel and the passenger's side front panel pad above the glove box.

The Hyundai SRS consists of airbags installed under the pad covers in the center of the steering wheel and the passenger's side front panel above the glove box. The purpose of the SRS is to provide the vehicle's driver and/or the front passenger with additional protection than that offered by the seat belt system alone in case of a frontal impact of sufficient severity.

The SRS uses sensors to gather information about the driver's and front passenger's seat position, the driver's and front passenger's seat belt usage and impact severity.

The driver's and front passenger's seat track position sensors, which are installed on the seat track, determine if the seats are fore or aft of a reference position. The seat belt buckle sensors determine if the driver and front passenger's seat belts are fastened. These sensors provide the ability to control the SRS deployment based on how close the driver's seat is to the steering wheel, how close the passenger's seat is to the instrument panel, whether or not the seat belts are fastened, and how severe the impact is.

The advanced SRS offers the ability to control the airbag inflation with two levels. A first stage level is provided for moderate-severity impacts. A second stage level is provided for more severe impacts.

According to the impact severity, seating position and seat belt usage, the SRSCM (SRS Control Module) controls the airbag inflation. Failure to properly wear seat belts can increase the risk or severity of injury in an accident.

Additionally, your Hyundai is equipped with an occupant classification system in the front passenger's seat. The occupant classification system detects the presence of a passenger in the front passenger's seat and will turn off the front passenger's airbag under certain conditions. For more detail, see "Occupant Classification System" later in this section.

**CAUTION:**

**If a seat track position sensor or an occupant classification system is not working properly, the SRS airbag warning light  on the instrument panel will illuminate because the SRS airbag warning light is connected with the seat track position sensor and the occupant classification system. If the SRS airbag warning light does not illuminate when the ignition key is turned to the "ON" position, remains illuminated after approximately 6 seconds when the ignition key is turned to the "ON" position, or if it illuminates while the vehicle is being driven, have an authorized Hyundai dealer inspect the advanced SRS airbag system as soon as possible.**

**WARNING:**

- o Modification to the seat structure can adversely affect the seat track position sensor and cause the airbag to deploy at a different level than should be provided.
- o Do not place any objects underneath the front seats as they could damage the seat track position sensor or interfere with the occupant classification system.
- o Do not place any objects that may cause magnetic fields near the front seat. These may cause a malfunction of the seat track position sensor.

**NOTE:**

- o Be sure to read information about the SRS on the labels provided on the backside of the sun visor and in the glove box.
- o Advanced airbags are combined with pre-tensioner seat belts to help provide enhanced occupant protection in frontal crashes. Front airbags are not intended to deploy in collisions in which sufficient protection can be provided by the pre-tensioner seat belt.
- o If you are considering modification of your vehicle due to a disability, please contact the Hyundai Customer Assistance Center at 1-800-633-5151.

**WARNING:**

- o As its name implies, the SRS is designed to work with, and be supplemental to the driver's and the passenger's three point seat belt systems and is not a substitute for them. Therefore, your seat belts must be worn at all times. The airbags deploy only in certain frontal impact conditions severe enough to cause significant injury to the vehicle occupants.
- o Sitting too close to a front airbag can result in serious or fatal injury if the front airbags inflate. Always sit as far back from airbags as possible.
- o Ignoring the SRS airbag warning light can result in serious or fatal injury if the airbags, occupant classification system or pre-tensioners do not work properly. Have your car checked by a dealer as soon as possible if the SRS airbag warning light alerts you to a potential problem.
- o The SRS is designed to deploy the front airbags only when an impact is sufficiently severe and when the impact angle is less than 30° from the forward longitudinal axis of the vehicle. The front airbags will not deploy in side, rear or rollover impacts. Additionally, the airbags will only deploy once. Seat belts must be worn at all times.

**WARNING:**

- o Front airbags are not intended to deploy in side-impact, rear-impact or rollover crashes. In addition, front airbags will not deploy in frontal crashes below the deployment threshold.

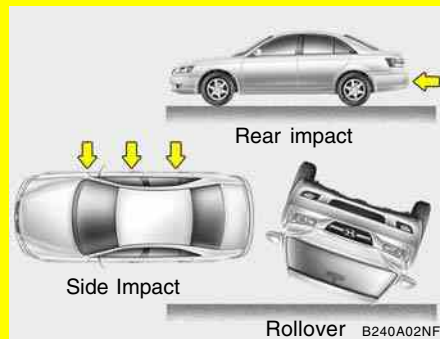

- o The driver should sit back as far as possible while still maintaining control of the vehicle. If you are sitting too close to the airbag, it can cause death or serious injury when it inflates.

**WARNING:**

- o No objects should be placed over or near the airbag modules on the steering wheel, instrument panel, and the front passenger's panel above the glove box, because any such object could cause harm if the vehicle is in a crash severe enough to cause the airbags to deploy.
- o If the airbags deploy, they must be replaced by an authorized Hyundai dealer.
- o Do not tamper with or disconnect SRS wiring or other components of the SRS system. Doing so could result in injury, due to accidental deployment of the airbags or by rendering the SRS inoperative.
- o Even though your vehicle is equipped with the occupant classification system, do not install a child restraint system in the front passenger seat position. A child restraint system must never be placed in the front seat. The infant or child could be severely injured or killed by an airbag deployment in case of an accident.

**WARNING:**

- o Do not allow children to ride in the front passenger seat. If older children (teenagers and older) must ride in the front seat, make sure they are always properly belted and the seat is moved back as far as possible.
- o For maximum safety protection in all types of crashes, all occupants including the driver should always wear their seat belts whether or not an airbag is also provided at their seating position to minimize the risk of severe injury or death in the event of a crash. Do not sit or lean unnecessarily close to the airbag while the vehicle is in motion.
- o Sitting improperly or out of position can result in serious or fatal injury in a crash. All occupants should sit upright with the seat back in an upright position, centered on the seat cushion with their seat belt on, legs comfortably extended and their feet on the floor until the vehicle is parked and the ignition key is removed.
- o The SRS airbag system must deploy very rapidly to provide protection in a crash. If an occupant is out of position because of not wearing a seat belt, the airbag may forcefully contact the occupant causing serious or fatal injuries.

B240B01NF-AAT

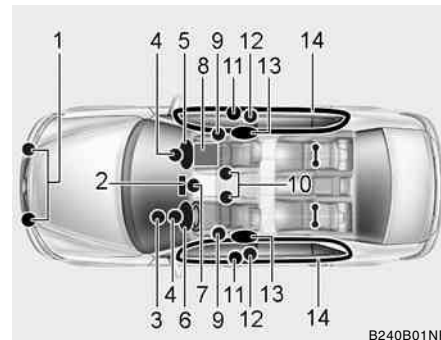
**SRS Components and Functions**

B240B01NF

The SRS consists of the following components:

1. Front Impact Sensor
2. "PASSENGER AIR BAG OFF" Indicator (Front passenger's seat only)
3. SRS "AIRBAG" warning light
4. Knee Bolster
5. Passenger's Airbag Module
6. Driver's Airbag Module
7. SRS Control Module (SRSCM)
8. Occupant Classification System (Front passenger's seat only)
9. Driver's and Front Passenger's Seat Track Position Sensors
10. Driver's and Front Passenger's Seat Belt Buckle Sensors/Buckle Pre-tensioner Assemblies

- 11.Side Impact Sensor
- 12.Retractor Pre-tensioner Assemblies
- 13.Side Impact Airbag Module
- 14.Curtain Airbag Module

The SRSCM continually monitors all elements while the ignition is "ON" to determine if a frontal or near-frontal impact is severe enough to require airbag deployment or pre-tensioner seat belt deployment.

The SRS "AIRBAG" warning light on the instrument panel will illuminate for about 6 seconds after the ignition key is turned to the "ON" position or after the engine is started, after which the "AIRBAG" warning light should go out.



The airbag modules are located both in the center of the steering wheel and in the front passenger's panel above the glove box. When the SRSCM detects a sufficiently severe impact to the front of the vehicle, it will automatically deploy the front airbags.



Upon deployment, tear seams molded directly into the pad covers will separate under pressure from the expansion of the airbags. Further opening of the covers then allows full inflation of the airbags.



A fully inflated airbag, in combination with a properly worn seat belt, slows the driver's or the passenger's forward motion, reducing the risk of head and chest injury.

After complete inflation, the airbag immediately starts deflating, enabling the driver to maintain forward visibility and the ability to steer or operate other controls.

Passenger's Front Airbag



B240B04NF

panel or air ventilator), it may damage these parts. If the liquid from the air freshener does leak onto these areas, wash them with water immediately.

Passenger's Front Airbag



B240B05L

**CAUTION:**

- o Do not install or place any accessories (drink holder, cassette holder, sticker, etc.) on the front passenger's panel above the glove box in a vehicle with a passenger's airbag. Such objects may become dangerous projectiles and cause injury if the passenger's airbag inflates.
- o When installing a container of liquid air freshener inside the vehicle, do not place it near the instrument cluster nor on the instrument panel surface. If there is any leakage from the air freshener onto these areas (instrument cluster, instrument

**WARNING:**

- o When the SRS is activated, there may be a loud noise and fine dust will be released throughout the vehicle. These conditions are normal and are not hazardous. However, the fine dust generated during airbag deployment may cause skin irritation. Wash all exposed skin areas thoroughly with lukewarm water and a mild soap after an accident in which the airbags were deployed.

**WARNING:**

- o The SRS can function only when the ignition key is in the "ON" position. If the SRS "AIRBAG" warning light does not illuminate, or continuously remains on after illuminating for about 6 seconds when the ignition key is turned to the "ON" position, or after the engine is started, comes on while driving, the SRS is not working properly. If this occurs, have your vehicle immediately inspected by your Hyundai dealer.
- o Before you replace a fuse or disconnect a battery terminal, turn the ignition key to the "LOCK" position and remove the ignition key. Never remove or replace the airbag related fuse(s) when the ignition key is in the "ON" position. Failure to heed this warning will cause the SRS "AIRBAG" warning light to illuminate.

**NOTE:**

Your vehicle's Supplemental Restraint System Control Module is equipped a recording device which may record the use of the seat belt restraint system by the driver and front passenger in certain collisions.

B990A01NF-AAT

**OCCUPANT CLASSIFICATION SYSTEM**

Your vehicle is equipped with an occupant classification system in the front passenger's seat.

The Occupant Classification system is designed to detect the presence of a properly-seated front passenger and determine if the passenger's front airbag should be enabled (may inflate) or not. The driver's front airbag is not affected or controlled by the Occupant Classification system.



B990A02NF-A

If the front passenger seat is occupied by a person that the system determines to be of adult size, and he/she sits properly (sitting upright with the seatback in an upright position, centered on the seat cushion with their seat belt on,

legs comfortably extended and their feet on the floor), the "PASSENGER AIR BAG OFF" indicator will be turned off and the front passenger's airbag will be able to inflate, if necessary, in frontal crashes.

You will find the "PASSENGER AIR BAG OFF" indicator on the center facia panel. This system detects the conditions 1~4 in the following table and activates or deactivates front passenger airbags based on these conditions.

**Condition and operation in the front passenger occupant classification system**

Condition detected by the occupant classification system	"Passenger air bag off" indicator light	SRS warning light	Front passenger airbag
1. Adult*1	Off	Off	Activated
2. Child*2 or child restraint system*3	On	Off	Deactivated
3. Unoccupied	On	Off	Deactivated
4. There is a malfunction in the system	Off	On	Activated

- \*1) The system judges a person of adult size as an adult. When a smaller adult sits in the front passenger seat, the system may recognize him/her as a child depending on his/her physique and posture.
- \*2) Do not allow children to ride in the front passenger seat. When a larger child who has outgrown a child restraint system sits in the front passenger seat, the system may recognize him/her as an adult depending on his/her physique or posture.
- \*3) Never install a child restraint system on the front passenger seat.

**!** **WARNING:**

**Do not do any of the following. Placing weight on the front passenger's seat or sitting out-of-correct position adversely affects occupant classification system operation.**

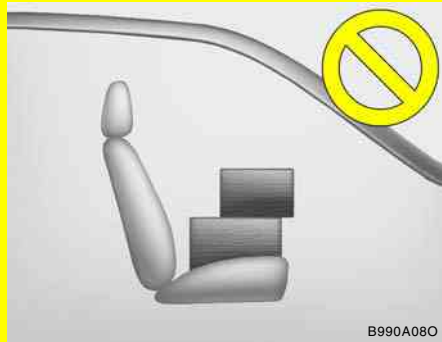

o Put a heavy load in the front passenger seat.



o Sit with hips shifted towards the front of the seat.



- Lean on the center console.
- Sit on one side of the front passenger seat.



o Excessively recline the front passenger seatback.



- Place feet on the dashboard.



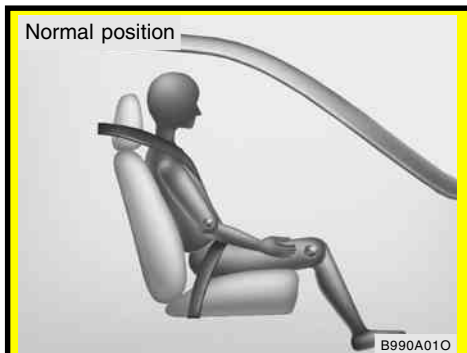

When an adult is seated in the front passenger seat, if the "PASSENGER AIR BAG OFF" indicator is on, turn the ignition key to "LOCK" and ask the passenger to sit properly (sitting upright with the seat back in an upright position, centered on the seat cushion with their seat belt on, legs comfortably extended and their feet on the floor). Restart the engine and have the person remain in that position for about 30 seconds. This will allow the system to detect the person and to enable the passenger airbag. If the "PASSENGER AIR BAG OFF" indicator is still on, turn the ignition key to "LOCK" and ask the passenger to sit properly and restart the engine again. If the "PASSENGER AIR BAG OFF" indicator is still on, ask the passenger to move to the rear seat. After the vehicle starts, the "PASSENGER AIR BAG OFF" indicator will not change according to the passenger's posture.

**NOTE:**

The "PASSENGER AIR BAG OFF" indicator illuminates for about 6 seconds after the ignition key is turned to the "ON" position or after the engine is started. If the front passenger seat is occupied, the occupant classification sensor will then classify the front passenger within approximately 10 seconds after the ignition is turned on.

**CAUTION:**

If the occupant classification system is not working properly, the SRS airbag warning light  on the instrument panel will illuminate because the passenger's front airbags are connected with the occupant classification system. If there is a malfunction of the occupant classification system, the "PASSENGER AIR BAG OFF" indicator will not illuminate and the passenger's front airbags will inflate in frontal impact crashes even if there is no occupant in the front passenger's seat. If the SRS airbag warning light does not illuminate when the ignition key is turned to the "ON" position, remains illuminated after approximately 6 seconds when the ignition key is turned to the "ON" position, or if it illuminates while the vehicle is being driven, have an authorized Hyundai dealer inspect the occupant classification system and the SRS airbag system as soon as possible.

**WARNING:**

- o Even though your vehicle is equipped with the occupant classification system, do not install a child restraint system in the front passenger's seat. A child restraint system must never be placed in the front seat. Children who are too large for child restraint systems should always occupy the rear seat and use the available lap/shoulder belts. Children are afforded the most safety in the event of an accident when they are restrained by a proper restraint system in the rear seat.
- o If the "PASSENGER AIR BAG OFF" indicator is illuminated when the front passenger's seat is occupied by an adult and he/she sits properly (sitting upright with the seatback in an upright position, centered on the seat cushion with their seat belt on, legs comfortably extended and their feet on the floor), have that person sit in the rear seat.
- o If you change the weight on the front passenger seat just after sit-in or restart of the engine, the "PASSENGER AIR BAG OFF" indicator may be turned on or off for a few seconds, disabling or enabling the passenger airbags. After the initial stage of about 30 seconds, the "PASSENGER AIR BAG OFF" indicator will not toggle.

**WARNING:**

- o Do not modify or replace the front passenger seat. Don't place anything on or attach anything such as a blanket or after market seat heater to the front passenger seat. This can adversely affect the occupant classification system.
- o Do not sit on sharp objects such as tools when occupying the front passenger seat. This can adversely affect the occupant classification system.
- o Do not use accessory seat covers on the front seats.
- o Accident statistics show that children are safer if they are restrained in the rear, as opposed to the front seat. It is recommended that child restraints be secured in a rear seat, including an infant riding in a rear-facing infant seat, a child riding in a forward-facing child seat and an older child riding in a booster seat.

**WARNING:**

- o A smaller-stature adult who is not seated correctly (for example: seat excessively reclined, leaning on the center console, or hips shifted forward in the seat) can cause a condition where the advanced frontal airbag system senses less weight than if the occupant were seated properly (sitting upright with the seatback in an upright position, centered on the seat cushion with their seat belt on, legs comfortably extended and their feet on the floor). This condition can result in an adult potentially being misclassified and illumination of the "PASSENGER AIR BAG OFF" indicator.

B990B04Y-AAT

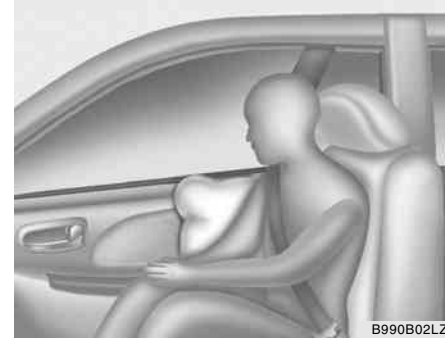
**Side Impact Airbag (If installed)**

B990B02LZ

Your Hyundai is equipped with a side impact airbag in each front seat. The purpose of the airbag is to provide the vehicle's driver and/or the front passenger with additional protection than that offered by the seat belt alone. The side impact airbags are designed to deploy only during certain side-impact collisions, depending on the crash severity, angle, speed and point of impact. The side impact airbags are not designed to deploy in all side impact situations.

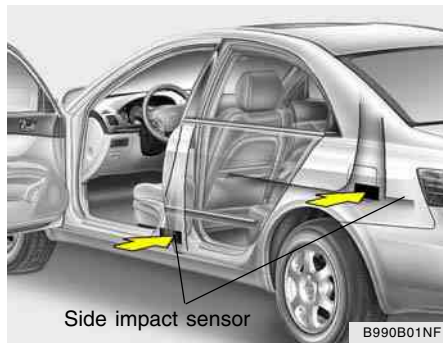

**! WARNING:**

- o The side impact airbag is supplemental to the driver's and the passenger's seat belt systems and is not a substitute for them. Therefore your seat belts must be worn at all times while the vehicle is in motion. The airbags deploy only in certain side impact conditions severe enough to cause significant injury to the vehicle occupants.

**! WARNING:**

- o For best protection from the side impact airbag system and to avoid being injured by the deploying side impact airbag, both front seat occupants should sit in an upright position with the seat belt properly fastened. The driver's hands should be placed on the steering wheel at the 9:00 and 3:00 positions. The passenger's arms and hands should be placed on their laps.
- o Do not use any accessory seat covers.
- o Use of seat covers could reduce or prevent the effectiveness of the system.
- o Do not install any accessories on the side or near the side impact airbag.
- o Do not use excessive force on the side of the seat.
- o Do not place any objects over the airbag or between the airbag and yourself.
- o Do not place any objects (an umbrella, bag, etc.) between the front door and the front seat. Such objects may become dangerous projectiles and cause injury if the supplemental side impact airbag inflates.

**! WARNING:**

- o To prevent unexpected deployment of the side impact airbag that may result in personal injury, avoid impact to the side impact sensor when the ignition key is on.

B990C01LZ-GAT

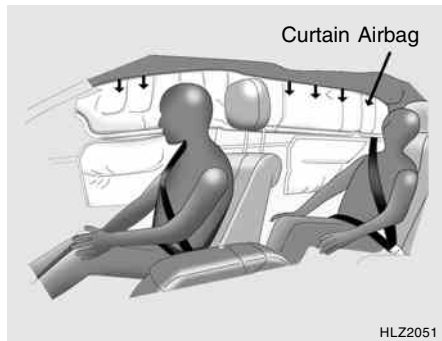
**Curtain Airbag**

Curtain airbags are located along both sides of the roof rails above the front and rear doors. They are designed to help protect the heads of the front seat occupants and the rear outboard seat occupants in certain side impact collisions.

The curtain airbags are designed to deploy only during certain side impact collisions, depending on the crash severity, angle, speed and impact. The curtain airbags are not designed to deploy in all side impact situations, collisions from the front or rear of the vehicle or in most rollover situations.

B240C01NF-AAT

**SRS Care**

The SRS is virtually maintenance-free and so there are no parts you can safely service by yourself. If the SRS "AIRBAG" warning light does not illuminate, or continuously remains on, have your vehicle immediately inspected by your Hyundai dealer.

Any work on the SRS system, such as removing, installing, repairing, or any work on the steering wheel must be performed by a qualified Hyundai technician. Improper handling of the SRS system may result in serious personal injury.

**WARNING:**

- o Do not install a child restraint system in the front passenger seat position. A child restraint system must never be placed in the front seat. The infant or child could be severely injured by an airbag deployment in case of an accident.
- o Modification to SRS components or wiring, including the addition of any kind of badges to the pad covers or modifications to the body structure, can adversely affect SRS performance and lead to possible injury.
- o For cleaning the airbag pad covers, use only a soft, dry cloth or one which has been moistened with plain water. Solvents or cleaners could adversely affect the airbag covers and proper deployment of the system.
- o No objects should be placed over or near the airbag modules on the steering wheel, instrument panel, and the front passenger's panel above the glove box, because any such object could cause harm if the vehicle is in a crash severe enough to cause the airbags to inflate.

**WARNING:**

- If the airbags inflate, they must be replaced by an authorized Hyundai dealer.
- Do not tamper with or disconnect SRS wiring, or other components of the SRS system. Doing so could result in injury, due to accidental inflation of the airbags or by rendering the SRS inoperative.
- If components of the airbag system must be discarded, or if the vehicle must be scrapped, certain safety precautions must be observed. Your Hyundai dealer knows these precautions and can give you the necessary information. Failure to follow these precautions and procedures could increase the risk of personal injury.
- If you sell your vehicle, make certain that this manual is transferred to the new owner.
- If your car was flooded and has soaked carpeting or water on flooring, you shouldn't try to start the engine; have the car towed to an authorized Hyundai dealer.

B240D01NF-AAT

**Additional Safety Precautions**

- **Never let passengers ride in the cargo area (trunk) or on top of a folded-down back seat.** All occupants should sit upright, fully back in their seats with their seat belts on and their feet on the floor.
- **Passengers should not move out of or change seats while the vehicle is moving.** A passenger who is not wearing a seat belt during a crash or emergency stop can be thrown against the inside of the vehicle, against other occupants, or out of the vehicle.
- **Each seat belt is designed to restrain one occupant.** If more than one person uses the same seat belt, they could be seriously injured or killed in a collision.
- **Do not use any accessories on seat belts.** Devices claiming to improve occupant comfort or reposition the seat belt can reduce the protection provided by the seat belt and increase the chance of serious injury in a crash.
- **Passengers should not place hard or sharp objects between themselves and the airbags.** Carrying hard or sharp objects on your lap or in your mouth can result in injuries if an airbag inflates.
- **Keep occupants away from the airbag covers.** All occupants should sit upright, fully back in their seats with their seat belts on and their feet on the floor. If occupants are too close to the airbag covers, they could be injured if the airbags inflate.
- **Do not attach or place objects on or near the airbag covers.** Any object attached to or placed on the front or side impact airbag covers could interfere with the proper operation of the airbags.
- **Do not modify the front seats.** Modification of the front seats could interfere with the operation of the supplemental restraint system sensing components or side impact airbags.
- **Do not place items under the front seats.** Placing items under the front seats could interfere with the operation of the supplemental restraint system sensing components and wiring harnesses.

- **Never hold an infant or child on your lap.**  
The infant or child could be seriously injured or killed in the event of a crash. All infants and children should be properly restrained in appropriate child safety seats or seat belts in the rear seat.



**WARNING:**

- **Sitting improperly or out of position can result in serious injury or death in a crash.**
- **Always sit upright with the seatback in an upright position, centered on the seat cushion with your seat belt on, legs comfortably extended and your feet on the floor.**

### **Adding Equipment to or Modifying Your Airbag-Equipped Vehicle.**

If you modify your vehicle by changing your vehicle's frame, bumper system, front end or side sheet metal or ride height, this may affect the operation of your vehicle's airbag system.

INSTRUMENT CLUSTER AND INDICATOR LIGHTS

B260A01NF-AAT

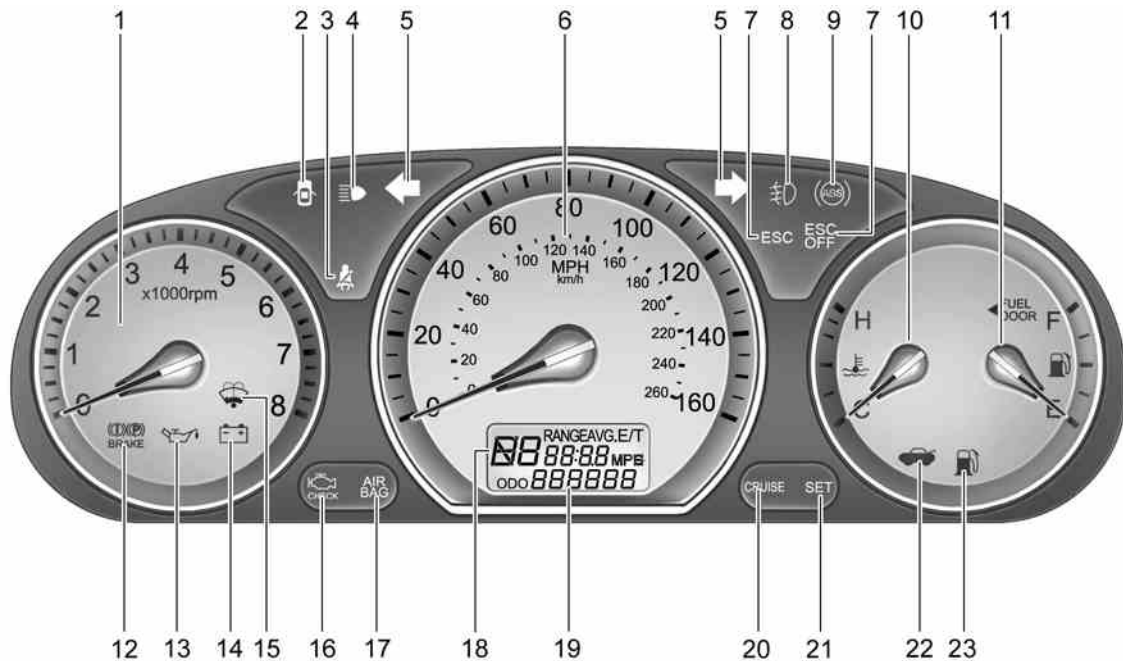

1. Tachometer
2. Door Ajar Warning Light
3. Seat Belt Warning Light (Driver's side)
4. High Beam Indicator Light
5. Turn Signal Indicator Lights
6. Speedometer
7. Electronic Stability Control (ESC) Indicator Lights (If Installed)
8. Front Fog Light Indicator Light
9. ABS Service Reminder Indicator (SRI) (If Installed)
10. Coolant Temperature Gauge
11. Fuel Gauge
12. Parking Brake/Low Brake Fluid Level Warning Light
13. Low Oil Pressure Warning Light
14. Charging System Warning Light
15. Low Windshield Washer Fluid Level Warning Light
16. Check Engine - Malfunction Indicator Light (MIL)
17. SRS (Airbag) Warning Light
18. Automatic Transaxle Position Indicator Light (If Installed)
19. Odometer/ Trip Odometer/ Trip Computer (If Installed)
20. CRUISE Indicator Light
21. Cruise SET Indicator Light
22. Trunk Lid Open Warning Light
23. Low Fuel Warning Light



## WARNING AND INDICATOR LIGHTS

B260B01JM-AAT

**SRS (Airbag) Warning Light**

The SRS warning light comes on for about 6 seconds after the key is turned to the "ON" position or after the engine is started, after which it will go out.

This light also comes on when the SRS is not working properly. If the AIRBAG warning light does not come on, or continuously remains on after operating for about 6 seconds when you turned the ignition key to the "ON" position or started the engine, or if it comes on while driving, have the SRS inspected by an authorized Hyundai dealer.

B260D01A-AAT

**Turn Signal Indicator Lights**

The blinking green arrows on the instrument panel show the direction indicated by the turn signals. If the arrow comes on but does not blink, blinks more rapidly than normal, or does not illuminate at all, a malfunction in the turn signal system is indicated. Your dealer should be consulted for repairs.

B260E01NF-AAT

**Seat Belt Reminder Light and Chime (Driver's side)**

The driver's seat belt reminder light blinks and the warning chime sounds for 6 seconds when the ignition key is turned from the "OFF" position to the "ON" or "START" position to remind the driver to fasten the driver's seat belt.

B260F01A-AAT

**High Beam Indicator Light**

The high beam indicator light comes on whenever the headlights are switched to the high beam or flash position.

B260A01Y-GAT

**Front Fog Light Indicator Light**

This fog indicator light comes on when the ignition key is turned to the "ON" position and the front fog light switch is on.

B260G01A-AAT

**Low Oil Pressure Warning Light****CAUTION:**

If the low oil pressure warning light stays on while the engine is running, serious engine damage may result. The oil pressure warning light comes on whenever there is insufficient oil pressure. In normal operation, it should come on when the ignition switch is turned on, then go out when the engine is started. If the oil pressure warning light stays on while the engine is running, there is a serious malfunction.

If this happens, stop the car as soon as it is safe to do so, turn off the engine and check the oil level. If the oil level is low, fill the engine oil to the proper level and start the engine again. If the light stays on with the engine running, turn the engine off immediately. In any instance where the oil light stays on when the engine is running, the engine should be checked by a Hyundai dealer before the car is driven again.

B260H02A-AAT



### Parking Brake/Low Brake Fluid Level Warning Light



#### WARNING:

If you suspect brake trouble, have your brakes checked by a Hyundai dealer as soon as possible. Driving your car with a problem in either the brake electrical system or brake hydraulic system is dangerous, and could result in a serious injury or death.

### Warning Light Operation

The parking brake/brake fluid level warning light should come on when the parking brake is applied and the ignition switch is turned to "ON" or "START". After the engine is started, the light should go out when the parking brake is released.

If the parking brake is not applied, the warning light should come on when the ignition switch is turned to "ON" or "START", then go out when the engine starts. If the light comes on at any other time, you should slow the vehicle and bring it to a complete stop in a safe location off the roadway.

The brake fluid level warning light indicates that the brake fluid level in the brake master cylinder is low and hydraulic brake fluid conforming to DOT 3 or DOT 4 specifications should be added. After adding fluid, if no other trouble is found, the car should be immediately and carefully driven to a Hyundai dealer for inspection. If further trouble is experienced, the vehicle should not be driven at all but taken to a dealer by a professional towing service or some other safe method.

Your Hyundai is equipped with dual-diagonal braking systems. This means you still have braking on two wheels even if one of the dual systems should fail. With only one of the dual systems working, more than normal pedal travel and greater pedal pressure are required to stop the car. Also, the car will not stop in as short a distance with only half of the brake system working. If the brakes fail while you are driving, shift to a lower gear for additional engine braking and stop the car as soon as it is safe to do so.

B260J02A-AAT



### Charging System Warning Light

The charging system warning light should come on when the ignition is turned on, then go out when the engine is running. If the light stays on while the engine is running, there is a malfunction in the electrical charging system. If the light comes on while you are driving, stop, turn off the engine and check under the hood. First, make certain the generator drive belt is in place. If it is, check the tension of the belt. Do this as shown on page 6-19 by pushing down on the center of the belt. Have the system checked by your Hyundai dealer as soon as possible.

B260K01S-AAT



### Trunk Lid Open Warning Light

This light remains on unless the trunk lid is completely closed and latched.

B260L02HP-GAT



### Door Ajar Warning Light and Chime

The door ajar warning light warns you that a door is not completely closed and the chime warns you that the key is in the ignition switch.

#### NOTE :

**The warning chime only sounds whenever the key is in the ignition switch and the driver's side front door is open simultaneously. The chime sounds until the key is removed from the ignition switch or the driver's side front door is closed.**

B260M01A-AAT



### Low Fuel Level Warning Light

The low fuel level warning light comes on when the fuel tank is approaching empty. When it comes on, you should add fuel as soon as possible. Driving with the fuel level warning light on or with the fuel level below "E" can cause the engine to misfire and damage the catalytic converter.

B260N02A-AAT



### Check Engine - Malfunction Indicator Light (MIL)

This light illuminates when there is a malfunction of an exhaust gas related component, and the system is not functioning properly so that the exhaust gas regulation values are not satisfied. This light will also illuminate when the ignition key is turned to the "ON" position, and will go out in a few seconds after the engine is started. If it illuminates while driving, or does not illuminate when the ignition key is turned to the "ON" position, take your car to your nearest authorized Hyundai dealer and have the system checked.

B260P02Y-GAT



### ABS Service Reminder Indicator (SRI) (If Installed)

When the key is turned to the "ON" position, the Anti-Lock Brake System indicator will come on and then go off in a few seconds. If the ABS SRI remains on, comes on while driving, or does not come on when the key is turned to the "ON" position, this indicates that there may be a problem with the ABS. If this occurs, have your vehicle checked by your Hyundai dealer as soon as possible. The normal braking system will still be operational, but without the assistance of the anti-lock brake system.



#### WARNING:

**If both the ABS SRI and Parking Brake/ Brake fluid level warning lights remain "ON" or come on while driving, there may be a problem with E.B.D. (Electronic Brake Force Distribution). If this occurs, avoid sudden stops and have your vehicle checked by your Hyundai dealer as soon as possible.**

B265C01NF-AAT



### Electronic Stability Control (ESC) Indicator Lights (If Installed)

The electronic stability control indicators change operation according to the ignition switch position and whether the system is in operation or not.

They will illuminate when the ignition key is turned to the "ON" position, but should go out after three seconds. If the ESC or ESC-OFF indicator stays on, take your car to your authorized Hyundai dealer and have the system checked. See section 2 for more information about the ESC.

## INSTRUMENT CLUSTER

B260Q01NF-GAT

**CRUISE Indicator Light**

The cruise indicator light in the instrument cluster is illuminated when the cruise control ON/OFF button on the steering wheel is pushed. The indicator light turns off when the cruise control ON/OFF button is pushed again. Information about the use of cruise control begins on page 1-93.

B260R01NF-GAT

**Cruise SET Indicator Light**

The Cruise SET indicator light in the instrument cluster is illuminated when the cruise control "COAST/SET" or "RES/ACCEL" switch is pushed. The Cruise SET indicator light does not illuminate when the cruise control "CANCEL" switch is pushed or the system is disengaged. To disengage the cruise control system, refer to "To cancel the cruise speed" on page 1-94.

B260S01NF-GAT

**Low Windshield Washer Fluid Level Warning Light**

The low windshield washer fluid warning light comes on when the washer fluid reservoir is approaching empty. When it comes on, add washer fluid at your earliest opportunity.

B270A01O-AAT

**BRAKE PAD WEAR WARNING SOUND**

The front and rear disc brake pads have wear indicators that should make a high-pitched squealing or scraping noise when new pads are needed. The sound may come and go or be heard all the time when the vehicle is moving. It may also be heard when the brake pedal is pushed down firmly. Excessive rotor damage will result if the worn pads are not replaced. See your Hyundai dealer immediately.

B280A01NF-AAT

**FUEL GAUGE**

The needle on the gauge indicates the approximate fuel level in the fuel tank. The fuel capacity is given in section 9.

**NOTE:**

The "  " symbol means, the fuel filler lid is located on the left side of the vehicle.

B290A03A-AAT

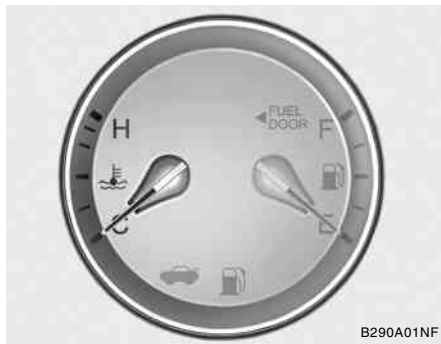
**ENGINE COOLANT TEMPERATURE GAUGE**

The normal range is approximately in the middle between "H" and "C". If it moves across the dial to "H" (HOT), pull over and stop as soon as possible and turn off the engine. Then open the hood and, after the engine has cooled, check the coolant level (See "If the engine overheats" on the page 3-4.) and the water pump drive belt. If you suspect cooling system trouble, have your cooling system checked by a Hyundai dealer as soon as possible.

B330A03A-AAT

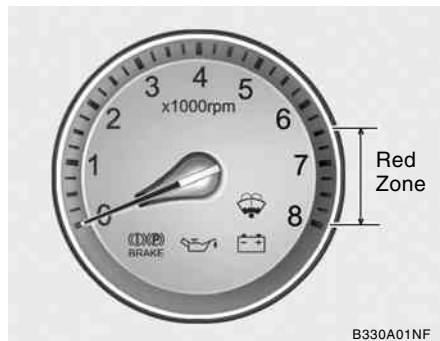
**TACHOMETER**

The tachometer registers the speed of your engine in revolutions per minute (rpm).

**WARNING:**

Never remove the radiator cap when the engine is hot. The engine coolant is under pressure and could erupt and cause severe burns. Wait until the engine is cool before adding coolant to the reservoir.

**CAUTION:**

The engine should not be raced to such a speed that the needle enters the red zone on the tachometer face. This can cause severe engine damage and may void your warranty coverage.

B300A01A-AAT

**SPEEDOMETER**

2.4L



B300A02NF-A

3.3L



B300A01NF-A

Your Hyundai's speedometer is calibrated in miles per hour or kilometers per hour.

B310B01NF-AAT

**ODOMETER/TRIP ODOMETER**

With Automatic Transaxle



With Manual Transaxle



B310B01NF-A

**1. Odometer**

The odometer records the total distance traveled in miles. You will also find the odometer useful to determine when periodic maintenance should be performed.

**NOTE:**

**Federal law forbids alteration of the odometer of any vehicle with the intent to change the mileage registered on the odometer. The alteration may void your warranty coverage.**

**2. Trip Odometer  
(Without Trip Computer)**

B400B01NF-A

Pushing in the TRIP switch behind the left side of the steering wheel when the ignition switch is turned "ON" will display two trip odometers in miles.

With Automatic Transaxle



B310B03NF-A

With Manual Transaxle



B310B04NF-A

To shift from TRIP A to TRIP B, press the TRIP switch.

**TRIP A:** First distance you have traveled from your origination point to a first destination.

**TRIP B:** Second distance from the first destination to the final destination.



B310B02NF-A

When the RESET switch is pressed for 1 second, the trip odometer will reset to 0.

## TRIP COMPUTER

B400B01NF-AAT

**(With Automatic Transaxle)(If Installed)**

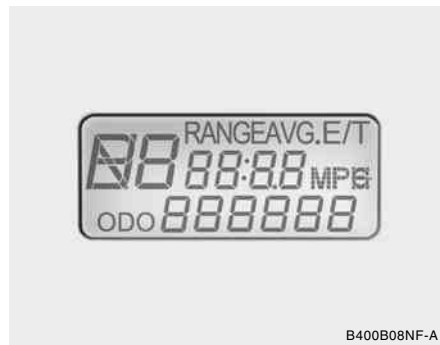

B400B08NF-A

The trip computer is a microcomputer-controlled driver information gauge that displays information related to driving, such as estimated tripmeter, drive time, average speed, average fuel consumption and distance to empty on the LCD.

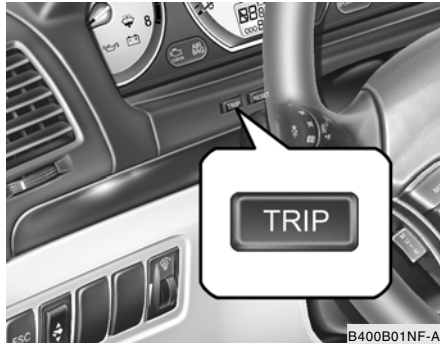
**TRIP SWITCH**

Pushing in the TRIP switch when the ignition switch is in "ON" position changes the display as follows;

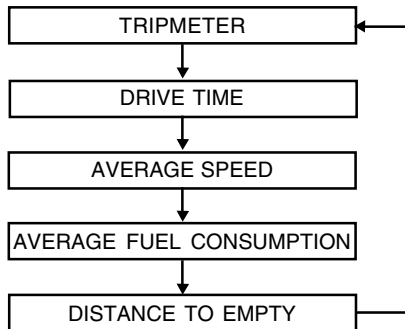
**RESET SWITCH**

Push in the RESET switch for more than 1 second to initialize the displayed information such as tripmeter, average speed, average fuel consumption and drive time.

**1. Tripmeter (Miles)**

- o This mode indicates the total distance travelled since the last tripmeter reset. Total distance is also reset to zero if the battery is disconnected.
- o Pressing the RESET switch for more than 1 second, when the tripmeter is being displayed, clears the tripmeter to zero.
- o The meter's working range is from 0 to 999.9 miles.



## 2. Drive Time



- o This mode indicates the total time from the starting of the engine to the ignition key "OFF" after resetting. When the RESET switch is pushed, it will be initialized to '0:00'.
- o The drive time will be initialized to '0:00' after being displayed to '99:59'.

## 3. Average Speed (MPH)



- o This mode indicates the average speed from the starting of the engine to the ignition key "OFF".
- o Average speed is reset to zero if the battery is disconnected.
- o To reset the average speed to zero (---), press the RESET switch for more than 1 second.
- o When you drive 0.5 mile and less after resetting, the average speed will be displayed to '---'.

## 4. Average Fuel Consumption (MPG)

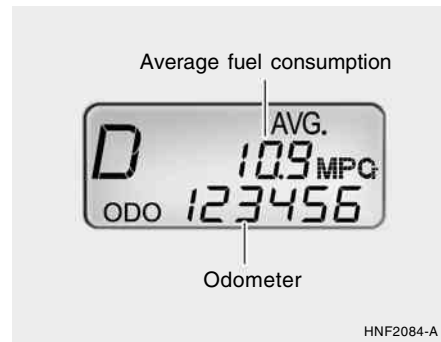

- o This mode calculates the average fuel consumption from the total fuel used and the distance since the last average consumption reset.
- o The total fuel used is calculated from the fuel consumption input.
- o Average fuel consumption is reset to zero if the battery is disconnected.
- o To reset the average fuel consumption to zero (--), press the RESET switch for more than 1 second.
- o When you drive 0.5 mile and less after resetting, the average fuel consumption will be displayed to '--'.

## 5. Distance to Empty (Miles)



- o This mode indicates the estimated distance to empty from the current fuel level in the fuel tank.
- o The trip computer may not register additional fuel if less than 1.36 gallons (6 liters) of fuel are added to the vehicle.



- o When the distance to empty is less than 30 miles (50 km), the distance to empty digits (---) will blink until more fuel is added.

### NOTE:

- o **The distance to empty can differ from the actual tripmeter according to driving conditions.**
- o **The distance to empty can vary according to the driving conditions, driving pattern or vehicle speed.**

B340A01A-AAT

## COMBINATION TURN SIGNAL, HEADLIGHT AND HIGH-BEAM SWITCH

### Turn Signal Operation

Pulling down on the lever causes the turn signals on the left side of the car to blink. Pushing upwards on the lever causes the turn signals on the right side of the car to blink. As the turn is completed, the lever will automatically return to the center position and turn off the turn signals at the same time. If either turn signal indicator light blinks more rapidly than usual, goes on but does not blink, or does not go on at all, there is a malfunction in the system. Check for a burned-out fuse or bulb or see your Hyundai dealer.

B340B01A-AAT

### Lane Change Signal



To indicate a lane change, move the lever up or down to a point where it begins flashing. The lever will automatically return to the center position when released.

B340C03A-AAT

### Headlight Switch



To operate the headlights, turn the barrel on the end of the multi-function switch. The first position turns on the parking lights, sidelights, tail lights and instrument panel lights. The second position turns on the headlights.

#### NOTE:

The ignition must be in the "ON" position to turn on the headlights.

#### Parking Light Auto Off

If you do not turn the parking lights "OFF" after driving, the parking lights will automatically shut "OFF" when the driver's door is opened. To turn them "ON" again, you must simply turn the ignition key to the "ON" position.

B340D01A-AAT

### High-beam Switch



To turn on the headlight high beams, push the lever forward (away from you). The High Beam Indicator Light will come on at the same time. For low beams, pull the lever back toward you.

B340E01A-AAT

**Headlight Flasher**

B340E01NF

To flash the headlights, pull the switch lever toward you, then release it. The headlights can be flashed even though the headlight switch is in the "OFF" position.

B340G01LZ-AAT

**Auto Light (If Installed)**

HNF2094

To operate the automatic light feature, turn the barrel on the end of the multi-function switch. If you set the multi-function switch to "AUTO", the tail lights and headlights will be turned automatically on or off according to external illumination conditions.

**NOTE:**

Turn the lights manually in foggy, cloudy and rainy conditions.



B340G02NF-A

**NOTE:**

- o Never place anything over the sensor located on the instrument panel to ensure better auto light system control.
- o Don't clean the sensor using a window cleaner.
- o If your vehicle has window tint or other types of coating on the windshield, the AUTO light system may not work properly.

## FRONT FOG LIGHT SWITCH

B360B01L-AAT



B360B02NF

To turn on the front fog lights, place the switch in the "ON" position. They will light when the headlight switch is in the second position.

### NOTE:

If you turn on the headlight high beams, the front fog lights will be turned off.

## WINDSHIELD WIPER AND WASHER SWITCH

B350A01A-AAT

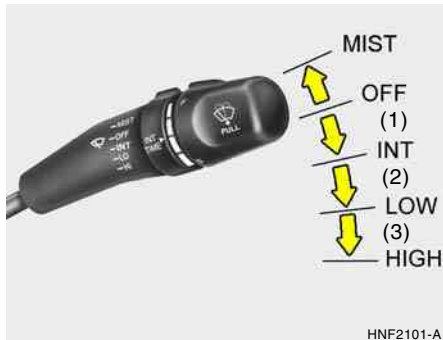

HNF2101-A

The windshield wiper switch has three positions:

1. Intermittent wiper operation
2. Low-speed operation
3. High-speed operation

### NOTE:

To prevent damage to the wiper system, do not attempt to wipe away heavy accumulations of snow or ice. Accumulated snow and ice should be removed manually. If there is only a light layer of snow or ice, operate the heater in the defrost mode to melt the snow or ice before using the wiper.

B350B01O-GAT

## Windshield Washer Operation



HNF2103-A

To use the windshield washer, pull the wiper/washer lever toward the steering wheel. When the washer lever is operated, the wipers automatically make two passes across the windshield. The washer continues to operate until the lever is released.

### NOTE:

- o Do not operate the washer more than 15 seconds at a time or when the fluid reservoir is empty.
- o In icy or freezing weather, be sure the wiper blades are not frozen to the glass prior to operating the wipers.
- o In areas where water freezes in winter, use windshield washer antifreeze.

## Mist Wiper Operation

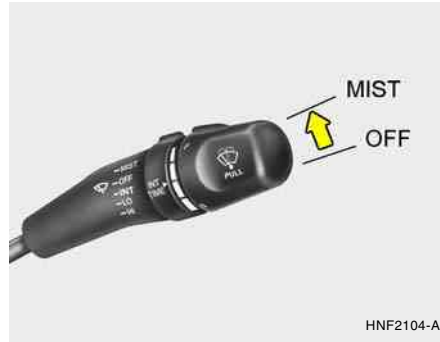

If a single wipe is desired to clear mist, push the windshield wiper and washer control lever upwards.

B350C01NF-AAT

## Adjustable Intermittent Wiper Operation



To use the intermittent wiper feature, place the wiper switch in the "INT" position. With the switch in this position, the interval between wipes can be varied from approximately 1 to 18 seconds by turning the interval adjuster barrel.

B370A01A-AAT



The hazard warning system should be used whenever you find it necessary to stop the car in a hazardous location. When you must make such an emergency stop, always pull off the road as far as possible.

The hazard warning lights are turned on by pushing in the hazard switch. This causes all turn signal lights to blink. The hazard warning lights will operate even though the key is not in the ignition.

To turn the hazard warning lights off, push the switch a second time.

## REAR WINDOW DEFROSTER SWITCH

B380A01HP-AAT

With Manual A/C



With Automatic A/C



HNF2113-A

The rear window defroster switch also activates the outside rearview mirror heaters. The rear window defroster and heated outside rearview mirrors are turned on by pushing in the switch. To turn the defroster off, push the switch a second time. The rear window defroster automatically turns itself off after about 20 minutes. To restart the defroster cycle, push in the switch again after it has turned itself off.



### CAUTION:

Do not clean the inner side of the rear window glass with an abrasive type of glass cleaner or use a scraper to remove foreign deposits from the inner surface of the glass as this may cause damage to the defroster elements.

### NOTE:

The ignition must be in the "ON" position for the rear window defroster to operate.

## DIGITAL CLOCK

B400A01NF-GAT



B400A01NF-A

There are three control buttons for the digital clock. Their functions are:

- H** - Push "H" to advance the hour indicated.
- M** - Push "M" to advance the minute indicated.
- R** - Push "R" to reset minutes to ":00" to facilitate resetting the clock to the correct time. When this is done:  
 Pressing "R" between 11 : 01 and 11 : 29 changes the readout to 11 : 00.  
 Pressing "R" between 11 : 30 and 11 : 59 changes the readout to 12 : 00.  
 Push the "R" button for 5 seconds to display a 12 or 24-hour clock.

## INSTRUMENT PANEL LIGHT CONTROL (RHEOSTAT)

B410A01A-AAT



B410A01NF-A

The instrument panel lights can be made brighter or dimmer by turning the instrument panel light control knob.

## CIGARETTE LIGHTER

B420A02A-AAT

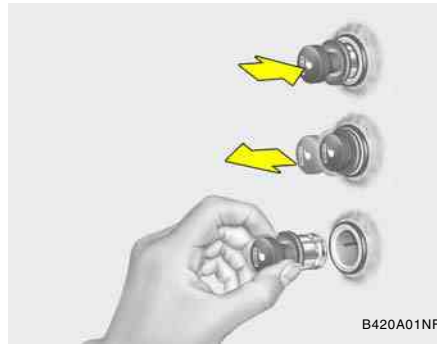

B420A01NF

For the cigarette lighter to work, the key must be in the "ACC" position or the "ON" position. To use the cigarette lighter, push it all the way into its socket. When the element has heated, the lighter will pop out to the "ready" position. Do not hold the cigarette lighter pressed in. This can damage the heating element and create a fire hazard.

If it is necessary to replace the cigarette lighter, use only a genuine Hyundai replacement or its approved equivalent.



### CAUTION:

Do not use electric accessories or equipment other than the Hyundai genuine parts in the socket.

## POWER OUTLETS

B500D01NF-AAT



HNF2182

The power outlets are located on the center fascia panel and in the trunk. These supply 12V electric power to operate electric accessories or equipment only when the key is in the "ON" or "ACC" position.



**CAUTION:**

- o Use the power outlets only when the engine is running and remove the plug from the power outlet after using the electric device. Using the power outlets when the engine stops or keeping the electric device plugged in for many hours may cause the battery to discharge.
- o Do not use the power outlet to connect electric accessories or equipment that are not designed to operate on 12 volts.
- o Some electronic devices can cause electronic interference when plugged into the power outlet. These devices may cause excessive audio noise and malfunctions in other electronic systems or devices in your vehicle.

**ASHTRAY**

B430A02NF-GAT

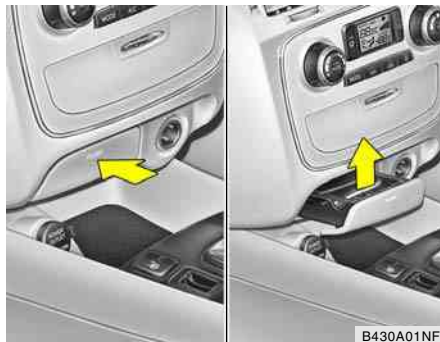

B430A01NF

The front ashtray may be opened by pushing and releasing the ashtray lid. To clean ashtray, the plastic receptacle should be removed by lifting the plastic ash receptacle upward and pulling it out. The ashtray light will only illuminate when the external lights are on.

**DRINK HOLDER**

B450A01NF-GAT

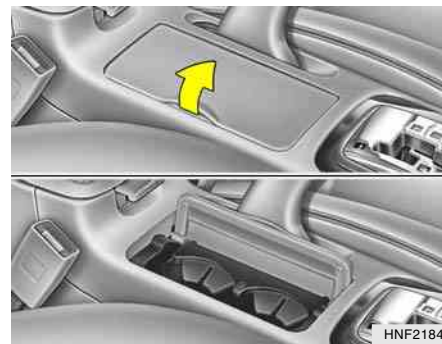
**Front Drink Holder**

HNF2184

The drink holder for holding cups or cans is located on the main console. The drink holder can be used by lifting its cover.

## SHOPPING BAG HOLDER

B450B01NF-GAT

## Rear Drink Holder

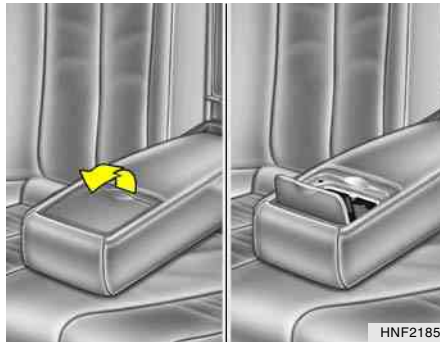

The rear drink holder for holding cups or cans is located in the center of the rear seat armrest.

**CAUTION:**

Place the drink holder in its closed position while not in use.

**WARNING:**

- o Use caution when using the drink holders. A spilled beverage that is very hot can injure you or your passengers. Spilled liquids can damage interior trim and electrical components.
- o Do not place objects other than cups or cans in the drink holder. These objects can be thrown out in the event of a sudden stop or an accident, possibly injuring the passengers in the vehicle.

B540A01NF-AAT

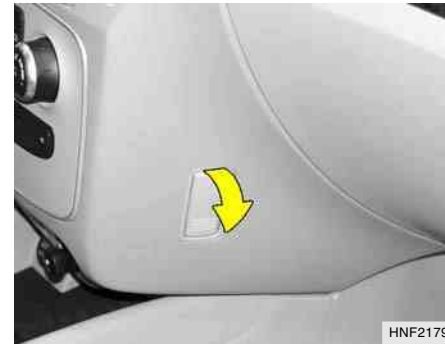

Shopping bag holder is located on the left side of the glove box.

**CAUTION:**

Do not hang a bag beyond 7lbs (3 kg). It may cause damage to the shopping bag holder.

## SEATBACK POCKET

B540B01E-GAT



The seatback pockets for holding papers are located on the backside of the front seats.

## SUNROOF

B460A02Y-AAT

### (If Installed) Sun Shade

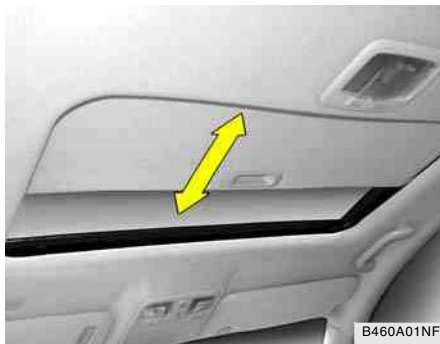

Your HYUNDAI is equipped with a sliding sunshade which you can manually adjust to let in light with the sunroof closed, or to block sunlight.



### WARNING:

Never adjust the sunshade while driving. This could result in loss of control and an accident that may cause death, serious injury, or property damage.

B460B01NF-GAT

### Opening the Sunroof System



If your vehicle is equipped with this feature, you can slide or tilt your sunroof with the sunroof control buttons located on the overhead console.

The sunroof can only be opened, closed, or tilted when the ignition switch is in the "ON" position.

## Sliding the sunroof

### Auto slide open

To use the auto slide feature, momentarily (more than 1 second) press the SLIDE OPEN (①) button on the overhead console. The sunroof will slide all the way open. To stop the sunroof sliding at any point, press any sunroof control button.

### Manual slide open

Press the SLIDE OPEN (①) button on the overhead console for less than 0.5 second.

## Close

### Auto slide close

To close the sunroof, press the TILT UP (②) button on the overhead console for more than 1 second.

The sunroof will slide all the way close. To stop at the desired point, press any sunroof control button.

### Manual slide close

Press the TILT UP (②) button on the overhead console for less than 0.5 second.

B460C01NF-GAT

## Tilting the Sunroof System



### Auto tilt open

To use the auto tilt feature, momentarily (more than 1 second) press the TILT UP (①) button on the overhead console. The sunroof will tilt all the way open. To stop the sunroof tilting at any point, press any sunroof control button.

### Manual tilt open

Press the TILT UP (①) button on the overhead console for less than 0.5 second.

## Close

To close the sunroof, press the SLIDE OPEN (②) button on the overhead console and hold it until the sunroof is closed.

## NOTE:

**After washing the car or after there is rain, be sure to wipe off any water that is on the sunroof before operating it.**

**!** **WARNING:**

- o Do not close a sunroof if anyone's hands, arms or body are between the sliding glass and the sunroof sash, as this could result in injury.
- o Do not place your head or arms out of the sunroof opening at any time.

**CAUTION:**

- o Do not open the sunroof in severely cold temperatures or when it is covered with ice or snow.
- o Periodically remove any dirt that may have accumulated on the guide rails.
- o Do not press any sunroof control button longer than necessary. Damage to the motor or system components could occur.

B460D01NF-GAT

**Manual Operation of Sunroof**

If the sunroof does not operate electrically:



1. Open the spectacle case.
2. Remove the two mounting screws of the front overhead console with a phillips screwdriver.



3. Insert the hexagonal head wrench provided with the vehicle into the socket. This wrench can be found in the vehicle's glove box.
4. Turn the wrench clockwise to open or counterclockwise to close the sunroof.

## INTERIOR LIGHT

B460E01NF-AAT

### Resetting the sunroof

Whenever the vehicle battery is disconnected or discharged, or you use the emergency handle to operate the sunroof, you have to reset your sunroof system as follows:

1. Turn the ignition key to the "ON" position.
2. According to the position of the sunroof, do as follows.
  - 1) In case that the sunroof has closed completely or been tilted : Press the TILT UP button for 1 second.
  - 2) In case that the sunroof has been opened: Press and hold the TILT UP button for more than 5 seconds until the sunroof has closed completely. Then press the TILT UP button for 1 second.
3. Then, release it.
4. Press and hold the TILT UP button once again until the sunroof has returned to the original TILT UP position after it raises a little higher than the maximum TILT UP position. When this is complete, the sunroof system is reset.



### CAUTION:

If the sunroof is not reset, it may not operate properly.

B480B01Y-AAT

### Map Light

Without sunroof



With sunroof



Push in the map light switch to turn the light on or off. This light produces a spot beam for convenient use as a map light at night or as a personal light for the driver and the passenger.

B490A02NF-GAT

### Interior Light



The interior courtesy light has two buttons. The two buttons are:

#### o DOOR

In the "DOOR" position, the interior courtesy light comes on when any door is opened regardless of the ignition key position. The light goes out gradually 30 seconds after the door is closed.

#### o ON

In the "ON" position, the light stays on at all times.



**CAUTION:**

Do not leave this button pressed for an extended period of time when the vehicle is not running.

**SPECTACLE CASE**

B491A030-GAT



The spectacle case is located on the front overhead console.  
Push the end of the cover to open the spectacle case.



**WARNING:**

Do not keep objects except spectacles inside the spectacle case. Such objects can be thrown from the case in the event of a sudden stop or an accident, possibly injuring the passengers in the vehicle.

**STORAGE BOX**

B500A01Y-AAT

**GLOVE BOX**

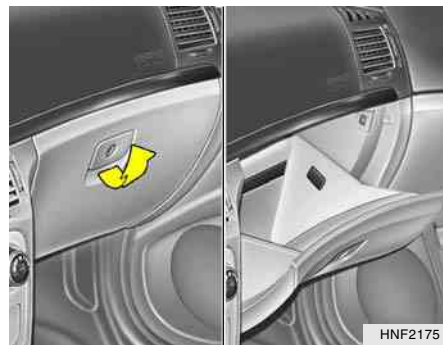

**WARNING:**

To avoid the possibility of injury in case of an accident or a sudden stop, the glove box door should be kept closed when the car is in motion.

- o To open the glove box, pull on the glove box release lever.
- o The glove box door can be locked (and unlocked) with the key.

B500B01NF-GAT

**Illuminated Glove Box**

Opening the glove box will automatically turn on the light when the multi-function switch is turned to the first position.

B500B01HP-DAT

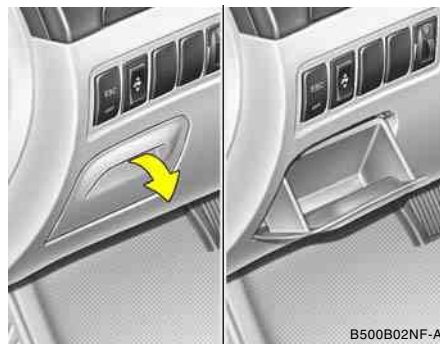
**MULTI BOX**

The multi box may be opened by pulling it out by its grip. It is used for storing small articles.

B500A01NF-GAT

**ACCESSORY BOX**

The accessory box may be opened by pushing the knob downward. It is used for storing small articles.



## CENTER CONSOLE COMPARTMENT

B505A01NF-GAT

### Center Console Box

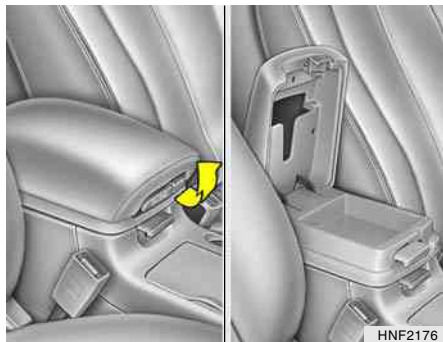

The center console box is used for storing cassette tapes or small articles.

To use the center console box, pull up the handle and lift the lid as shown.

**!** **WARNING:**  
To avoid the possibility of injury in case of an accident or a sudden stop, the center console box lid should be kept closed when the car is in motion.

B505B01NF-GAT

### Center Console Armrest (If Installed)

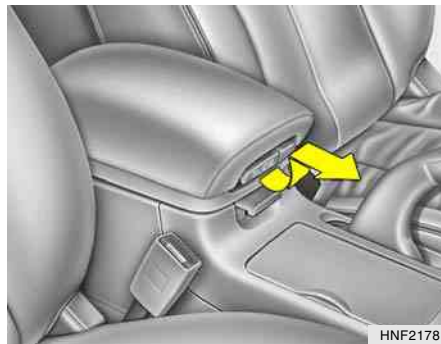

The center console box can be used as armrest. To use the console armrest, pull out the console box lid by pulling up the handle as shown.

#### NOTE:

When not in use, always be sure it is locked in position properly.

## OUTSIDE REARVIEW MIRROR

B510B01Y-AAT

### Electric Type



B510B01NF

The outside rearview mirrors can be adjusted to your preferred rear vision, both directly behind the vehicle, and to the rear of the left and right sides.

The remote control outside rearview mirror switch controls the adjustments for both right and left outside mirrors.

### To adjust the position of either mirror:

1. Move the selecting switch to the right or left to activate the adjustable mechanism for the corresponding door mirror.
2. Adjust mirror angle by depressing the appropriate perimeter switch as illustrated.



### WARNING:

Do not place cups or cans in the drink holder when the console box lid is used as an armrest. It may result in spilling the beverage. A spilled beverage that is very hot can injure you or your passengers. Spilled liquids can damage interior trim and electric components.



### CAUTION:

- o Do not operate the switch continuously for an unnecessary length of time.
- o Scraping ice from the mirror face could cause permanent damage. To remove any ice, use a sponge, soft cloth or approved de-icer.



### WARNING:

Be careful when judging the size or distance of any object seen in the passenger side rearview mirror. It is a convex mirror with a curved surface, and any objects seen in this mirror are closer than they appear.

B510D01HP-AAT

**OUTSIDE REARVIEW MIRROR HEATER**

With Manual A/C



With Automatic A/C



HNF2113-A

The outside rearview mirror heater is actuated in connection with the rear window defroster. To heat the outside rearview mirror glass, push in the switch for the rear window defroster. The rearview mirror glass will be heated for defrosting or defogging and will give you improved rear vision in inclement weather conditions. Push the switch again to turn the heater off. The outside rearview mirror heater automatically turns itself off after 20 minutes.

**DAY/NIGHT INSIDE REARVIEW MIRROR**

B520A01A-AAT

**Manual Type**

B520A01NF

Your Hyundai is equipped with a day/night inside rearview mirror. The "night" position is selected by flipping the tab at the bottom of the mirror toward you. In the "night" position, the glare of headlights of cars behind you is reduced.

## HOMELINK MIRROR

B520C01NF-AAT

### Automatic-Dimming Mirror with Z-Nav™ Electronic Compass Display and HomeLink® (If Installed)

Your vehicle comes with a Gentex Automatic-Dimming Mirror with a Z-Nav™ Electronic Compass Display and an Integrated HomeLink® Wireless Control System. During nighttime driving, this safety feature will automatically detect and eliminate dangerous rearview mirror glare while the compass indicates the direction the vehicle is pointed. The HomeLink® Universal Transceiver allows you to activate your garage door(s), estate gate, home lighting, etc.



B520C01NF

- |                         |                           |
|-------------------------|---------------------------|
| 1. Channel 1 Button     | 5. Rear Light Sensor      |
| 2. Channel 2 Button     | 6. Dimming On/Off Button  |
| 3. Status Indicator LED | 7. Compass Control Button |
| 4. Channel 3 Button     | 8. Display                |

## Automatic-Dimming Night Vision Safety™ (NVS®) Mirror

The NVS® Mirror in your vehicle is the most advanced way to eliminate dangerous and annoying glare in the rearview mirror during any driving situation. For more information regarding NVS® mirrors and other applications, please refer to the Gentex website: [www.gentex.com](http://www.gentex.com).





### CAUTION:

The NVS® Mirror automatically reduces glare during driving conditions based upon light levels monitored in front of the vehicle and from the rear of the vehicle. These light sensors are visible through openings in the front and rear of the mirror case. Any object that would obstruct either light sensor will degrade the automatic dimming control feature.

## Automatic-Dimming Function

To protect your vision during nighttime driving, your mirror will automatically dim upon detecting glare from the vehicles traveling behind you. The auto-dimming function can be controlled by the Dimming ON/OFF Button:

1. Pressing the  button turns the auto-dimming function OFF which is indicated by the green Status Indicator LED turning off.
2. Pressing the  button again turns the auto-dimming function ON which is indicated by the green Status Indicator LED turning on.

### NOTE:



The mirror defaults to the "ON" position each time the vehicle is started.

## Z-Nav™ Compass Display

The NVS™ Mirror in your vehicle is also equipped with a Z-Nav™ Compass that shows the vehicle Compass heading in the Display Window using the 8 basic cardinal headings (N, NE, E, SE, etc.).

### Compass Function

The Compass can be turned ON and OFF and will remember the last state when the ignition is cycled. To turn the display feature ON/OFF:



1. Press and release the  button to turn the display feature OFF.
2. Press and release the  button again to turn the display back ON.

Additional options can be set with press and hold sequences of the -button and are detailed below.

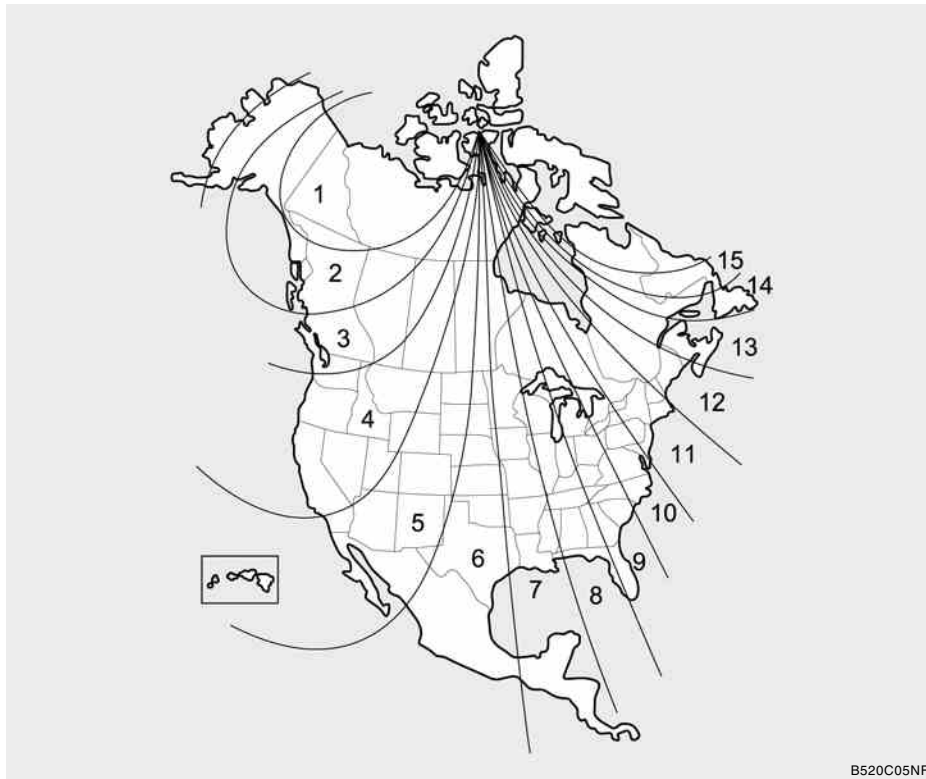
There is a difference between magnetic north and true north. The compass in the mirror can compensate for this difference when it knows the Magnetic Zone in which it is operating. This is set either by the dealer or by the user. The operating Zone Numbers for North America are shown in the figure to the right.



To adjust the Zone setting:

1. Determine the desired Zone Number based upon your current location on the Zone Map.
2. Press and hold the  button for more than 3 but less than 6 seconds, the current Zone Number will appear on the display.
3. Pressing and holding the  button again will cause the numbers to increment (Note: they will repeat ...13, 14, 15, 1, 2, ...). Releasing the button when the desired Zone Number appears on the display will set the new Zone.
4. Within about 5 seconds the compass will start displaying a compass heading again.

There are some conditions that can cause changes to the vehicle magnets. Items such as installing a ski rack or a CB antenna or even some body repair work on the vehicle can cause changes to the vehicle's magnetic field. In these situations, the compass will need to be re-calibrated to quickly correct for these changes. To re-calibrate the compass:

1. Press and hold the  button for more than 6 seconds. When the compass memory is cleared a "C" will appear in the display.
2. To calibrate the compass, drive the vehicle in 2 complete circles at less than 5 MPH (8 Km/h).

## Integrated HomeLink® Wireless Control System

The HomeLink® Wireless Control System provides a convenient way to replace up to three hand-held radio-frequency (RF) transmitters with a single built-in device. This innovative feature will learn the radio frequency codes of most current transmitters to operate devices such as gate operators, garage door openers, entry door locks, security systems, even home lighting. Both standard and rolling code-equipped transmitters can be programmed by following the outlined procedures. Additional HomeLink® information can be found at: [www.homelink.com](http://www.homelink.com) or by calling 1-800-355-3515.



### CAUTION:

**Before programming HomeLink® to a garage door opener or gate operator, make sure that people and objects are out of the way of the device to prevent potential harm or damage. Do not use HomeLink® with any garage door opener that lacks the safety stop and reverse features as required by U.S. federal safety standards (this includes any garage door opener model manufactured before April 1, 1982). A garage door that cannot detect an object - signaling the door to stop and reverse - does not meet current U.S. federal safety standards. Using a garage door opener without these features increases the risk of serious injury or death.**

Retain the original transmitter of the RF device you are programming for use in other vehicles as well as for future HomeLink® programming. It is also suggested that upon the sale of the vehicle, the programmed HomeLink® buttons be erased for security purposes.

## Programming HomeLink®

### NOTE:

- o When programming a garage door opener, it is advised to park the vehicle outside of the garage.
- o It is recommended that a new battery be placed in the hand-held transmitter of the device being programmed to HomeLink® for quicker training and accurate transmission of the radio-frequency signal.
- o Some vehicles may require the ignition switch to be turned to the second (or "accessories") position for programming and/or operation of HomeLink.
- o In the event that there are still programming difficulties or questions after following the programming steps listed below, contact HomeLink® at: [www.homelink.com](http://www.homelink.com) or 1-800-355-3515.

## Standard Programming

To train most devices, follow these instructions:

1. For first-time programming, press and hold the two outside buttons, HomeLink® Channel 1 and Channel 3 Buttons, until the indicator light begins to flash (after 20 seconds). Release both buttons. Do not hold the buttons for longer than 30 seconds.
2. Position the end of your hand-held transmitter 1-3 inches (5-14 cm) away from the HomeLink® buttons while keeping the indicator light in view.
3. Simultaneously press and hold both the HomeLink® and hand-held transmitter button. DO NOT release the buttons until step 4 has been completed.
4. While continuing to hold the buttons the red Indicator Status LED will flash slowly and then rapidly after HomeLink® successfully trains to the frequency signal from the hand-held transmitter. Release both buttons.
5. Press and hold the just-trained HomeLink® button and observe the red Status Indicator LED. If the indicator light stays on constantly, programming is complete and your device should activate when the HomeLink® button is pressed and released.
6. To program the remaining two HomeLink® buttons, follow steps 2 through 5.

## Rolling Code Programming

Rolling code devices which are "code-protected" and manufactured after 1996 may be determined by the following:

- o Reference the device owner's manual for verification.
- o The handheld transmitter appears to program the HomeLink Universal Transceiver but does not activate the device.
- o Press and hold the trained HomeLink button. The device has the rolling code feature if the indicator light flashes rapidly and then turns solid after 2 seconds.

To train rolling code devices, follow these instructions:

1. At the garage door opener receiver (motor-head unit) in the garage, locate the "learn" or "smart" button. This can usually be found where the hanging antenna wire is attached to the motor-head unit. Exact location and color of the button may vary by garage door opener brand. If there is difficulty locating the training button, reference the device owner's manual or please visit our Web site at [www.homelink.com](http://www.homelink.com).
2. Firmly press and release the "learn" or "smart" button (which activates the "training light").

## NOTE:

**There are 30 seconds in which to initiate step3.**

3. Return to the vehicle and firmly press, hold for two seconds and then release the desired HomeLink® button. Repeat the "press/hold/release" sequence a second time to complete the programming. (Some devices may require you to repeat this sequence a third time to complete the programming.)
4. Press and hold the just-trained HomeLink® button and observe the red Status Indicator LED. If the indicator light stays on constantly, programming is complete and your device should activate.
5. To program the remaining two HomeLink® buttons, follow either steps 1 through 4 above for other Rolling Code devices or steps 2 through 5 in Standard Programming for standard devices.

## Gate Operator & Canadian Programming

During programming, your handheld transmitter may automatically stop transmitting. Continue to press the Integrated HomeLink® Wireless Control System button (note steps 2 through 4 in the Standard Programming portion of this document) while you press and re-press ("cycle") your handheld transmitter every two seconds until the frequency signal has been learned. The indicator light will flash slowly and



then rapidly after several seconds upon successful training.

### Operating HomeLink®

To operate, simply press and release the programmed HomeLink® button. Activation will now occur for the trained device (i.e. garage door opener, gate operator, security system, entry door lock, home/office lighting, etc.). For convenience, the hand-held transmitter of the device may also be used at any time.

### Reprogramming a Single HomeLink® Button

To program a new device to a previously trained HomeLink® button, follow these steps:

1. Press and hold the desired HomeLink® button. Do NOT release until step 4 has been completed.
2. When the indicator light begins to flash slowly (after 20 seconds), position the handheld transmitter 1 to 3 inches away from the HomeLink® surface.
3. Press and hold the handheld transmitter button. The HomeLink® indicator light will flash, first slowly and then rapidly.
4. When the indicator light begins to flash rapidly, release both buttons.
5. Press and hold the just-trained HomeLink®

button and observe the red Status Indicator LED. If the indicator light stays on constantly, programming is complete and your new device should activate.

### Erasing HomeLink® Buttons

Individual buttons cannot be erased. However, to erase all three programmed buttons:

1. Press and hold the two outer HomeLink® buttons until the indicator light begins to flash-after 20 seconds.
2. Release both buttons. Do not hold for longer than 30 seconds.

The Integrated HomeLink® Wireless Control System is now in the training (learn) mode and can be programmed at any time following the appropriate steps in the Programming sections above.

### FCC ID: NZLZTVHL3

### IC: 4112A-ZTVHL3

This device complies with Part 15 FCC Rules. Operation is subject to the following two conditions: (1) this device may not cause harmful interference, and (2) this device must accept any interference received, including interference that may cause undesired operation.

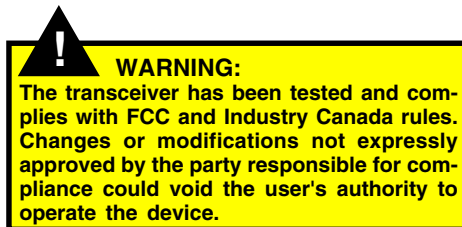

NVS® is a registered trademark and Z-Nav™ is a trademark of the Gentex Corporation, Zeeland, Michigan. HomeLink® is a registered trademark owned by Johnson Controls, Incorporated, Milwaukee, Wisconsin.

## PARKING BRAKE

B530A01A-AAT



B530A01NF

Always engage the parking brake before leaving the vehicle. This also turns on the parking brake indicator light when the key is in the "ON" or "START" position. Before driving away, be sure that the parking brake is fully released and the indicator light is off.

- o To engage the parking brake, pull the lever up as far as possible.
- o To release the parking brake, pull up and press the thumb button. Then, while holding the button in, lower the brake lever.

## TRUNK LID

B540A01S-GAT

### Remote Trunk Lid Release



B540A01NF

To open the trunk lid without using the key, pull up the lid release lever.  
To close, lower the trunk lid, then press down on it until it locks. To be sure the trunk lid is securely fastened, always check by trying to pull it up again.

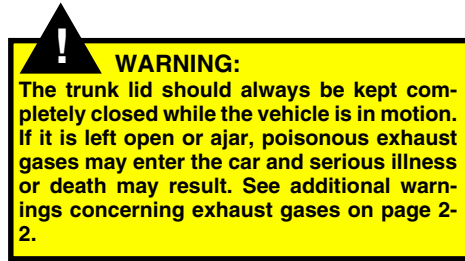

B540B04Y-AAT

### Trunk Lid Lock Knob

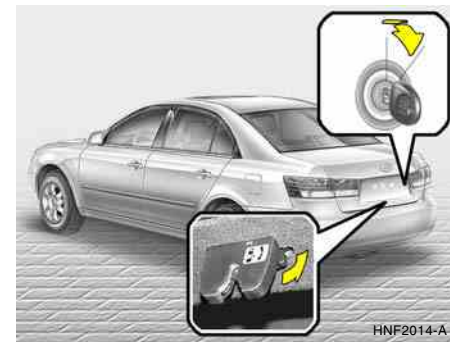

HNF2014-A

If the trunk lid lock knob (located near the latch) is in the "LOCK" position when the trunk lid is closed, it will not be possible to open the trunk

lid by using the remote release. In this instance, use the master key to unlock and open the trunk lid.

To allow the trunk lid to be opened with the remote release, push the trunk lid lock knob down, then to the opposite direction of the "LOCK" position.



**WARNING:**

Doors and trunk should be kept locked and keys be kept out of the reach of children. Parents also should teach their children about the dangers of playing in trunks.

B540B02E-AAT

**Trunk Lid Emergency Latch Release**

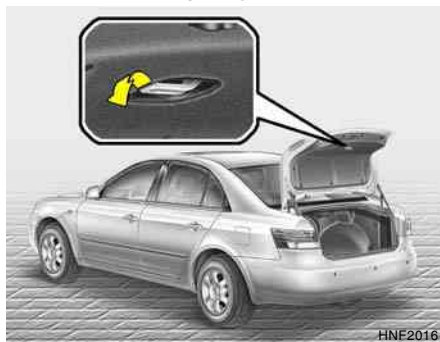

Your vehicle is equipped with a glow-in-the-dark emergency trunk release lever located inside the trunk. It will glow after the trunk is closed. When pulled, this lever will release the trunk latch mechanism and open the trunk.



**WARNING:**

- o If a person is locked in the trunk, pull the emergency trunk release lever on the driver's side of the inside panel of the trunk to open the trunk lid.
- o HYUNDAI recommends that cars be kept locked and keys be kept out of the reach of children, and that parents teach their children about the dangers of playing in trunks.
- o Parents should teach children about the emergency trunk release lever in their vehicle and how to open the trunk lid if they are accidentally locked in the trunk.

## HIGH-MOUNTED REAR STOP LIGHT

## REMOTE FUEL-FILLER LID RELEASE

B540C01Y-AAT

## To unlock using the key

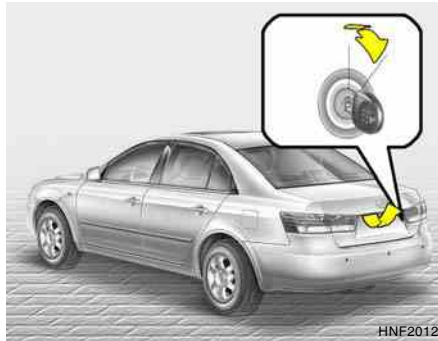

To open the trunk lid, insert the key and turn it clockwise to unlock. The trunk compartment light illuminates when the trunk lid is opened.

B550A02Y-AAT



In addition to the lower-mounted rear stop lights on either side of the car, the high mounted rear stop light in the center of the rear window also lights when the brakes are applied.

B560A03Y-AAT



The fuel-filler lid may be opened from inside the vehicle by pushing the fuel-filler lid opener switch located on the driver's door.

**NOTE:**

If the fuel-filler lid will not open because ice has formed around it, tap lightly or push on the lid to break the ice and release the lid. Do not pry on the lid. If necessary, spray around the lid with an approved de-icer fluid (do not use radiator anti-freeze) or move the vehicle to a warm place and allow the ice to melt.

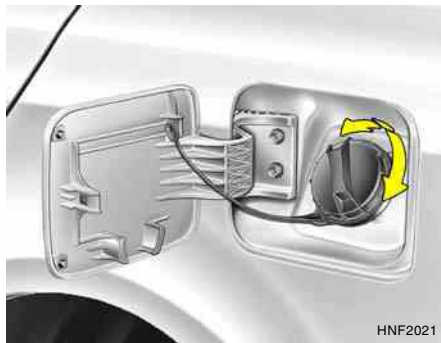

HNF2021

**WARNING:**

- o The fuel cap must be tightened until the cap clicks, otherwise "  " light will illuminate.
- o Gasoline vapors are dangerous. Before refueling, always stop the engine and never allow sparks or open flames near the filler area. If you need to replace the filler cap, use a genuine Hyundai replacement part.

**WARNING:**

- o If you open the fuel filler cap during high ambient temperatures, a slight "pressure sound" may be heard. This is normal and not a cause for concern. Whenever you open the fuel filler cap, turn it slowly.
- o Make sure the fuel filler cap is replaced and securely seated after fueling. Failure to replace or fully seat the fuel filler cap will result in fuel vapors escaping into the atmosphere and the check engine "  " indicator illuminating.
- o Do not "TOP-OFF" after the first nozzle shut off when refueling.
- o Automotive fuels are flammable/explosive materials. When refueling, please note the following guidelines carefully.
  - Before touching the fuel nozzle or fuel filler cap, have one's hands in contact with metal parts away from the filler neck to discharge static electricity.

**WARNING:**

- Do not get back in the vehicle while refueling. Do not operate anything that can produce static electricity. Static electricity discharge can ignite fuel vapors resulting in an explosion.
- When using a portable fuel container, be sure to place the container on the ground while refueling. Static electricity discharge from the container can ignite fuel vapors causing a fire. While starting refueling, contact should be maintained until the filling is complete.
- Do not use cellular phones around a gas station. The electric current or electronic interference from cellular phones can ignite fuel vapors causing a fire.
- When refueling, always turn the engine off. Sparks by engine compartment electrical equipment can ignite fuel vapors causing a fire. After refueling, check to make sure the fuel filler cap is securely closed, and then start the engine.
- Do not smoke or try to light cigarettes around a gas station. Automotive fuels are flammable.

## HOOD RELEASE

B560B01L-GAT

## Manual Fuel Filler Lid Release

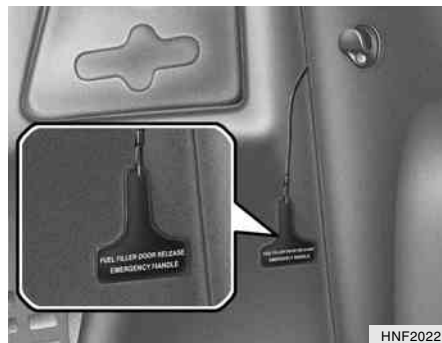

HNF2022

If the fuel filler lid cannot be opened using the remote opener, a manual opener handle is located inside the trunk on the left side. Open the fuel filler lid by pulling on this handle as shown in the illustration.

B570A01NF-GAT

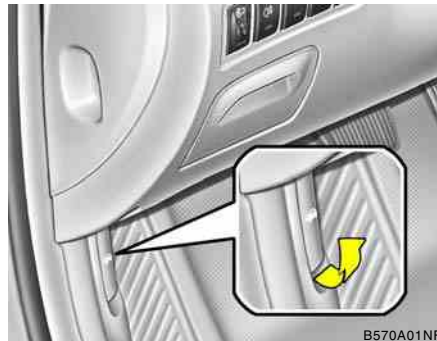

B570A01NF

1. Pull the release knob to unlatch the hood.



HNF2024-E

2. Pull the secondary latch up and lift the hood.

3. Raise the hood by hand.

When closing the hood, slowly close the hood and make sure it locks into place.

**WARNING:**

- o Always double check to be sure that the hood is firmly latched before driving away. If it is not latched, the hood could fly open while the vehicle is being driven, causing a total loss of visibility, which might result in an accident.
- o Do not move the vehicle with the hood in the raised position, as vision is obstructed and the hood could fall or be damaged.

## SUN VISOR

B580A01NF-GAT

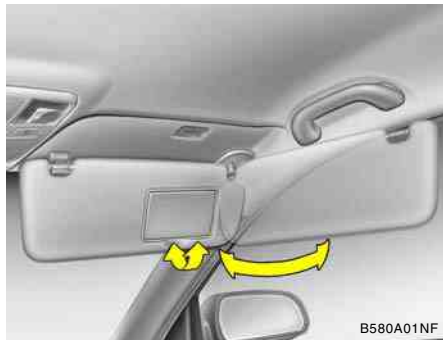

Your Hyundai is equipped with sun visors to give the driver and front passenger either frontal or sideward shade. To reduce glare or to shut out direct rays of the sun, turn the sun visor down. Vanity mirrors are provided on the back of the sun visor for the driver and front passenger.

**NOTE:**

The Supplemental Restraint System (SRS) label containing useful information can be found on the back of each sun visor.

**WARNING:**

Do not place the sun visor in such a manner that it obscures visibility of the roadway, traffic or other objects.

B500B01B-GAT

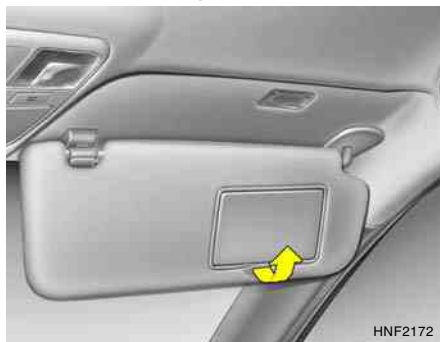
**Illuminated Vanity Mirror**

Opening the lid of the vanity mirror will automatically turn on the mirror light.

B580C01JM-AAT

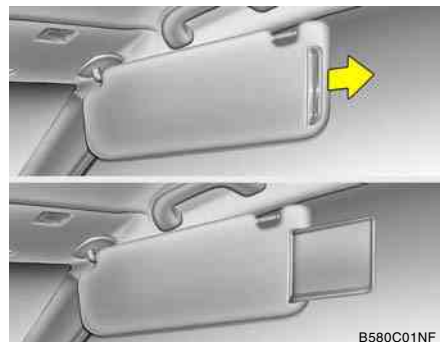
**Sun Visor Extender**

Your vehicle is equipped with sun visor extenders that may be used when the visor is in the side glass position.

## STEERING WHEEL

B600A01NF-GAT

### Tilt type



HNF2067

To adjust the steering wheel:

1. Pull the lever toward you and hold it to unlock.
2. Raise or lower the steering wheel to the desired position.
3. After adjustment, release the lever.

B600B01NF-GAT

### Tilt and telescopic type (If Installed)

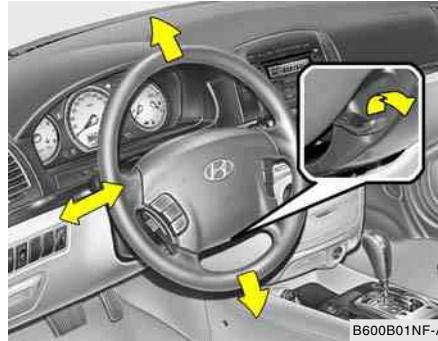

B600B01NF-A

To adjust the steering wheel:

1. Push the lever downward fully to unlock.
2. Adjust upward or downward and forward or backward to set the steering wheel to the desired position.
3. After adjustment, securely tighten the lever by pulling it upward.



#### CAUTION:

After adjusting the steering wheel, try moving it up and down to make sure it is locked in position.



#### WARNING:

Do not attempt to adjust the steering wheel while driving as this may result in loss of control of the vehicle and serious injury or death.



92

## FRONT DOOR WARNING LIGHT

B620A01S-AAT



A red light comes on when the front door is opened. The purpose of this light is to assist when you get in or out and also to warn passing vehicles.

## HORN

B610A01L-GAT



Press the pad on the steering wheel to sound the horn.

## REAR SEAT ARMREST

B611A01Y-AAT

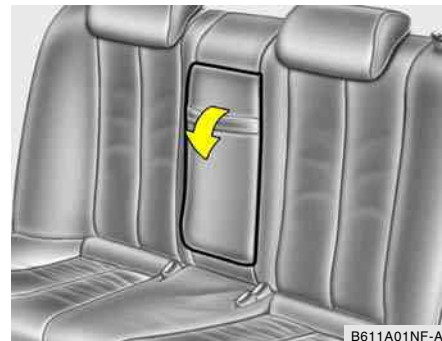

This armrest is located in the center of the rear seatback.

## CRUISE CONTROL

B660A01S-AAT

The cruise control system provides automatic speed control for your comfort when driving on freeways, tollroads, or other noncongested highways. This system is designed to function above approximately 25 mph (40 km/h).

B660B01NF-AAT

### To Set the Cruise Speed



1. Push the cruise control ON/OFF switch. The "CRUISE" indicator light in the instrument cluster will illuminate. This turns the system on.
2. Accelerate to desired cruising speed above 40 km/h (25 mph).



3. Push the "SET" (COAST) switch after you have set the vehicle speed at the desired speed.  
If the "SET (COAST)" switch is selected, the cruise "SET" indicator light in the instrument cluster will illuminate.
4. Remove your foot from the accelerator pedal and the desired speed will automatically be maintained.
5. To increase speed, temporarily depress the accelerator pedal enough for the vehicle to exceed the preset speed. When you remove your foot from the accelerator pedal, the vehicle will return to the speed you have set.

### NOTE:

If the vehicle speed decreases more than 9 mph (15 km/h) below the set speed or decreases below 25 mph (40 km/h), the cruise control system will automatically cancel the set speed.

B660C01NF-AAT

### To Cancel the Cruise Speed



To disengage the cruise control system, push the control switch "CANCEL". Additionally, the following actions will disengage the system:

- o Depress the brake pedal.
- o Depress the clutch pedal (Manual transaxle).
- o Shift the selector lever to "N" position (Automatic transaxle).
- o Decrease the vehicle speed lower than the memory speed by 9 mph (15 km/h).
- o Decrease the vehicle speed to less than 25 mph (40 km/h).
- o Release the cruise control ON/OFF switch.

B660D01NF-AAT

### To Resume the Preset Speed



The vehicle will automatically resume the speed set prior to cancellation when you push the control switch "RESUME (ACCEL)" and release it to return (when travelling above 25 mph).

If the control switch "RESUME(ACCEL)" is selected, the cruise "SET" indicator in the instrument cluster will illuminate.

B660E01NF-GAT

### To Reset at a Faster Speed

1. Push the control switch "RESUME (ACCEL)" and hold it.

If the control switch "RESUME(ACCEL)" is selected, the cruise "SET" indicator in the instrument cluster will illuminate.

2. Accelerate to desired speed and release the control switch. While the control switch is held, the vehicle will gradually gain speed.

B660F01NF-GAT

### To Reset at a Slower Speed



1. Push the control switch "SET (COAST)" and hold it. While the control switch is pushed, the vehicle speed will gradually decrease.

If the "SET(COAST)" switch is selected, the cruise "SET" indicator light in the instrument cluster will illuminate.

2. When the desired speed is obtained, release the control switch.

**WARNING:**

- o Keep the cruise control ON/OFF switch off when not using the cruise control.
- o Use the cruise control system only when traveling on open highways in good weather.
- o Do not use the cruise control when it may not be safe to keep the car at a constant speed, for instance, driving in heavy or varying traffic, or on slippery (rainy, icy or snow-covered) or winding roads or over 6% up-hill or down-hill roads.
- o Pay particular attention to the driving conditions whenever using the cruise control system.
- o During cruise-speed driving of a manual transaxle vehicle, do not shift into neutral without depressing the clutch pedal, since the engine will be overrevved. If this happens, depress the clutch pedal or release the cruise control ON/OFF switch.
- o During normal cruise control operation, when the "SET" switch is activated or reactivated after applying the brakes, the cruise control will energize after approximately 3 seconds. This delay is normal.

## AUDIO REMOTE CONTROL SWITCH

B610A01NF-AAT  
(If Installed)



B610A01NF-A

**NOTE:**

Do not operate audio remote control switches simultaneously.

**MODE Switch**

Press the MODE switch to select Radio, CD (Compact Disc) and CDC (Compact Disc Changer).

Each press of the switch changes the display as follows:

RADIO (FM1 → FM2 → AM) → CD → CDC

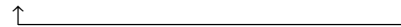
**MUTE Switch**

- o Press the MUTE switch to silence the sound.
- o Once again press the MUTE switch to restore the sound.

**VOL (▲ / ▼) Switch**

- o Press the VOL ( ▲ ) switch to increase volume.
- o Press the VOL ( ▼ ) switch to decrease volume.

## HEATING AND COOLING CONTROL

B710A01E-GAT

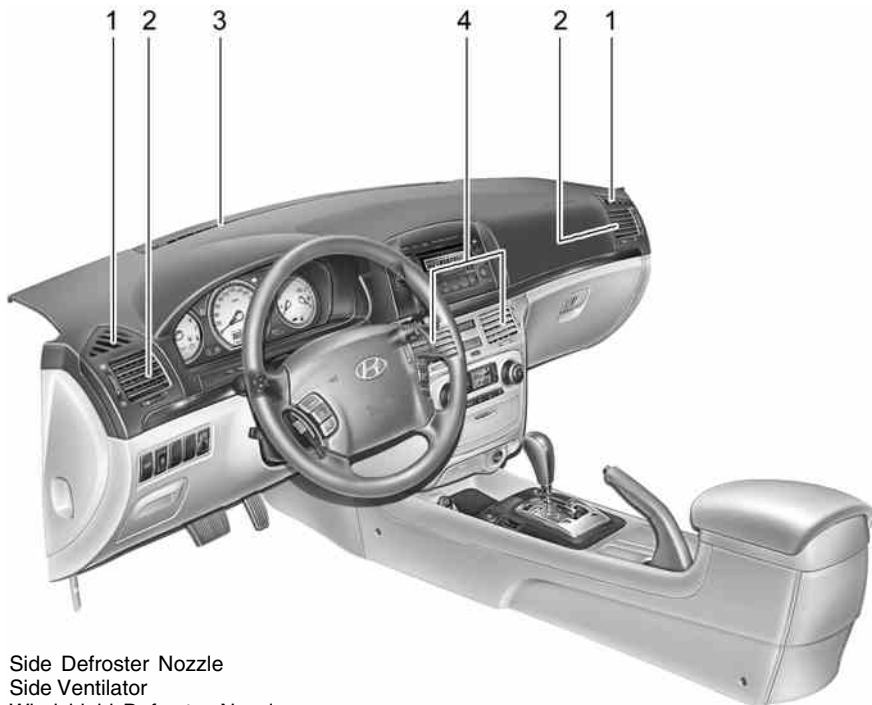

1. Side Defroster Nozzle
2. Side Ventilator
3. Windshield Defroster Nozzle
4. Center Ventilator

B710B01NF-GAT

**Center Ventilator/Side Ventilator**

The center ventilators are located in the middle of the dashboard.

The side ventilators are located on each side of the dashboard.

To change the direction of the air flow, turn the control knob under the vents.

To control the amount of air, turn the control knob on the left side of the vents. The vents are opened when the vent knob is moved to "☞" position. The vents are closed when the vent knob is moved to "☒". Keep these vents clear of any obstructions.

B710A01NF-A

## HEATING AND VENTILATION

B670A01NF-GAT

## Rotary and Push Button Type

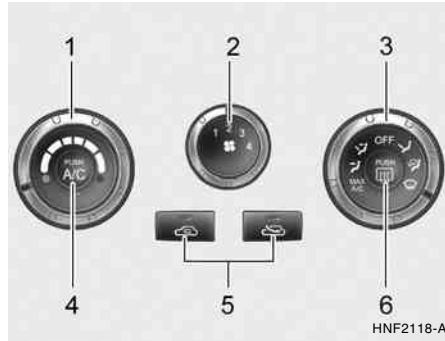

1. Temperature control
2. Fan speed control
3. Air flow control
4. Air conditioning switch
5. Air intake control
6. Rear window defroster switch

B670E01A-AAT

## Temperature Control

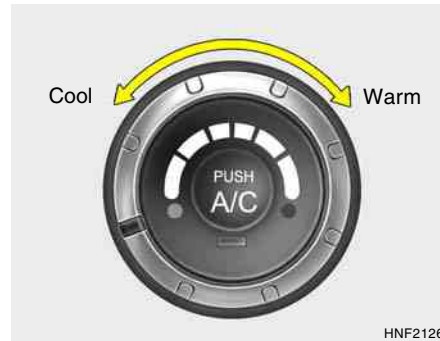

This is used to turn the heating system on and off and to select the degree of heating desired.

B670B02O-AAT

## Fan Speed Control (Blower Control)



This is used to select the blower fan speed. The blower fan speed, and therefore the volume of air delivered from the system, may be controlled manually by setting the blower control between the "1" and "4" position. 1 is the lowest fan speed and 4 is the highest fan speed.

B670D040-AAT

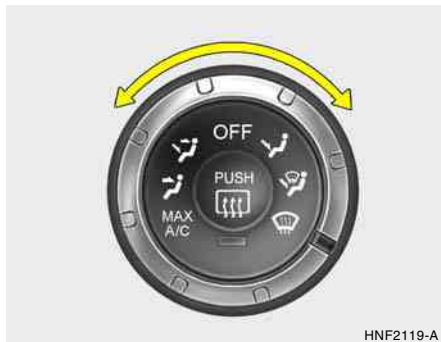
**Air Flow Control**

This is used to turn the blower fan on/off and to direct the flow of air. Air can be directed to the floor, dashboard outlets, or windshield. Five symbols are used to represent Face, Bi-Level, Floor, Floor-Defrost and Defrost air position. The MAX A/C mode is used to cool the inside of the vehicle faster. The "OFF" mode is used to turn the blower fan off.

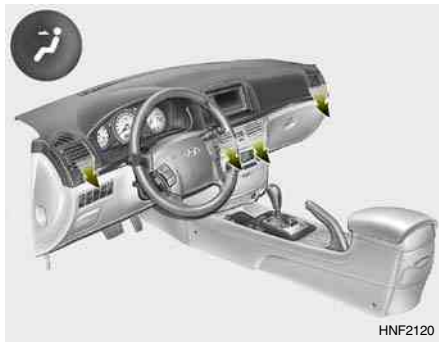
**Face-Level**

Selecting the "Face" mode will cause air to be discharged through the face level vents.

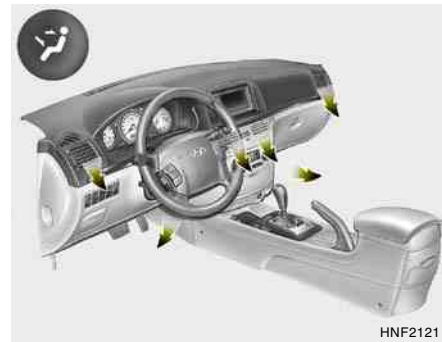
**Bi-Level**

Air is discharged through the face vents and the floor vents. This makes it possible to have cooler air from the dashboard vents and warmer air from the floor outlets at the same time.

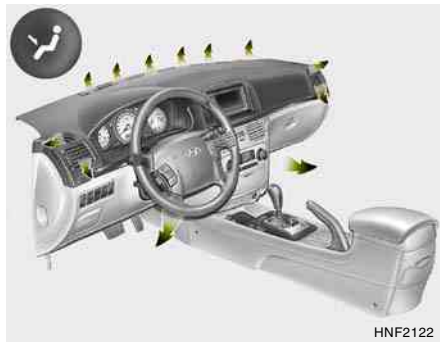

### Floor-Level

Air is discharged through the floor vents, windshield defroster nozzle, side defroster nozzle and side ventilator.

If the "Floor" mode is selected, the "Fresh" mode will be activated.

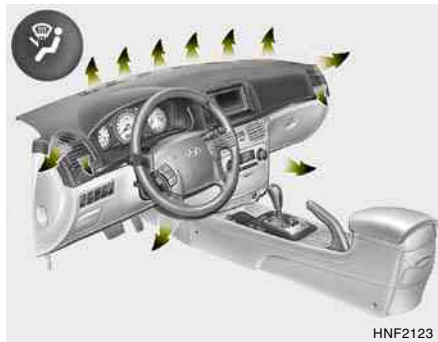

### Floor-Defrost Level

Air is discharged through the windshield defroster nozzle, the floor vents, side defroster nozzle and side ventilator.

If the "Floor-Defrost" mode is selected, the A/C will turn on automatically and "Fresh" mode will be activated.



### Defrost-Level

Air is discharged through the windshield defroster nozzle, side defroster nozzle and side ventilator.

If the "Defrost" mode is selected, the A/C will turn on automatically and "Fresh" mode will be activated to improve windshield defrosting.

#### NOTE:

**If the "Floor-Defrost" or "Defrost" mode is selected, the air conditioning will not turn off by pushing the A/C button.**



If the air flow control is set to the floor-defrost or the defrost mode, the A/C will turn on automatically but the A/C indicator light does not turn on. The A/C will not turn off until the air flow control is set to the another mode except the floor-defrost mode and the defrost mode.

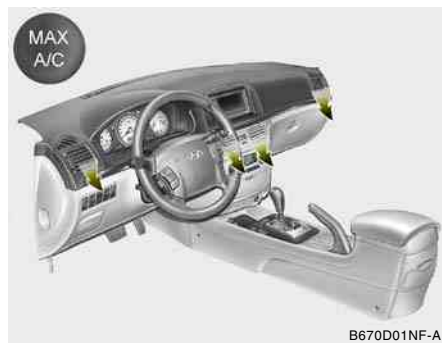

**MAX A/C-Level**

Air is discharged through the face level vents. If the "MAX A/C" mode is selected, the A/C will turn on automatically and "Recirculation" mode will be activated.

**NOTE:**

- o The air intake control switch will change to "☁️" mode when the ignition switch is turned "ON" with the MAX A/C mode selected.
- o When you change to another mode from MAX A/C, the A/C and the air intake control switch are set as shown in the following chart.

	A/C	Air Intake Control Switch
	ON	
	ON or OFF *	
<b>OFF</b>	OFF	
	ON or OFF *	
	ON	
	ON	

\* The A/C or the air intake control switch returns to its former setting.



**OFF-Level**

Air is discharged through the windshield defroster nozzle, side defroster nozzle and side ventilator.

**NOTE:**

If the air flow control is off, the air intake control is set to the fresh mode automatically.

B670C02Y-AAT

**Air Intake Control**

This is used to select fresh outside air or recirculation of inside air.



Fresh



Recirculation

With the "Fresh" mode selected, air enters the vehicle from outside and is heated or cooled according to the other functions selected.

With the "Recirculation" mode selected, air from within the passenger compartment is drawn through the heating system and heated or cooled according to the other functions selected.

**NOTE:**

- o It should be noted that prolonged operation of the heating system in "Fresh" mode will give rise to fogging of the windshield and side windows and the air within the passenger compartment will become stale. In addition prolonged use of the air conditioning with the "Fresh" mode selected may result in the air within the passenger compartment becoming excessively dry.
- o When the ignition switch is turned "ON" the air intake control switch will change to "Recirculation" mode in floor, floor-defrost and defrost position. This is normal operation. But, the air intake control switch will change to "Fresh" mode when the ignition switch is turned "ON" with the MAX A/C mode selected.

B690A01O-AAT



B690A01NF-A

For normal heating operation, set the air flow control to the floor (FLOOR) position. (The "Fresh" mode will be activated.)

For faster heating, the air intake control switch should be set in the recirculate (RECIRCULATION) position.

If the windows fog up, set the air flow control to the defrost (DEFROST) position (The A/C will turn on automatically and "Fresh" mode will be activated.)

For maximum heat, move the temperature control to "Warm".

102 BI-LEVEL HEATING

B700A02A-AAT



Your Hyundai is equipped with bi-level heating controls. This makes it possible to have cooler air from the dashboard vents and warmer air from the floor outlets at the same time. To use this feature:

- o Set the air intake control switch to the fresh air (🌬️) position.
- o Set the air flow control at the bi-level (👤👤) position.
- o Adjust the fan speed control to the desired speed.
- o Set the temperature control between "Cool" and "Warm".

VENTILATION

B710A01A-AAT



To operate the ventilation system:

- o Set the air intake control to the fresh air (🌬️) position.
- o To direct all intake air to the dashboard vents, set the airflow control to the face (👤) position.
- o Adjust the fan speed control to the desired speed.
- o Set the temperature control between "Cool" and "Warm".

B730A01L-AAT

Operation Tips

- o To keep dust or unpleasant fumes from entering the car through the ventilation system, temporarily set the air intake control at the (🌬️) position. Be sure to return the control to the (👤) position when the irritation has passed to keep fresh air in the vehicle. This will help keep the driver alert and comfortable.
- o Air for the heating/cooling system is drawn in through the grilles just ahead of the windshield. Care should be taken that these are not blocked by leaves, snow, ice or other obstructions.
- o To prevent interior fog on the windshield, set the air intake control to the fresh air (🌬️) position and fan speed to the desired position, turn on the air conditioning system, and adjust temperature control to desired temperature.

## AIR CONDITIONING SYSTEM

B740A01S-AAT

**Air Conditioning Switch  
(If Installed)**

HNF2128-A

The air conditioning is turned on or off by pushing the A/C button on the heating/air conditioning control panel.

B740B03O-AAT

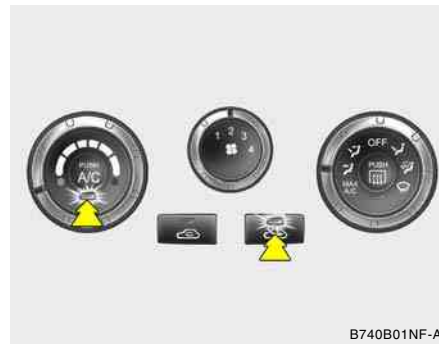
**Air Conditioning Operation  
Cooling**

B740B01NF-A

To use the air conditioning to cool the interior:

- o Set the air flow control to the face ( ) position.
- o Turn on the air conditioning switch by pushing in on the switch. The air conditioning indicator light should come on at the same time.
- o Set the air intake control to the fresh air ( ) position.

- o Set the temperature control to "Cool". ("Cool" provides maximum cooling. The temperature may be moderated by moving the control toward "Warm".)
- o Adjust the fan control to the desired speed. For greater cooling, turn the fan control to one of the higher speeds or temporarily select the recirculate ( ) position on the air intake control.

B740C02O-AAT

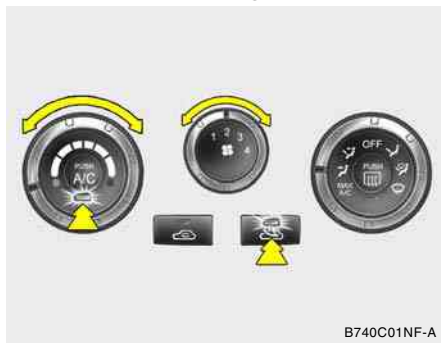
**De-Humidified Heating**

For dehumidified heating:

- o Set the air flow control to the face (☺) position.
- o Turn on the air conditioning switch. The air conditioning indicator light should come on at the same time.
- o Set the air intake control to the fresh air (☞) position.
- o Adjust the fan control to the desired speed.
- o For more rapid action, set the fan at one of the higher speeds.
- o Adjust the temperature control to provide the desired amount of warmth.

B740D02Y-AAT

**Operation Tips**

- o If the interior of the car is hot when you first get in, open the windows for a few minutes to expel the hot air.
- o When you are using the air conditioning system, keep all windows closed to keep hot air out.
- o When moving slowly, as in heavy traffic, shift to a lower gear. This increases engine speed, which in turn increases the speed of the air conditioning compressor.
- o On steep grades, turn the air conditioning off to avoid the possibility of the engine overheating.
- o During winter months or in periods when the air conditioning is not used regularly, run the air conditioning once every month for a few minutes. This will help circulate the lubricants and keep your system in peak operating condition.

## DEFROSTING/DEFOGGING

B720A02E-AAT



B720A01NF-A



B720A02NF-A

Use the heating/ventilation system to defrost or defog the windshield:

### To remove interior fog on the windshield;

- o Set the air flow control to the defrost (  ) position. (The A/C will turn on automatically and the "Fresh" mode will be activated.)
- o Set the temperature control to the desired position.
- o Set the fan speed control between "1" and "4" position.

### NOTE:

When the A/C is operated continuously on the floor-defrost level (  ) or defrost level (  ), it may cause fog to form on the exterior windshield. If this occurs, set the air flow control to the face level position (  ) and fan speed control to the low position.

### To remove frost or exterior fog on the windshield;

- o Set the air flow control to the defrost (  ) position. (The A/C will turn on automatically and the "Fresh" mode will be activated.)
- o Set the temperature control to warm.
- o Set the fan speed control to position "3" or "4".

**AUTOMATIC HEATING AND COOLING CONTROL SYSTEM**

B970A01Y-AAT  
**(If Installed)**

Your Hyundai is equipped with an automatic heating and cooling control system controlled by simply setting the desired temperature.

B970B01NF-GAT

**Heating and Cooling Controls**

1. Temperature Control
2. Defroster Switch
3. Display Window
4. Rear Window Defroster Switch
5. Blower Fan Control
6. AUTO (Automatic Control) Switch
7. Air Flow Control Switch
8. Air Conditioning Switch
9. Air Intake Control Switch
10. Air Quality System Switch (If Installed)
11. OFF Switch

**TYPE A (Without Air Quality System)**



B970B01NF

**TYPE B (With Air Quality System)**



B970B02NF

B970C01NF-AAT

## Automatic Operation

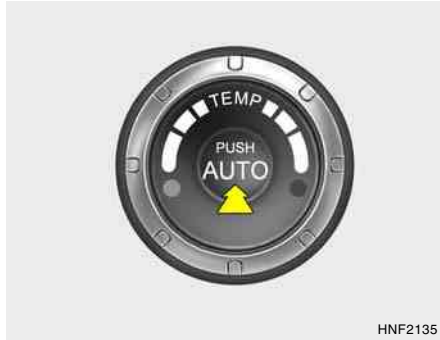

HNF2135

The FATC (Full Automatic Temperature Control) system automatically controls heating and cooling as follows:

1. Push the "AUTO" switch. The indicator light will illuminate confirming that the Face, Floor and/or Bi-Level modes as well as the blower speed and air conditioner will be controlled automatically. And, the air conditioning will operate if ambient temperature is higher than 34.7°F(1.5°C) and automatically turns off if the ambient temperature drops below 33.08°F(0.6°C).

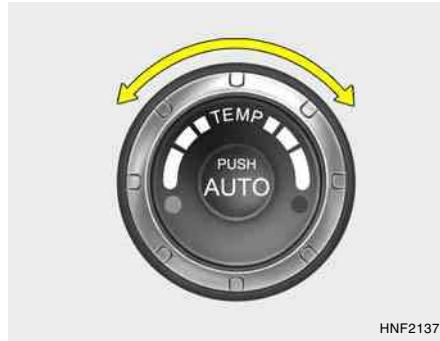

HNF2137

2. Turn the "TEMP" knob to set the desired temperature. The temperature will increase to the maximum "HI" by turning the knob clockwise. The temperature will decrease to the minimum "LO" by turning the knob counter-clockwise.

### NOTE:

If the battery has been discharged or disconnected, the temperature mode will reset to Centigrade degrees.

This is a normal condition and you can change the temperature mode from Centigrade to Fahrenheit as follows; Press the "OFF" and "AUTO" button simultaneously for 3 seconds.

The display shows that the unit of temperature is adjusted to Centigrade or Fahrenheit (°C → °F or °F → °C).



B970C01NF-A

### NOTE:

Never place anything over the sensor which is located on the instrument panel to ensure better control of the heating and cooling system.



B980A01Y-AAT

**MANUAL OPERATION**

The heating and cooling system can be controlled manually as well by pushing buttons other than the "AUTO" button. In this state, the system sequentially works according to the order of buttons selected.

The function of the buttons which are not selected will be controlled automatically.

Press the "AUTO" button in order to convert to automatic control of the system.

B980B01NF-GAT

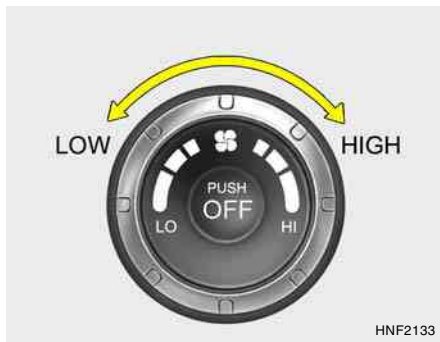
**Fan Speed Control**

The fan speed can be set to the desired speed by turning the fan speed control knob. The higher the fan speed is, the more air is delivered. Pressing the "OFF" button turns off the fan.

B670C02Y-AAT

**Air Intake Control Switch (Without A.Q.S)**

This is used to select fresh outside air or recirculation of inside air.

To change the air intake control mode (Fresh mode, Recirculation mode), push the control button.

**FRESH MODE** (  ): The indicator light on the button goes on when the air intake control is in fresh mode.

**RECIRCULATION MODE** (  ): The indicator light on the button is illuminated when the air intake control is in recirculation mode.

With the "Fresh" mode selected, air enters the vehicle from the outside and is heated or cooled according to the function selected.

With the "Recirculation" mode selected, air from within the passenger compartment will be drawn through the heating system and heated or cooled according to the function selected.

#### NOTE:

- o It should be noted that prolonged operation of the heating system in "recirculation" mode will give rise to fogging of the windshield and side windows and the air within the passenger compartment will become stale. In addition, prolonged use of the air conditioning with the "Recirculation" mode selected may result in the air within the passenger compartment becoming excessively dry.
- o When the ignition switch is turned "ON" the air intake control will change to "Fresh" mode (regardless of switch position). This is normal operation. The air intake control operates in "AUTO" mode when turning the ignition to the ON position if the "AUTO" mode was used before shutting off the engine.

B980C03Y-GAT

#### Air Intake Control Switch (With A.Q.S) (If Installed)



This is used to select fresh outside air or recirculate inside air automatically.

- ☐ : OFF
- ▬ : ON

☐ ☐  
☐ (A) **Fresh mode :**

Air enters the vehicle from the outside and is heated or cooled according to the function selected.

☐ ☐  
☐ (A) **Recirculation mode :**

Air from within the passenger compartment will be drawn through the heating system and heated or cooled according to the function selected.

☐ ☐  
☐ (A) **Exhaust gas cutoff mode :**

Air enters the vehicle from the outside. But if exhaust gas enters the vehicle from the outside, the exhaust gas cutoff mode (☐ (A)) is automatically converted to the (☐ (A)) mode, to prevent exhaust gas from entering the vehicle.

#### NOTE:

- o It should be noted that prolonged operation of the heating system in recirculation mode (☐ (A)) will give rise to misting of the windshield and side windows and the air within the passenger compartment will become stale. In addition, prolonged use of the air conditioning with the recirculation mode (☐ (A)) selected may result in the air within the passenger compartment becoming excessively dry.
- o When the ignition switch is turned "ON", the air intake control will change to "Fresh" mode (regardless of switch position). This is normal operation. The air intake control operates in "AUTO" mode when turning the ignition to the ON position if the "AUTO" mode was used before shutting off the engine.



**CAUTION:**

If the windows fog up with the Recirculation or A.Q.S mode selected, set the air intake control to the Fresh air position or A.Q.S control to "OFF".

B980D01Y-AAT

**Heating and Cooling System Off**



HNF2143

Press the "OFF" button to stop the operation of the heating and cooling system.

B980E01NF-GAT

**Air Flow Control**



B980E01NF-A

This is used to direct the flow of air. Air can be directed to the floor, dashboard outlets, or windshield. Four symbols are used to represent Face, Bi-Level, Floor, Floor-Defrost position.

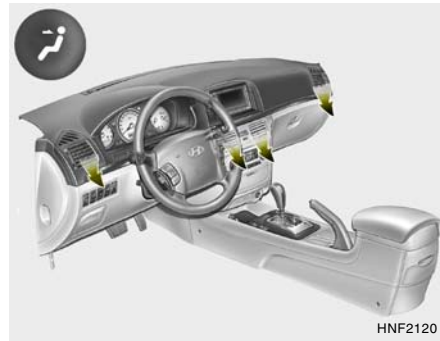

HNF2120



**Face-Level**

When selecting the "Face-Level" mode, the indicator light will come on, causing air to be discharged through the face level vents.

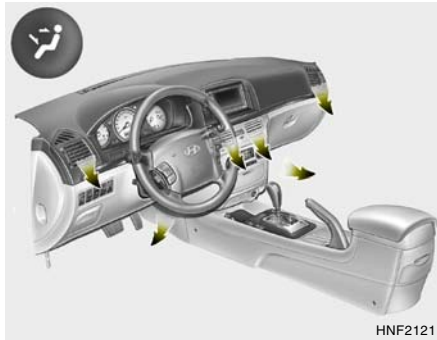

### Bi-Level

When selecting the "Bi-Level", the indicator light will come on and the air will be discharged through the face vents and the floor vents. This makes it possible to have cooler air from the dashboard vents and warmer air from the floor outlets at the same time.

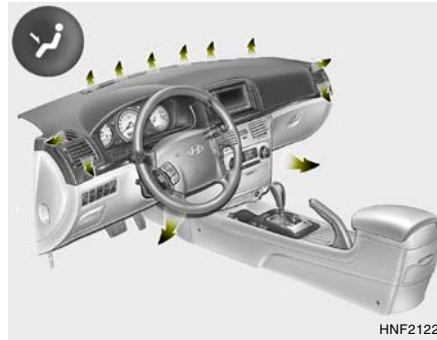

### Floor-Level

When selecting the "Floor-Level", the indicator light will come on and the air will be discharged through the floor vents, windshield defroster nozzle, side defroster nozzle and side ventilator.

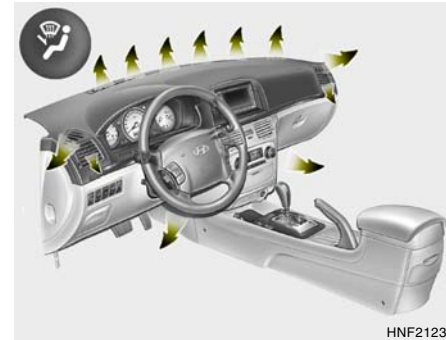

### Floor-Defrost Level

When selecting the "Floor-Defrost" mode, the indicator light will come on and the air will be discharged through the windshield defroster nozzle, the floor vents, side defroster nozzle and side ventilator.

If any of the temperature control switch, the blower fan control switch, or the defrost switch is selected in "Floor-Defrost" mode, the A/C will turn on automatically and "Fresh" mode will be activated.

B980F01NF-AAT

### Defrost Switch



B980F01NF-A

When the "Defrost" button is pressed, the "☀️" mode will be automatically selected and the air will be discharged through the windshield defroster nozzle, side defroster nozzle and side ventilator. To assist in defrosting, the air conditioning will operate if ambient temperature is higher than 34.7°F(1.5°C) and automatically turns off if the ambient temperature drops below 33.08°F(0.6°C).

B980G01NF-AAT

### Auto De-humidified Control (If Installed)

There is a humidity sensor in the middle of the instrument panel. If it is very humid inside the car, the air conditioning is turned on automatically to control the humidity.

B760A01NF-AAT

### AIR CONDITIONER FILTER (FOR EVAPORATOR AND BLOWER UNIT) (If Installed)

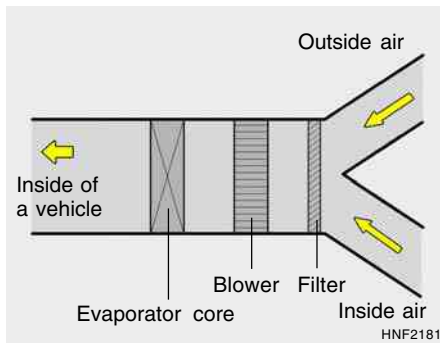

The air conditioner filter is located in the right side of the instrument panel.

It operates to decrease the amount of pollutants entering the car.

To replace the air conditioner filter, refer to page 6-22.



#### CAUTION:

- o Replace the filter every 10,000 miles (15,000 km) or once a year. If the car is being driven in severe conditions such as dusty, rough roads, more frequent air conditioner filter inspections and changes are required.
- o When the air flow rate is suddenly decreased, it must be checked at an authorized dealer.

## STEREO SOUND SYSTEM

B750A02A-AAT

### How Car Audio Works

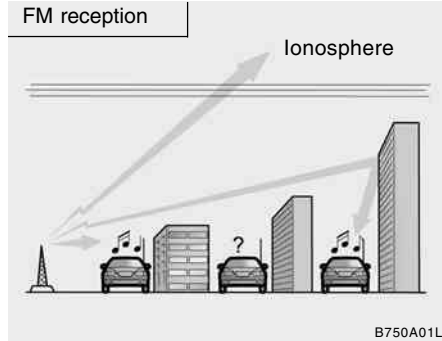

AM and FM radio signals are broadcast from transmitter towers located around your city. They are intercepted by the radio antenna on your car. This signal is then received by the radio and sent to your car speakers.

When a strong radio signal has reached your vehicle, the precise engineering of your audio system ensures the best possible quality reproduction. However, in some cases the signal coming to your vehicle may not be strong and clear. This can be due to factors such as the distance from the radio station, closeness of other strong radio stations or the presence of buildings, bridges or other large obstructions in the area.

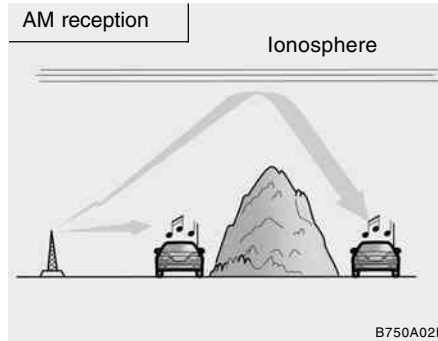

AM broadcasts can be received at greater distances than FM broadcasts. This is because AM radio waves are transmitted at low frequencies. These long, low frequency radio waves can follow the curvature of the earth rather than travelling straight out into the atmosphere. In addition, they curve around obstructions so that they can provide better signal coverage.

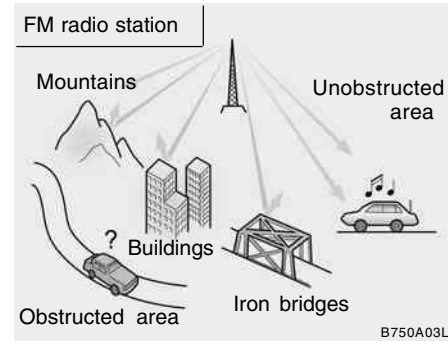

FM broadcasts are transmitted at high frequencies and do not bend to follow the earth's surface. Because of this, FM broadcasts generally begin to fade at short distances from the station. Also, FM signals are easily affected by buildings, mountains, or other obstructions. These can result in certain listening conditions which might lead you to believe a problem exists with your radio. The following conditions are normal and do not indicate radio trouble:

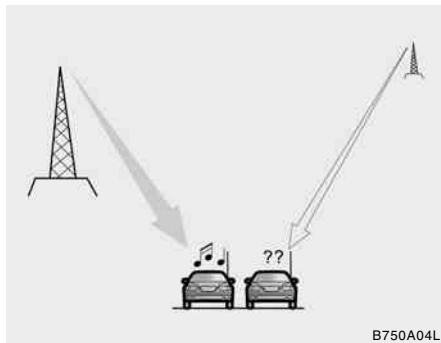

B750A04L

- o Fading - As your car moves away from the radio station, the signal will weaken and sound will begin to fade. When this occurs, we suggest that you select another stronger station.
- o Flutter/Static - Weak FM signals or large obstructions between the transmitter and your radio can disturb the signal causing static or fluttering noises to occur. Reducing the treble level may lessen this effect until the disturbance clears.

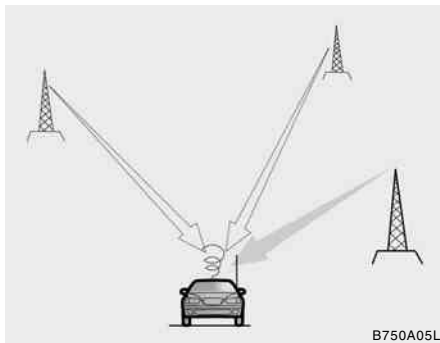

B750A05L

- o Station Swapping - As an FM signal weakens, another more powerful signal near the same frequency may begin to play. This is because your radio is designed to lock onto the clearest signal. If this occurs, select another station with a stronger signal.
- o Multi-Path Cancellation - Radio signals being received from several directions can cause distortion or fluttering. This can be caused by a direct and reflected signal from the same station, or by signals from two stations with close frequencies. If this occurs, select another station until the condition has passed.

B750B04Y-AAT

### Using a cellular phone or a two-way radio

When a cellular phone is used inside the vehicle, noise may be produced from the audio equipment. This does not mean that something is wrong with the audio equipment. In such a case, use the cellular phone at a place as far as possible from the audio equipment.



#### WARNING:

**Don't use a cellular phone when you are driving. This could result in loss of control, and an accident that may cause death, serious injury, or property damage. You must stop at a safe place to use a cellular phone.**

## AUDIO SYSTEM

V480A01NF-AAT

## STEREO RADIO OPERATION (V480) (If Installed)

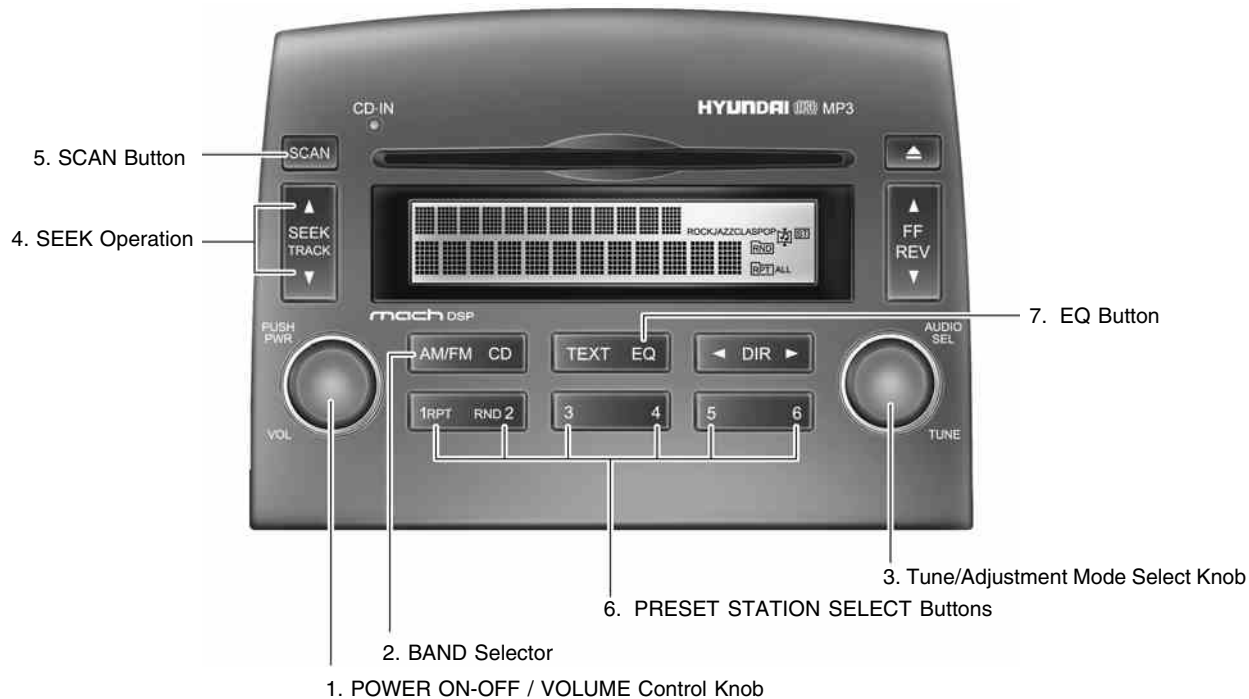



V480B01NF-AAT

## 1. POWER ON-OFF / VOLUME Control Knob

Press the PUSH PWR Control Knob to turn the audio system on or off.

Rotate the knob clockwise to increase the volume and turn the knob counterclockwise to decrease the volume.

If the volume is set above a certain level and the ignition is turned off, the volume will come back on at a "nominal" listening level when the ignition switch is turned back on.

## 2. BAND Selector

The AM/FM select control works in radio and CD mode.

### o AM/FM select in radio mode

This control allows you to select AM or FM frequency bands. Press the button to switch between FM1, FM2 and AM memory preset stations.

### o AM/FM select in CD mode

Press this button to stop CD play and begin radio play.

## 3. Tune(manual) / Adjustment Mode Select Knob

- o Rotate counterclockwise to the next frequency down the band (whether or not a listenable station is located there).
- o Rotate clockwise to move to the next frequency up the band (whether or not a listenable station is located there).

### Adjustment Mode Select

Pressing the AUDIO SEL knob will initiate Audio Mode. Each subsequent press will select the next adjustment in the following order:

- 1) Bass adjust  
The bass adjust control allows you to increase or decrease the audio system's bass output. Rotate the AUDIO SEL knob to change the bass setting.
- 2) Midrange adjust  
The midrange adjust control allows you to increase or decrease the audio system's midrange output. Rotate the AUDIO SEL knob to change the midrange setting.
- 3) Treble adjust  
The treble adjust control allows you to increase or decrease the audio system's treble output. Rotate the AUDIO SEL knob to change the treble setting.

- 4) Speaker balance adjust  
Speaker sound distribution can be adjusted between the right and left speakers by rotating the AUDIO SEL knob.
- 5) Speaker fade adjust  
Speaker sound can be adjusted between the front and rear speakers by rotating the AUDIO SEL knob.

## 4. SEEK Operation (Automatic Channel Selection)

- o Press ▼ (down arrow) to find the next listenable station down the frequency band. SEEK DOWN will display.
- o Press ▲ (up arrow) to find the next listenable station up the frequency band. SEEK UP will display.

## 5. SCAN Button

Press the SCAN button to hear a brief sampling of all listenable stations on the frequency band. Press the SCAN button again to stop the scan mode.

## 6. PRESET STATION SELECT Buttons

The radio is equipped with six preset station memory controls. These buttons can be used to select up to 6 preset AM stations and 12 preset FM stations (six in AM, six in FM1, six in FM2). There are a total possible of 18 preset stations.

### Setting memory preset stations

- o Select the frequency band with the BAND selector. Press the AM/FM control to toggle between AM, FM1, or FM2.
- o Press the SEEK control to access the next listenable station up or down the frequency band. Rotate the TUNE control to go up or down the listening band in individual increments.
- o Select a station.
- o Press and hold a memory preset control. You will hear a beep and the station is held in memory on the control you selected.

## 7. EQ Button- Equalization Feature

The radio has five EQ modes: OFF, CLASSICAL, POP, ROCK, and JAZZ.

Each press of the EQ button will advance to the next EQ setting. Radio and CD have independent EQ settings.



### CAUTION:

- o Do not place beverages close to the audio system. The playback mechanism may be damaged if you spill them.
- o Do not impact or strike the audio system, or the playback mechanism could be damaged.

V480C01NF-AAT

**COMPACT DISC PLAYER OPERATION (V480) (If Installed)**

**- Compatible with MP3**

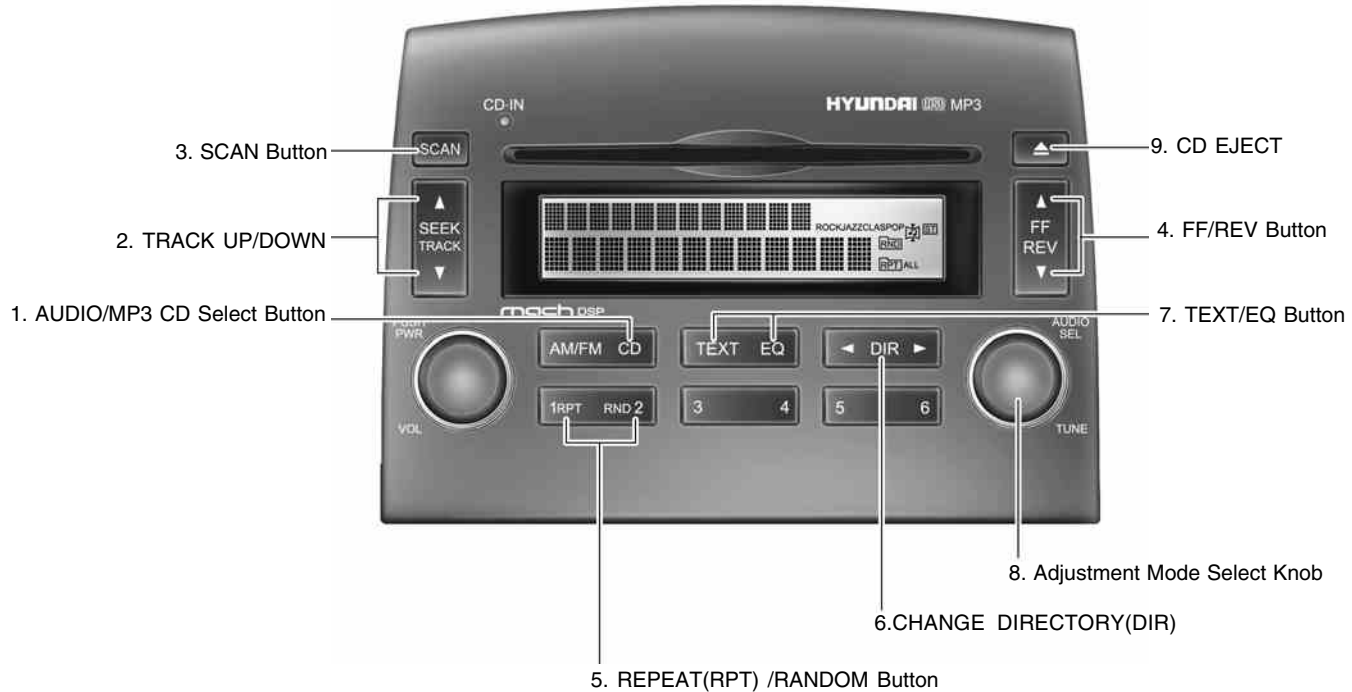

V480C01NF-AAT

## 1. AUDIO/MP3 CD Select Button

CD mode may be entered by pressing the CD button and then loading a CD into the audio system. The first track of the disc will begin playing. After that, the CD play will begin where it stopped last.

NO CD will display if the CD control is activated when there is not a CD present in the audio system.

### NOTE:

- o Do not apply paper, tape, etc., onto the label side or the recording side of any discs, as it may cause a malfunction.
- o The unit cannot play a CD-R(Recordable CD) and CD-RW(Rewritable CD) that is not finalized. Please refer to the manual of the CD-R/CD-RW recorder or CD-R/CD-RW software for more information on the finalization process.
- o Depending on the recording status, some CD-Rs/CD-RWs may not be playable on this unit.

## 2. TRACK UP/DOWN

- o Press ▼ (down arrow) to revert to the previous track of the current disc. If the beginning of the disc is reached, the CD player seeks to the beginning of the last track on the current disc and begins playing.
- o Press ▲(up arrow) to advance to the next track of the current disc. After the last track has been completed, the first track of a current disc will automatically replay.

## 3. SCAN Button

Press the SCAN button to hear a short sampling of all selections on the CD. (The CD scans in a forward direction, wrapping back to the first track at the end of the CD.) To stop on a particular selection, press the button again.

## 4. FF/REV

- o Press and hold the FF button until the desired selection is reached. Release the button to disengage fast forward mode. When in fast forward mode, your audio system will automatically lower the volume level of the playing media.

- o Press and hold the REV button until the desired selection is reached. If the beginning of the disc is reached, the CD will begin play at the first track. Release the button to disengage reverse mode. When in reverse mode, your audio system will automatically lower the volume level of the playing media.

## 5. REPEAT(RPT)

When engaged, the repeat feature has three different modes: RPT Track, RPT DIR, RPT OFF.

RPT Track will continuously play the current track selected. RPT DIR will continuously play the current MP3 directory.

- o Press the RPT control until the desired repeat mode is displayed. The audio system will then engage the desired repeat mode.

## RANDOM(RND)

When engaged, the random feature has three different modes: Random Disc, Random Directory (MP3 only), and Random Off.

RANDOM DISC randomly plays tracks from the disc presently in the audio system. RANDOM DIRECTORY plays all the tracks on the current MP3 directory in random order.

- o Press the RND button until the desired shuffle mode is displayed. The audio system will then engage the desired random mode.

## 6. CHANGE DIRECTORY(DIR)

Press DIR control to change MP3 directories.

## 7. MP3 TEXT mode

Each press of the TEXT button will advance through the following MP3 track information:

- 1) Filename
- 2) Song Title
- 3) Artist Name
- 4) Album Name
- 5) Directory Name
- 6) Number of tracks on the current disc

Rotate the AUDIO-SEL knob to view additional characters.

## EQ Button - Equalization Feature

The Compact disc player has five EQ modes: OFF, CLASSICAL (CLAS), POP, ROCK, and JAZZ.

Each press of the EQ button will advance to the next EQ setting. Radio and CD have independent EQ settings.

## 8. Adjustment Mode Select Knob

Pressing the AUDIO SEL knob will initiate Audio Mode. Each subsequent press will select the next adjustment in the following order:

- 1) Bass adjust  
The bass adjust control allows you to increase or decrease the audio system's bass output. Rotate the AUDIO SEL knob to change the bass setting.
- 2) Midrange adjust  
The midrange adjust control allows you to increase or decrease the audio system's midrange output. Rotate the AUDIO SEL knob to change the midrange setting.
- 3) Treble adjust  
The treble adjust control allows you to increase or decrease the audio system's treble output. Rotate the AUDIO SEL knob to change the treble setting.
- 4) Speaker balance adjust  
Speaker sound distribution can be adjusted between the right and left speakers by rotating the AUDIO SEL knob.
- 5) Speaker fade adjust  
Speaker sound can be adjusted between the front and rear speakers by rotating the AUDIO SEL knob.

## 9. CD EJECT

- o Press the EJ button to stop and eject a CD. If a CD is ejected and not removed, the player will automatically reload the CD. This feature may be used when the ignition is ON or OFF.

### NOTE:

- o **To assure proper operation of the unit, keep the vehicle interior temperature within a normal range by using the vehicle's air conditioning or heating system.**
- o **When replacing the fuse, replace it with a fuse having the correct capacity.**
- o **This equipment is designed to be used only in a 12 volt DC battery system with negative ground.**
- o **This unit is made of precision parts. Do not attempt to disassemble or adjust any parts.**
- o **When driving your vehicle, be sure to keep the volume of the unit set low enough to allow you to hear sounds coming from the outside.**
- o **Do not expose this equipment (including the speakers) to water or excessive moisture.**

**CAUTION:**

- o Do not insert warped or poor quality discs into the CD player as damage to the unit may occur.
- o Do not insert anything like coins into the player slot as damage to the unit may occur.
- o Do not place beverages close to the audio system. The playback mechanism may be damaged if you spill them.
- o Do not impact or strike the audio system, or the playback mechanism could be damaged.
- o Driving off-road or other vibrations may skip your compact disc. Do not use the audio system off-road as the discs could be scratched and damaged.
- o Do not grip or pull out the disc with your hand while the disc is being pulled into the unit by the self loading mechanism. These can cause poor disc scratching to occur or damage the compact disc player.
- o Avoid using CD-Recordable or CD Rewritable to ensure proper operation. When using the compact disc player, professionally recorded CDs are recommended.

V490A01NF-AAT

**STEREO RADIO OPERATION (V490) (If Installed)**

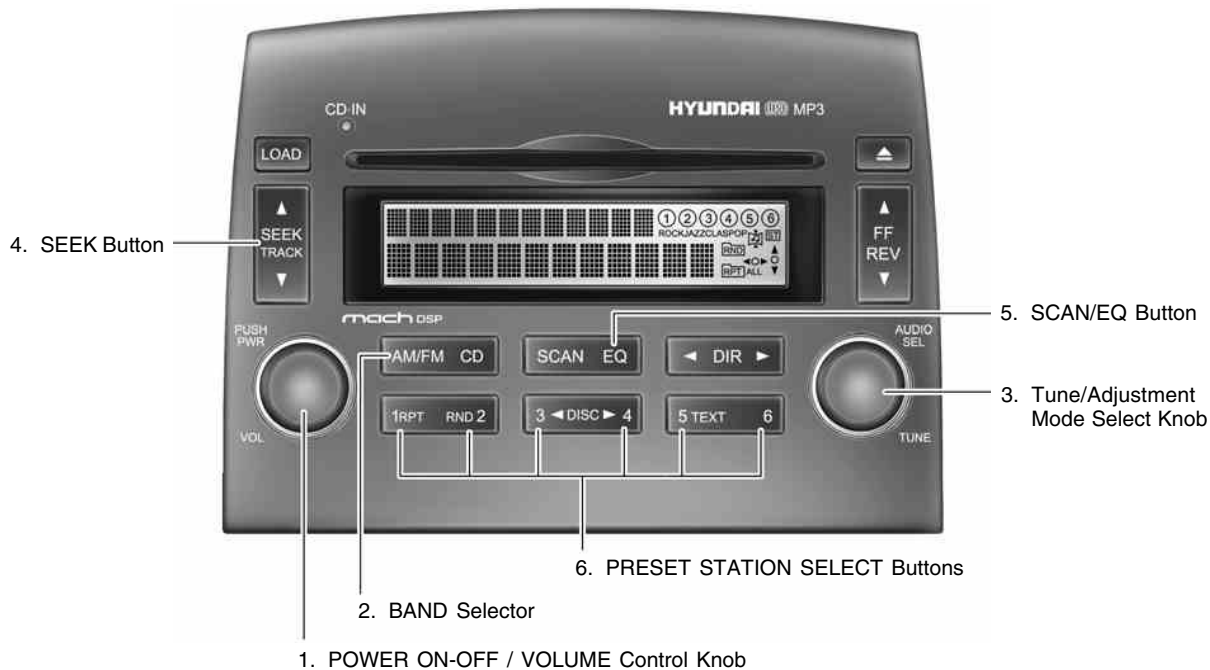

V490B01NF-AAT

## 1. POWER ON-OFF / VOLUME Control Knob

Press the PUSH PWR Control Knob to turn the audio system on or off.

Rotate the knob clockwise to increase the volume and turn the knob counterclockwise to decrease the volume.

If the volume is set above a certain level and the ignition is turned off, the volume will come back on at a "nominal" listening level when the ignition switch is turned back on.

## 2. BAND Selector

The AM/FM select control works in radio and CD modes.

### o AM/FM select in radio mode

This control allows you to select AM or FM frequency bands. Press the button to switch between FM1, FM2 and AM memory preset stations.

### o AM/FM select in CD mode

Press this button to stop CD play and begin radio play.

## 3. Tune(manual) / Adjustment Mode Select Knob

- o Rotate counterclockwise to the next frequency down the band (whether or not a listenable station is located there).
- o Rotate clockwise to move to the next frequency up the band (whether or not a listenable station is located there).

### Adjustment Mode Select

Pressing the AUDIO SEL knob will initiate Audio Mode. Each subsequent press will select the next adjustment in the following order:

- 1) Bass adjust  
The bass adjust control allows you to increase or decrease the audio system's bass output. Rotate the AUDIO SEL knob to change the bass setting.
- 2) Midrange adjust  
The midrange adjust control allows you to increase or decrease the audio system's midrange output. Rotate the AUDIO SEL knob to change the midrange setting.
- 3) Treble adjust  
The treble adjust control allows you to increase or decrease the audio system's treble output. Rotate the AUDIO SEL knob to change the treble setting.

- 4) Speaker balance adjust  
Speaker sound distribution can be adjusted between the right and left speakers by rotating the AUDIO SEL knob.
- 5) Speaker fade adjust  
Speaker sound can be adjusted between the front and rear speakers by rotating the AUDIO SEL knob.

## 4. SEEK Operation (Automatic Channel Selection)

- o Press ▼ (down arrow) to find the next listenable station down the frequency band. SEEK DOWN will display.
- o Press ▲ (up arrow) to find the next listenable station up the frequency band. SEEK UP will display.

## 5. SCAN EQ Button

Press the SCAN button to hear a brief sampling of all listenable stations on the frequency band. Press the SCAN button again to stop the scan mode.



## EQ Button- Equalization Feature

The radio has five EQ modes: OFF, CLASSICAL, POP, ROCK, and JAZZ.

Each press of the EQ button will advance to the next EQ setting. Radio and CD have independent EQ settings.

## 6. PRESET STATION SELECT Buttons

The radio is equipped with six preset station memory controls. These buttons can be used to select up to 6 preset AM stations and 12 preset FM stations (six in AM, six in FM1, six in FM2). There are a total possible of 18 preset stations.

### Setting memory preset stations

- o Select the frequency band with the BAND selector. Press the AM/ FM control to toggle between AM, FM1, or FM2.
- o Press the SEEK control to access the next listenable station up or down the frequency band. Rotate the TUNE control to go up or down the listening band in individual increments.
- o Select a station.
- o Press and hold a memory preset control. You will hear a beep and the station is held in memory on the control you selected.



### CAUTION:

- o Do not place beverages close to the audio system. The playback mechanism may be damaged if you spill them.
- o Do not impact or strike the audio system, or the playback mechanism could be damaged.

V490C01NF-AAT

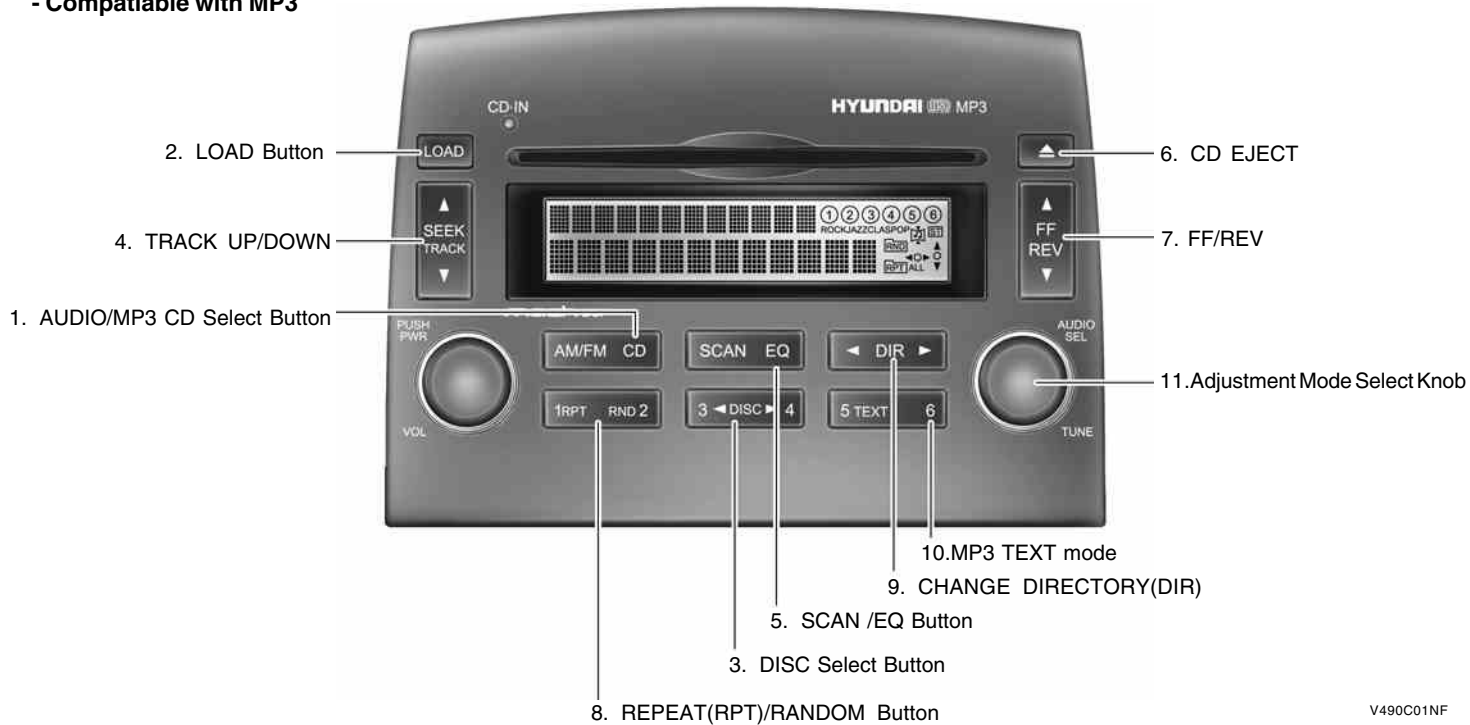
**COMPACT DISC PLAYER OPERATION (V490) (If Installed)****- Compatible with MP3**

V490D01NF-AAT

## 1. AUDIO/MP3 CD Select Button

CD mode may be entered by pressing the CD button and then loading a CD into the audio system. The first track of the disc will begin playing. After that, the CD play will begin where it stopped last.

If an alternative CD is desired, press the corresponding preset control (1- 6) of a loaded CD, or press the DISC control to access the other loaded CDs.

NO CD will display if the CD control is activated when there is not a CD present in the audio system. If the CD control is pressed followed by a preset number, and that particular slot is empty, NO CD will display and the system will begin to play the next available disc.

### NOTE:

- o **Do not apply paper, tape, etc., onto the label side or the recording side of any discs, as it may cause a malfunction.**
- o **The unit cannot play a CD-R(Recordable CD) and CD-RW(Rewritable CD) that is not finalized. Please refer to the manual of the CD-R/CD-RW recorder or CD-R/CD-RW software for more information on the finalization process.**
- o **Depending on the recording status, some CD-Rs/CD-RWs may not be playable on this unit.**

## 2. LOAD Button

The load feature allows you to load single CDs into the player internal to the audio.

- o Press the LOAD button. Wait until the CD displays the insert CD message.
- o Load the CD into the player.

### Autoload

This feature allows you to azzutoload up to six discs into the multi-disc CD player internal to the audio.

- o Press and hold the LOAD button until AUTOLOAD# is displayed.
- o Load the desired discs, one at a time. The CD is loaded into position and the audio system will display CD#. Each time the audio is ready for another CD, AUTOLOADING DISC SLOT# message will be displayed. The player will move to the next slot after each disc has been loaded. The process is repeated until all six slots are full.

The audio system plays the last CD loaded and the display is updated. If some slots are already full and autoload is activated, the system will fill all empty slots.

### NOTE:

- o **This CD player is suitable only for 4.7 inch discs, do not use irregular shaped CDs.**
- o **The disc player holds up to six discs. Do not try to load more than six.**
- o **This six-disc CD player is equipped with a CD door. Compact discs should only be inserted into the player after the door has opened. Do not attempt to force the door open. Compact discs should only be loaded by pressing the LOAD control.**

## 3. DISC Select Button

- o Press ◀ (left arrow) to select the previous disc. (Play will begin on the first track of the disc unless shuffle mode is engaged.) Hold the button to continue reversing through the discs.
- o Press ▶ (right arrow) to select the next disc. Hold the button to fast-forward through the remaining discs.

## Display description

There are six CD slots in the audio system. When a disc is loaded into a particular slot (1-6), the number of a loaded slot is displayed by a circle to indicate the currently selected CD.

## 4. TRACK UP/DOWN

- o Press ▼ (down arrow) to revert to the previous track of the current disc. If the beginning of the disc is reached, the CD player seeks to the beginning of the last track on the current disc and begins playing.
- o Press ▲ (up arrow) to advance to the next track of the current disc. After the last track has been completed, the first track of the current disc will automatically replay.

## 5. SCAN /EQ Button

Press the SCAN button to hear a short sampling of all selections on the CD. (The CD scans in a forward direction, wrapping back to the first track at the end of the CD.) To stop on a particular selection, press the button again.

## EQ Button - Equalization Feature

The radio has five EQ modes: OFF, CLASSICAL, POP, ROCK, and JAZZ. Each press of the EQ button will advance to the next EQ setting. Radio and CD have independent EQ settings.

## 6. CD EJECT

- o Press the EJ button to stop and eject a CD. If a CD is ejected and not removed, the player will automatically reload the CD. This feature may be used when the ignition is ON or OFF.

## Auto eject

- o Press and momentarily hold the EJ button to engage auto eject. All CDs which are present in the player will be ejected one at a time. If a CD is ejected and not removed, the player will automatically reload the CD. This feature may be used when the ignition is ON or OFF.

## 7. FF/REV

- o Press and hold the FF button until the desired selection is reached. If the end of the disc is reached, the CD will return to the first track on the first disc. Release the button to disengage fast forward mode. When in fast forward mode, your audio system will automatically lower the volume level of the playing media.
- o Press and hold the REV button until the desired selection is reached. If the beginning of the disc is reached, the CD will begin play at the first track. Release the button to disengage reverse mode. When in reverse mode, your audio system will automatically lower the volume level of the playing media.

## 8. REPEAT(RPT)

When engaged, the repeat feature has three different modes: RPT Track, RPT DIR, RPT OFF.

RPT Track will continuously play the current track selected. RPT DIR will continuously play the current MP3 directory.

- o Press the RPT control until the desired repeat mode is displayed. The audio system will then engage the desired repeat mode.

## RANDOM(RND)

When engaged, the random feature has three different modes: Random Disc, Random Directory (MP3 only), and Random Off.

RANDOM DISC randomly plays tracks from the disc presently in the audio system. RANDOM DIRECTORY plays all the tracks on the current MP3 directory in random order.

- o Press the RND control until the desired shuffle mode is displayed. The audio system will then engage the desired random mode.

## 9. CHANGE DIRECTORY(DIR)

Press DIR control to change MP3 directories.

## 10. MP3 TEXT mode

Each press of the TEXT button will advance through the following MP3 track information:

- 1) Song Title
- 2) Artist Name
- 3) Album Name
- 4) Filename
- 5) Directory Name
- 6) Number of tracks on the current disc

Rotate the AUDIO-SEL knob to view additional characters.

## 11. Adjustment Mode Select Knob

Pressing the AUDIO SEL knob will initiate Audio Mode. Each subsequent press will select the next adjustment in the following order.

- 1) Bass adjust  
The bass adjust control allows you to increase or decrease the audio system's bass output. Rotate the AUDIO SEL knob to change the bass setting.
- 2) Midrange adjust  
The midrange adjust control allows you to increase or decrease the audio system's midrange output. Rotate the AUDIO SEL knob to change the midrange setting.
- 3) Treble adjust  
The treble adjust control allows you to increase or decrease the audio system's treble output. Rotate the AUDIO SEL knob to change the treble setting.
- 4) Speaker balance adjust  
Speaker sound distribution can be adjusted between the right and left speakers by rotating the AUDIO SEL knob.
- 5) Speaker fade adjust  
Speaker sound can be adjusted between the front and rear speakers by rotating the AUDIO SEL knob.

## NOTE:

- o To assure proper operation of the unit, keep the vehicle interior temperature within a normal range by using the vehicle's air conditioning or heating system.
- o When replacing the fuse, replace it with a fuse having the correct capacity.
- o This equipment is designed to be used only in a 12 volt DC battery system with negative ground.
- o This unit is made of precision parts. Do not attempt to disassemble or adjust any parts.
- o When driving your vehicle, be sure to keep the volume of the unit set low enough to allow you to hear sounds coming from the outside.
- o Do not expose this equipment (including the speakers) to water or excessive moisture.

**CAUTION:**

- o Do not insert warped or poor quality discs into the CD player as damage to the unit may occur.
- o Do not insert anything like coins into the player slot as damage to the unit may occur.
- o Do not place beverages close to the audio system. The playback mechanism may be damaged if you spill them.
- o Do not impact or strike the audio system, or the playback mechanism could be damaged.
- o Driving off-road or other vibrations may skip your compact disc. Do not use the audio system off-road as the discs could be scratched and damaged.
- o Do not grip or pull out the disc with your hand while the disc is being pulled into the unit by the self loading mechanism. These can cause disc scratching to occur or damage the compact disc player.
- o Avoid using CD-Recordable or CD Rewritable to ensure proper operation. When using the compact disc player, professionally recorded CDs are recommended.

**CARE OF DISCS**

B850A02F-AAT

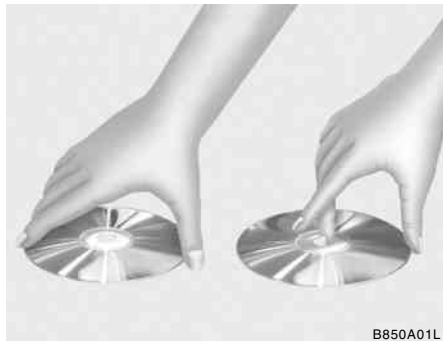
**Proper Handling**

B850A01L

Handle your disc as shown. Do not drop the disc. Hold the disc so you will not leave fingerprints on the surface. If the surface is scratched, it may cause the pickup to skip signal tracks. Do not affix tape, paper, or gummed labels on the disc. Do not write on the disc.

**Damaged Disc**

Do not attempt to play damaged, warped or cracked discs. These could severely damage the playback mechanism.

**Storage**

When not in use, place your discs in their individual case and store them in a cool place away from the sun, heat, and dust. Do not grip or pull out the disc with your hand while the disc is being pulled into the unit by the self loading mechanism.

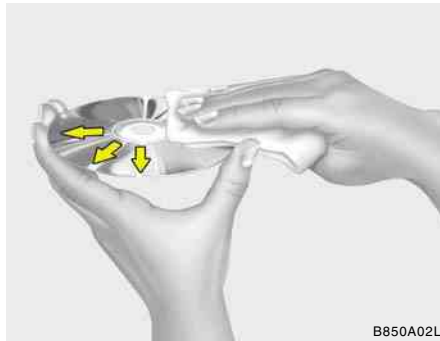
**Keep Your Discs Clean**

B850A02L

Fingerprints, dust, or soil on the surface of a disc could cause the pickup to skip signal tracks. Wipe the surface clean with a clean soft cloth. If the surface is heavily soiled, dampen a clean soft cloth in a solution of mild neutral detergent to wipe it clean. See drawing.

**ANTENNA**

B870D01Y-AAT

**Glass Antenna**

HNF2189

When the radio power switch is turned on while the ignition key is in either the "ON" or "ACC" position, your car will receive both AM and FM broadcast signals through the antenna in the rear window glass.

**CAUTION:**

- o Do not clean the inner side of the rear window glass with an abrasive type of glass cleaner or use a scraper to remove foreign deposits from the inner surface of the glass as this may cause damage to the antenna elements.
- o Avoid adding metallic coatings to the rear window glass, such as Ni, Cd, etc. These can disturb receiving AM and FM broadcast signals.



# DRIVING YOUR HYUNDAI

Engine Exhaust Can Be Dangerous! .....	2-2
Before Starting the Engine .....	2-3
Key Positions .....	2-3
Starting .....	2-4
Operating the Manual Transaxle .....	2-5
Automatic Transaxle .....	2-8
Power Adjustable Pedals .....	2-11
Anti-Lock Brake System (ABS) .....	2-12
Electronic Stability Control (ESC) System .....	2-13
Good Braking Practices .....	2-14
Driving for Economy .....	2-15
Smooth Cornering .....	2-16
Winter Driving .....	2-16
Trailer or Vehicle Towing .....	2-19
Vehicle Load Limit .....	2-22

**WARNING: ENGINE EXHAUST CAN BE DANGEROUS!**

C010A03A-AAT

Engine exhaust fumes can be extremely dangerous. If, at any time, you smell exhaust fumes inside the vehicle, open the windows immediately.

**o Do not inhale exhaust fumes.**

Exhaust fumes contain carbon monoxide, a colorless, odorless gas that can cause unconsciousness and death by asphyxiation.

**o Be sure the exhaust system does not leak.**

The exhaust system should be checked whenever the vehicle is raised to change the oil or for any other purpose. If you hear a change in the sound of the exhaust or if you drive over something that strikes the underneath side of the car, have the exhaust system checked as soon as possible by your Hyundai dealer.

**o Do not run the engine in an enclosed area.**

Letting the engine idle in your garage, even with the garage door open, is a hazardous practice. Never run the engine in your garage any longer than it takes to start the engine and back the car out.

**o Avoid idling the engine for prolonged periods with people inside the car.**

If it is necessary to idle the engine for a prolonged period with people inside the car, be sure to do so only in an open area with the air intake set at "Fresh" and fan operating at one of the higher speeds so fresh air is drawn into the interior.

If you must drive with the trunk lid open because you are carrying objects that make this necessary:

1. Close all windows.
2. Open side vents.
3. Set the air intake control at "Fresh", the air flow control at "Floor" or "Face" and the fan at one of the higher speeds.

To assure proper operation of the ventilation system, be sure the ventilation air intakes located just in front of the windshield are kept clear of snow, ice, leaves or other obstructions.

**PROPOSITION 65 WARNING:**

Engine exhaust and a wide variety of automobile components and parts, including components found in the interior furnishings in a vehicle, contain or emit chemicals known to the State of California to cause cancer and birth defects and reproductive harm. In addition, certain fluids contained in vehicles and certain products of component wear contain or emit chemicals known to the State of California to cause cancer and birth defects or other reproductive harm.

## BEFORE STARTING THE ENGINE

C020A01A-AAT

Before you start the engine, you should always:

1. Look around the vehicle to be sure there are no flat tires, puddles of oil, water or other indications of possible trouble.
2. After entering the car, check to be sure the parking brake is engaged.
3. Check that all windows and lights are clean.
4. Check that the interior and exterior mirrors are clean and in position.
5. Check your seat, seatback and headrest to be sure they are in their proper positions.
6. Lock all the doors.
7. Fasten your seat belt and be sure that all other occupants have fastened theirs.
8. Turn off all lights and accessories that are not needed.
9. When you turn the ignition switch to "ON", check that all appropriate warning lights are operating and that you have sufficient fuel.
10. Check the operation of warning lights and all bulbs when key is in the "ON" position.

## TO START THE ENGINE

C030A01E-AAT

### COMBINATION IGNITION SWITCH

- o If your Hyundai is equipped with a manual transaxle, place the shift lever in neutral and depress the clutch pedal fully.
- o If your Hyundai has an automatic transaxle, place the shift lever in "P" (park).
- o To start the engine, insert the ignition key and turn it to the "START" position. Release it as soon as the engine starts. Do not hold the key in the "START" position for more than 15 seconds.

#### NOTE:

- o **For safety, the engine will not start if the clutch pedal is not depressed fully (Manual Transaxle) or the shift lever is not in "P" or "N" Position (Automatic Transaxle).**
- o **The ignition key cannot be turned from "ACC" position to "LOCK" position unless the shift lever is in the "P" (Park) position or the negative battery terminal is disconnected from the battery. To remove the key, always confirm that the shift lever is securely positioned in "P" (Park) (For Automatic Transaxle).**
- o **For additional information about starting, see page 2-4.**

## KEY POSITIONS

C040A01A-AAT

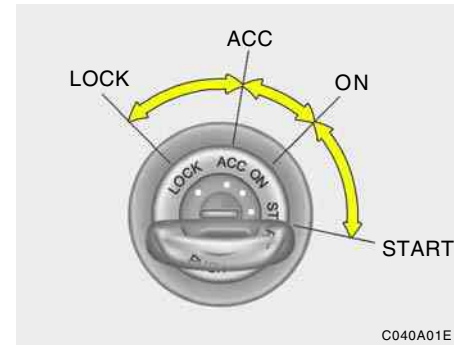

#### CAUTION:

The engine should not be turned off or the key removed from the ignition key cylinder while the car is in motion. The steering wheel is locked by removing the key.

#### o "START"

The engine is started in this position. It will crank until you release the key.

**NOTE:**

Do not hold the key in the "START" position for more than 15 seconds.

- o "ON"

When the key is in the "ON" position, the ignition is on and all accessories may be turned on. If the engine is not running, the key should not be left in the "ON" position. This will discharge the battery and may also damage the ignition system.

- o "ACC"

With the key in the "ACC" position, some electrical accessories (radio, etc.) may be operated.

- o "LOCK"

The key can be removed or inserted in this position.

To protect against theft, the steering wheel locks by removing the key.

**NOTE:**

To unlock the steering wheel, insert the key, and then turn the steering wheel and key simultaneously.

C070C01A-AAT

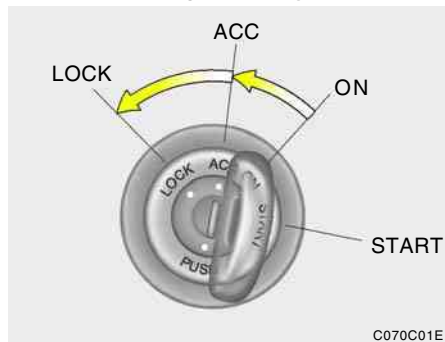
**To remove the ignition key**

C070C01E

1. Turn the ignition key to the "ACC" position.
2. Simultaneously push and turn the ignition key counterclockwise from the "ACC" position to the "LOCK" position.
3. The key can be removed in the "LOCK" position.

**STARTING**

C050A01A-AAT

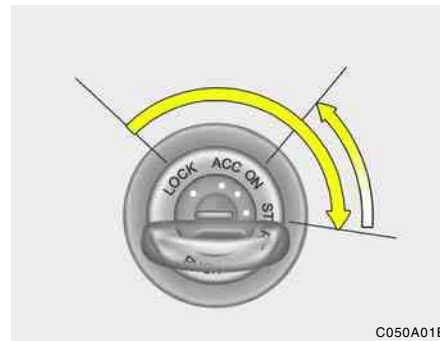

C050A01E

**WARNING:**

Never run the engine in a closed or poorly ventilated area any longer than is needed to move your car in or out of the area. The carbon monoxide gas emitted is odorless and can cause serious injury or death.

## OPERATING THE MANUAL TRANSAXLE (5 SPEED M/T)

C070A01NF-GAT



C070A01NF-A

This shift pattern is imprinted on the shift knob. The transaxle is fully synchronized in all forward gears so shifting to either a higher or a lower gear is easily accomplished.

C050B01A-AAT

### Normal Conditions:

The Starting Procedure:

1. Insert key, and fasten the seat belt.
2. Depress the clutch pedal fully and place the gearshift lever (manual transaxle) in neutral or the selector lever (automatic transaxle) in "P" (park) position.
3. After turning the ignition key to the "ON" position, make certain all warning lights and gauges are functioning properly before starting the engine.



### WARNING:

Be sure that the clutch is fully depressed when starting a manual transaxle vehicle. Your manual transaxle equipped vehicle will not start unless the clutch pedal is fully depressed. On a manual transaxle equipped vehicle that can be started without depressing the clutch, there is the potential to cause damage to the vehicle or injury to someone inside or outside the vehicle as a result of the forward or backward movement of the vehicle that will occur if the clutch is not depressed when the vehicle is started.

4. Turn the ignition key to the "START" position and release it when the engine starts. After the engine has started, allow the engine to run for 10 to 20 seconds prior to placing the vehicle in gear. The starter should not be operated for more than 15 seconds at a time. Wait 15-30 seconds between starting attempts to protect the starter from overheating.

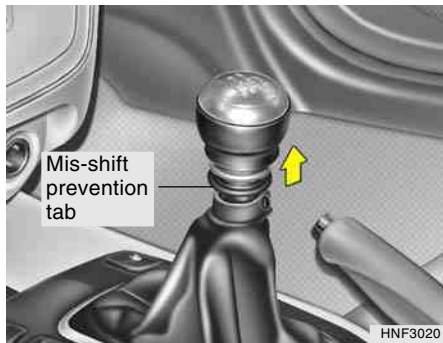

When shifting into reverse gear, pull the mis-shift prevention tab and shift into reverse gear position.

#### NOTE:

- o To shift into reverse, rest the lever in neutral for at least 3 seconds after your car is completely stopped. Then move the lever into the reverse position.
- o During cold weather, shifting may be difficult until the transaxle lubricant has warmed up. This is normal and not harmful to the transaxle.
- o If you've come to a complete stop and it's hard to shift into 1st or R(Reverse), put the shift lever in N(Neutral) position and release the clutch. Press the clutch pedal back down, and then shift into 1st or R(Reverse) gear position.

- o Do not use the shift lever as a handrest during driving, as this can result in premature wear of the transaxle shift forks.

**!** **WARNING:**  
Do not downshift more than 2 gears or downshift the gear when the engine is running at high speed (5,000 RPM or higher). Such a downshifting may damage the engine.

**!** **CAUTION:**  
When downshifting from fifth gear to fourth gear, caution should be taken not to inadvertently press the gear shift lever sideways in such a manner that second gear is engaged. Such a drastic downshift may cause the engine speed to increase to the point that the tachometer will enter the red-zone. Such over-revving of the engine may possibly cause engine damage.

C070B02A-AAT

#### Using the Clutch

The clutch should be pressed all the way to the floor before shifting, then released slowly. The clutch pedal should always be fully released while driving. Do not rest your foot on the clutch pedal while driving. This can cause unnecessary wear. Do not partially engage the clutch to hold the car on an incline. This causes unnecessary wear. Use the foot brake or parking brake to hold the car on an incline. Do not operate the clutch pedal rapidly and repeatedly.

C070E020-AAT

**RECOMMENDED SHIFT POINTS**

The shift points as shown on the chart are recommended for optimum fuel economy and performance.

Shift from-to	Recommended
1-2	15 mph (20 km/h)
2-3	25 mph (40 km/h)
3-4	35 mph (55 km/h)
4-5	45 mph (75 km/h)

C070D020-AAT

**Good Driving Practices**

- o Never take the car out of gear and coast down a hill. This is extremely hazardous. Always leave the car in gear.
- o Don't "ride" the brakes. This can cause them to overheat and malfunction. Instead, when you are driving down a long hill, slow down and shift to a lower gear. When you do this, engine braking will help slow the car.
- o Slow down before shifting to a lower gear. This will help avoid over-revving the engine, which can cause damage.
- o Slow down when you encounter cross winds. This gives you much better control of your car.
- o Be sure the car is completely stopped before you attempt to shift into reverse. The transaxle can be damaged if you do not. To shift into reverse, depress the clutch, move the shift lever to neutral, wait three seconds, then shift to the reverse position.
- o Exercise extreme caution when driving on a slippery surface. Be especially careful when braking, accelerating or shifting gears. On a slippery surface, an abrupt change in vehicle speed can cause the drive wheels to lose traction and the vehicle to go out of control.

**WARNING:**

- o **Avoid high cornering speeds.**
- o **Do not make quick steering wheel movements, such as sharp lane changes or fast, sharp turns.**
- o **Always wear your seat belts.**  
In a collision, an unbelted person is significantly more likely to die than a person wearing a seat belt.
- o **The risk of rollover is greatly increased if you lose control of your vehicle at highway speeds.**
- o **Loss of control often occurs if two or more wheels drop off the roadway and the driver oversteers to reenter the roadway.**
- o **In the event your vehicle leaves the roadway, do not steer sharply. Instead, slow down before pulling back into the travel lanes.**
- o **Never exceed posted speed limits.**

## AUTOMATIC TRANSAXLE (4 SPEED A/T, 5 SPEED A/T)

C090A01NF-GAT  
(If Installed)



The highly efficient Hyundai automatic transaxle has four/five forward speeds and one reverse speed. The individual speeds are selected automatically, depending on the position of the speed selector lever. The selector lever has 2 gates; the main gate and the manual gate.

### NOTE:

For information on manual gate operation, refer to "Sports Mode".

In the main gate, the selector lever has 4 positions.

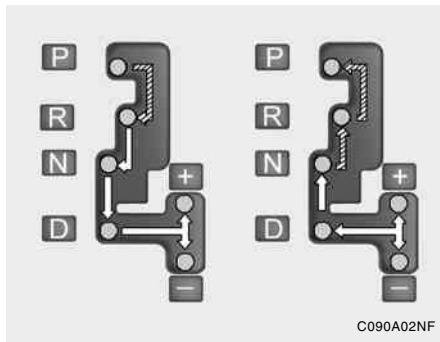

### NOTE:

➔ **Depress the brake pedal when shifting.**

➔ **The selector lever can be shifted freely.**

**The first few shifts on a new vehicle, or if the battery has been disconnected, may be somewhat abrupt. This is a normal condition, and the shifting sequence will adjust after shifts are cycled a few times by the T.C.M (Transaxle Control Module).**



**CAUTION:**  
Never shift into "R" or "P" position while the vehicle is moving.

The indicator lights in the instrument cluster indicate the selector lever position when the ignition is switched "ON". During sports mode operation, the gear currently in use displays in the numeral indicator.

C090B02A-AAT

**The function of each position is as follows:**

### o P (Park):

Use to hold the vehicle in place when parked or while starting the engine. Whenever parking the car, apply the parking brake and shift the selector lever to the "P" (Park) position.



**CAUTION:**  
Never place the selector lever in the "P" (Park) position unless the vehicle is fully stopped. Failure to observe this caution will cause severe damage to the transaxle.



C090C01A-AAT

**o R (Reverse):**

Use for backing up the vehicle. Bring the car to a complete stop before shifting the selector lever to "R" position.

C090D02A-AAT

**o N (Neutral):**

In the "N" position, the transaxle is in neutral, which means that no gears are engaged. The engine can be started with the shift lever in "N" position, although this is not recommended except if the engine stalls while the car is moving.

C090E01NF-GAT

**o D (Drive):**

Use for normal driving. The transaxle will automatically shift through a four/five gear sequence.

C090F02L-GAT

**Sports Mode**

Whether the vehicle is stationary or in motion, sports mode is selected by pushing the selector lever from the "D" position into the manual gate. To return to "D" range operation, push the selector lever back into the main gate.

In sports mode, moving the selector lever backwards and forwards can make rapid gearshifts simple. In contrast to a manual transaxle, the sports mode allows gearshifts with the accelerator pedal depressed.

**UP (+)** : Push the lever forward once to shift up one gear.

**DOWN (-)** : Pull the lever backwards once to shift down one gear.

**SKIP** : By rapidly moving the selector forward or backward twice, it is possible to skip one gear, i.e. 1st to 3rd or 3rd to 1st .

**CAUTION:**

- o In sports mode, the driver must execute upward shifts in accordance with prevailing road conditions, taking care to keep the engine speed below the red zone.
- o For engine protection, upward shifts are made automatically when the engine rpm reaches the red zone.
- o By rapidly moving the selector lever backwards (-) twice it is possible to skip one gear, i.e., 3rd to 1st, 4th to 2nd or 5th to 3rd. Since sudden engine braking and/or rapid acceleration can cause a loss of traction, however, downshifts must be made carefully in accordance with the vehicle's speed.

**NOTE:**

- o In sports mode, only the four/five forward gears can be selected. To reverse or park the vehicle, move the selector lever to the "R" or "P" position as required.
- o In sports mode, downward shifts are made automatically when the vehicle slows down. When the vehicle stops, 1st gear is automatically selected.

- o To maintain the required levels of vehicle performance and safety, the system may not execute certain gearshifts when the selector lever is operated.
- o Before driving away from a stop on a slippery road, push the selector lever forward into the +(UP) position. This causes the transaxle to shift into 2nd gear which is better for smooth driving away on a slippery road. Push the selector lever to the -(DOWN) side to shift back to 1st gear.

C090H01L-GAT

**NOTE:**

- o For smooth and safe operation, depress the brake pedal when shifting from "Neutral" position or "Park" position to a forward or reverse gear.
- o The ignition key must be in the "ON" position and the brake pedal fully depressed in order to move the shift lever from the "P" (Park) position to any of the other positions.
- o It is always possible to shift from "R", "N", or "D" position to "P" position. The vehicle must be fully stopped to avoid transaxle damage.

C090I03L-GAT

**CAUTION:**

- o Shift into "R" and "P" position only when the vehicle has completely stopped.
- o Do not accelerate the engine in reverse or any of the forward positions with the brakes applied.
- o Always apply the footbrake when shifting from "P" or "N", to "R" or "D" position.
- o Do not use the "P" (Park) position in place of the parking brake. Always set the parking brake, shift the transaxle into "P" (Park) position and turn off the ignition when you leave the vehicle, even momentarily. Never leave the vehicle unattended while the engine is running.
- o When accelerating from a stop on a steep hill, the vehicle may have a tendency to roll backwards. Shifting the shift lever into 2nd gear while in Sport mode will help prevent the vehicle from rolling backwards.
- o Check the automatic transaxle fluid level regularly, and add fluid as necessary.
- o See the maintenance schedule for the proper fluid recommendation.

C090J01NF-GAT

**SHIFT LOCK RELEASE (If Installed)**

If you cannot move the shift lever from the "P" (Park) position to any other position with the brake pedal fully depressed and the ignition key in the "ON" position, remove the cap on the console and with a thin object such as a flat-head screwdriver, push the shift lock release button down. Then, with the brake pedal depressed, move the shift lever to the desired position, and then the shift lock release button will automatically return to its original position after shifting from the "P" (Park) position. Then, reinstall the cap.

If you need to use the shift lock release, it could mean your car is developing a problem. Have the car checked by your Hyundai dealer.

## POWER ADJUSTABLE PEDALS

C090N030-AAT

**Good Driving Practices**

- o Never move the gear selector lever from "P" or "N" to any other position with the accelerator pedal depressed.
- o Never move the gear selector lever into "P" when the vehicle is in motion.
- o Be sure the car is completely stopped before you attempt to shift into "R".
- o Never take the car out of gear and coast down a hill. This may be extremely hazardous. Always leave the car in gear when moving.
- o Do not "ride" the brakes. This can cause them to overheat and malfunction. Instead, when you are driving down a long hill, slow down and shift to a lower gear. When you do this, engine braking will help slow the car.
- o Slow down before shifting to a lower gear. Otherwise, the lower gear may not be engaged.
- o Always use the parking brake. Do not depend on placing the transaxle in "P" to keep the car from moving.
- o Exercise extreme caution when driving on a slippery surface. Be especially careful when braking, accelerating or shifting gears. On a slippery surface, an abrupt change in vehicle speed can cause the drive wheels to lose traction and the vehicle to go out of control.

**WARNING:**

- o **Avoid high cornering speeds.**
- o **Do not make quick steering wheel movements, such as sharp lane changes or fast, sharp turns.**
- o **Always wear your seat belts.**  
In a collision, an unbelted person is significantly more likely to die than a person wearing a seat belt.
- o **The risk of rollover is greatly increased if you lose control of your vehicle at highway speeds.**
- o **Loss of control often occurs if two or more wheels drop off the roadway and the driver oversteers to reenter the roadway.**
- o **In the event your vehicle leaves the roadway, do not steer sharply. Instead, slow down before pulling back into the travel lanes.**
- o **Never exceed posted speed limits.**
- o **Excessive depressing of the accelerator pedal in slippery driving conditions such as pulling out of deep snow or mud may cause severe damage to the transaxle. Rocking the vehicle is not recommended. Rather, use an appropriate towing method.**

C100A01NF-AAT

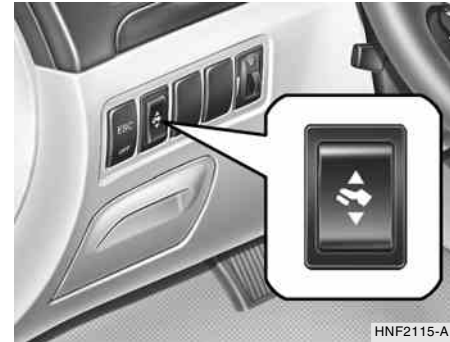
**(With Automatic Transaxle) (If Installed)**

To adjust the position of the accelerator and brake pedals, turn the ignition key to the "ON" position with the selector lever in the "P" position and push the switch.

If you push the "▲" portion of the switch, the pedals move rearward.  
If you push the "▼" portion of the switch, the pedals move forward.

## ANTI-LOCK BRAKE SYSTEM (ABS)

C120A03A-AAT

**(If Installed)**

The Anti-Lock Brake System (ABS) is designed to prevent wheel lock-up during sudden braking or on hazardous road surfaces. The ABS control module monitors the wheel speed and controls the pressure applied to each brake. Thus, in emergency situations or on slick roads, ABS will increase vehicle control during braking.

**NOTE:**

During ABS (ESC) operation, a pulsation may be felt in the brake pedal when the brakes are applied. Also, a noise may be heard in the engine compartment while braking. These conditions are normal and indicate that the anti-lock brake system (Electronic Stability Control System) is functioning properly.

**Setting the driver's position**

- 1) Be sure the parking brake is engaged.
- 2) Move the accelerator and brake pedals to the front most position by pushing the "▼" portion of the switch.
- 3) Adjust the seat position and the steering wheel angle properly.
- 4) Move the pedals toward you until you can fully depress the brake pedal by pushing the "▲" portion of the switch.
- 5) Depress the pedals a few times to get used to the feel after adjusting.

**WARNING:**

- o Adjust the pedals after parking the vehicle on level ground. Never attempt to adjust the pedals while the vehicle is moving.
- o Never adjust the pedals with your foot on the accelerator pedal as this may result in increasing the engine speed and acceleration.
- o Make sure that you can fully depress the brake pedal before driving. Otherwise, you may not be able to hold down the brake pedal firmly in an emergency stop.

**WARNING:**

ABS (ESC) will not prevent accidents due to improper or dangerous driving maneuvers. Even though vehicle control is improved during emergency braking, always maintain a safe distance between you and objects ahead. Vehicle speeds should always be reduced during extreme road conditions.

The braking distance for cars equipped with an anti-lock braking system (ESC) may be longer than for those without it in the following road conditions.

During these conditions the vehicle should be driven at reduced speeds:

- o Rough, gravel or snow-covered roads.
- o With tire chains installed.
- o On roads where the road surface is pitted or has different surface height.

The safety features of an ABS (ESC) equipped vehicle should not be tested by high speed driving or cornering. This could endanger the safety of yourself or others.

## ELECTRONIC STABILITY CONTROL (ESC) SYSTEM

C310A01NF-AAT  
(If Installed)



The Electronic Stability Control (ESC) system is designed to stabilize the vehicle during cornering maneuvers. ESC checks where you are steering and where the vehicle is actually going. ESC applies the brakes at individual wheels and intervenes in the engine management system to stabilize the vehicle.

The Electronic Stability Control (ESC) system is an electronic system designed to help the driver maintain vehicle control under adverse conditions. It is not a substitute for safe driving practices. Factors including speed, road conditions and driver steering input can all affect whether ESC will be effective in preventing a

loss of control. It is still your responsibility to drive and corner at reasonable speeds and to leave a sufficient margin of safety.



### CAUTION:

**Driving with varying tire or wheel sizes may cause the ESC system to malfunction. When replacing tires, make sure they are the same size as your original tires.**



### WARNING:

**Electronic stability control is only a driving aid; all normal precautions for driving in inclement weather and on slippery road surfaces should be observed.**

C310B01NF-AAT

### ESC ON/OFF Mode

When the ESC is operating, the ESC indicator in the instrument cluster will blink.

If you turn the system off by pressing the ESC switch, the ESC-OFF indicator will come on and stay on. In the ESC-OFF mode, the stability control will be deactivated. Adjust your driving accordingly. To turn the system back on, press the switch again. The ESC-OFF indicator should go off.

### NOTE:

**The ESC mode will automatically be turned ON after the engine is turned off and restarted.**

## GOOD BRAKING PRACTICES

C310D01NF-AAT

**Indicators and Warning**

The indicators should illuminate when the ignition key is turned to ON or START but should go out after three seconds.

If the indicators do not illuminate, or the ESC or ESC-OFF indicator does not go out after 3 seconds, have the vehicle checked by an authorized dealer.

Should there be any unusual operation of the device while driving, the ESC-OFF indicator illuminates as a warning.

If the ESC-OFF indicator illuminates, drive your car to a safe place and stop the engine. Then, start the engine again to check if the ESC-OFF indicator goes out.

If the indicator remains lit even after the engine has been started, have your car checked by an authorized Hyundai dealer.

C130A01A-AAT

**WARNING:**

**Nothing should be carried on top of the shelf panel behind the rear seat. If there were an accident or a sudden stop, such objects could move forward and cause damage to the vehicle or injure the occupants.**

- o After being parked, check to be sure the parking brake is not engaged and that the parking brake indicator light is out before driving away.
- o Driving through water may get the brakes wet. They can also get wet when the car is washed. Wet brakes can be dangerous! Your car will not stop as quickly if the brakes are wet. Wet brakes may cause the car to pull to one side. To dry the brakes, apply the brakes lightly until the braking action returns to normal, taking care to keep the car under control at all times. If the braking action does not return to normal, stop as soon as it is safe to do so and call your Hyundai dealer for assistance.
- o Don't coast down hills with the car out of gear. This is extremely hazardous. Keep the car in gear at all times, use the brakes to slow down, then shift to a lower gear so that engine braking will help you maintain a safe speed.
- o Don't "ride" the brake pedal. Resting your foot on the brake pedal while driving can be dangerous because it can result in the brakes overheating and losing their effectiveness. It also increases the wear of the brake components.
- o If a tire goes flat while you are driving, apply the brakes gently and keep the car pointed straight ahead while you slow down. When you are moving slowly enough for it to be safe to do so, pull off the road and stop in a safe place.
- o If your car is equipped with an automatic transaxle, don't let your car creep forward. To avoid creeping forward, keep your foot firmly on the brake pedal when the car is stopped.
- o Use caution when parking on a hill. Engage the parking brake and place the gear selector lever in "P" (automatic transaxle) or in first or reverse gear (manual transaxle). If your car is facing downhill, turn the front wheels into the curb to help keep the car from rolling. If your car is facing uphill, turn the front wheels away from the curb to help keep the car from rolling. If there is no curb or if it is required by other conditions to keep the car from rolling, block the wheels.

## DRIVING FOR ECONOMY

C140A01A-AAT

You can save fuel and get more miles from your car if you follow these suggestions:

- o Under some conditions your parking brake can freeze in the engaged position. This is most likely to happen when there is an accumulation of snow or ice around or near the rear brakes or if the brakes are wet. If there is a risk that the parking brake may freeze, apply it only temporarily while you put the gear selector lever in "P" (automatic) or in first or reverse gear (manual transaxle) and block the rear wheels so the car cannot roll. Then release the parking brake.
- o Do not hold the vehicle on the upgrade with the accelerator pedal. This can cause the transaxle to overheat. Always use the brake pedal or parking brake.
- o Drive smoothly. Accelerate at a moderate rate. Don't make "jack-rabbit" starts or full-throttle shifts and maintain a steady cruising speed. Don't race between stoplights. Try to adjust your speed to that of the other traffic so you don't have to change speeds unnecessarily. Avoid heavy traffic whenever possible. Always maintain a safe distance from other vehicles so you can avoid unnecessary braking. This also reduces brake wear.
- o Drive at a moderate speed. The faster you drive, the more fuel your car uses. Driving at a moderate speed, especially on the highway, is one of the most effective ways to reduce fuel consumption.
- o Don't "ride" the brake or clutch pedal. This can increase fuel consumption and also increase wear on these components. In addition, driving with your foot resting on the brake pedal may cause the brakes to overheat, which reduces their effectiveness and may lead to more serious consequences.
- o Take care of your tires. Keep them inflated to the recommended pressure. Incorrect inflation, either too much or too little, results in unnecessary tire wear. Check the tire pressures at least once a month.
- o Be sure that the wheels are aligned correctly. Improper alignment can result from hitting curbs or driving too fast over irregular surfaces. Poor alignment causes faster tire wear and may also result in other problems as well as greater fuel consumption.
- o Keep your car in good condition. For better fuel economy and reduced maintenance costs, maintain your car in accordance with the maintenance schedule in Section 5. If you drive your car in severe conditions, more frequent maintenance is required (see Section 5 for details).
- o Keep your car clean. For maximum service, your Hyundai should be kept clean and free of corrosive materials. It is especially important that mud, dirt, ice, etc. not be allowed to accumulate on the underside of the car. This extra weight can result in increased fuel consumption and also contribute to corrosion.
- o Travel lightly. Don't carry unnecessary weight in your car. Weight reduces fuel economy.
- o Don't let the engine idle longer than necessary. If you are waiting (and not in traffic), turn off your engine and restart only when you're ready to go.

- o Remember, your Hyundai does not require extended warm-up. As soon as the engine is running smoothly, you can drive away. In very cold weather, however, give your engine a slightly longer warm-up period.
- o Don't "lug" or "over-rev" the engine. Lugging is driving too slowly in too high a gear resulting in the engine bucking. If this happens, shift to a lower gear. Over-revving is racing the engine beyond its safe limit. This can be avoided by shifting at the recommended speeds.
- o Use your air conditioning sparingly. The air conditioning system is operated by engine power so your fuel economy is reduced when you use it.

## SMOOTH CORNERING

C150A01A-AAT

Avoid braking or gear changing in corners, especially when roads are wet. Ideally, corners should always be taken under gentle acceleration. If you follow these suggestions, tire wear will be held to a minimum.

## WINTER DRIVING

C160A01A-AAT

The more severe weather conditions of winter result in greater wear and other problems. To minimize the problems of winter driving, you should follow these suggestions:

C160B01A-AAT

### Snowy or Icy Conditions

To drive your vehicle in deep snow, it may be necessary to use snow tires or to install tire chains on your tires. If snow tires are needed, it is necessary to select tires equivalent in size and type of the original equipment tires. Failure to do so may adversely affect the safety and handling of your car. Furthermore, speeding, rapid acceleration, sudden brake applications, and sharp turns are potentially very hazardous practices.

During deceleration, use engine braking to the fullest extent. Sudden brake applications on snowy or icy roads may cause skids to occur. You need to keep sufficient distance between the vehicle in operation in front and your vehicle. Also, apply the brake gently. It should be noted that installing tire chains on the tire will provide a greater driving force, but will not prevent side skids.

### NOTE:

**Tire chains are not legal in all states. Check state laws before fitting tire chains.**



C160C01A-AAT

### **Use High Quality Ethylene Glycol Coolant**

Your Hyundai is delivered with high quality ethylene glycol coolant in the cooling system. It is the only type of coolant that should be used because it helps prevent corrosion in the cooling system, lubricates the water pump and prevents freezing. Be sure to replace or replenish your coolant in accordance with the maintenance schedule in Section 5. Before winter, have your coolant tested to assure that its freezing point is sufficient for the temperatures anticipated during the winter.

C160D01A-AAT

### **Check Battery and Cables**

Winter puts additional burdens on the battery system. Visually inspect the battery and cables as described in Section 6. The level of charge in your battery can be checked by your Hyundai dealer or a service station.

C160E01A-AAT

### **Change to "Winter Weight" Oil if Necessary**

In some climates it is recommended that a lower viscosity "winter weight" oil be used during cold weather. See Section 9 for recommendations. If you aren't sure what weight oil you should use, consult your Hyundai dealer.

C160F01A-AAT

### **Check Spark Plugs and Ignition System**

Inspect your spark plugs as described in Section 6 and replace them if necessary. Also check all ignition wiring and components to be sure they are not cracked, worn or damaged in any way.

C160G01A-AAT

### **To Keep Locks from Freezing**

To keep the locks from freezing, squirt an approved de-icer fluid or glycerine into the key opening. If a lock is covered with ice, squirt it with an approved de-icing fluid to remove the ice. If the lock is frozen internally, you may be able to thaw it out by using a heated key. Handle the heated key with care to avoid injury.

C160H02A-AAT

### **Use Approved Window Washer Anti-Freeze in System**

To keep the water in the window washer system from freezing, add an approved window washer anti-freeze solution in accordance with instructions on the container. Window washer anti-freeze is available from Hyundai dealers and most auto parts outlets. Do not use engine coolant or other types of anti-freeze as these may damage the paint finish.

C160I01L-AAT

### Don't Let Your Parking Brake Freeze

Under some conditions your parking brake can freeze in the engaged position. This is most likely to happen when there is an accumulation of snow or ice around or near the rear brakes or if the brakes are wet. If there is a risk the parking brake may freeze, apply it only temporarily while you put the gear selector lever in "P" and block the rear wheels so the car cannot roll. Then release the parking brake.

C160J01A-AAT

### Don't Let Ice and Snow Accumulate Underneath

Under some conditions, snow and ice can build up under the fenders and interfere with the steering. When driving in severe winter conditions where this may happen, you should periodically check underneath the car to be sure the movement of the front wheels and the steering components is not obstructed.

C160K01A-AAT

### Carry Emergency Equipment

Depending on the severity of the weather where you drive your car, you should carry appropriate emergency equipment. Some of the items you may want to carry include tire chains, tow straps or chains, flashlight, emergency flares, sand, a shovel, jumper cables, a window scraper, gloves, ground cloth, coveralls, a blanket, etc.

## HIGHER SPEED MOTORING

C170A01A-AAT

### Pre-Trip Inspections

#### 1. Tires:

Adjust the tire inflation pressures to specification. Low tire inflation pressures will result in overheating and possible failure of the tires. Avoid using worn or damaged tires which may result in reduced traction or tire failure.

#### **NOTE:**

**Never exceed the maximum tire inflation pressure shown on the tires.**

#### 2. Fuel, engine coolant and engine oil:

High speed travel consumes more fuel than urban motoring. Do not forget to check both engine coolant and engine oil.

#### 3. Drive belt:

A loose or damaged drive belt may result in overheating of the engine.

## USE OF LIGHTS

C180A01A-AAT

Check your lights regularly for correct operation and always keep them clean. When driving during the day in conditions of poor visibility, it is helpful to drive with headlights on low beam. This enables you to be seen as well as to see.

## TRAILER OR VEHICLE TOWING

C190A01S-AAT

If you are considering towing with your car, you should first check with your State's Department of Motor Vehicles to determine their legal requirements.

Since laws vary from State to State the requirements for towing trailers, cars, or other types of vehicles or apparatus may differ. Ask your Hyundai dealer for further details before towing.



### CAUTION:

**Do not do any towing with your car during its first 1,200 miles (2,000 km) in order to allow the engine to properly break in. Failure to heed this caution may result in serious engine or transaxle damage.**

C190B01S-AAT

### Trailer Hitches

Select the proper hitch and ball combination, making sure that its location is compatible with that of the trailer or vehicle being towed.

Use a quality non-equalizing hitch which distributes the tongue load uniformly throughout the chassis.

The hitch should be bolted securely to the car and installed by a qualified technician. **DO NOT USE A HITCH DESIGNED FOR TEMPORARY INSTALLATION AND NEVER USE ONE THAT ATTACHES ONLY TO THE BUMPER.**

C190C01Y-AAT

### Trailer Brakes

If your trailer is equipped with a braking system, make sure it conforms to federal and/or local regulations and that it is properly installed and operating correctly.

### NOTE:

**If you tow a trailer or vehicle, your car will require more frequent maintenance due to the additional load. See Maintenance Under Severe Usage Conditions" on page 5-6.**

**CAUTION:**

- o Never connect a trailer brake system directly to the vehicle brake system.
- o When towing a trailer on steep grades (in excess of 12%) pay close attention to the engine coolant temperature gauge to ensure the engine does not overheat. If the needle of the coolant temperature gauge moves across the dial towards "H" (HOT), pull over and stop as soon as it is safe to do so, and allow the engine to idle until it cools down. You may proceed once the engine has cooled sufficiently.

C190D01S-AAT

**Safety Chains**

Should the hitch connection between your car and the trailer or vehicle you are towing fail, the trailer or vehicle could wander dangerously across other lanes of traffic and ultimately leave the roadway. To eliminate this potentially dangerous situation, safety chains, attached between your car and the trailer or towed vehicle, are required in most states.

C190E01NF-AAT

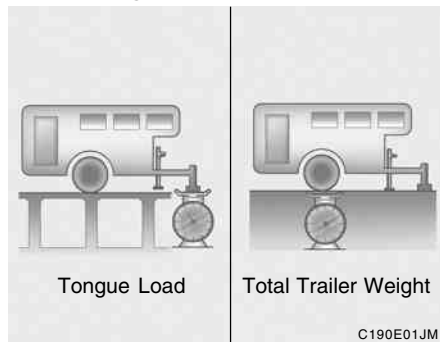
**Trailer Weight Limit**

- o Keep the tongue load 10% of the total trailer load.
- o Tongue load \_\_\_\_\_ x 100 = 10% (MAX)  
Total trailer weight
- o Tongue loads can be increased or decreased by re-distributing the load in the trailer.  
This can be verified by checking the total weight of the loaded trailer and then checking the load on the tongue.

**NOTE:**

1. Never load the trailer with more weight in the back than in the front. About 60% of the trailer load should be in the front half of the trailer and the remaining 40% in the rear.

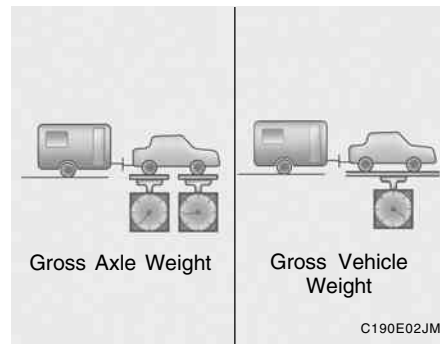

2. The total gross vehicle weight with trailer must not exceed the Gross Vehicle Weight Rating (GVWR) shown on the vehicle identification plate (see page 8-2). The total gross vehicle weight is the combined weight of the vehicle, driver, all passengers and their luggage, cargo, hitch, trailer tongue load and other optional equipment.

3. The front or rear axle weight must not exceed the Gross Axle Weight Rating (GAWR) shown on the vehicle identification plate (see page 8-2). It is possible that your towing package does not exceed the GVWR but exceeds the GAWR. Improper trailer loading and/or too much luggage in the trunk can overload the rear axle. Redistribute the load and check the axle weight again.

**CAUTION:**

The following specifications are recommended when towing a trailer. The loaded trailer weight cannot safely exceed the values in the chart below.

lbs(kg)

		Maximum Towable Weight	
		Trailer	Tongue
With Brake	3.3L	2000 (900)	200 (90)
	2.4L	1500 (675)	
Without Brake		1000 (450)	-

**WARNING:**

- o Improperly loading your vehicle and trailer can seriously affect its steering and braking performance causing a crash which could cause serious injury or death.
- o Towing a trailer affects vehicle handling and braking.
- o Drive more slowly when towing a trailer and allow more distance when braking.
- o Be careful when driving in slippery and windy conditions.
- o Be careful when turning and while driving up and down hills.

C190F01Y-GAT

**Trailer or Vehicle Towing Tips**

1. Before towing, check hitch and safety chain connections as well as proper operation of the trailer running lights, brake lights, and turn signals.
2. Always drive your vehicle at a moderate speed. (Less than 60 mph)
3. Trailer towing requires more fuel than normal conditions.
4. To maintain engine braking efficiency and electrical charging performance, do not tow a trailer with the transaxle in fifth gear (manual transaxle).
5. Always secure items in the trailer to prevent load shift while driving.
6. Check the condition and air pressure of all tires on the trailer and your car. Low tire pressure can seriously affect the handling. Also check the spare tire.
7. The vehicle/trailer combination is more affected by crosswind and buffeting. When being passed by a large vehicle, keep a constant speed and steer straight ahead. If there is too much wind buffeting, slow down to get out of the other vehicle's air turbulence.

8. When parking your car and trailer, especially on a hill, be sure to follow all the normal precautions. Turn your front wheel into the curb, set the parking brake firmly, and put the transaxle in 1st or Reverse (manual) or Park (automatic). In addition, place wheel chocks at each of the trailer's tires.
9. If the trailer has electric brakes, start your vehicle and trailer moving, and then apply the trailer brake controller by hand to be sure the brakes are working. This lets you check your electrical connection at the same time.
10. During your trip, check occasionally to be sure that the load is secure, and that the lights and any trailer brakes are still working.
11. Avoid jerky starts, sudden acceleration or sudden stops.
12. Avoid sharp turns and rapid lane changes.
13. Avoid holding the brake pedal down too long or too frequently. This could cause the brakes to overheat, resulting in reduced braking efficiency.
14. When going down a hill, shift into a lower gear and use the engine braking effect. When ascending a long grade, downshift the transaxle to a lower gear and reduce speed to reduce chances of engine overloading and/or overheating.

15. If you have to stop while going uphill, do not hold the vehicle in place by pressing on the accelerator. This can cause the automatic transaxle to overheat. Use the parking brake or footbrake.

**NOTE:**

**When towing check transaxle fluid more frequently.**

**CAUTION:**

**If overheating should occur when towing, (the temperature gauge reads near red zone), taking the following action may reduce or eliminate the problem.**

1. Turn off the air conditioner.
2. Reduce highway speed.
3. Select a lower gear when going uphill.
4. While in stop and go traffic, place the gear selector in park or neutral and idle the engine at a higher speed.

**VEHICLE LOAD LIMIT**

C190F01JM-AAT

**Tire and Loading Information Label**

TIRE AND LOADING INFORMATION			
SEATING CAPACITY		TOTAL 5	FRONT 2 REAR 3
The combined weight of occupants and cargo should never exceed 390 kg or 860 lbs.			
TIRE	SIZE	COLD TIRE PRESSURE	SEE OWNER'S MANUAL FOR ADDITIONAL INFORMATION
FRONT	P215 / 60R16	210KPA, 30PSI	
REAR	P215 / 60R16	210KPA, 30PSI	
SPARE	T125 / 80D16	420KPA, 60PSI	

I030A03NF-A

TIRE AND LOADING INFORMATION			
SEATING CAPACITY		TOTAL 5	FRONT 2 REAR 3
The combined weight of occupants and cargo should never exceed 390 kg or 860 lbs.			
TIRE	SIZE	COLD TIRE PRESSURE	SEE OWNER'S MANUAL FOR ADDITIONAL INFORMATION
FRONT	P225 / 50R17	210KPA, 30PSI	
REAR	P225 / 50R17	210KPA, 30PSI	
SPARE	T125 / 80D16	420KPA, 60PSI	

I030A04NF-A

The tire label located on the driver's side of the center pillar outer panel gives the original tire size, cold tire pressures recommended for your ve-

hicle, the number of people that can be in your vehicle and vehicle capacity weight.

### Steps for Determining Correct Load Limit

- (1) Locate the statement "The combined weight of occupants and cargo should never exceed XXX pounds" on your vehicle's placard.
- (2) Determine the combined weight of the driver and passengers that will be riding in your vehicle.
- (3) Subtract the combined weight of the driver and passengers from XXX kilograms or XXX pounds.
- (4) The resulting figure equals the available amount of cargo and luggage load capacity. For example, if the "XXX" amount equals 1400 lbs, and there will be five 150 lb. passengers in your vehicle, the amount of available cargo and luggage load capacity is 650 lbs. ( $1400 - 750 (5 \times 150) = 650$  lbs.)
- (5) Determine the combined weight of luggage and cargo being loaded on the vehicle. That weight may not safely exceed the available cargo and luggage load capacity calculated in Step 4.
- (6) If your vehicle will be towing a trailer, load from your trailer will be transferred to your vehicle. Consult this manual to determine how this reduces the available cargo and luggage load capacity of your vehicle.

### Example 1

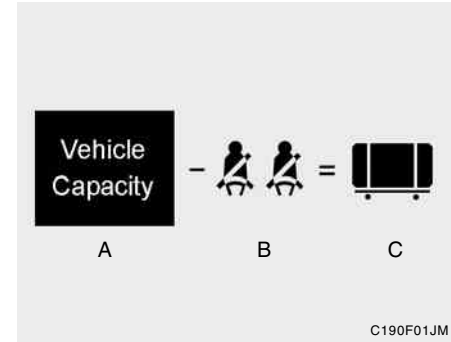

Item	Description	Total
A	Vehicle Capacity Weight	1400 lbs (635 kg)
B	Subtract Occupant Weight 150 lbs (68 kg) × 2	300 lbs (136 kg)
C	Available Cargo and Luggage Weight	1100 lbs (489 kg)

**Example 2**

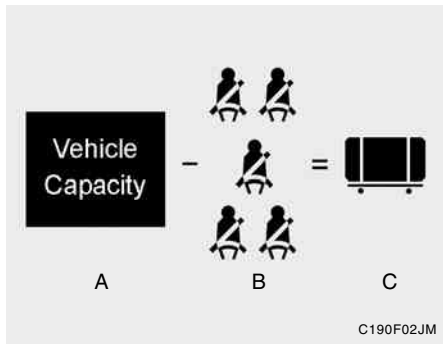

Item	Description	Total
A	Vehicle Capacity Weight	1400 lbs (635 kg)
B	Subtract Occupant Weight 150 lbs (68 kg) x 5	750 lbs (340 kg)
C	Available Cargo and Luggage Weight	650 lbs (295 kg)

**Example 3**

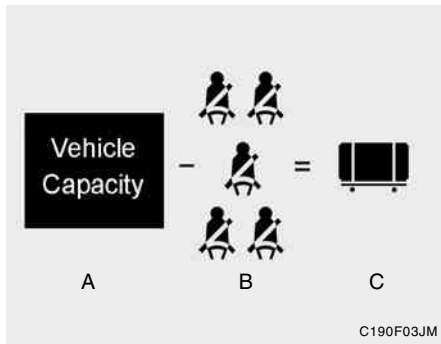

Item	Description	Total
A	Vehicle Capacity Weight	1400 lbs (635 kg)
B	Subtract Occupant Weight 172 lbs (78 kg) x 5	860 lbs (390 kg)
C	Available Cargo Weight	540 lbs (245 kg)

Refer to your vehicle's tire and loading information label for specific information about your vehicle's capacity weight and seating positions. The combined weight of the driver, passengers and cargo should never exceed your vehicle's capacity weight.



C190G02JM-AAT

**Compliance Label**

[ ]			
	GVWR	PAINT	TRIM
	TIRES	RIMS	COLD TIRE INFL
FRONT			
REAR			
THIS VEHICLE CONFORMS TO ALL APPLICABLE U. S. A. FEDERAL MOTOR VEHICLE SAFETY AND THEFT PREVENTION STANDARDS IN EFFECT ON THE DATE OF MANUFACTURE SHOWN ABOVE			
V. I. N. [ ]		TYPE: MPV	
[ ]			

C190G01JM

The compliance label is located on the driver's side of the center pillar outer panel.

The label shows the size of your original tires and the inflation pressures needed to obtain the gross weight capacity of your vehicle. This is called the GVWR (Gross Vehicle Weight Rating). The GVWR includes the weight of the vehicle, all occupants, fuel and cargo.

This label also tells you the maximum weights that can be supported by the front and rear axles, called Gross Axle Weight Rating (GAWR). To find out the actual loads on your front and rear axles, you need to go to a weigh station and weigh your vehicle. Your dealer can help you with this. Be sure to spread out your load equally on the left and right sides of the centerline.

**WARNING:**

- o Never exceed the GVWR for your vehicle or the GAWR for either the front or rear axle.
- o Do not load your vehicle any heavier than the GVWR or either the maximum front or rear GAWR. If you do, parts on your vehicle can break, and it can change the way your vehicle handles. This could cause you to lose control and crash. Also, overloading can shorten the life of your vehicle.

**WARNING:**

- o Overloading your vehicle can cause heat buildup in your vehicle's tires and possible tire failure that could lead to a crash.
- o Overloading your vehicle can cause increased stopping distances that could lead to a crash.
- o A crash resulting from poor handling vehicle damage, tire failure, or increased stopping distances could result in serious injury or death.

**NOTE:**

- o **Overloading your vehicle may cause damage. Repairs would not be covered by your warranty. Do not overload your vehicle.**
- o **Using heavier suspension components to get added durability might not change your weight ratings. Ask your dealer to help you load your vehicle the right way.**

The label will help you decide how much cargo and installed equipment your vehicle can carry.

If you carry items inside your vehicle – like suitcases, tools, packages, or anything else – they move as fast as the vehicle goes. If you have to stop or turn quickly, or if there is a crash, the items will keep going and can cause an injury if they strike the driver or a passenger.

**WARNING:**

**Items you carry inside your vehicle can strike and injure people in a sudden stop or turn, or in a crash.**

- o **Put things in the cargo area of your vehicle. Try to spread the weight evenly.**
- o **Never stack items, like suitcases, inside the vehicle above the tops of the seats.**
- o **Do not leave an unsecured child restraint in your vehicle.**
- o **When you carry something inside the vehicle, secure it.**
- o **Do not drive with a seat folded down unless necessary.**

## WHAT TO DO IN AN EMERGENCY

If the Engine Will Not Start .....	3-2
Jump Starting .....	3-3
If the Engine Overheats .....	3-4
Spare Tire .....	3-5
If You Have a Flat Tire .....	3-6
Changing a Flat Tire .....	3-6
If Your Vehicle Must Be Towed .....	3-11
Emergency Towing .....	3-13
If You Lose Your Keys .....	3-13

# 3

### IF THE ENGINE WILL NOT START

D010A01A-AAT



#### **WARNING:**

If the engine will not start, do not push or pull the car to start it. This could result in a collision or cause other damage. In addition, push or pull starting may cause the catalytic converter to be overloaded and create a fire hazard.

D010B02A-AAT

#### **If Engine Doesn't Turn Over or Turns Over Slowly**

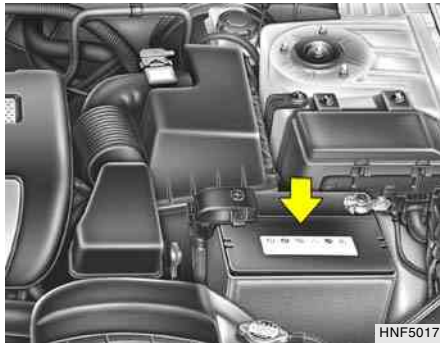

HNF5017

1. If your car has an automatic transaxle, be sure the gear selector lever is in "N" or "P" and the emergency brake is set.
2. Check the battery connections to be sure they are clean and tight.
3. Turn on the interior light. If the light dims or goes out when you operate the starter, the battery is discharged.
4. Check the starter connections to be sure they are securely tightened.
5. Do not push or pull the vehicle to start it. See instructions for "Jump Starting".

D010C02Y-AAT

#### **If Engine Turns Over Normally but Does Not Start**

1. Check fuel level.
2. With the key in the "OFF" position, check all connectors at ignition, coil and spark plugs. Reconnect any that may be disconnected or loose.
3. Check the fuel line in the engine compartment.
4. If the engine still does not start, call a Hyundai dealer or seek other qualified assistance.

D010D01A-AAT

#### **If Engine Stalls While Driving**

1. Reduce your speed gradually, keeping a straight line. Move cautiously off the road to a safe place.
2. Turn on your emergency flashers.
3. Try to start the engine again. If your vehicle will not start, contact a Hyundai dealer or seek other qualified assistance.

## JUMP STARTING

D020A03A-AAT

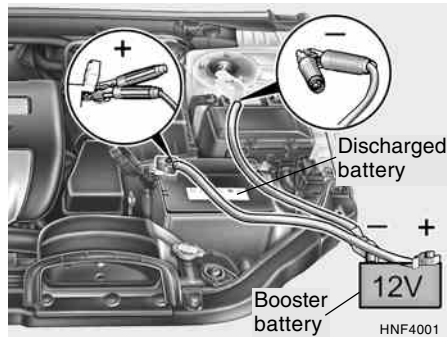
**WARNING:**

The gas produced by the battery during the jump-start operation is highly explosive. If these instructions are not followed exactly, serious personal injury and damage to the vehicle may occur! If you are not sure how to follow this procedure, seek qualified assistance. Automobile batteries contain sulfuric acid. This is poisonous and highly corrosive. When jump starting, wear protective glasses and be careful not to get acid on yourself, your clothing or on the car.

- o If you should accidentally get acid on your skin or in your eyes, immediately remove any contaminated clothing and flush the area with clean water for at least 15 minutes. Then promptly obtain medical attention. If you must be transported to an emergency facility, continue to apply water to the affected area with a sponge or cloth.
- o The gas produced by the battery during the jump-start operation is highly explosive. Do not smoke or allow a spark or an open flame in the vicinity.
- o The battery being used to provide the jump start must be 12-volt. If you cannot determine that it is a 12-volt battery, do not attempt to use it for the jump start.
- o To jump start a car with a discharged battery, follow this procedure exactly:
  1. If the booster battery is installed in another vehicle, be sure the two vehicles are not touching.
  2. Turn off all unnecessary lights and accessories in both vehicles.
  3. Attach the clamps of the jumper cable in the exact location shown on the illustration. First, attach one clamp of the jumper cable to the positive (+) post or cable of the discharged battery.

Then attach the other end of the same cable to the positive (+) post or cable of the booster battery. Next, using the other cable, attach one clamp to the negative (-) post or cable of the booster battery. Then attach the other end of that cable to a solid metal part of the engine of the vehicle with the discharged battery away from the battery. Do not connect the cable to any moving part.

4. Start the engine in the car with the booster battery and let it run for a few minutes. This will help to assure that the booster battery is fully charged. During the jumping operation, run the engine in this vehicle at about 2,000 rpm.
5. Start the engine in the car with the discharged battery using the normal starting procedure. After the engine starts, leave the jumper cables connected and let the engine run at fast idle or about 2,000 rpm for several minutes.
6. Carefully remove the jumper cables in the reverse order of attachment.

If you do not know why your battery became discharged (because the lights were left on, etc.), have the charging system checked by your Hyundai dealer.

## IF THE ENGINE OVERHEATS

D030A02A-AAT

If your temperature gauge indicates overheating, you experience a loss of power, or hear loud pinging or knocking, the engine is probably too hot. If this happens, you should:

1. Pull off the road and stop as soon as it is safe to do so.
2. Place the gear selector lever in "P" (automatic) or neutral (manual transaxle) and set the parking brake. If the air conditioning is on, turn it off.
3. If engine coolant is running out under the car or steam is coming out from the hood, stop the engine. Do not open the hood until the coolant has stopped running or the steaming has stopped. If there is no visible loss of engine coolant and no steam, leave the engine running and check to be sure the engine cooling fan is operating. If the fan is not running, turn the engine off.
4. Check to see if the water pump drive belt is missing. If it is not missing, check to see that it is tight. If the drive belt seems to be satisfactory, check for coolant leaking from the radiator, hoses or under the car. (If the air conditioning had been in use, it is normal for cold water to be draining from it when you stop).

**WARNING:**

**While the engine is running, keep hair, hands and clothing away from moving parts such as the fan and drive belts to prevent injury.**

5. If the water pump drive belt is broken or engine coolant is leaking out, stop the engine immediately and call the nearest Hyundai dealer for assistance.

**WARNING:**

**Do not remove the radiator cap when the engine is hot. This can allow coolant to be blown out of the opening and cause serious burns.**

6. If you cannot find the cause of the overheating, wait until the engine temperature has returned to normal. Then, if coolant has been lost, carefully add coolant to the reservoir (page 6-9) to bring the fluid level in the reservoir up to the halfway mark.
7. Proceed with caution, keeping alert for further signs of overheating. If overheating happens again, call a Hyundai dealer for assistance.

**CAUTION:**

**Serious loss of coolant indicates there is a leak in the cooling system and this should be checked as soon as possible by a Hyundai dealer.**

## SPARE TIRE

D040A02GK-AAT

### TEMPORARY SPARE TIRE

The following instructions for the temporary spare tire should be observed:

1. Check inflation pressure as soon as practical after installing the spare tire, and adjust to the specified pressure. The tire pressure should be periodically checked and maintained at the specified pressure while the tire is stored.

### Spare Tire Pressure

Tire Size	T125/80 D16
Inflation Pressure	420 KPA(60 PSI)

2. The spare tire should only be used temporarily and should be returned to the luggage compartment as soon as the original tire can be repaired or replaced.
3. Continuous use at speeds of over 50 mph (80 km/h) is not recommended.

4. As the temporary spare tire is specifically designed for your car, it should not be used on any other vehicle.
5. The temporary spare tire should not be used on any other wheels, nor should standard tires, snow tires, wheel covers or trim rings be used with the temporary spare wheel. If such use is attempted, damage to these items or other car components may occur.
6. The temporary spare tire pressure should be checked once a month while the tire is stored.



#### CAUTION:

- o Do not use snow chains with your temporary spare tire.
- o Do not use more than one temporary spare tire at a time.
- o Do not tow a trailer while the temporary spare tire is installed.

D040B01NF-GAT

### Handling the Spare Tire

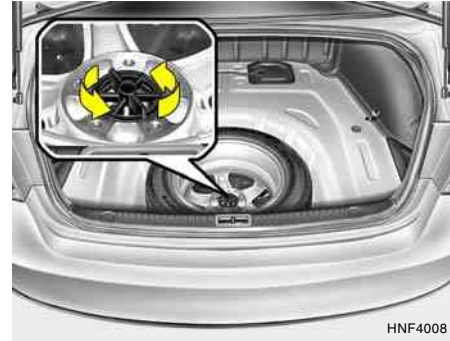

HNF4008

To remove the spare tire, take out the tool receptacle and remove the installation bolt by turning it counterclockwise. To replace the spare tire in its storage compartment, tighten the bolt firmly with your fingers until there is no more play in the spare tire.

## IF YOU HAVE A FLAT TIRE

D050A01A-AAT

If a tire goes flat while you are driving:

1. Take your foot off the accelerator pedal and let the car slow down while driving straight ahead. Do not apply the brakes immediately or attempt to pull off the road as this may cause a loss of control. When the car has slowed to such a speed that it is safe to do so, brake carefully and pull off the road. Drive off the road as far as possible and park on firm, level ground. If you are on a divided highway, do not park in the median area between the two traffic lanes.
2. When the car is stopped, turn on your emergency hazard flashers, set the parking brake and put the transaxle in "P" (automatic) or reverse (manual transaxle).
3. Have all passengers get out of the car. Be sure they all get out on the side of the car that is away from traffic.
4. Change the tire according to the instructions provided as follows.

## CHANGING A FLAT TIRE

D060A01A-AAT



D060A01NF-A

The procedure described on the following pages can be used to rotate tires as well as to change a flat tire. When preparing to change a flat tire, check to be sure the gear selector lever is in "P" (automatic transaxle) or reverse gear (manual transaxle) and that the parking brake is set, then:

D060B01NF-GAT

## 1. Obtain Spare Tire and Tool



D060B01NF-A

Take out the tool receptacle and turn the installation bolt counterclockwise to remove spare tire from the trunk.

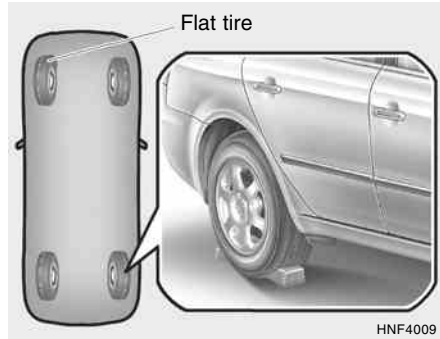

D060C01A-AAT

**2. Block the Wheel**

Block the wheel that is diagonally opposite from the flat to keep the vehicle from rolling when the car is raised on the jack.

D060D01A-AAT

**3. Loosen Wheel Nuts**

The wheel nuts should be loosened slightly before raising the car. To loosen the nuts, turn the wrench handle counterclockwise. When doing this, be sure that the socket is seated completely over the nut so it cannot slip off. For maximum leverage, position the wrench so the handle is to the left as shown in the drawing. Then, while holding the wrench near the end of the handle, push down on it with steady pressure. Do not remove the nuts at this time. Just loosen them about one-half turn.

D060E01A-AAT

**4. Put the Jack in Place**

The base of the jack should be placed on firm, level ground. The jack should be positioned as shown in the drawing.

D060F02E-AAT

## 5. Raising the Car

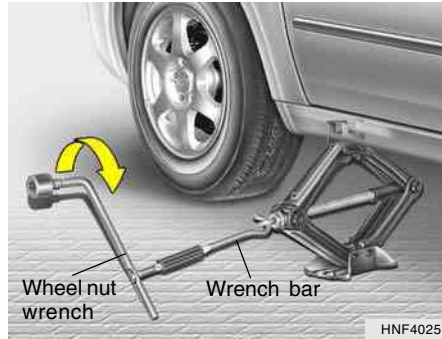

After inserting a wrench bar into the wheel nut wrench, install the wrench bar into the jack as shown in the drawing. To raise the vehicle, turn the wheel nut wrench clockwise. As the jack begins to raise the vehicle, double check that it is properly positioned and will not slip. If the jack is on soft ground or sand, place a board, brick, flat stone or other object under the base of the jack to keep it from sinking.

Raise the car high enough so that the fully inflated spare tire can be installed. To do this, you will need more ground clearance than is required to remove the flat tire.

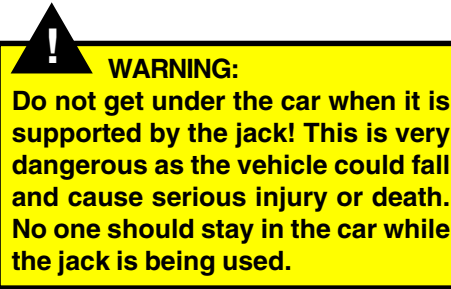

D060G02Y-AAT

## 6. Changing Wheels



Loosen the wheel nuts and remove them with your fingers. Slide the wheel off the studs and lay it flat so it cannot roll away. To put the wheel on the hub, pick up the spare tire, line up the holes with the studs and slide the wheel onto them. If this is difficult, tip the wheel slightly and get the top hole in the wheel lined up with the top stud. Then jiggle the wheel back and forth until the wheel can be slid over the other studs.

**WARNING:**

Wheels and wheel covers may have sharp edges. Handle them carefully to avoid possible severe injury. Before putting the wheel into place, be sure that there is nothing on the hub or wheel (such as mud, tar, gravel, etc.) that interferes with the wheel from fitting solidly against the hub.

**WARNING:**

If there is, remove it. If there is not good contact on the mounting surface between the wheel and hub, the wheel nuts could come loose and cause the loss of a wheel. Loss of a wheel may result in loss of control of the vehicle. This may cause serious injury or death.

D060H02O-AAT

**7. Reinstall Wheel Nuts**

To reinstall the wheel, hold it on the studs, put the wheel nuts on the studs and tighten them finger tight. The nuts should be installed with their small diameter ends directed inward. Jiggle the tire to be sure it is completely seated, then tighten the nuts as much as possible with your fingers again.

D060I01E-AAT

**8. Lower Vehicle and Tighten Nuts**

D060I01NF

Lower the car to the ground by turning the wheel nut wrench counterclockwise.



HNF4013-A

Then position the wrench as shown in the drawing and tighten the wheel nuts. Be sure the socket is seated completely over the nut. Do not stand on the wrench handle or use an extension pipe over the wrench handle.

Go around the wheel tightening every other nut until they are all tight. Then double-check each nut for tightness. After changing wheels, have a technician tighten the wheel nuts to their proper torque as soon as possible.

**Wheel nut tightening torque:**

Steel wheel & aluminium alloy wheel:  
65-80 lb.ft (900-1,100 kg.cm)

D060J02O-AAT

**After Changing Wheels**

HNF5016-A

If you have a tire gauge, remove the valve cap and check the air pressure. If the pressure is lower than recommended, drive slowly to the nearest service station and inflate to the correct pressure. If it is too high, adjust it until

it is correct. Always reinstall the valve cap after checking or adjusting tire pressure. If the cap is not replaced, air may leak from the tire. If you lose a valve cap, buy another and install it as soon as possible.

After you have changed wheels, always secure the flat tire in its place and return the jack and tools to their proper storage locations.

## IF YOUR VEHICLE MUST BE TOWED

D080A01O-GAT

If your vehicle has to be towed, it should be done by your Hyundai dealer or a commercial tow truck service. This will help assure that your vehicle is not damaged in towing. Also, professionals are generally aware of local laws governing towing. In any case, rather than risk damage to your car, it is suggested that you show this information to the tow truck operator. Be sure that a safety chain system is used and that all local laws are observed.

It is recommended that your vehicle be towed with a wheel lift and dollies or flatbed equipment with all the wheels off the ground.



### CAUTION:

- o Your vehicle can be damaged if towed incorrectly!
- o Be sure the transaxle is in neutral.
- o When the engine will not start, be sure the steering is unlocked by placing the key in the "ACC" position.

D080B01O-GAT

## Towing the Vehicle

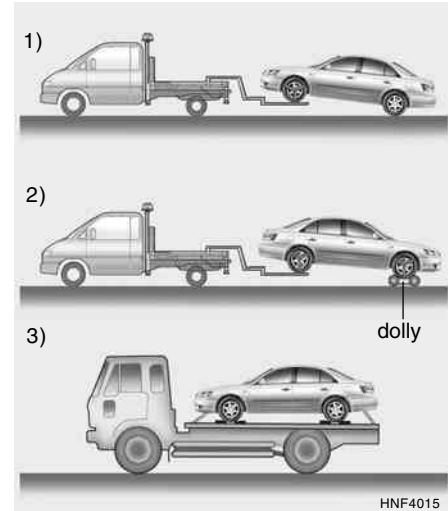

Your vehicle can be towed by wheel lift type truck (1), (2) or flatbed equipment (3).

**CAUTION:**

- o When towing the vehicle, take care not to cause damage to the bumper or underbody of the vehicle.

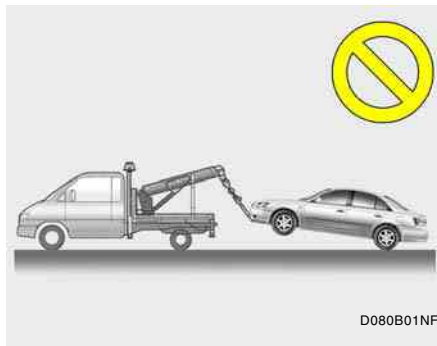

- o Do not tow with sling type truck as this may cause damage to the bumper or underbody of the vehicle.

- 1) If the vehicle is being towed with the rear wheels on the ground, be sure the parking brake is released.

**NOTE:**

Before towing, check the level of the automatic transaxle fluid. If it is below the "HOT" range on the dipstick, add fluid. If you cannot add fluid, a towing dolly must be used.

- 2) If any of the loaded wheels or suspension components are damaged or the vehicle is being towed with the front wheels on the ground, use a towing dolly under the front wheels.
- o Manual Transaxle:  
If you do not use a towing dolly, place the ignition key in the "ACC" position and put the transaxle in "N (Neutral)".

**CAUTION:**

Do not tow with the key removed or in the "LOCK" position when towing from the rear without a towing dolly.

- o Automatic Transaxle:  
Be sure to use a towing dolly under the front wheels.

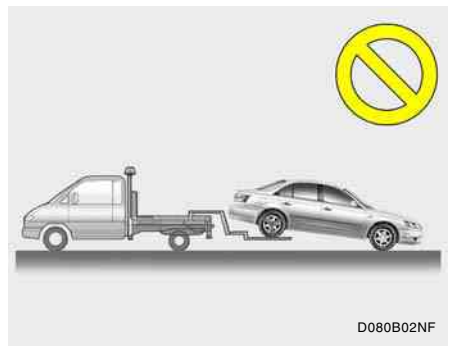
**CAUTION:**

A vehicle with an automatic transaxle should never be towed from the rear with the front wheels on the ground. This can cause serious damage to the transaxle.

- 3) It is recommended that your vehicle be towed with all the wheels off the ground.

## EMERGENCY TOWING

D080D01NF-AAT



D080D02NF-A

For emergency towing when no commercial tow vehicle is available, attach a tow cable, chain or strap to the towing hook under the front of your car. Do not attempt to tow your vehicle in this manner on any unpaved surface. This could result in serious damage to your car. Nor should towing be attempted if the wheels, drive train, axles, steering or brakes are damaged. Before towing, be sure the transaxle is in neutral and the key is in "ACC" (with the engine off) or in the "ON" position (with the engine running). A driver must be in the towed car to steer it and operate the brakes.

**NOTE:**

Before towing, check the level of the automatic transaxle fluid. If it is below the "HOT" range on the dipstick, add fluid. If you cannot add fluid, a towing dolly must be used.

**CAUTION:**

If the car is being towed with all four wheels on the ground, it can be towed only from the front. Be sure that the transaxle is in neutral. Do not tow at speeds greater than 30 mph (50 km/h) and for more than 15 miles (25 km). Be sure the steering is unlocked by placing the key in the "ACC" position. A driver must be in the towed vehicle to operate the steering and brakes.

## IF YOU LOSE YOUR KEYS

13

D120A01A-AAT

If you lose your keys, many Hyundai dealers can make you a new key if you have your key number.

If you lock the keys inside your car and you cannot obtain a new key, many Hyundai dealers can use special tools to open the door for you.

## CORROSION PREVENTION & APPEARANCE CARE

Corrosion Protection .....	4-2
To Help Prevent Corrosion .....	4-2
Washing and Waxing .....	4-3
Cleaning the Interior .....	4-5



## CORROSION PROTECTION

E010A01A-AAT

**Protecting Your Hyundai from Corrosion**

By using the most advanced design and construction practices to combat corrosion, Hyundai produces cars of the highest quality. However, this is only part of the job. To achieve the long-term corrosion resistance your Hyundai can deliver, the owner's cooperation and assistance is also required.

E010B01A-AAT

**Common Causes of Corrosion**

The most common causes of corrosion on your car are:

- o Road salt, dirt and moisture that is allowed to accumulate underneath the car.
- o Removal of paint or protective coatings by stones, gravel, abrasion or minor scrapes and dents which leave unprotected metal exposed to corrosion.

E010C01A-AAT

**High-Corrosion Areas**

If you live in an area where your car is regularly exposed to corrosive materials, corrosion protection is particularly important. Some of the common causes of accelerated corrosion are road salts, dust control chemicals, ocean air and industrial pollution.

E010D01A-AAT

**Moisture Breeds Corrosion**

Moisture creates the conditions in which corrosion is most likely to occur. For example, corrosion is accelerated by high humidity, particularly when temperatures are just above freezing. In such conditions, the corrosive material is kept in contact with the car surfaces by moisture that is slow to evaporate.

Mud is particularly corrosive because it is slow to dry and holds moisture in contact with the vehicle. Although the mud appears to be dry, it can still retain the moisture and promote corrosion.

High temperatures can also accelerate corrosion of parts that are not properly ventilated so the moisture can be dispersed. For all these reasons, it is particularly important to keep your car clean and free of mud or accumulations of other materials. This applies not only to the visible surfaces but particularly to the underside of the car.

## TO HELP PREVENT CORROSION

E020A01A-AAT

You can help prevent corrosion from getting started by observing the following:

E020B01A-AAT

**Keep Your Car Clean**

The best way to prevent corrosion is to keep your car clean and free of corrosive materials. Attention to the underside of the car is particularly important.

- o If you live in a high-corrosion area — where road salts are used, near the ocean, areas with industrial pollution, acid rain, etc.—, you should take extra care to prevent corrosion. In winter, hose off the underside of your car at least once a month and be sure to clean the underside thoroughly when winter is over.
- o When cleaning underneath the car, give particular attention to the components under the fenders and other areas that are hidden from view. Do a thorough job; just dampening the accumulated mud rather than washing it away will accelerate corrosion rather than prevent it. Water under high pressure and steam are particularly effective in removing accumulated mud and corrosive materials.

- o When cleaning lower door panels, rocker panels and frame members, be sure that drain holes are kept open so that moisture can escape and not be trapped inside to accelerate corrosion.

E020C01A-AAT

### Keep Your Garage Dry

Don't park your car in a damp, poorly ventilated garage. This creates a favorable environment for corrosion. This is particularly true if you wash your car in the garage or drive it into the garage when it is still wet or covered with snow, ice or mud. Even a heated garage can contribute to corrosion unless it is well ventilated so moisture is dispersed.

E020D02A-AAT

### Keep Paint and Trim in Good Condition

Scratches or chips in the finish should be covered with "touch-up" paint as soon as possible to reduce the possibility of corrosion. If bare metal is showing through, the attention of a qualified body and paint shop is recommended.

**Bird droppings :** Bird droppings are highly corrosive and may damage painted surfaces in just a few hours. Always remove bird droppings as soon as possible.

E020E01A-AAT

### Don't Neglect the Interior

Moisture can collect under the floor mats and carpeting to cause corrosion. Check under the mats periodically to be sure the carpeting is dry. Use particular care if you carry fertilizers, cleaning materials or chemicals in the car. These should be carried only in proper containers and any spills or leaks should be cleaned up, flushed with clean water and thoroughly dried.

E030A01A-AAT

### Washing Your Hyundai

Never wash your car when the surface is hot from being in the sun. Always wash your car in the shade.

Wash your car frequently. Dirt is abrasive and can scratch the paint if it is not removed. Air pollution or acid rain may damage the paint and trim through chemical action if pollutants are allowed to remain in contact with the surface. If you live near the ocean or in an area where road salts or dust control chemicals are used, you should pay particular attention to the underside of the car. Start by rinsing the car to remove dust and loose dirt. In winter, or if you have driven through mud or muddy water, be sure to thoroughly clean the underside as well. Use a hard direct stream of water to remove accumulations of mud or corrosive materials. Use a good quality car-washing solution and follow the manufacturer's directions on the package. These are available at your Hyundai dealer or auto parts outlet. Don't use strong household detergents, gasoline, strong solvents or abrasive cleaning powders as these may damage the finish.

Use a clean sponge or cloth, rinse it frequently and don't damage the finish by rubbing too hard. For stubborn spots, dampen them frequently and remove them a little at a time.

To clean whitewall tires, use a stiff brush or soapy steel-wool scouring pad.

To clean plastic wheel covers, use a clean sponge or soft cloth and water.

To clean cast aluminum alloy wheels, use a mild soap or neutral detergent. Do not use abrasive cleaners. Protect the bare-metal surfaces by cleaning, polishing and waxing. Because aluminum is subject to corrosion, be sure to give aluminum alloy wheels special attention in winter. If you drive on salted roads, clean the wheels thoroughly afterwards.

After washing, be sure to rinse thoroughly. If soapy water dries on the finish, streaking will result.

When the weather is warm and the humidity low, you may find it necessary to rinse each section immediately after washing to avoid streaking.

After rinsing, dry the car using a damp chamois or soft, absorbent cloth. The reason for drying the car is to remove water from the car so it will dry without water spots. Don't rub, this can damage the finish.

If you find any nicks or scratches in the paint, use touch-up paint to cover them to prevent corrosion. To protect the paintwork of the car against corrosion, you must clean your Hyundai (at least once a month). Give special attention to the removal of salt, mud and other substances on the underside of the splashboards of the car. Make sure that the outlets and the underside of the doors are open. Paint damage can be caused by small accumulation of tar, industrial precipitation, tree resin, insects and bird droppings, when not removed immediately. If water alone is not strong enough to remove the accumulated dirt, use a mild car washing solution. Be sure to rinse the surface after washing to remove the solution. Never allow the solution to dry on the painted surfaces.

E030B01A-AAT

### Spot Cleaning

Don't use gasoline, strong solvents or corrosive cleaning agents. These can damage the finish of the car. To remove road tar, use turpentine on a clean, soft cloth. Be gentle.

To remove dead insects or tree sap, use warm water and mild soap or car-washing solution. Soak the spot and rub gently. If the paint has lost its luster, use a commercial car-cleaning polish.

E030C01A-AAT

### Polishing and Waxing

Always wash and dry the car before polishing or waxing or using a combination cleaner and wax. Use a good quality commercial product and follow the manufacturer's directions on the container. Polish and wax the bright trim pieces as well as the paint.

E030D01A-AAT

### When to Wax Again

You should polish and wax the car again when water no longer beads on a clean surface but spreads out over a larger area.

## CLEANING THE INTERIOR

E030E01A-AAT

### Maintaining Bumpers

Special precautions must be observed to preserve the appearance of the bumpers on your Hyundai. They are:

- o Be careful not to spill battery electrolyte or hydraulic brake fluid on the bumpers. If you do, wash it off immediately with clean water.
- o Be gentle when cleaning the bumper surfaces. They are made of soft plastic and the surface can be damaged if mistreated. Do not use abrasive cleaners. Use warm water and mild soap or car-washing solution.
- o Do not expose the bumpers to high temperatures. For example, if you have your car repainted, do not leave the bumpers on the car if the car is going to be placed in a high-temperature paint booth.

E040A01A-AAT

### To Clean the Vinyl Upholstery

To clean the vinyl upholstery, first remove loose dirt and dust with a vacuum cleaner. Then apply a solution of mild soap or detergent and water using a clean sponge or soft cloth. Allow this to stay on the surface to loosen the dirt, then wipe with a clean damp sponge or cloth. If all the dirt stains are not removed, repeat this procedure until the upholstery is clean. Do not use gasoline, solvent, paint thinner or other strong cleaners.

E040B01A-AAT

### To Clean the Leather Upholstery (If Installed)

In the normal course of use, leather upholstered surfaces will, like any material, pick-up dust and dirt. This dust and dirt must be cleaned off or it may work into the surface of the leather, causing damage.

Fine leather needs care, and should be cleaned when necessary. Washing leather thoroughly with soap and water will keep your leather lustrous, beautiful and ensure you have many years of wear.

Take a piece of cheese cloth and using any mild soap and lukewarm water, work up a good lather. Thoroughly wash the leather. Wipe clean with a slightly damp cloth and dry with soft cloth. Do this as often as the leather becomes soiled.

During tanning operations, sufficient oils are incorporated through processing that none need be applied during the life of the leather. Oil applied to the finished surface will in no way help the leather and may do more harm than good. Varnishes and furniture polishes should never be used under any conditions.

E040C01A-AAT

### **Cleaning the Carpets**

Use a foam-type carpet cleaner. Cleaners of this type are available in aerosol cans in liquid form or powder. Read the instructions and follow them exactly. Using a vacuum cleaner with the appropriate attachment, remove as much dirt from the carpets as possible. Apply the foam following the manufacturer's directions, then rub in overlapping circles. Do not add water. These cleaners work best when the carpet is kept as dry as possible.

E040D01A-AAT

### **Cleaning the Seat Belts**

To clean the seat belts, use a cloth or sponge with mild soap or detergent and warm water. Do not use strong detergents, dye, bleach or abrasive materials on the seat belts as this may weaken the fabric.

While cleaning the belts, inspect them for excessive wear, cuts, fraying or other signs of damage and replace them if necessary.

E040E01A-AAT

### **Cleaning the Windows**

You may use any household window cleaner on the windows. However, when cleaning the inside of the rear window be careful not to damage the rear window defroster wiring.

## **ANY QUESTIONS?**

E050A01A-AAT

If you have any questions about the care of your car, consult your Hyundai dealer.

# VEHICLE MAINTENANCE REQUIREMENTS

Maintenance Intervals .....	5-2
Scheduled Maintenance .....	5-4
Maintenance under Severe Usage Conditions .....	5-6
Explanation of Scheduled Maintenance Items .....	5-7

**MAINTENANCE INTERVALS**

F010A01A-AAT

**Service Requirements**

To ensure that you receive the greatest number of miles of satisfying operation from your Hyundai, certain maintenance procedures must be performed. Although careful design and engineering have reduced these to a minimum, those that are required are of the utmost importance.

It is your responsibility to have these maintenance procedures performed to comply with the terms of the warranties covering your new Hyundai. The Owner's Handbook supplied with your new vehicle provides further information about these warranties.

F010B01A-AAT

**Maintenance Requirements**

The maintenance required for your Hyundai can be divided into three main areas:

- o Specified scheduled procedures
- o General checks
- o Do-it-yourself maintenance

F010C01A-AAT

**Specified Scheduled Procedures**

These are the procedures such as inspections, adjustments and replacements that are listed in the maintenance charts starting on page 5-4. These procedures must be performed at the intervals shown in the maintenance schedule to assure that your warranty remains in effect. Although it is strongly recommended that they be performed by the trained technicians at your Hyundai dealer, these procedures may be performed at any qualified service facility.

It is suggested that genuine Hyundai service parts be used for any required repairs or replacements. Other parts of equivalent quality such as engine oil, engine coolant, manual or auto transaxle oil, brake fluid and so on which are not supplied by Hyundai Motor Company or its distributor may be used without affecting your warranty coverage but you should always be sure these are equivalent to the quality of the original Hyundai parts. Your Owner's Handbook provides further information about your warranty coverage.

## SCHEDULED MAINTENANCE REQUIREMENTS

F010D02A-AAT

### General Checks

These are the regular checks you should perform when you drive your Hyundai or you fill the fuel tank. A list of these items will be found on page 6-4.

F010E01A-AAT

### Do-It-Yourself Maintenance

If you are mechanically inclined, own a few tools that are required and want to take the time to do so, you can inspect and service a number of items. For more information about doing it yourself, see Section 6.

F010F01A-AAT

### A Few Tips

- Whenever you have your Hyundai serviced, keep copies of the service records in your glove box. This will help ensure that you can document that the required procedures have been performed to keep your warranties in effect. This is especially important when service is not performed by an authorized Hyundai dealer.
- If you choose to do your own maintenance and repairs, you may find it helpful to have an official Hyundai Shop Manual. A copy of this publication may be purchased at your Hyundai dealer's parts department.

F020A02Y-AAT

- Inspection should be performed any time a malfunction is experienced or suspected.
- Receipts for all emission control system services should be retained to demonstrate compliance with conditions of the emissions system warranty.
- After 120 months or 150,000 miles (240,000 km), continue to follow the prescribed maintenance intervals.
- For severe usage maintenance requirements, see page 5-6 of this section.



**SCHEDULED MAINTENANCE**

F030A01NF-AAT

The following maintenance services must be performed to ensure good emission control and performance. Keep receipts for all vehicle emission services to protect your warranty. Where both mileage and time are shown, the frequency of service is determined by whichever occurs first.

F030B03NF-AAT

R :Replace I : Inspect and, after Inspection, clean, adjust, repair or replace if necessary.

No.	DESCRIPTION	MILES X 1000																			
		7.5	15	22.5	30	37.5	45	52.5	60	67.5	75	82.5	90	97.5	105	112.5	120	127.5	135	142.5	150
		KILOMETERS X 1000																			
		MONTHS																			
		6	12	18	24	30	36	42	48	54	60	66	72	78	84	90	96	102	108	114	120
EMISSION CONTROL ITEMS																					
1	ENGINE OIL AND FILTER	R	R	R	R	R	R	R	R	R	R	R	R	R	R	R	R	R	R	R	R
2	FUEL FILTER					R					R					R					R
3	FUEL LINES, FUEL HOSES AND CONNECTIONS	I	I	I	I	I	I	I	I	I	I	I	I	I	I	I	I	I	I	I	I
4	VACUUM AND CRANKCASE VENTILATION HOSES				I					I				I				I			I
5	VAPOR HOSE AND FUEL FILLER CAP	I	I	I	I	I	I	I	I	I	I	I	I	I	I	I	I	I	I	I	I
6	AIR CLEANER FILTER		I		R		I		R		I		R		I		R		I		R
7	VALVE CLEARANCE									I									I		
8	SPARK PLUGS (IRIDIUM COATED)														R						
9	FUEL TANK AIR FILTER		I		R		I		R		I		R		I		R		I		R
10	ELECTRONIC THROTTLE CONTROL							I								I					

F030C01NF-AAT

R : Replace I : Inspect and, after inspection, clean, adjust, repair or replace if necessary

No.	DESCRIPTION	MILES X 1000	7.5	15	22.5	30	37.5	45	52.5	60	67.5	75	82.5	90	97.5	105	112.5	120	127.5	135	142.5	150	
		KILOMETERS X 1000	12	24	36	48	60	72	84	96	108	120	132	144	156	168	180	192	204	216	228	240	
		MONTHS	6	12	18	24	30	36	42	48	54	60	66	72	78	84	90	96	102	108	114	120	
GENERAL ITEMS																							
1	DRIVE BELT (AUTO-TENSIONER, ALT, P/STR'G, A/CON, W/PUMP)				I					I									I				I
2	COOLANT	See Note *1																					
3	MANUAL TRANSAXLE OIL				I					I					I				I				I
4	AUTOMATIC TRANSAXLE FLUID		I		I			I		I			I			R			I			I	
5	BRAKE FLUID				I					I					I				I				I
6	BRAKE HOSES AND LINES		I		I			I		I			I			I			I			I	
7	REAR BRAKE DRUMS/LININGS, PARKING BRAKE				I					I					I				I				I
8	BRAKE PADS, CALIPERS AND ROTORS		I		I			I		I			I			I			I			I	
9	EXHAUST PIPE AND MUFFLER		I		I			I		I			I			I			I			I	
10	SUSPENSION MOUNTING BOLTS	I	I	I	I	I	I	I	I	I	I	I	I	I	I	I	I	I	I	I	I	I	I
11	STEERING GEAR BOX, LINKAGE & BOOTS / LOWER ARM BALL JOINT, UPPER ARM BALL JOINT	I	I	I	I	I	I	I	I	I	I	I	I	I	I	I	I	I	I	I	I	I	I
12	POWER STEERING PUMP, BELT AND HOSES		I		I			I		I			I			I			I			I	
13	DRIVE SHAFTS AND BOOTS		I		I			I		I			I			I			I			I	
14	AIR CONDITIONING REFRIGERANT		I		I			I		I			I			I			I			I	
15	AIR CONDITIONER FILTER (FOR EVAPORATOR AND BLOWER UNIT)	See Note *2																					

Note:

- \*1. FOR THE FIRST TIME, REPLACE THE COOLANT AT 60,000 MILES (96,000 KM) OR 60 MONTHS.  
AFTER THAT, REPLACE IT EVERY 30,000 MILES (48,000 KM) OR 24 MONTHS.
- \*2. FOR EVERY 12 MONTHS OR 10,000 MILES (15,000 KM), WHICHEVER OCCURS FIRST : "R"

## MAINTENANCE UNDER SEVERE USAGE CONDITIONS

F040A01NF-AAT

The following items must be serviced more frequently on cars normally used under severe driving conditions. Refer to the chart below for the appropriate maintenance intervals.

R : Replace I : Inspect and, after inspection, clean, adjust, repair or replace if necessary

MAINTENANCE ITEM	MAINTENANCE OPERATION	MAINTENANCE INTERVALS	DRIVING CONDITION
ENGINE OIL AND FILTER	R	EVERY 3,000 MILES (4,800 KM) OR 3 MONTHS	A, B, C, D, E, F, G, H, I, K
AIR CLEANER FILTER	I	MORE FREQUENTLY	C, E
SPARK PLUGS	R	MORE FREQUENTLY	B, H
BRAKE PADS, CALIPERS AND ROTORS	I	MORE FREQUENTLY	C, D, G, H
REAR BRAKE DRUMS/LININGS, PARKING BRAKE	I	MORE FREQUENTLY	C, D, G, H
STEERING GEAR BOX, LINKAGE & BOOTS/ LOWER ARM BALL JOINT, UPPER ARM BALL JOINT	I	MORE FREQUENTLY	C, D, E, F, G, H, I
DRIVE SHAFTS AND BOOTS	I	EVERY 7,500 MILES (12,000 KM) OR 6 MONTHS	C, D, E, F
MANUAL TRANSAXLE OIL	R	EVERY 60,000 MILES (96,000 KM)	A, C, D, E, F, G, H, I, J
AIR CONDITIONER FILTER (FOR EVAPORATOR AND BLOWER UNIT)	R	MORE FREQUENTLY	C, E
AUTOMATIC TRANSAXLE FLUID	R	EVERY 30,000 MILES (48,000 KM)	A, C, E, F, G, H, I

### SEVERE DRIVING CONDITIONS

- A - Repeatedly driving short distance of less than 5 miles (8km) in normal temperature or less than 10 miles (16km) in freezing temperature
- B - Extensive engine idling or low speed driving for long distances
- C - Driving on rough, dusty, muddy, unpaved, graveled or salt- spread roads
- D - Driving in areas using salt or other corrosive materials or in very cold weather
- E - Driving in sandy areas

- F - Driving in heavy traffic area over 90°F (32°C)
- G - Driving on uphill, downhill, or mountain road
- H - Towing a Trailer, or using a camper, or roof rack
- I - Driving as a patrol car, taxi, other commercial use or vehicle towing
- J - Driving over 100 MPH (170 Km/h)
- K - Frequently driving in stop-and-go conditions

**EXPLANATION OF SCHEDULED MAINTENANCE ITEMS**

F060M01A-AAT

**o Engine Oil and Filter**

The engine oil and filter should be changed at the intervals specified in the maintenance schedule. If the car is being driven in severe conditions, more frequent oil and filter changes are required.

F060C01A-AAT

**o Fuel Filter**

A clogged filter can limit the speed at which the vehicle may be driven, damage the emission system and cause hard starting. If an excessive amount of foreign matter accumulates in the fuel tank, the filter may require replacement more frequently.

After installing a new filter, run the engine for several minutes, and check for leaks at the connections. Fuel filters should be installed by trained technicians.

F060B01NF-GAT

**o Drive Belts**

Inspect all drive belts for evidence of cuts, cracks, excessive wear or oil saturation and replace if necessary. Drive belts should be checked periodically for proper tension.

F060D01A-AAT

**o Fuel Lines, Fuel Hoses and Connections**

Check the fuel lines, fuel hoses and connections for leakage and damage. Have a trained technician replace any damaged or leaking parts immediately.

F060F01A-AAT

**o Vacuum, Crankcase Ventilation Hoses**

Inspect the surface of hoses for evidence of heat and/or mechanical damage. Hard and brittle rubber, cracking, tears, cuts, abrasions, and excessive swelling indicate deterioration. Particular attention should be paid to examine those hose surfaces nearest to high heat sources, such as the exhaust manifold.

Inspect the hose routing to assure that the hoses do not come in contact with any heat source, sharp edges or moving component which might cause heat damage or mechanical wear. Inspect all hose connections, such as clamps and couplings, to make sure they are secure, and that no leaks are present. Hoses should be replaced immediately if there is any evidence of deterioration or damage.

F060G01A-AAT

### o Vapor Hose and Fuel Filler Cap

The vapor hose and fuel filler cap should be inspected at those intervals specified in the maintenance schedule. Make sure that a new vapor hose or fuel filler cap is correctly replaced.

F060H01A-AAT

### o Air Cleaner Filter

A Genuine Hyundai air cleaner filter is recommended when the filter is replaced.

F060J01A-AAT

### o Spark Plugs

Make sure to install new spark plugs of the correct heat range.

F060N02E-AAT

### o Valve Clearance

Inspect excessive valve noise and/or engine vibration and adjust if necessary. A qualified technician should perform the operation.

F070C01A-AAT

### o Coolant

The coolant should be changed at the intervals specified in the maintenance schedule.

F070D01A-AAT

### o Manual Transaxle Oil

Inspect the manual transaxle oil according to the maintenance schedule.

#### NOTE:

**If the oil level is low, check for possible leaks before adding oil. Do not overfill.**

F070E06A-AAT

### o Automatic Transaxle Fluid

The fluid level should be in the "HOT" range of the dipstick, after the engine and transaxle are at normal operating temperature. Check the automatic transaxle fluid level with the engine running and the transaxle in neutral, with the parking brake properly applied. Use HYUNDAI GENUINE ATF SP III, DIAMOND ATF SP III, SK ATF SP III or other brands meeting the SP III specification approved by Hyundai Motor Co. when adding or changing fluid. Using the wrong ATF may result in damage to the ATM.

F070F01A-AAT

### o Brake Hoses and Lines

Visually check for proper installation, chafing, cracks, deterioration and any leakage. Replace any deteriorated or damaged parts immediately.

F070G02A-AAT

### o Brake Fluid

Check brake fluid level in the brake fluid reservoir. The level should be between "MIN" and "MAX" marks on the side of the reservoir. Use only hydraulic brake fluid conforming to DOT 3 or DOT 4.

F070H01A-AAT

### o Rear Brake Drums and Linings/ Parking Brake

Check the rear brake drums and linings for scoring, burning, leaking fluid, broken parts, and excessive wear. Inspect the parking brake system including the parking brake lever and cables. For detailed service procedures, refer to the Shop Manual.

F070J01A-AAT

**o Brake Pads, Calipers and Rotors**

Check the pads for excessive wear, discs for run out and wear, and calipers for fluid leakage.

F070K01A-AAT

**o Exhaust Pipe and Muffler**

Visually inspect the exhaust pipes, muffler and hangers for cracks, deterioration, or damage. Start the engine and listen carefully for any exhaust gas leakage. Tighten connections or replace parts as necessary.

F070L01A-AAT

**o Suspension Mounting Bolts**

Check the suspension connections for looseness or damage. Retighten to the specified torque.

F070M01Y-AAT

**o Steering Gear Box, Linkage & Boots/  
Lower Arm Ball Joint, Upper Arm Ball  
Joint**

With the vehicle stopped and engine off, check for excessive free-play in the steering wheel. Check the linkage for bends or damage. Check the dust boots and ball joints for deterioration, cracks, or damage. Replace any damaged parts.

F070N01A-AAT

**o Power Steering Pump, Belt and Hoses**

Check the power steering pump and hoses for leakage and damage. Replace any damaged or leaking parts immediately. Inspect the power steering belt for evidence of cuts, cracks, excessive wear, oiliness and proper tension. Replace or adjust it if necessary.

F070P01A-AAT

**o Drive Shafts and Boots**

Check the drive shafts, boots and clamps for cracks, deterioration, or damage. Replace any damaged parts and, if necessary, repack the grease.

F070Q01A-AAT

**o Air Conditioning Refrigerant**

Check the air conditioning lines and connections for leakage and damage. Check air conditioning performance according to the relevant shop manual if necessary.

# DO-IT-YOURSELF MAINTENANCE

Engine Compartment .....	6-2
General Checks .....	6-4
Checking the Engine Oil .....	6-5
Changing the Engine Oil and Filter .....	6-6
Checking and Changing the Engine Coolant .....	6-8
Spark Plugs .....	6-11
Changing the Air Cleaner Filter .....	6-14
Checking the Transaxle Oil (Manual) .....	6-17
Checking the Transaxle Fluid (Automatic) .....	6-18
Checking the Brakes .....	6-20
Air Conditioning Care .....	6-21
Changing the Air Conditioner Filter .....	6-22
Checking Drive Belts .....	6-24
Checking and Replacing Fuses .....	6-25
Checking the Battery .....	6-27
Power Steering Fluid Level .....	6-29
Headlight Aiming Adjustment .....	6-30
Replacement of Light Bulbs .....	6-31
Bulb Wattages .....	6-38
Fuse Panel Description .....	6-39

# 6

## 2 ENGINE COMPARTMENT

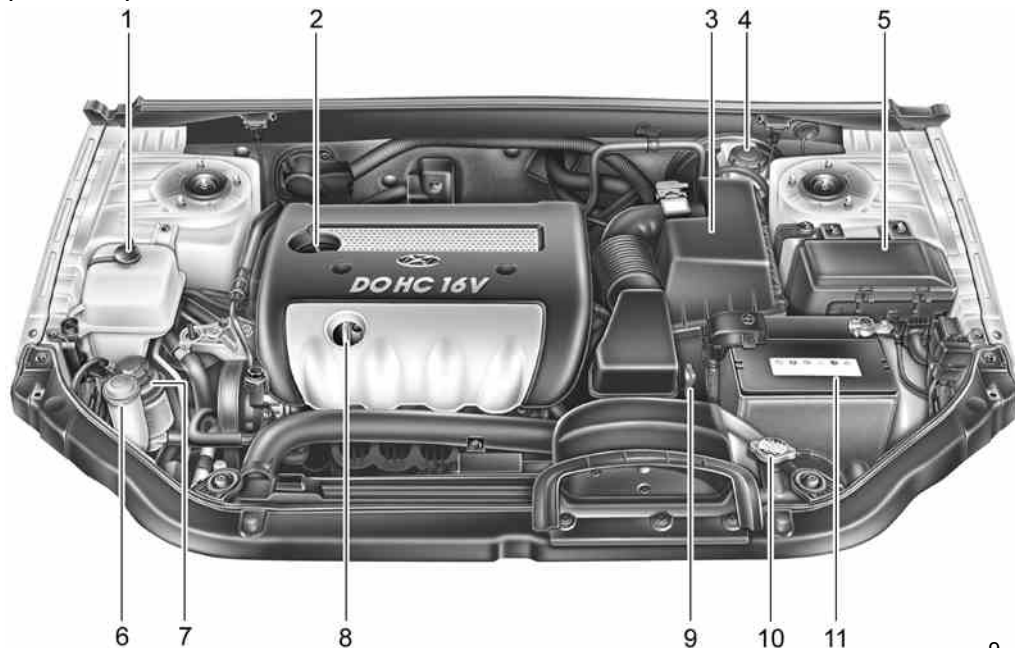
G010B01NF-AAT  
(2.4 DOHC)**CAUTION:**

When inspecting or servicing the engine, you should handle tools and other heavy objects carefully so that the plastic cover of the engine is not damaged.

1. Coolant reservoir cap
2. Engine oil filler cap
3. Air cleaner
4. Brake fluid reservoir

5. Fuse and relay box
6. Windshield washer fluid reservoir
7. Power steering fluid reservoir
8. Engine oil level dipstick

9. Automatic transaxle oil level dipstick (If Installed)
10. Radiator cap
11. Battery

G010B01NF



G010A01NF-AAT  
**(3.3 V6)**

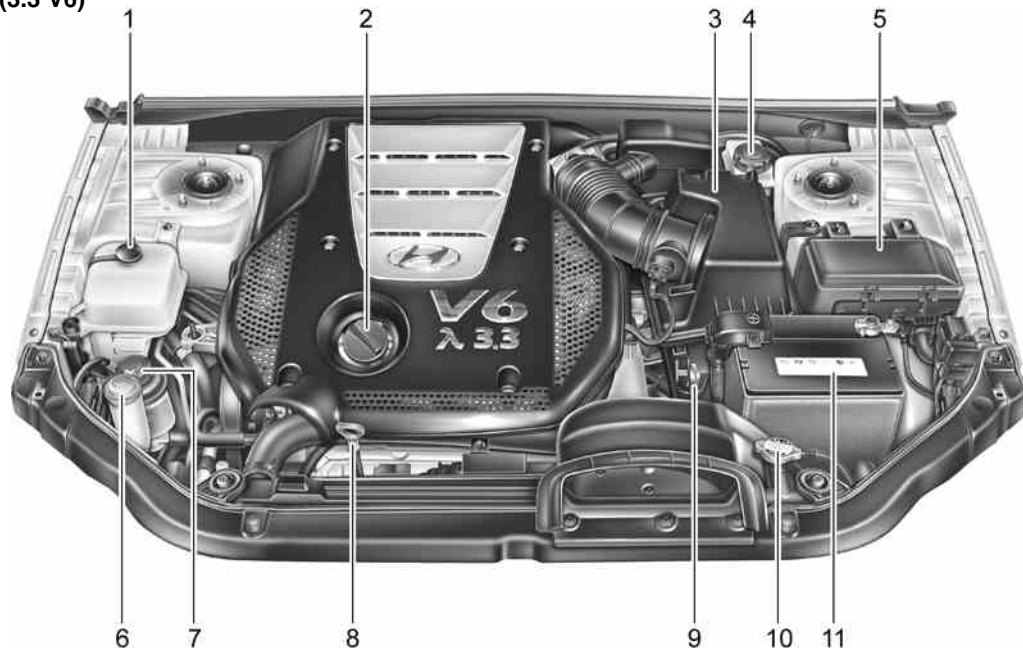

1. Coolant reservoir cap
2. Engine oil filler cap
3. Air cleaner
4. Brake fluid reservoir

5. Fuse and relay box
6. Windshield washer fluid reservoir
7. Power steering fluid reservoir
8. Engine oil level dipstick

9. Automatic transaxle oil level dipstick
10. Radiator cap
11. Battery



**CAUTION:**

When inspecting or servicing the engine, you should handle tools and other heavy objects carefully so that the plastic cover of the engine is not damaged.

G010A01NF

## GENERAL CHECKS

G020A01NF-AAT

**Engine Compartment**

The following should be checked regularly:

- o Engine oil level and condition
- o Transaxle fluid level and condition
- o Brake fluid level
- o Engine coolant level
- o Windshield washer fluid level
- o Accessory drive belt condition
- o Engine coolant hose condition
- o Fluid leaks (on or below components)
- o Power steering fluid level
- o Battery condition
- o Air filter condition
- o Engine vibration

G020B01A-AAT

**Vehicle Exterior**

The following should be checked monthly:

- o Overall appearance and condition
- o Wheel condition and wheel nut torque
- o Exhaust system condition
- o Light condition and operation
- o Windshield glass condition
- o Wiper blade condition
- o Paint condition and body corrosion
- o Fluid leaks
- o Door and hood lock condition
- o Tire pressure and condition (including spare tire)

G020C01A-AAT

**Vehicle Interior**

The following should be checked each time when the vehicle is driven:

- o Lights operation
- o Windshield wiper operation
- o Horn operation
- o Defroster, heating system operation (and air conditioning, if installed)
- o Steering operation and condition
- o Mirror condition and operation
- o Turn signal operation
- o Accelerator pedal operation
- o Brake operation, including parking brake
- o Manual transaxle operation, including clutch operation
- o Automatic transaxle operation, including "Park" mechanism operation
- o Seat control condition and operation
- o Seat belt condition and operation
- o Sun visor operation

If you notice anything that does not operate correctly or appears to be functioning correctly, inspect it carefully and seek assistance from your Hyundai dealer if service is needed.

## CHECKING THE ENGINE OIL

G030A01A-AAT

Engine oil is essential to the performance and service of the engine. It is suggested that you check the oil level at least once a week in normal use and more often if you are on a trip or driving in severe conditions.

G030B01O-AAT

### Recommended Oil

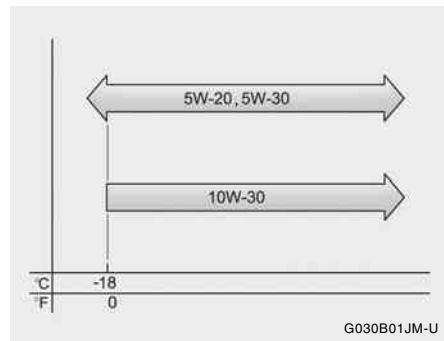

The engine oil quality should meet the following classification.

API SJ, SL or ABOVE,  
ILSAC GF-3 or ABOVE

### NOTE:

- o For good fuel economy, SAE 5W-20 (5W-30), ILSAC GF-3 engine oil is preferred regardless of regional option and engine variation.
- o If SAE 5W-20, ILSAC GF-3 engine oil is not available, secondary recommended engine oil for corresponding temperature range can be used.

G030C01JM-AAT

### To Check the Oil Level

(2.4L)

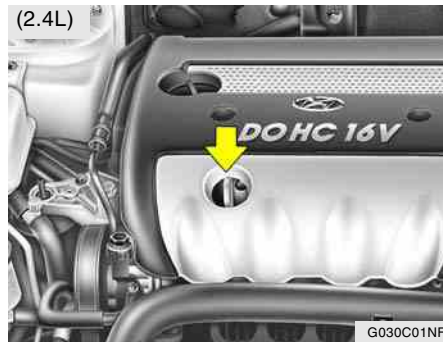

(3.3L)

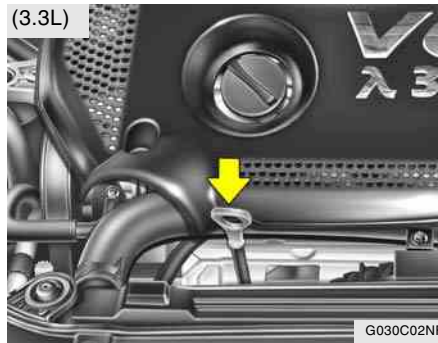

Before checking the oil, warm up the engine to the normal operating temperature and be sure your car is parked on level ground. Turn the engine off.

Wait five minutes, then remove the dipstick, wipe it off, fully reinsert the dipstick and withdraw it again. Then note the highest level the oil has reached on the dipstick. It should be between the upper ("F") and lower ("L") range.



### WARNING:

Be very careful not to touch the radiator hose when checking the engine oil as it may be hot enough to burn you.

G030D01O-AAT

**Adding Oil**

(2.4L)

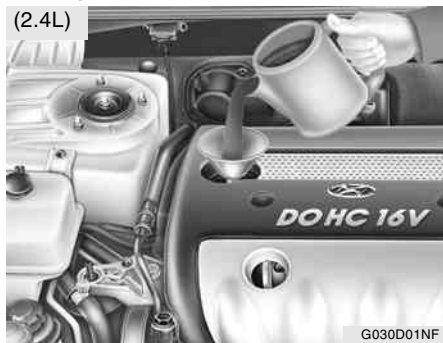

G030D01NF

(3.3L)

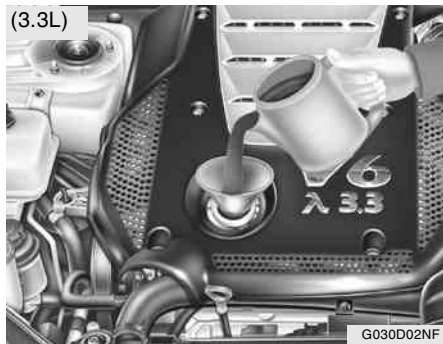

G030D02NF

If the oil level is close to or below the "L" mark, add oil until it reaches the "F" mark. To add oil:

1. Remove the oil filler cap by turning it counter-clockwise.
2. Add oil, then check the level again. Do not overfill.
3. Replace the cap by turning it clockwise.

The distance between the "F" and "L" marks is equal to about 1 quart of oil.

**CAUTION:**

Slowly pour the recommended oil into a funnel. Do not overfill to avoid damage to the engine.

**WARNING:**

Be very careful not to touch the radiator hose when adding the engine oil as it may be hot enough to burn you.

**CHANGING THE ENGINE OIL AND FILTER**

G040A01NF-AAT

(2.4L)

Oil filler cap



HNF5005

(3.3L)

Oil filter

Oil filler cap

Oil level dipstick



G040A01NF

The engine oil and filter should be changed at those intervals specified in the maintenance schedule in Section 5. If the car is being driven in severe conditions, more frequent oil and filter changes are required.

The procedure for changing the oil and filter is as follows:

1. Park the car on level ground and set the parking brake. Start the engine and let it warm up until the needle on the coolant temperature gauge moves above the lowest mark. Turn the engine off and place the gear selector lever in "P" (automatic) or reverse gear (manual transaxle).
2. Open the hood and remove the engine oil filler cap.

**NOTE:**

Loosen the oil filter cap by turning it counterclockwise to drain well the oil in the oil filter (3.3L only).

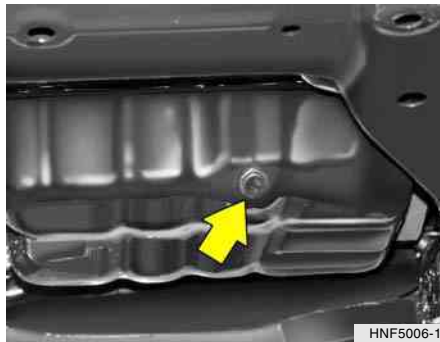

3. Slide underneath the car and loosen the drain plug by turning it counterclockwise with a wrench of the proper size. Be sure that a drain pan is in position to catch the oil as it drains out, then remove the drain plug.

**! WARNING:**  
Be very careful when draining the engine oil as it may be hot enough to burn you!

4. When the oil has stopped draining, replace the drain plug using a new gasket and re-tighten by turning it clockwise.

**Oil pan drain plug tightening torque:**  
25.3 ~ 32.5 lb.ft (3.5 ~ 4.5 kgf.m)

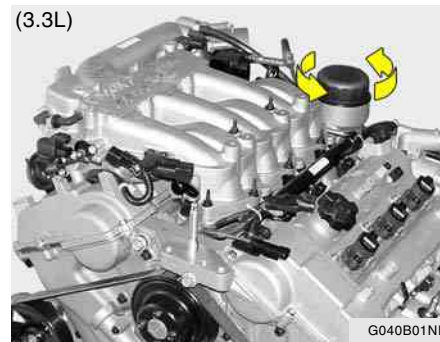
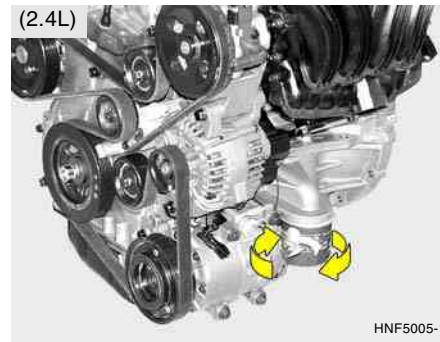

5. Remove the oil filter by turning it counter-clockwise with a oil filter wrench of the proper size. A certain amount of oil will come out when you remove the filter. So be sure to have your drain pan in place underneath it.
6. Install a new oil filter in accordance with the instructions on the carton or on the filter itself. Do not over-tighten.

**Tightening torque:**  
8.7 ~ 11.6 lb.ft (1.2 ~ 1.6 kgf.m)

Be sure that the mounting surface on the engine is clean and that the old gasket is removed completely. Lubricate the new gasket on the filter with clean engine oil before installation.

7. Remove the engine oil level dipstick.
8. Refill the crankcase with the recommended engine oil. Refer to the specification in chapter 9 for engine oil capacity.



**CAUTION:**

Slowly pour the recommended oil into a funnel. Do not overfill to avoid damage to the engine.

9. Start the engine and check to be sure no oil is leaking from the drain plug or oil filter.
10. Shut off the engine and recheck the oil level.

**NOTE:**

Always dispose of used engine oil in an environmentally acceptable manner. It is suggested that it be placed in a sealed container and taken to a service station for reclamation. Do not pour the oil on the ground or put it into the household trash.



**PROPOSITION 65 WARNING:**

Used engine oil may cause irritation or cancer of the skin if left in contact with the skin for prolonged periods of time. Used engine oil contains chemicals that have caused cancer in laboratory animals. Always protect your skin by washing your hands thoroughly with soap and warm water as soon as possible after handling used oil.

**CHECKING AND CHANGING THE ENGINE COOLANT**

G050A01A-AAT



**WARNING:**

Do not remove the radiator cap when the engine is hot. When the engine is hot, the engine coolant is under pressure and may erupt through the opening if the cap is removed. You could be seriously burned if you do not observe this precaution. Do not remove the radiator cap until the radiator is cool to the touch.

G050B01A-AAT

## Recommended Engine Coolant

Use a high quality ethylene-glycol coolant in a 50/50 mix with water. The engine coolant should be compatible with aluminum engine parts. Additional corrosion inhibitors or additives should not be used. The cooling system must be maintained with the correct concentration and type of engine coolant to prevent freezing and corrosion. Never allow the concentration of antifreeze to exceed the 60% level or go below the 35% level, or damage to the cooling system may result. For proper concentration when adding or replacing the engine coolant, refer to the following table.

Ambient temperature °F (°C)	Engine Coolant concentration	
	Antifreeze solution	Water
5 (-15)	35%	65%
-13 (-25)	40%	60%
-31 (-35)	50%	50%
-49 (-45)	60%	40%

G050C01NF-GAT

## To Check the Coolant Level

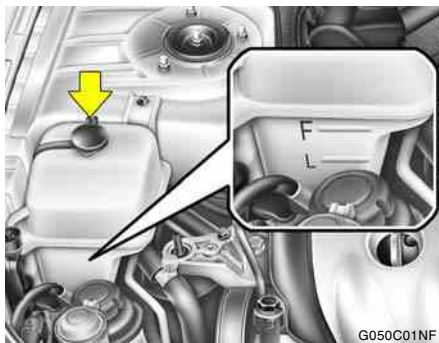

The coolant level can be seen on the side of the plastic coolant reservoir. The level of the coolant should be between the "L" and "F" lines on the reservoir when the engine is warm with it at idle. If the level is below the "L" mark, add engine coolant to bring it up to "F". If the level is low, inspect for coolant leaks and recheck the fluid level frequently. If the level drops again, visit your Hyundai dealer for an inspection and diagnosis of the reason.

G050D01NF-GAT

## To Change the Engine Coolant

The engine coolant should be changed at those intervals specified in the vehicle maintenance schedule in Section 5.



### CAUTION:

- o Engine coolant can damage the finish of your car. If you spill engine coolant on the car, wash it off thoroughly with clean water.
- o The engine in your vehicle has aluminum engine parts and must be protected by an ethylene-glycol base coolant to prevent corrosion and freezing. Do not use hard water. Hard water can cause engine damage from corrosion, overheating or freezing.

1. Park the car on level ground, set the parking brake and remove the radiator cap when cool.

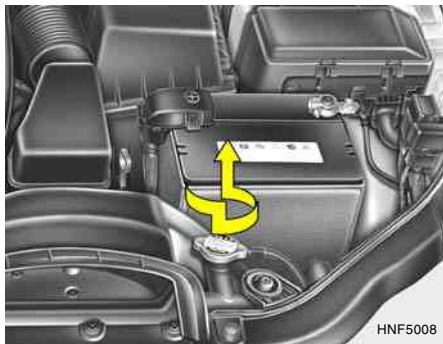

2. Wrap a thick cloth around the radiator cap and slowly turn the radiator cap counterclockwise without pressing down on it, until it stops. This relieves any pressure remaining in the cooling system. When you are sure that all the pressure has been released, remove the radiator cap by pushing down and turning counterclockwise.
3. Be sure your drain receptacle is in place. Open the drain cock on the radiator. Allow all the engine coolant to drain from the cooling system, and then securely close the drain cock.
4. Check Section 9 for the capacity of the cooling system in your car. Then, following the manufacturer's directions on the engine coolant container, add the appropriate quantity of coolant to the radiator.
5. Slowly fill the radiator with the proper coolant mixture (see the "Recommended Engine Coolant in previous page) until the fluid level stays up in the radiator neck. And pump the radiator hose in order to bleed the air.
6. Run the engine at idle until the coolant circulates. If the cooling fan operates and the coolant starts to circulate, add the coolant to the reservoir.
7. To bleed the air in the cooling system, repeat procedure 6 until the cooling fan operates 3-5 times.
8. Replace the radiator cap and turn it until tightly installed. And then, add coolant to the reservoir until the level is between "L" and "F".
9. Stop the engine and check the coolant level when the engine is cool. The level of the coolant should be the "L" and "F" lines on the reservoir. If the level is below the "L" line, repeat the procedure 4-8 until the level between "L" and "F".



## SPARK PLUGS

10. Replace the reservoir cap and check to be sure the drain cock and the radiator cap are fully closed and not leaking.

**CAUTION:**

Recheck after a few days and add the coolant if the level is below the "L" level.

**WARNING:**

The cooling fan is controlled by engine coolant temperature and may sometimes operate even when the engine is not running. Use extreme caution when working near the blades of the coolant fan so that you are not injured by a rotating fan blade. As the engine coolant temperature decreases, the fan will automatically shut off. This is a normal condition.

G060A01NF-AAT

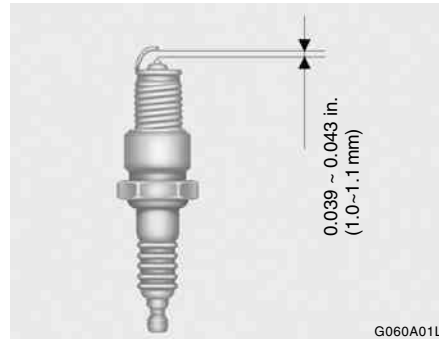

G060A01L

Your engine was originally equipped with Iridium-tipped spark plugs. Iridium-tipped spark plugs will last longer than conventional type spark plugs and can be identified by blue lines on the ceramic shell.

**NOTE:**

Do not clean or regap Iridium-tipped spark plugs.

G060B01NF-AAT

**Replacing the Spark Plugs**

The spark plugs should be changed at the intervals specified in the vehicle maintenance schedule in Section 5 or whenever engine performance indicates they should be changed. Symptoms that suggest poor spark plug performance include engine misfiring under load, loss of fuel economy, poor acceleration, etc. When spark plugs are replaced, always use spark plugs recommended by Hyundai. The use of other spark plugs can result in loss of performance, radio interference or engine damage.

**NOTE:**

When replacing the spark plugs, always use the genuine parts recommended.

**Recommended Spark Plugs:**

Type	Remark
SK16PR-A11	2.4L
IFR5G-11	3.3L

G060C01NF-GAT

## Changing the Spark Plugs

You will find it easier to change spark plugs if the engine is cold. Always change one spark plug at a time. This helps avoid getting the wires mixed up.

1. Remove the engine cover.

### NOTE:

**It is recommended that the spark plugs for 3.3L engines be changed by an authorized Hyundai dealer.**

2. Using a clean cloth, remove any dirt that has accumulated around the base of the spark plug so it cannot fall into the cylinder when the spark plug is removed.

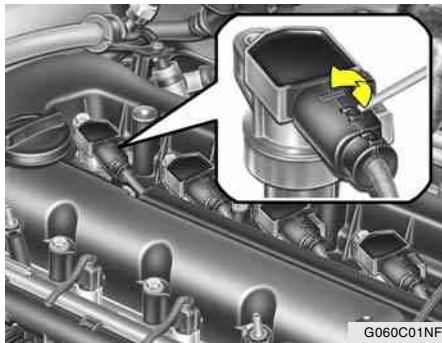

3. Remove the cover of the ignition connector with a flat-head screwdriver.

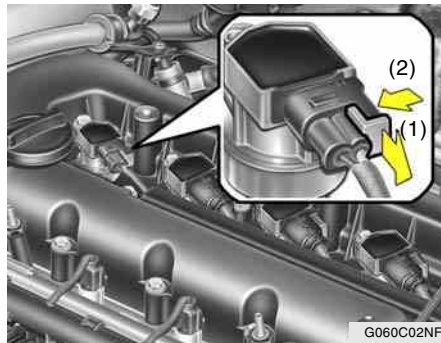

4. Pull the ignition connector key in the direction of (1).
5. Press the position (2) of the ignition connector key and detach the ignition connector by pulling it.

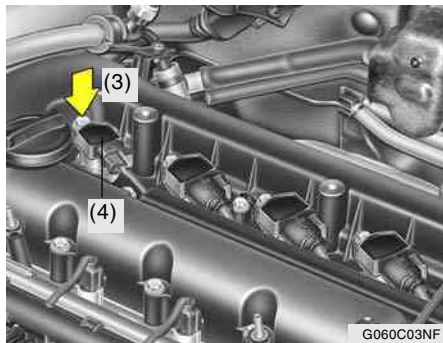

6. Remove the mounting bolt (3) of the ignition coil with a socket wrench.
7. Pull straight up on the ignition coil (4).

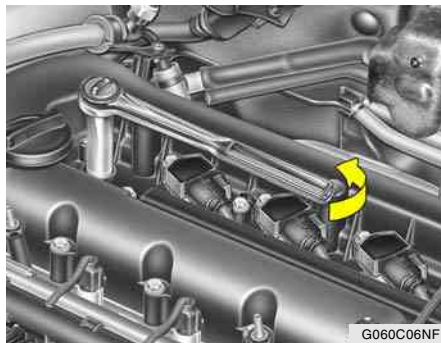

**!** **WARNING:**  
 It is recommended that the engine be cool or cold when changing the spark plugs. If the engine is hot, you could burn yourself on the insulated connector, the spark plug or the engine itself.

8. When preparing to remove the spark plug, guide the socket down over the spark plug, being careful not to damage the ceramic insulator.
9. To remove the spark plug, turn the wrench handle in a counterclockwise direction.

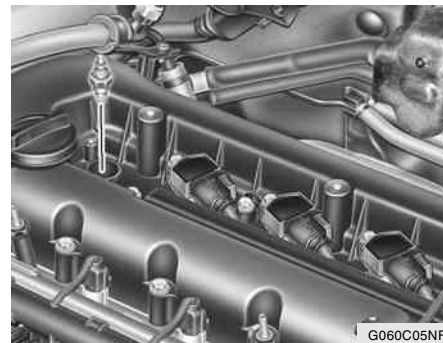

10. To install the new spark plug, guide the socket down over the spark plug, being careful not to damage the ceramic insulator.

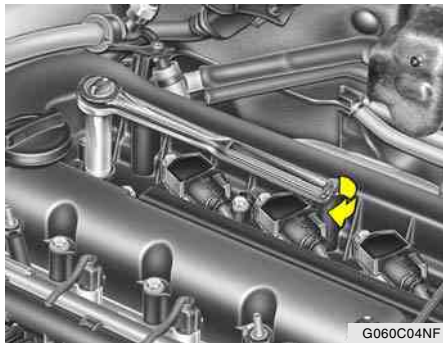

11. Installation is the reverse order of disassembly.

**NOTE:**

Spark plugs should be tightened firmly. (Tightening torque: 18.0 lb.ft (2.5 kgf.m)) Over-tightening can damage the threads in the aluminum cylinder head. Also, leaving them too loose can cause the spark plug to get very hot and possibly result in damage to the engine.

## CHANGING THE AIR CLEANER FILTER

G070A03Y-AAT

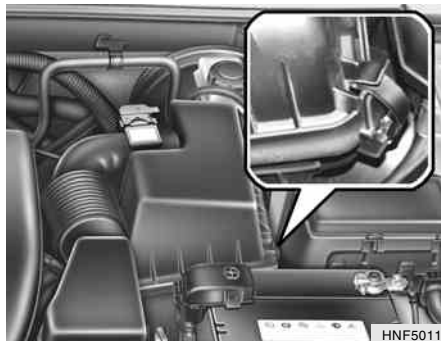

The replacement of the air cleaner filter is performed in the following manner.

1. Unsnap the clips around the cover.
2. When this is done, the cover can be lifted off, the old filter removed and the new filter put in its place.

Genuine Hyundai replacement parts are recommended.



**CAUTION:**

- o Operating your vehicle without using a proper air cleaner filter in place can result in excessive engine wear.
- o When removing the air cleaner filter, be careful that dust or dirt does not enter the air intake. These may result in damage to the air cleaner filter.

## WINDSHIELD WIPER BLADES

G080A02A-AAT



The wiper blades should be carefully inspected from time to time and cleaned to remove accumulations of road film or other debris. To clean the wiper blades and arms, use a clean sponge or cloth with a mild soap or detergent and water. If the wipers continue to streak or smear the glass, replace them with genuine Hyundai replacement parts or their equivalent.

**CAUTION:**

- o Do not operate the wipers on dry glass. This can result in more rapid wear of the wiper blades and may scratch the glass.
- o Keep the blade rubber out of contact with petroleum products such as engine oil, gasoline, etc.

G080B01HR-GAT

**Replacing the Wiper Blades**

To replace the wiper blades, raise the wiper to the vertical position.

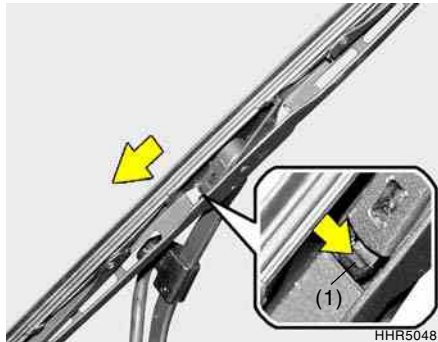
**To remove the wiper blade**

1. Push down the wiper blade with the locking clip (1) pressed to detach it from the wiper arm.

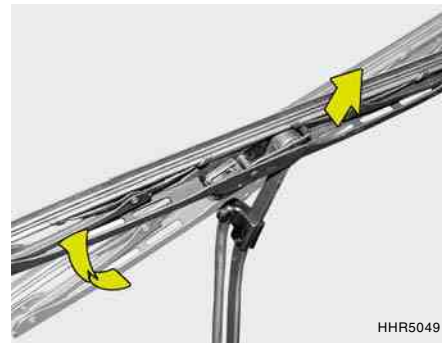

2. Raise the wiper blade lightly and pull it up.

### To install the wiper blade

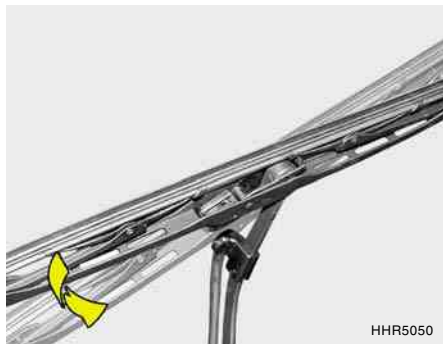

1. Put a new wiper blade onto the wiper arm and lower the wiper blade at the level of the wiper arm as shown in the drawing.

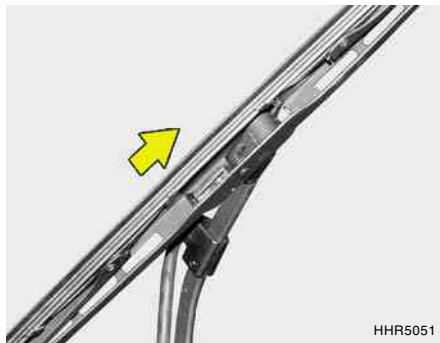

2. Pull up the wiper blade until you hear an audible "click" to engage in the end of the wiper arm.

#### NOTE:

**Do not allow the wiper arm to fall against the windshield.**

### FILLING THE WASHER RESERVOIR

G090A02NF-AAT

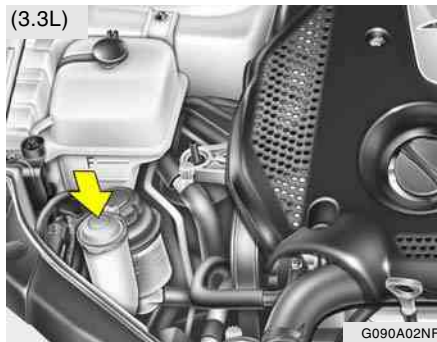
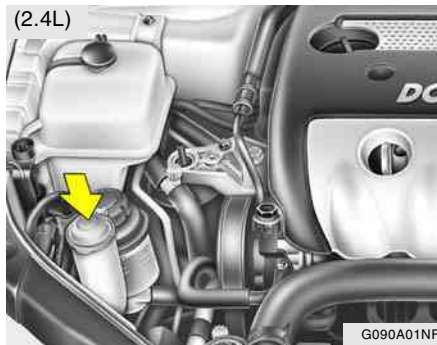

The washer fluid reservoir supplies fluid to the windshield washer system.

A good quality washer fluid should be used to fill the washer reservoir. The fluid level should be checked more frequently during bad weather or whenever the washer system is in more frequent use.

The capacity of the washer reservoir is 3.2 U.S. quarts (4.0 liters).



#### CAUTION:

- o Radiator antifreeze (engine coolant) should not be used in the washer system because it will damage the car's finish.
- o The washer lever should not be pulled and the washer should not be operated if the washer reservoir is empty. This can damage the washer fluid pump.



#### WARNING:

- o Windshield washer fluid agents contain some amounts of alcohol and can be flammable under certain circumstances. Do not allow sparks or flame to contact the washer fluid or the washer fluid reservoir. Damage to the vehicle or its occupants could occur.
- o Windshield washer fluid is poisonous to humans and animals. Do not drink windshield washer fluid. Serious injury or death could occur.

## CHECKING THE TRANSAXLE OIL (MANUAL)

G100A01NF-AAT

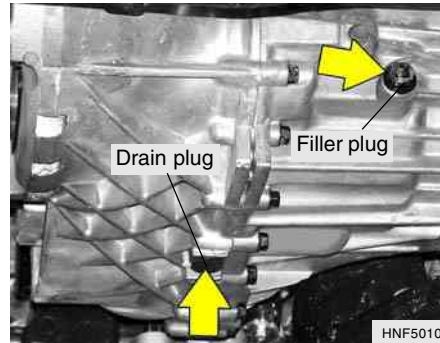

Transaxle lubricant in the manual transaxle should be checked at those intervals specified in the vehicle maintenance schedule in Section 5.

### Recommended Oil

Use only HYUNDAI GENUINE PARTS MTF 75W/85 (API GL-4) in the manual transaxle.

### Manual Transaxle Oil Capacity

The oil capacity of the manual transaxle is 2.0 U.S. quarts (1.9 liters).



#### WARNING:

It is always better to check the transaxle oil level when the engine is cool or cold. If the engine is hot, you should exercise great caution to avoid burning yourself on hot engine or exhaust parts.

G100B02A-AAT

### To Check the Manual Transaxle Fluid Level

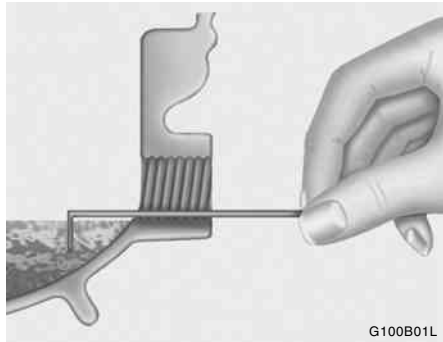

Park the car on level ground with the engine off.

1. Using a wrench of the correct size, loosen the oil filler plug by turning it counterclockwise and remove it with your fingers.
2. Use your finger to feel inside the hole. The oil level should be at its bottom edge. If it is not, check for leaks before adding oil. To refill the transaxle or bring the oil level up, add oil slowly until it reaches the proper level. Do not overfill.
3. Replace the plug and washer, screw it in with your fingers and then tighten securely with the wrench.

### CHECKING THE TRANSAXLE FLUID (AUTOMATIC)

G110A01E-AAT

Transaxle fluid in the automatic transaxle should be checked at those intervals specified in the vehicle maintenance schedule in Section 5.

#### NOTE:

**Automatic transaxle fluid is basically red in color. As driving distance increases, the fluid color turns darkish red gradually. It is a normal condition and you should not judge the need to replace based upon the changing color.**

**You must replace the automatic transaxle fluid in accordance with intervals specified in the vehicle maintenance schedule in section 5.**

G110B05A-AAT

### Recommended Fluid

Your Hyundai automatic transaxle is specially designed to operate with HYUNDAI GENUINE ATF SP III, DIAMOND ATF SP III, SK ATF SP III or other brands meeting the SP III specification approved by Hyundai Motor Co.. Damage caused by a nonspecified fluid is not covered by your new vehicle limited warranty.



#### CAUTION:

**Use of aftermarket ATF additives may cause damage to the automatic transaxle. Only use HYUNDAI GENUINE ATF SP III, DIAMOND ATF SP III, SK ATF SP III or other brands meeting the SP III specification approved by Hyundai Motor Co.. If you are having your vehicle serviced at a facility other than a Hyundai dealer, verify that the correct ATF is used for your vehicle.**



G110C01NF-AAT

**Transaxle Fluid Capacity**

The fluid capacity of the automatic transaxle is:

2.4L	8.24 U.S. quarts (7.8 liters)
3.3L	11.52 U.S. quarts (10.9 liters)

**WARNING:**

The transaxle fluid level should be checked when the engine is at normal operating temperature. This means that the engine, radiator, radiator hose, exhaust system etc., are very hot. Exercise great care not to burn yourself during this procedure.

G110D02O-AAT

**To Check the Transaxle Fluid Level**

Park the car on level ground with the parking brake engaged. When the transaxle fluid level is checked, the transaxle fluid should be at normal operating temperature and the engine idling.



While the engine is idling, apply the brakes and move the gear selector lever from "P" to each of its other positions — "R", "N", "D" — and then return to "N" or "P". With the engine still idling:

1. Open the hood, being careful to keep hands, long hair and clothing clear of any moving parts.



2. Remove the transaxle dipstick, wipe it clean, reinsert the dipstick as far as it will go, then remove it again. Now check the fluid level on the dipstick. It should be in the "HOT" range on the dipstick.

## CHECKING THE BRAKES

G120A01A-AAT

**CAUTION:**

Because brakes are essential to the safe operation of the car, it is suggested that they be checked and inspected by your Hyundai dealer. The brakes should be checked and inspected for wear at those intervals specified in the vehicle maintenance schedule in Section 5.

G120C02A-AAT

**Recommended Brake Fluid**

Use only hydraulic brake fluid conforming to DOT 3 or DOT 4 specifications in your braking system. Follow the instructions printed on the container.

G120D01A-AAT

**To Check the Fluid Level**

The fluid level in the brake fluid reservoir should be checked periodically. The level should be between the "MIN" and "MAX" marks on the side of the reservoir. If the level is at or below the "MIN" mark, carefully add fluid to bring it up to "MAX". Do not overfill.

Fluid level should be within "HOT" range



G110D02NF

- If the transaxle fluid level is low, use a funnel to add transaxle fluid through the dipstick tube until the level reaches the "HOT" range. Do not overfill.

**WARNING:**

The cooling fan is controlled by engine coolant temperature and may sometimes operate even when the engine is not running. Use extreme caution when working near the blades of the cooling fan so that you are not injured by a rotating fan blade. As the engine coolant temperature decreases, the fan will automatically shut off. This is a normal condition.

G120B01A-AAT

**WARNING:**

Use caution when handling brake fluid. It can damage your vision if it gets into your eyes. It will also damage your vehicle's paint if spilled on it and not removed immediately.

**Checking the Brake Fluid Level**

## AIR CONDITIONING CARE

G120E02A-AAT

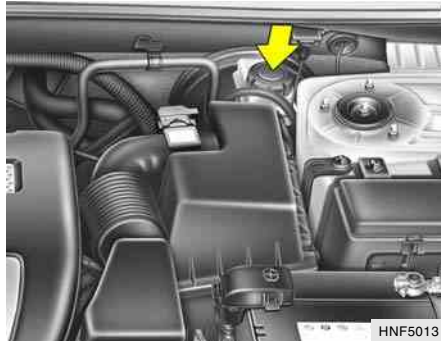
**Adding Brake Fluid****WARNING:**

Handle brake fluid carefully. It can damage your vision if it gets into your eyes. Use only DOT 3 or DOT 4 specification fluid from a sealed container. Do not allow the fluid can or reservoir to remain open any longer than required. This will prevent entry of dirt and moisture which can damage the brake system and cause improper operation.

To add brake fluid, first wipe away any dirt then unscrew the fluid reservoir cap. Slowly pour the recommended fluid into the reservoir. Do not overfill. Carefully replace the cap on the reservoir and tighten.

G140A01A-AAT

**Keeping the Condenser Clean**

The air conditioning condenser (and engine radiator) should be checked periodically for accumulation of dirt, dead insects, leaves, etc. These can interfere with maximum cooling efficiency. When removing such accumulations, brush or hose them away carefully to avoid bending the cooling fans.

G140B01A-AAT

**Checking the Air Conditioning Operation**

1. Start the engine and let it run at a fast idle for several minutes with the air conditioning set at the maximum cold setting.
2. If the air coming out of the in-dash vents is not cold, have the air conditioning system inspected by your Hyundai dealer.

**CAUTION:**

Running the air conditioning system for extended periods of time with a low refrigerant level may damage the compressor.

G140C01A-AAT

**Lubrication**

To lubricate the compressor and the seals in the system, the air conditioning should be run for at least 10 minutes each week. This is particularly important during cool weather when the air conditioning system is not otherwise in use.

## CHANGING THE AIR CONDITIONER FILTER

B145A01NF-AAT

### (For Evaporator and Blower Unit) (If Installed)

The air conditioner filter is located in the right side of the instrument panel. It helps to decrease the amount of pollutants entering the car.

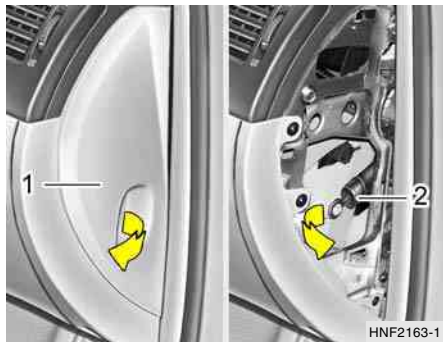

1. Remove the cover (1) which is located to the right side of the instrument panel by pulling it.
2. Pull the glove box cylinder (2) to unlock the glove box retainer.

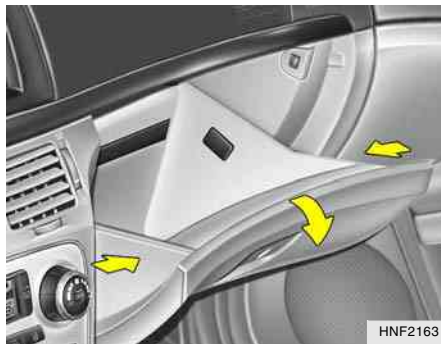

3. Lower the glove box down completely by pushing both sides of the glove box inward.

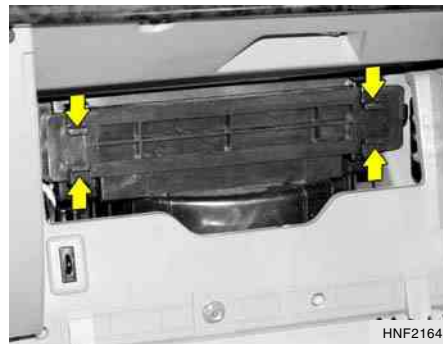

4. Remove the air conditioner filter cover by pressing both side clips.



**CAUTION:**  
Be careful not to damage filter fixing clips.

## CHECKING THE FREE-PLAY

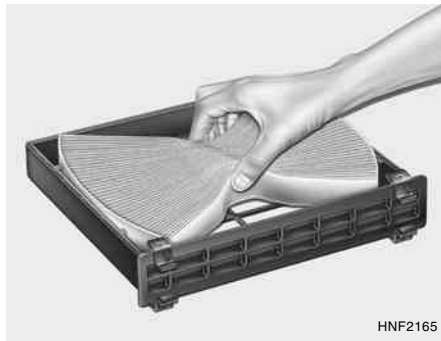

HNF2165

5. Replace the air conditioner filter by lifting it.
6. Installation is the reverse order of disassembly.

**CAUTION:**

To prevent pollutants from entering the car, be sure to properly install the air conditioner filter.

G150A01A-AAT

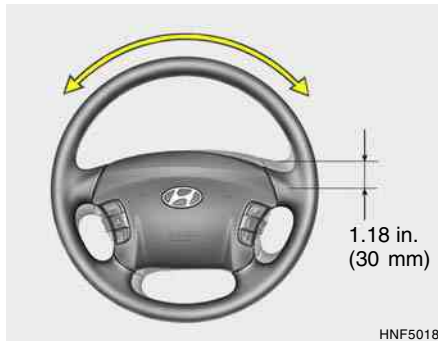
**STEERING WHEEL**

HNF5018

To check the steering wheel free-play, stop the car with the wheels pointed straight ahead and gently move the steering wheel back and forth. Use very light finger pressure and be sensitive to changes in resistance that mark the limits of the free-play. If the free-play is greater than specified, have it inspected by your Hyundai dealer and adjusted or repaired if necessary.

G160A01A-GAT

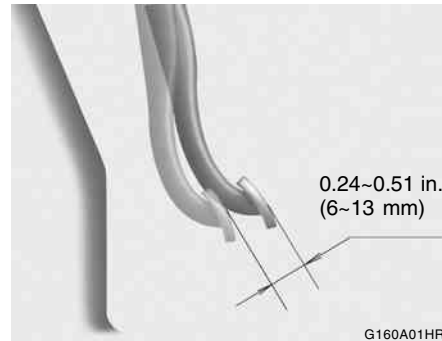
**CLUTCH PEDAL**

G160A01HR

With the engine off, press lightly on the clutch pedal until you feel a change in resistance. This is the clutch pedal free-play. The free-play should be within the limits specified in the illustration. If it is not, have it inspected by your Hyundai dealer and adjusted or repaired if necessary.

G170A01A-AAT

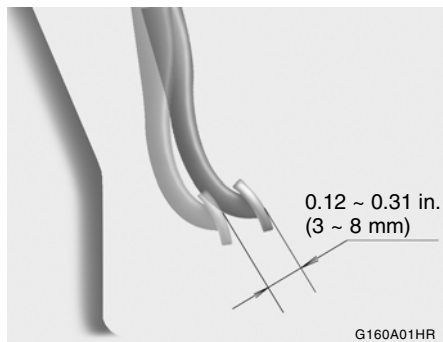
**BRAKE PEDAL**

With the engine off, press down on the brake pedal several times to reduce the vacuum in the brake booster.

Then, using your hand, press down slowly on the brake pedal until you feel a change in resistance. This is the brake pedal free-play. The free-play should be within the limits specified in the illustration above. If it is not, have it inspected by your Hyundai dealer and adjusted or repaired if necessary.

**CHECKING BRAKE PEDAL CLEARANCE**

G180A01A-AAT

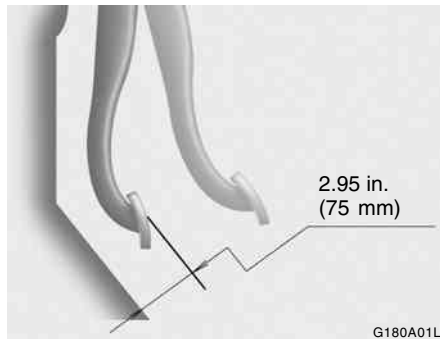

You need a helper to check the brake pedal clearance. With the engine running, have your helper press down on the brake pedal several times and then hold it down with a force of about 110 lbs (50 kg, 490 N). The brake pedal clearance is the distance from the top surface of the brake pedal to the asphalt sheeting under the floor mat.

If the brake pedal clearance is not within the limits specified in the illustration, have it inspected by your Hyundai dealer and adjusted or repaired if necessary.

**CHECKING DRIVE BELTS**

G190A02NF-GAT

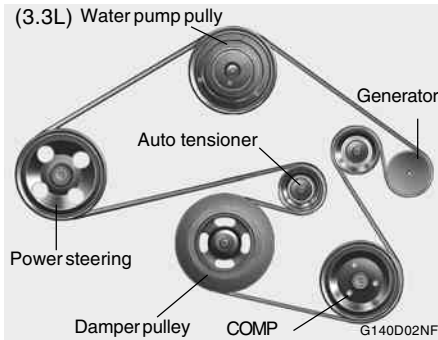
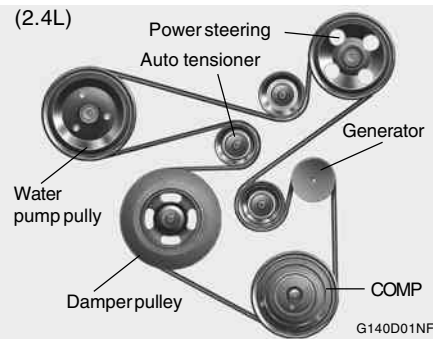

## CHECKING AND REPLACING FUSES

G200A01A-AAT

### Replacing a Fusible Link



A fusible link will melt if the electrical circuits from the battery are ever overloaded, thus preventing damage to the entire wiring harness. (This could be caused by a short in the system drawing too much current.) If this ever happens, have a Hyundai dealer determine the cause, repair the system and replace the fusible link. The fusible links are located in a relay box in the engine compartment for easy inspection.



#### CAUTION:

When replacing a fusible link, never use anything but a new fusible link with the same or lower amperage rating. Never use a piece of wire or a higher-rated fusible link. This could result in serious damage and create a fire hazard.

Drive belts should be checked periodically for proper tension. At the same time, belts should be examined for cracks, wear, fraying or other evidence of deterioration and replaced if necessary.

When a new belt is replaced, the belt should be located within the pulley of flat idler.

Belt routing should also be checked to be sure there is no interference between the belts and other parts of the engine.

#### NOTE:

Drive belt tension is adjusted automatically by the auto tensioner.

G200B01NF-GAT

**Replacing Accessory Fuse**

G200B01NF-A

The fuse box for the lights and other electrical accessories will be found on the left side of the instrument panel. Inside the box you will find a list showing the circuits protected by each fuse. If any of your car's lights or other electrical accessories stop working, a blown fuse could be the reason. If the fuse has burned out, you will see that the metal strip inside the fuse has burned through. If you suspect a blown fuse, follow this procedure:

1. Turn off the ignition and all other switches.

2. Open the fuse box and examine each fuse. Remove each fuse by pulling it toward you (a small "fuse puller" tool is contained in the relay and fuse box of the engine room to simplify this operation).
3. Be sure to check all other fuses even if you



G200B02NF

find one that appears to have burned out.

4. Replace the blown fuse by pressing a new fuse of the same rating into place. The fuse should be a snug fit. If it is not, have the fuse clip repaired or replaced by a Hyundai dealer. If you do not have a spare fuse, you may be able to borrow a fuse of the same or lower rating from an accessory you can temporarily get along without (the radio or cigarette lighter, for example). Always remember to replace the borrowed fuse.

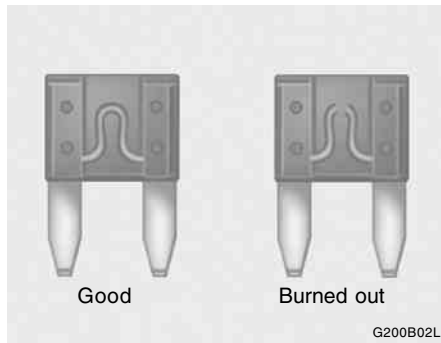

G200B02L

**CAUTION:**

A burned-out fuse indicates that there is a problem in the electrical circuit. If you replace a fuse and it blows as soon as the accessory is turned on, the problem is serious and should be referred to a Hyundai dealer for diagnosis and repair. Never replace a fuse with anything except a fuse with the same or a lower amperage rating. A higher capacity fuse could cause damage and create a fire hazard.

**NOTE:**

See page 6-39 for the fuse panel descriptions.



## CHECKING THE BATTERY

G210A01A-AAT

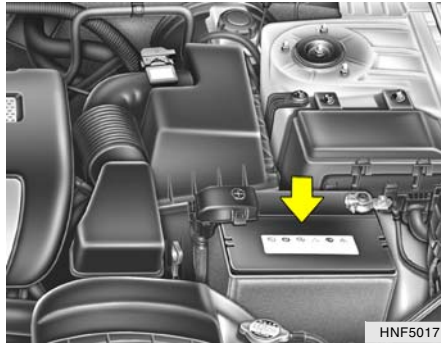
**WARNING:**

**Batteries can be dangerous! When working with batteries, carefully observe the following precautions to avoid serious injuries.**

The fluid in the battery contains a strong solution of sulfuric acid, which is poisonous and highly corrosive. Be careful not to spill it on yourself or the car. If you do spill battery fluid on yourself, immediately do the following:

- o If battery fluid is on your skin, flush the affected areas with water for at least 15 minutes and then seek medical assistance.
- o If battery fluid is in your eyes, rinse out your eyes with water and get medical assistance as soon as possible. While you are being driven to get medical assistance, continue to rinse your eyes by using a sponge or soft cloth saturated with water.
- o If you swallow battery fluid, drink a large quantity of water or milk followed by milk of magnesia, eat a raw egg or drink vegetable oil. Get medical assistance as soon as possible.

While batteries are being charged (either by a battery charger or by the vehicle's generator), they produce explosive gases. Always observe these warnings to prevent injuries from occurring:

- o Charge batteries only in a well ventilated area.
- o Do not permit flames, sparks or smoking in the area.
- o Keep children away from the area.

G210B04A-AAT

**Checking the Battery**

Keep the battery clean. Any evidence of corrosion around the battery posts or terminals should be removed using a solution of household baking soda and warm water. After the battery terminals are dry, cover them with a light coating of grease.

**PROPOSITION 65 WARNING:**

**Battery posts, terminals, and related accessories contain lead and lead compounds, chemicals known to the state of California to cause cancer and reproductive harm. Batteries also contain other chemicals known to the state of California to cause cancer. Wash hands after handling.**

**WARNING:**

Always read the following instructions carefully when handling a battery.



Keep lighted cigarettes and all other flames or sparks away from the battery.



Hydrogen, which is a highly combustible gas, is always present in battery cells and may explode if ignited.



Keep batteries out of the reach of children because batteries contain highly corrosive **SULFURIC ACID**. Do not allow battery acid to contact your skin, eyes, clothing or paint finish.



If any electrolyte gets into your eyes, flush your eyes with clean water for at least 15 minutes and get immediate medical attention. If possible, continue to apply water with a sponge or cloth until medical attention is received.

**WARNING:**

If electrolyte gets on your skin, thoroughly wash the contacted area.

If you feel a pain or a burning sensation, get medical attention immediately.



Wear eye protection when charging or working near a battery. Always provide ventilation when working in an enclosed space.

- o When lifting a plastic-cased battery, excessive pressure on the case may cause battery acid to leak, resulting in personal injury. Lift with a battery carrier or with your hands on opposite corners.
- o Never attempt to charge the battery when the battery cables are connected.
- o The electrical ignition system works with high voltage. Never touch these components with the engine running or the ignition switched on.

## CHECKING ELECTRIC COOLING FANS

G220A01A-AAT

**WARNING:**

The cooling fan is controlled by engine coolant temperature and may sometimes operate even when the engine is not running. Use extreme caution when working near the blades of the cooling fan, so that you are not injured by a rotating fan blade. As the engine coolant temperature decreases the fan will automatically shut off. This is a normal condition.

G220B01NF-GAT

### Checking Engine Cooling Fan

The engine cooling fan should come on automatically if the engine coolant temperature is high or whenever the air conditioning is in operation.

## POWER STEERING FLUID LEVEL

G230A03A-AAT

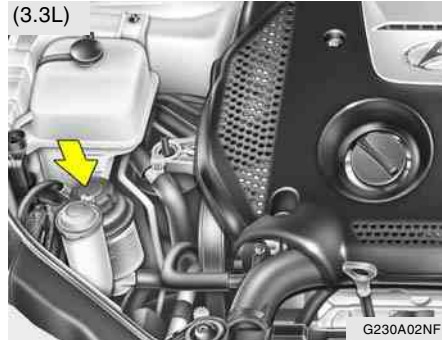
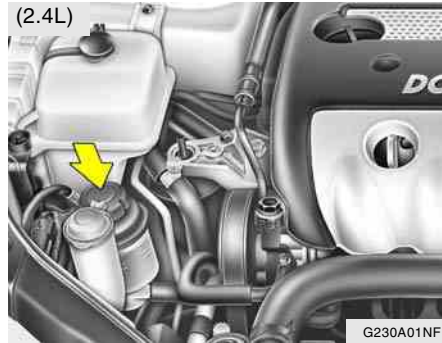

The power steering fluid level should be checked regularly. To check the power steering fluid level, be sure the engine is "OFF", then check

to make certain that the power steering fluid level is between the "MAX" and "MIN" level markings on the fluid reservoir.

**NOTE:**

**Grinding noise from the power steering pump may be heard immediately after the engine is started in extremely cold conditions (below - 4°F). If the noise stops during warm up, there is no abnormal function in the system. It is due to a power steering fluid characteristic in extremely cold conditions.**

**Recommended Fluid**

Use PSF-3 type fluid

**NOTE:**

**Do not start the engine when the power steering oil reservoir is empty.**

G240A01A-AAT

**POWER STEERING HOSES**

It is suggested that you check the power steering hose connections for fluid leakage at those intervals specified in the vehicle maintenance schedule in Section 5.

The power steering hoses should be replaced if there is severe surface cracking, pulling, scuffing or worn spots. Deterioration of the hose could cause premature failure.

**FOR MORE INFORMATION ABOUT YOUR HYUNDAI**

G250A01A-AAT

If you desire additional information about maintaining and servicing your Hyundai, you may purchase a factory Shop Manual at your Hyundai dealer's parts department. This is the same manual used by dealership technicians and while it is highly technical it can be useful in obtaining a better understanding of your car and how it works.

## HEADLIGHT AIMING ADJUSTMENT

G290A02O-AAT

Before performing aiming adjustment, make sure of the following.

1. Keep all tires inflated to the correct pressure.
2. Place the vehicle on level ground and press the front bumper & rear bumper down several times.  
Place vehicle at a distance of 118 in. (3m) from the test wall.
3. See that the vehicle is unloaded (except for full levels of coolant, engine oil and fuel, and spare tire, jack, and tools). Have the driver or equivalent weight placed in driver's seat.
4. Clean the headlight lenses and turn on the headlights (Low beam).
5. Open the hood.

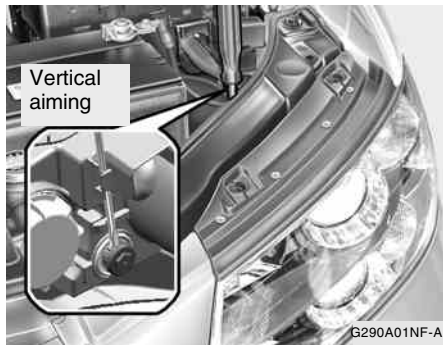

6. Draw a vertical line (through the center of each headlight beam pattern) and a horizontal line (through the center of each headlight beam pattern) on the aiming screen. And then, draw a parallel line at 0.8 in. (21 mm) under the horizontal line.
7. Adjust each cut-off line of the low beam to the parallel line with a phillips screwdriver - VERTICAL AIMING.

**WARNING:**  
Horizontal aiming should be adjusted by an authorized Hyundai dealer.

G290B01NF-AAT

## Adjustment After Headlight Assembly Replacement

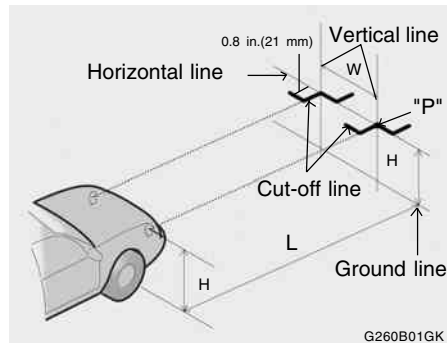

If the vehicle has had front body repair and the headlight assembly has been replaced, the headlight aiming should be checked using the aiming screen as shown in the illustration. Turn on the headlight switch (Low Beam Position).

1. Adjust headlights so that main axis of light is parallel to the center line of the body and is aligned with point "P" shown in the illustration.
2. Dotted lines in the illustration show the center of the headlights.

## REPLACEMENT OF LIGHT BULBS

## SPECIFICATION:

"H"

Horizontal center line of headlights from ground : 26.73 in. (679mm)

"W"

Distance between each headlight center : 51.41 in. (1,306mm)

"L"

Distance between the headlights and the wall that the lights are tested against : 118.11 in. (3,000 mm)

G260A01L-GAT

Before attempting to replace a light bulb, be sure the switch is turned to the "OFF" position.

The next paragraph shows how to reach the light bulbs so they may be changed. Be sure to replace the burned-out bulb with one of the same number and wattage rating.

See page 6-38 for the wattage descriptions.

**CAUTION:**

- o Keep the lights out of contact with petroleum products, such as oil, gasoline, etc.
- o Be sure to replace the LED type equipped bulbs with an assembly.

G270A01NF-AAT

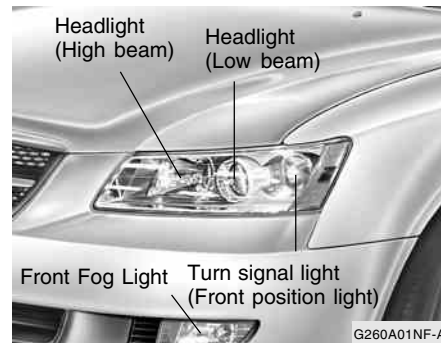
**HEADLIGHT, FRONT TURN SIGNAL LIGHT AND FRONT FOG LIGHT****► Headlight and Front Turn Signal Light**

Replacement instructions:

1. Allow the bulb to cool. Wear eye protection.
2. Open the engine hood.
3. Always grasp the bulb by its plastic base, avoid touching the glass.

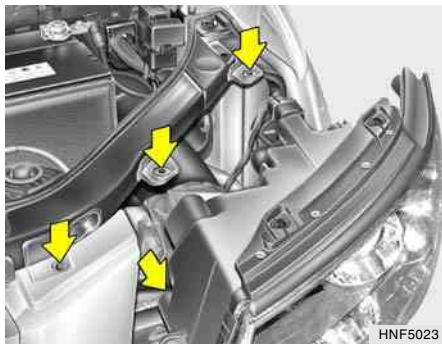

HNF5023

4. Using a socket wrench of the correct size, remove the headlight assembly mounting bolts.

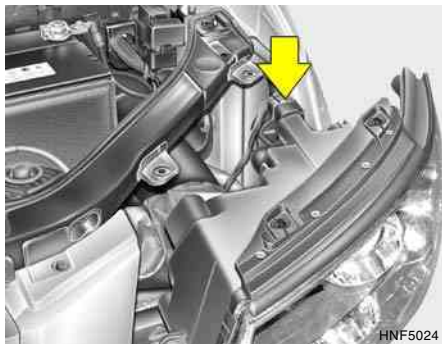

HNF5024

5. Disconnect the power cord from the back of the headlight.

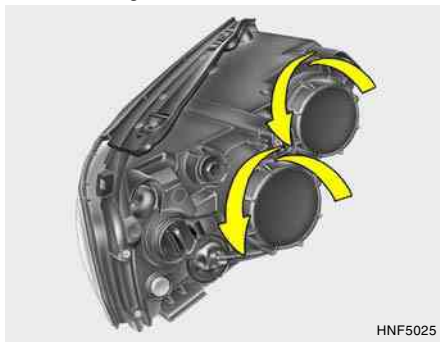

HNF5025

6. Turn the plastic cover counterclockwise and remove it.

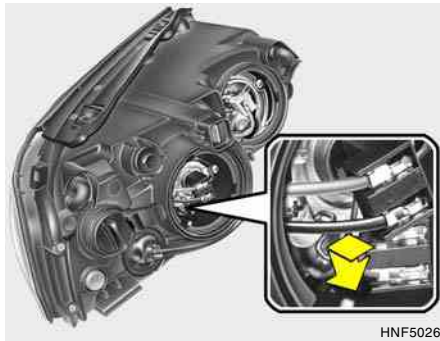

HNF5026

7. Disconnect the connector from the bulb base in the back of the headlight.  
8. Push the bulb spring to remove the headlight bulb.

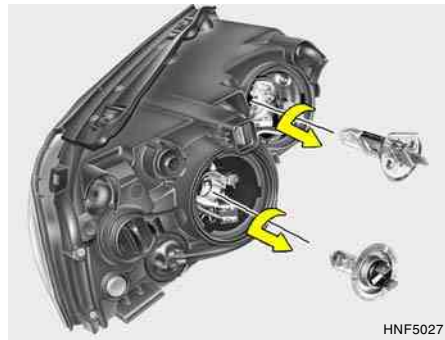

HNF5027

9. Remove the protective cap from the replacement bulb and install the new bulb by matching the plastic base with the headlight hole. Reattach the bulb spring and reconnect the connector.  
10. Use the protective cap and carton to promptly dispose of the old bulb.  
11. Check for proper headlight aim.

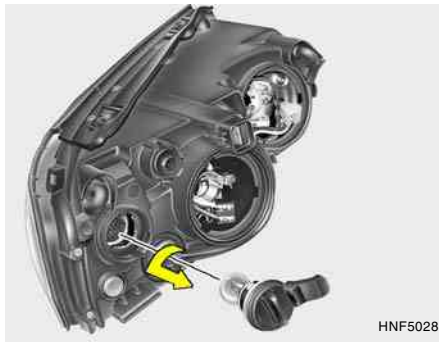

HNF5028

12. To replace the front turn signal light bulb (front position light), remove it from the bulb holder and install the new bulb.



G270A030

**!** **WARNING:**  
 This halogen bulb contains gas under pressure and if impacted could shatter, resulting in flying fragments. Always wear eye protection when servicing the bulb. Protect the bulb against abrasions or scratches and against liquids when lighted. Turn the bulb on only when installing in a headlight. Replace the headlight if damaged or cracked. Keep the bulb out of the reach of children and dispose of the used bulb with care.

► **Front Fog Light**

**NOTE:**

It is recommended that the front fog light bulb should be replaced by an authorized Hyundai dealer.

G270D01NF-AAT

**REAR COMBINATION LIGHT**

► **Stop/Tail Light, Rear Turn Signal Light, Back-up Light and Rear Side Marker Light**

1. Open the trunk lid.

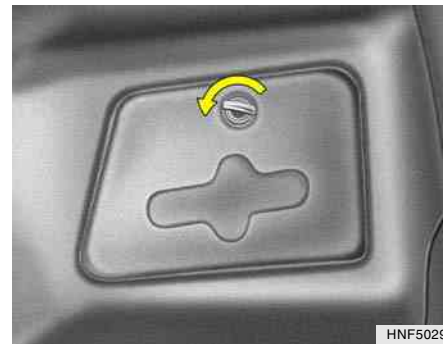

HNF5029

2. Remove the cover on the inside of the rear luggage trim by turning the knob counter-clockwise.

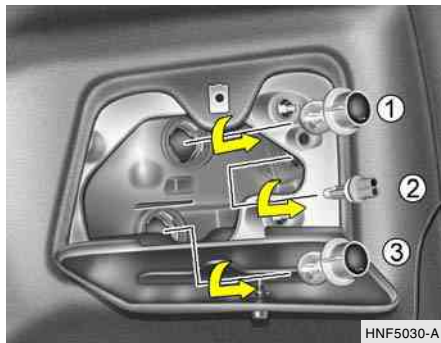

3. To replace the rear combination light (stop/tail light, rear side marker light and rear turn signal light), remove it from the bulb holder and install the new bulb.

- (1) Stop/tail light
- (2) Rear side marker light
- (3) Rear turn signal light



- 4. Loosen the mounting screws of the trunk lid trim with a phillips screwdriver and remove the trunk lid trim.
- 5. To replace the rear combination light (back-up light and stop/tail light), remove the socket by turning it counterclockwise.
- 6. Install the new bulb.

G270C01L-AAT

## LUGGAGE COMPARTMENT LIGHT

1. Open the trunk lid.

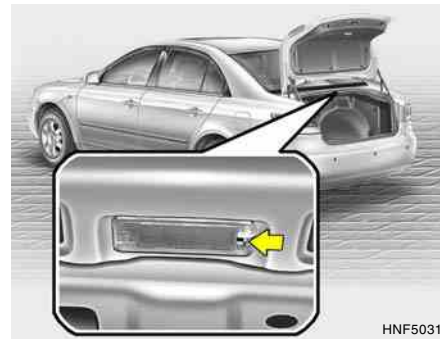

2. Remove the luggage compartment light cover on the rear package tray panel with a flat-head screwdriver.



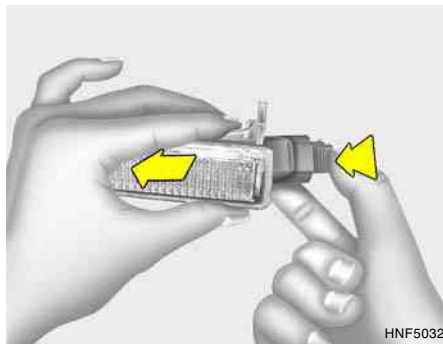

3. Disconnect the power cord.

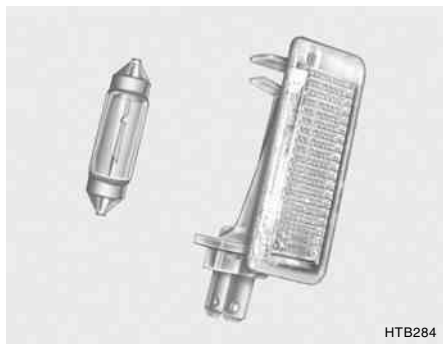

4. Replace with a new bulb.

G270G01L-AAT  
**INTERIOR LIGHT**



1. Remove the plastic cover with a flat-head screwdriver.



2. Replace with a new bulb.

G270L01L-AAT  
**MAP LIGHT**



1. Remove the plastic cover with a flat-head screwdriver.



2. Replace with a new bulb.

G270K01L-AAT  
**GLOVE BOX ILLUMINATED LIGHT**

1. Open the glove box.

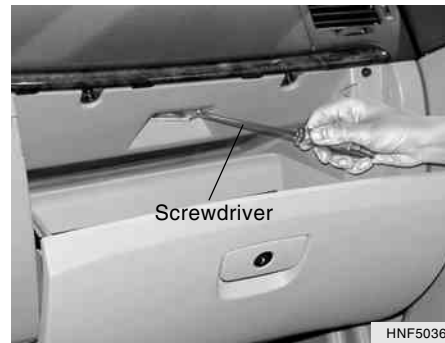

2. Remove the glove box illuminated light cover with a flat-head screwdriver.

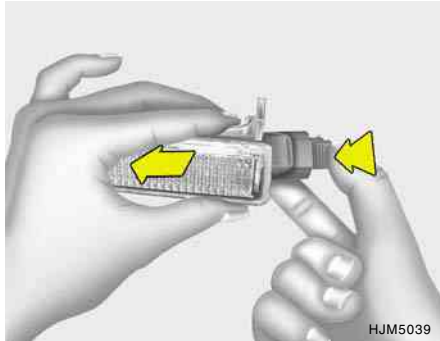

3. Disconnect the power cord.

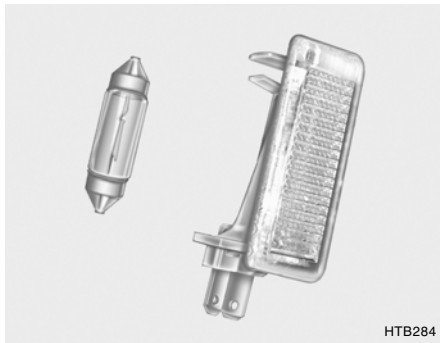

4. Replace with a new bulb.

## 38 BULB WATTAGES

G280A01NF-AAT

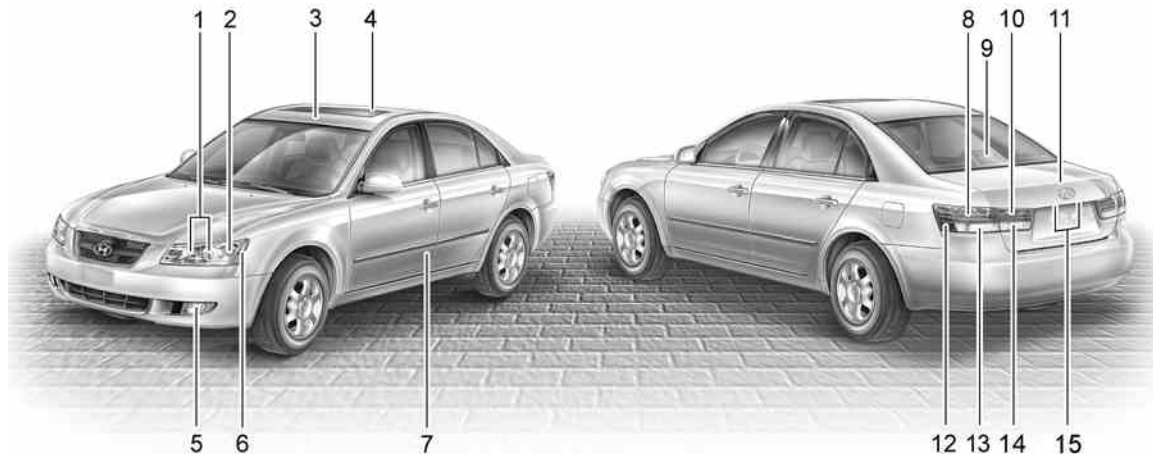

G280A01NF-A

No.	Part Name		Wattage	Socket Type	No.	Part Name	Wattage	Socket Type
1	Headlight	Low beam	55	P x 26d	8	Stop / Tail Light	28/8	BAY 15d
		High beam	55	P14,5s	9	High Mounted Rear Stop Light	16	w2.1 x 9.5d
2	Front Turn Signal Light/Front Position Light		28/8	BAY15d	10	Tail Light	28/8	BAY 15d
3	Map Light		10	w2.1 x 9.5d	11	Luggage Compartment Light	5	sv6-7, 6
4	Interior Light		10	sv6-7,6	12	Rear Side Marker Light	5	BAY 15d
5	Front Fog Light		27	PGJ13	13	Rear Turn Signal Light	27	BAY15s
6	Front Side Marker Light		8	BAY15d	14	Back-up Light	16	w2.1 x 9.5d
7	Front Door Edge Warning Light		8	w2.1 x 4.6d	15	License Plate Light	5	w2.1 x 9.5d

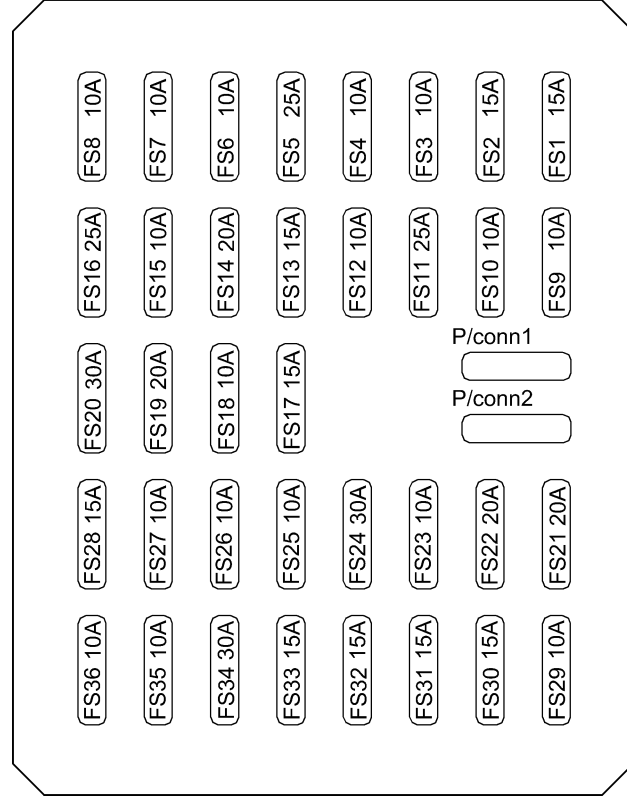

DESCRIPTION		FUSE RATING	PROTECTED COMPONENTS	
FUSIBLE LINK	ABS.1	40A	ABS/ESC control module, Multipurpose check connector	
	ABS.2	20A	ABS/ESC control module, Multipurpose check connector	
	I/P B+1	40A	Fuse 23, 24, 30, 31, 32, 33, 34, 35	
	RR HTD	40A	Defogger relay	
	BLOWER	40A	Blower relay	
	P/WDW	40A	Power window relay, Fuse 16	
	IGN.2	40A	Start relay, Ignition switch (IG2, START)	
	ECU RLY	30A	Engine control unit relay	
	I/P B+2	30A	Power connector 1/2, Fuse 21,22	
	IGN.1	30A	Ignition switch (ACC, IG1)	
	ALT	150A	Fusible link (ABS. 1, ABS. 2, RR HTD, BLOWER)	
MDPS	100A	(Spare)		
FUSE	1	HORN	15A	Horn relay
	2	TAIL	20A	Tail light relay
	3	ECU	10A	PCM
	4	IG1	10A	(Spare)
	5	DRL	15A	Siren relay, DRL control module
	6	FR FOG	15A	Front fog light relay
	7	A/CON	10A	A/C relay
	8	F/PUMP	20A	Fuel pump relay
	9	DIODE	-	(Spare)
	10	ATM	20A	ATM control relay
	11	STOP	15A	Stop light relay
	12	H/LP LO RH	15A	(Spare)
	13	S/ROOF	15A	Sunroof control module
	14	H/LP WASHER	20A	Headlight washer motor
	15	H/LP HI	20A	Headlight relay (High)
	16	ECU	10A	(Spare)
	17	SNSR.3	10A	Oxygen sensor, Fuel pump relay
	18	SNSR.1	15A	Mass air flow sensor, Crankshaft/Camshaft position sensor, Oil control valve, SMATRA
	19	SNSR.2	15A	A/C relay, Cooling fan relay, Injectors
	20	B/UP	10A	Back up light switch, Pulse generator, Vehicle speed sensor
	21	IGN COIL	20A	Ignition coils, Condenser
	22	ECU (IG1)	10A	PCM
	23	H/LP LO	20A	Headlight relay (Low)
	24	ABS	10A	ABS/ESC control module, Multipurpose check connector

G200E01NF-AAT  
Inner Panel

FUSE	FUSE RATING	PROTECTED COMPONENTS
1	15A	(Spare)
2	15A	Seat warmer switch
3	10A	BCM(Body Control Module), Sunroof control module, Electronic chrome mirror
4	10A	ESC module, High blower relay, Humidity sensor
5	25A	Cigarette lighter
6	10A	(Spare)
7	10A	Illumination lights, Right : License light, Rear combination light, Headlight, Glove box light
8	10A	Front fog light relay, Left : License light, Rear combination light, Headlight
9	10A	Headlight washer relay, Right headlight leveling actuator
10	10A	DRL control module, Headlight relay, AQS and ambient sensor, Left headlight leveling actuator
11	25A	Wiper and washer
12	10A	A/C control module
13	15A	SRS control module, Passenger's Airbag switch
14	20A	Front accessory socket, Rear power outlet
15	10A	Digital clock, Audio, A/T shift lock control module, Power outside mirror and mirror folding
16	25A	Safety window module
17	15A	(Spare)
18	10A	A/T shift lock control module
19	20A	Power window main switch, Left rear power window switch
20	30A	Power window main switch, Right power window switch



FUSE	FUSE RATING	PROTECTED COMPONENTS
21	20A	Audio amp
22	20A	Door lock/unlock relay
23	10A	Hazard switch, Hazard relay
24	30A	Power seat manual switch(RHD)
25	10A	Instrument cluster
26	10A	Hazard switch
27	10A	BCM(Body Control Module), Instrument cluster, Yaw rate sensor, ESC switch
28	15A	(Spare)
29	10A	Burglar alarm relay
30	15A	(Spare)
31	15A	Rear fog light relay
32	15A	Trunk lid relay, Fuel filler door and trunk lid switch
33	15A	(Spare)
34	30A	Power seat manual switch
35	10A	Sport mode switch, Key solenoid
36	10A	A/C control module, Outside mirror and mirror folding motor
POWER CONNECTOR. 1	15A	Audio
POWER CONNECTOR. 2	15A	BCM(Body Control Module), Digital clock, Instrument cluster, A/C control module, Courtesy lights

# EMISSION CONTROL SYSTEMS

Emission Control System .....	7-2
Catalytic Converter .....	7-3

# 7

## EMISSION CONTROL SYSTEMS

H010A01NF-AAT

Your Hyundai is equipped with an emission control system to meet all emission regulations. There are three emission control systems which are as follows.

- (1) Crankcase emission control system
- (2) Evaporative emission control system
- (3) Exhaust emission control system

In order to assure the proper function of the emission control systems, it is recommended that you have your car inspected and maintained by an authorized Hyundai dealer in accordance with the maintenance schedule in this manual.

### Caution for the Inspection and Maintenance Test (With Electronic Stability Control (ESC) system)

- o To prevent the vehicle from misfiring during dynamometer testing, turn the Electronic Stability Control (ESC) system off by pressing the ESC switch.
- o After dynamometer testing is completed, turn the ESC system back on by pressing the ESC switch again.

H010B01A-AAT

### 1. Crankcase Emission Control System

The positive crankcase ventilation system is employed to prevent air pollution caused by blow-by gases being emitted from the crankcase. This system supplies fresh filtered air to the crankcase through the air intake hose. Inside the crankcase, the fresh air mixes with blow-by gases, which then pass through the PCV valve into the induction system.

H010C01S-AAT

### 2. Evaporative Emission Control (Including ORVR: Onboard Refueling Vapor Recovery) System

The Evaporative Emission Control System is designed to prevent fuel vapors from escaping into the atmosphere.

(The ORVR system is designed to allow the vapors from the fuel tank to be loaded into a canister while refueling at the gas station, preventing the escape of fuel vapors into the atmosphere.)

### Canister

Fuel vapors generated inside the fuel tank are absorbed and stored in the onboard canister. When the engine is running, the fuel vapors absorbed in the canister are drawn into the surge tank through the purge control solenoid valve.

### Purge Control Solenoid Valve (PCSV)

The purge control solenoid valve is controlled by the Engine Control Module (ECM); when the engine coolant temperature is low during idling, the PCSV closes so that evaporated fuel is not taken into the engine. After the engine warms-up during ordinary driving, the PCSV opens to introduce evaporated fuel to the engine.

H010D01A-AAT

### 3. Exhaust Emission Control System

The Exhaust Emission Control System is a highly effective system which controls exhaust emissions while maintaining good vehicle performance.

## CATALYTIC CONVERTER

H020A01A-AAT

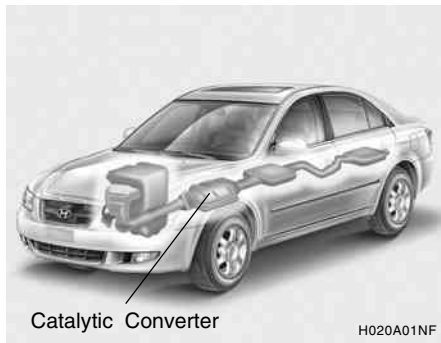

All Hyundai vehicles are equipped with a monolith type three-way catalytic converter to reduce the carbon monoxide, hydrocarbons and nitrogen oxides contained in the exhaust gas. Exhaust gases passing through the catalytic converter cause it to operate at a very high temperature. The introduction of large amounts of unburned gasoline into the exhaust may cause the catalytic converter to overheat and create a fire hazard. This risk may be reduced by observing the following:

### ! WARNING:

- o Use unleaded fuel only.
- o Maintain the engine in good operating condition. Extremely high catalytic converter temperatures can result from improper operation of the electrical, ignition or multiport electronic fuel injection.
- o If your engine stalls, pings, knocks, or is hard to start, have your Hyundai dealer inspect and repair the problem as soon as possible.
- o Avoid driving with a very low fuel level. Running out of gasoline may cause the engine to misfire and result in damage to the catalytic converter.
- o Avoid idling the engine for periods longer than 10 minutes.
- o The vehicle should not be pushed or pulled to get started. This may cause the catalytic converter to overheat and create a fire hazard.
- o Do not touch the catalytic converter or any other part of the exhaust system while the catalytic converter is hot. Shut off the engine, wait for at least one hour before touching the catalytic converter or any other part of the exhaust system.

### ! WARNING:

- o Remember that your Hyundai dealer is your best source of assistance.
- o Do not stop your Hyundai over any combustible material such as grass, paper, leaves or rags. These materials might contact the hot catalytic converter and a fire might result.

# CONSUMER INFORMATION, REPORTING SAFETY DEFECTS & BINDING ARBITRATION OF WARRANTY CLAIMS

Vehicle Identification Number (VIN) .....	8-2
Engine Number .....	8-2
Tire Information .....	8-2
Recommended Inflation Pressures .....	8-3
Checking Tire Inflation Pressure .....	8-4
Tire Sidewall Labeling .....	8-4
Tire Terminology and Definitions .....	8-6
All Season Tires .....	8-8
Summer Tires .....	8-8
Snow Tires .....	8-8
Tire Chains .....	8-8
Tire Rotation .....	8-9
Tire Balancing .....	8-9
Tire Traction .....	8-10
When to Replace Tires .....	8-10
Tire Maintenance .....	8-11
Spare Tire and Tools .....	8-11
Warranties for Your Hyundai Vehicle .....	8-12
Consumer Information .....	8-12
Reporting Safety Defects .....	8-14
Binding Arbitration of Warranty Claims .....	8-15

# 8

2

## VEHICLE IDENTIFICATION NUMBER (VIN)

I010A01O-AAT

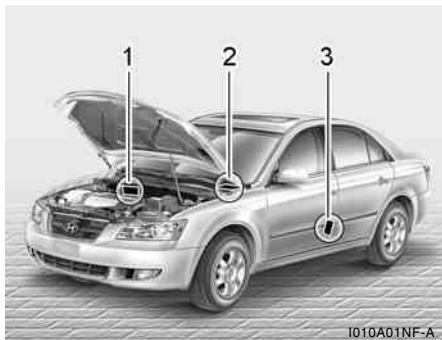

The vehicle identification number (VIN) is the number used in registering your car and in all legal matters pertaining to its ownership, etc. It can be found in three different places on your car:

1. On the bulkhead between the engine and passenger compartments.
2. On the left top side of the instrument panel where it can be seen by looking down through the windshield.
3. On the lower side of the center pillar outer panel.

## ENGINE NUMBER

I010B01A-AAT

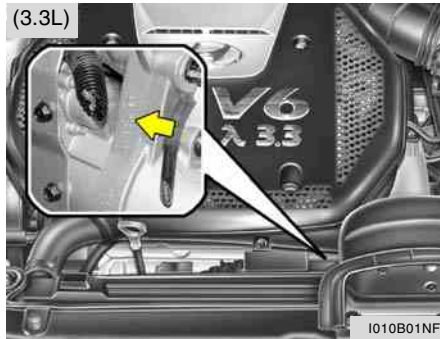
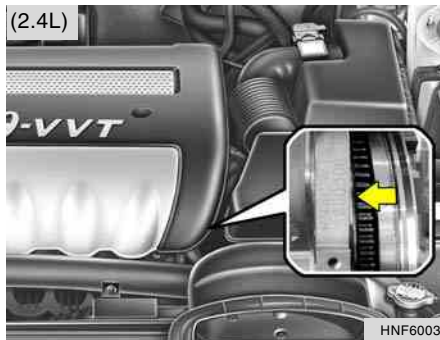

The engine number is stamped on the engine block as shown in the drawing.

## TIRES

I020A02A-AAT

### TIRE INFORMATION

The tires supplied on your new Hyundai are chosen to provide the best performance for normal driving.

If you ever have questions about your tire warranty and where to obtain service, see the tire manufacturer's booklet included with your vehicle's Owner's Manual Literature Kit.

I030A01NF-AAT

**RECOMMENDED INFLATION PRESSURES**

I030A01NF-A

Tire label located on the driver's side of the center pillar outer panel gives the cold tire pressures recommended for your vehicle with the original tire size, the number of people that can be in your vehicle and vehicle capacity weight.

TIRE AND LOADING INFORMATION			
SEATING CAPACITY	TOTAL 5	FRONT 2	REAR 3
The combined weight of occupants and cargo should never exceed 390 kg or 860 lbs.			
TIRE	SIZE	COLD TIRE PRESSURE	
FRONT	P215 / 60R16	210KPA, 30PSI	
REAR	P215 / 60R16	210KPA, 30PSI	
SPARE	T125 / 80D16	420KPA, 60PSI	
SEE OWNER'S MANUAL FOR ADDITIONAL INFORMATION			

I030A03NF-A

TIRE AND LOADING INFORMATION			
SEATING CAPACITY	TOTAL 5	FRONT 2	REAR 3
The combined weight of occupants and cargo should never exceed 390 kg or 860 lbs.			
TIRE	SIZE	COLD TIRE PRESSURE	
FRONT	P225 / 50R17	210KPA, 30PSI	
REAR	P225 / 50R17	210KPA, 30PSI	
SPARE	T125 / 80D16	420KPA, 60PSI	
SEE OWNER'S MANUAL FOR ADDITIONAL INFORMATION			

I030A04NF-A

These pressures were chosen to provide the most satisfactory combination of ride comfort, tire wear and stability under normal conditions. Tire pressures should be checked at least monthly. Proper tire inflation pressures should be maintained for these reasons:

**WARNING:**

- o Lower-than-recommended tire pressures cause uneven tread wear, poor handling, poor fuel economy or tire failure.
- o Higher-than-recommended tire pressures can cause poor handling, uneven tread wear or tire failure.

**CAUTION:**

Always observe the following:

- o Check pressures when the tires are cold. (After the vehicle has been parked for at least three hours or hasn't been driven more than 1 mile (1.6 km) since starting up.)

- o **Check the pressure of your spare tire each time you check the pressure of other tires.**
- o **Worn, old tires can cause accidents. If your tread is badly worn, or if your tires have been damaged, replace them.**

I035A01JM-AAT

### CHECKING TIRE INFLATION PRESSURE

Check your tires once a month or more. Also, check the tire pressure of the spare tire.

#### How to Check

Use a good quality gauge to check tire pressure. You cannot tell if your tires are properly inflated simply by looking at them. Radial tires may look properly inflated even when they're underinflated.

Check the tire's inflation pressure when the tires are cold. - "Cold" means your vehicle has been sitting for at least three hours or driven no more than 1 mile (1.6 km).

Remove the valve cap from the tire valve stem. Press the tire gauge firmly onto the valve to get a pressure measurement. If the cold tire inflation pressure matches the recommended pressure on the tire and loading information label, no further adjustment is necessary. If the pressure is low, add air until you reach the recommended amount. If you overfill the tire, release air by pushing on the metal stem in the center of the tire valve. Recheck the tire pressure with the tire gauge. Be sure to put the valve caps back on the valve stems. They help prevent leaks by keeping out dirt and moisture.

I030B01NF-AAT

### TIRE SIDEWALL LABELING

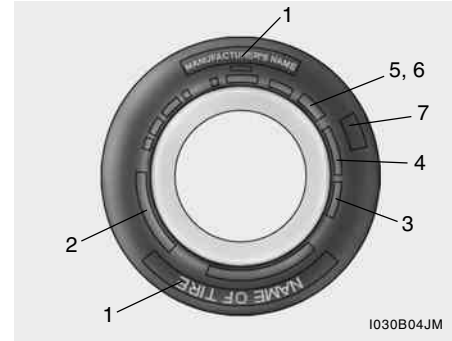

Federal law requires tire manufacturers to place standardized information on the sidewall of all tires. This information identifies and describes the fundamental characteristics of the tire and also provides the tire identification number (TIN) for safety standard certification. The TIN can be used to identify the tire in case of a recall.



## 1. Manufacturer or Brand name

- o Manufacturer or Brand name is shown.

## 2. Tire size

(example: P215/60R16 94V)

- o The "P" indicates the tire is designed for passenger vehicles.
- o Three-digit number (215): This number gives the width in millimeters of the tire from sidewall edge to sidewall edge.
- o Two-digit number (60): This number, known as the aspect ratio, gives the tire's ratio of height to width.
- o R: The "R" stands for radial.
- o Two-digit number (16): This number is the wheel or rim diameter in inches.
- o Two digit number (94): This number is the tire's load index. It is a measurement of how much weight each tire can support.

- o V: Speed Rating. The speed rating denotes the speed at which a tire is designed to be driven for extended periods of time. The ratings range from "A" to "Z" (98 to 186 MPH).

## 3. TIN (Tire Identification Number) for new tire (example: DOT XX XX XXX XXXX)

- o DOT: Abbreviation for the "Department of Transportation". The symbol can be placed above, below or to the left or right of the Tire Identification Number. It indicates the tire is in compliance with the U.S. Department of Transportation Motor Vehicle Safety Standards.
- o 1st two-digit code: Manufacturer's identification mark
- o 2nd two-digit code: Tire size
- o 3rd three-digit code: Tire type code (Optional)
- o 4th four-digit code: Date of Manufacture

- o Four numbers represent the week and year the tire was built. For example, the numbers 3105 means the 31st week of 2005.

## 4. Tire ply composition and material

The number of layers or plies of rubbercoated fabric in the tire. Tire manufacturers also must indicate the materials in the tire, which include steel, nylon, polyester, and others. The letter "R" means radial ply construction; the letter "D" means diagonal or bias ply construction; and the letter "B" means belted-bias ply construction.

## 5. Maximum permissible inflation pressure

This number is the greatest amount of air pressure that should be put in the tire. Do not exceed the maximum permissible inflation pressure. Refer to the Tire and Loading Information label for recommended inflation pressure.

## 6. Maximum load rating

This number indicates the maximum load in kilograms and pounds that can be carried by the tire. When replacing the tires on the vehicle, always use a tire that has the same load rating as the factory installed tire.

## 7. Uniform Tire Quality Grading (UTQG):

Tire manufacturers are required to grade tires based on three performance factors: treadwear, traction and temperature resistance. For more information, see Uniform Tire Quality Grading on page 8-13.

1030D01JM-AAT

## TIRE TERMINOLOGY AND DEFINITIONS

**Air Pressure:** The amount of air inside the tire pressing outward on the tire. Air pressure is expressed in pounds per square inch (psi) or kilopascal (kPa).

**Accessory Weight:** This means the combined weight of optional accessories. Some examples of optional accessories are, automatic transmission, power seats, and air conditioning.

**Aspect Ratio:** The relationship of a tire's height to its width.

**Belt:** A rubber coated layer of cords that is located between the plies and the tread. Cords may be made from steel or other reinforcing materials.

**Bead:** The tire bead contains steel wires wrapped by steel cords that hold the tire onto the rim.

**Bias Ply Tire:** A pneumatic tire in which the plies are laid at alternate angles less than 90 degrees to the centerline of the tread.

**Cold Tire Pressure:** The amount of air pressure in a tire, measured in pounds per square inch (psi) or kilopascals (kPa) before a tire has built up heat from driving.

**Curb Weight:** This means the weight of a motor vehicle with standard and optional equipment including the maximum capacity of fuel, oil and coolant, but without passengers and cargo.

**DOT Markings:** A code molded into the sidewall of a tire signifying that the tire is in compliance with the U.S. Department of Transportation motor vehicle safety standards. The DOT code includes the Tire Identification Number (TIN), an alphanumeric designator which can also identify the tire manufacturer, production plant, brand and date of production.

**GVWR:** Gross Vehicle Weight Rating

**GAWR FRT:** Gross Axle Weight Rating for the front Axle.

**GAWR RR:** Gross Axle Weight Rating for the rear axle.

**Intended Outboard Sidewall:** The side of an asymmetrical tire, that must always face outward when mounted on a vehicle.

**Kilopascal (kPa):** The metric unit for air pressure.

**Load Index:** An assigned number ranging from 1 to 279 that corresponds to the load carrying capacity of a tire.

**Maximum Inflation Pressure:** The maximum air pressure to which a cold tire may be inflated. The maximum air pressure is molded onto the sidewall.

**Maximum Load Rating:** The load rating for a tire at the maximum permissible inflation pressure for that tire.

**Maximum Loaded Vehicle Weight:** The sum of curb weight; accessory weight; vehicle capacity weight; and production options weight.

**Normal Occupant Weight:** The number of occupants a vehicle is designed to seat multiplied by 150 pounds (68 kg).

**Occupant Distribution:** Designated seating positions.

**Outward Facing Sidewall:** The side of an asymmetrical tire that has a particular side that faces outward when mounted on a vehicle. The side of the tire that contains a whitewall, bears white lettering or bears manufacturer, brand and or model name molding that is higher or deeper than the same moldings on the other sidewall of the tire.

**Passenger (P-Metric) Tire:** A tire used on passenger cars and some light duty trucks and multipurpose vehicles.

**Recommended Inflation Pressure:** Vehicle manufacturer's recommended tire inflation pressure as shown on the tire placard.

**Radial Ply tire:** A pneumatic tire in which the ply cords that extend to the beads are laid at 90 degrees to the centerline of the tread.

**Rim:** A metal support for a tire upon which the tire beads are seated.

**Sidewall:** The portion of a tire between the tread and the bead.

**Speed Rating:** An alphanumeric code assigned to a tire indicating the maximum speed at which a tire can operate.

**Traction:** The friction between the tire and the road surface. The amount of grip provided.

**Tread:** The portion of a tire that comes into contact with the road.

**Treadwear Indicators:** Narrow bands, sometimes called "wear bars," that show across the tread of a tire when only 2/32 inch of tread remains.

**UTQGS:** Uniform Tire Quality Grading Standards, a tire information system that provides consumers with ratings for a tire's traction, temperature and treadwear. Ratings are determined by tire manufacturers using government testing procedures. The ratings are molded into the sidewall of the tire.

**Vehicle Capacity Weight:** The number of designated seating positions multiplied by 150 lbs. (68 kg) plus the rated cargo and luggage load.

**Vehicle Maximum Load on the Tire:** Load on an individual tire due to curb and accessory weight plus maximum occupant and cargo weight.

**Vehicle Normal Load on the Tire:** That load on an individual tire that is determined by distributing to each axle its share of the curb weight, accessory weight, and normal occupant weight and dividing by 2.

**Vehicle Placard:** A label permanently attached to a vehicle showing the original equipment tire size and recommended inflation pressure.

I040B01JM-AAT

## ALL SEASON TIRES

Hyundai specifies all season tires on some models to provide good performance for use all year round, including snowy and icy road conditions. All sea-

son tires are identified by ALL SEASON and/or M+S (Mud and Snow) on the tire sidewall. Snow tires have better snow traction than all season tires and may be more appropriate in some areas.

I040C01JM-AAT

## SUMMER TIRES

Hyundai specifies summer tires on some models to provide superior performance on dry roads. Summer tire performance is substantially reduced in snow and ice. Summer tires do not have the tire traction rating M+S (Mud and Snow) on the tire side wall. If you plan to operate your vehicle in snowy or icy conditions, Hyundai recommends the use of snow tires or all season tires on all four wheels.

I040A01O-AAT

## SNOW TIRES

If you equip your car with snow tires, they should be the same size and have the same load capacity as the original tires. Snow tires should be installed on

all four wheels; otherwise, poor handling may result.

Snow tires should carry 4 psi (28 kPa) more air pressure than the pressure recommended for the standard tires on the tire label on the driver's side of the center pillar, or up to the maximum pressure shown on the tire sidewall, whichever is less.

Do not drive faster than 75 mph (120 km/h) when your car is equipped with snow tires.

I050A03Y-AAT

## TIRE CHAINS

Tire chains, if necessary, should be installed on the front wheels. Be sure that the chains are the proper size and that they are installed in accordance with the manufacturer's instructions.

To minimize tire and chain wear, do not continue to use tire chains when they are no longer needed.

**WARNING:**

- o When driving on roads covered with snow or ice, drive at less than 20 mph (30 km/h).
- o Use the SAE "S" class or wire & plastic chains.
- o If you have noise caused by chains contacting the body, retighten the chain to avoid contact with the vehicle body.
- o To prevent body damage, retighten the chains after driving 0.3~0.6 miles.
- o Don't use a tire chains to the vehicle which aluminium wheels are installed to keep the wheels. If it is on unavoidable circumstances, use a wire chains.
- o Use wire chains less than 15mm to prevent damage to the chain's connection.

I060A02A-AAT

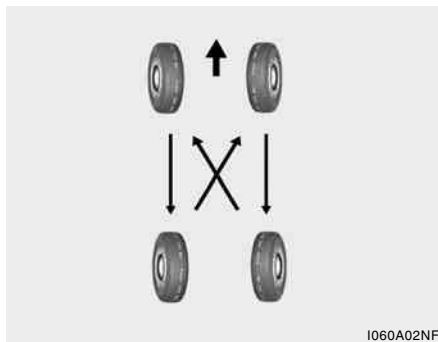
**TIRE ROTATION**

Tires should be rotated every 7,500 miles (12,000 km). If you notice that tires are wearing unevenly between rotations, have the car checked by a Hyundai dealer so the cause may be corrected.

After rotating, adjust the tire pressures and be sure to check the wheel nut torque.

**WARNING:**

- o Do not use the temporary spare tire for tire rotation.
- o Do not mix bias ply and radial ply tires under any circumstances. This may cause unusual handling characteristics that could result in death, serious injury, or property damage.

I070A01A-AAT

**TIRE BALANCING**

A tire that is out of balance may affect handling and tire wear. The tires on your Hyundai were balanced before the car was delivered but may need balancing again during the years you own the car. Whenever a tire is dismantled for repair, it should be rebalanced before being reinstalled on the car.

I080A01A-AAT

**TIRE TRACTION**

Tire traction can be reduced if you drive on worn tires, tires that are improperly inflated or on slippery road surfaces. Tires should be replaced when tread wear indicators appear. To reduce the possibility of losing control, slow down whenever there is rain, snow or ice on the road.

I090A02A-AAT

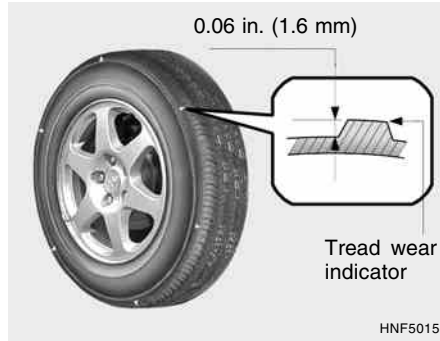
**WHEN TO REPLACE TIRES**

The original tires on your car have tread wear indicators. The location of tread wear indicators is shown by the "TWI" or " $\Delta$ " marks, etc. The tread wear indicators appear when the tread depth is 0.06 in. (1.6 mm). The tire should be replaced when these appear as a solid bar across two or more grooves of the tread. Always replace your tires with those of the recommended size. If you change wheels, the new wheel's rim width and offset must meet Hyundai specification.

**WARNING:**

- o **Driving on worn-out tires is dangerous! Worn-out tires can cause loss of braking effectiveness, steering control and traction. When replacing tires, never mix radial and bias ply tires on the same car. If you replace radial tires with bias ply tires, they must be installed in sets of four.**
- o **Using tires and wheels of other than the recommended sizes could cause unusual handling characteristics that could cause death, serious injury, or property damage.**
- o **Wheels that do not meet Hyundai's dimensional specifications may fit poorly and result in damage to the vehicle, including broken wheel studs.**

## SPARE TIRE AND TOOLS

I090B01JM-AAT

### TIRE MAINTENANCE

In addition to proper inflation, correct wheel alignment helps to decrease tire wear. If you find a tire is worn unevenly, have your dealer check the wheel alignment.

When you have new tires installed, make sure they are balanced. This will increase vehicle ride comfort and tire life. Additionally, a tire should always be rebalanced if it is removed from the wheel.

I100A01NF-AAT

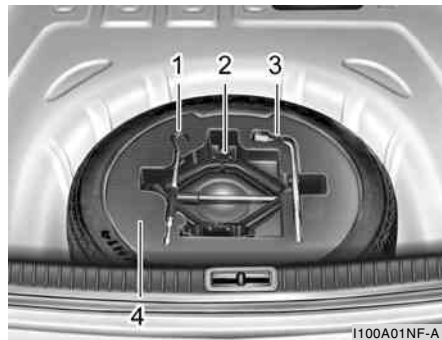

Your Hyundai is delivered with the following:

- Spare tire and wheel
- Wrench bar (1)
- Jack (2)
- Wheel nut wrench (3)
- Tool receptacle (4)

I110A01A-AAT

### SHOP MANUAL

A Hyundai Shop Manual is available from your authorized Hyundai dealer. It's written for professional technicians, but is simple enough for most mechanically-inclined owners to understand.

## WARRANTIES FOR YOUR HYUNDAI VEHICLE

I120A02A-AAT

- o New vehicle 60 Months/60,000 Miles Limited Warranty.
- o New vehicle 120 Months/100,000 Miles Limited Powertrain Warranty (Original owner only).
- o Anti-Perforation Limited Warranty
- o Emission Defect Warranty - Federal Vehicle
- o California Emission Control System Warranty (if applicable)
- o Emission Performance Warranty Federal vehicle
- o Replacement Parts and Accessories Limited Warranty

### NOTE:

Detailed warranty information is provided in your Hyundai Owner's Handbook.

## CONSUMER INFORMATION

I130A01A-AAT

This consumer information has been prepared in accordance with regulations issued by the National Highway Traffic Safety Administration of the U.S. Department of Transportation. It provides the purchasers and/or prospective purchasers of Hyundai automobiles with information on uniform tire quality grading. Your Hyundai dealer will help answer any questions you may have as you read this information.

I130B04A-AAT

### Tire Quality Grading

Department of Transportation quality grades - All passenger vehicle tires must conform to Federal Safety Standards in addition to these grades. These quality grades are molded on the sidewall.

**Treadwear** - The treadwear grade is a comparative rating based on the wear rate of the tire when tested under controlled conditions on a specified government test course. For example, a tire graded 150 would wear one and a half (1 - 1/2) times as well on the government course as a tire graded 100. The relative performance of tires depends upon the actual conditions of their use, however, and may depart significantly from the norm due to variations in driving habits, service practices and differences in road characteristics and climate.



**Traction AA, A, B, C** - The traction grades, from highest to lowest, are AA, A, B, and C. Those grades represent the tire's ability to stop on wet pavement as measured under controlled conditions on specified government test surfaces of asphalt and concrete. A tire marked C may have poor traction performance.

 **WARNING:**  
**The traction grade assigned to this tire is based on straight-ahead braking traction tests, and does not include acceleration, cornering, hydroplaning, or peak traction characteristics.**

**Temperature A, B, C** - The temperature grades are A (the highest), B, and C, representing the tire's resistance to the generation of heat and its ability to dissipate heat when tested under controlled conditions on a specified indoor laboratory test wheel. Sustained high temperature can cause the material of the tire to degenerate and reduce tire life, and excessive temperature can lead to sudden tire failure. The grade C corresponds to a level of performance which all passenger car tires must meet under the Federal Motor Vehicle Safety Standard No. 109. Grades B and A represent higher levels of performance on the laboratory test wheel than the minimum required by law.

 **WARNING:**  
**The temperature grade for this tire is established for a tire that is properly inflated and not overloaded. Excessive speed, underinflation, or excessive loading, either separately or in combination, can cause heat buildup and possible tire failure.**

**Uniform Tire Quality Grading** - Quality grades can be found on the tire sidewall between the tread shoulder and the maximum section width.  
For example :  
Treadwear 200 Traction AA Temperature A

I130D03A-AAT

Hyundai motor vehicles are designed and manufactured to meet or exceed all applicable safety standards.

For your safety, however, we strongly urge you to read and follow all directions in this Owner's Manual, particularly the information under the headings "**NOTE**", "**CAUTION**" and "**WARNING**".

If, after reading this manual, you have any questions regarding the operation of your vehicle, please contact your nearest Hyundai Motor America Regional Office as listed below:

**Eastern Region** : Connecticut, Delaware, Maine, Maryland, Massachusetts, New Hampshire, New Jersey, New York, Pennsylvania, Rhode Island, Vermont, Virginia, West Virginia.

Eastern Region  
1100 Cranbury South River Road  
Jamesburg, NJ 08831  
(800) 633-5151

**Southern Region:** Alabama, Arkansas, Florida, Georgia, Louisiana, Mississippi, North Carolina, South Carolina, Oklahoma, Tennessee, Texas.

Southern Region  
270 Riverside Parkway, Suite A  
Austell, GA 30168  
(800) 633-5151

**Central Region:** Illinois, Indiana, Missouri, Iowa, Kansas, Kentucky, Michigan, Minnesota, Nebraska, North Dakota, South Dakota, Ohio, Wisconsin.

Central Region  
1705 Sequoia Drive  
Aurora, Illinois 60506  
(800) 633-5151

**Western Region:** Alaska, Hawaii, Arizona, California, Colorado, Idaho, Montana, Nevada, New Mexico, Oregon, Texas, Utah, Washington, Wyoming.

Western Region  
10550 Talbert Avenue  
P.O.Box 20850  
Fountain Valley, California 92728-0850  
(800) 633-5151

## REPORTING SAFETY DEFECTS

I130C01A-AAT

If you believe that your vehicle has a defect which could cause a crash or could cause injury or death, you should immediately inform the National Highway Traffic Safety Administration (NHTSA) in addition to notifying HYUNDAI MOTOR AMERICA. If NHTSA receives similar complaints, it may open an investigation, and if it finds that a safety defect exists in a group of vehicles, it may order a recall and remedy campaign. However, NHTSA cannot become involved in individual problems between you, your dealer, or HYUNDAI MOTOR AMERICA.

To contact NHTSA, you may either call the Auto Safety Hotline toll-free at 1-888-327-4236 or write to: NHTSA, U.S. Department of Transportation, Washington, D.C. 20590. You can also obtain other information about motor vehicle safety from the Hotline.

## BINDING ARBITRATION

I140A01A-AAT

Any claim or dispute you may have related to your vehicle's warranty or the duties contemplated under the warranty, including claims related to the refund or partial refund of your vehicle's purchase price (excluding personal injury or product liability claims), shall be resolved by binding arbitration. Binding arbitration shall be administered by and through the National Arbitration Forum (NAF) or the American Arbitration Association (AAA), under the Code of Procedure of the entity you select.

You will not be responsible for paying filing and hearing fees above \$275.00. All other arbitration costs shall be borne by Hyundai Motor America. You are not responsible to pay any of the costs Hyundai incurs.

This Binding Arbitration Agreement shall not deprive you of any remedies available to you under applicable law. The parties are waiving their right to seek remedies in court, including the right to a jury trial.

This Binding Arbitration Agreement shall be governed by and interpreted under the Federal Arbitration Act, 9 U.S.C. sections 1-16. Judgment upon any award may be entered in any court having jurisdiction.

You may revoke this Arbitration Agreement by (1) written notice or (2) electronic notice. Written notice must be delivered (via certified mail) to Hyundai Motor America, Attn: Consumer Affairs, 10550 Talbert Avenue, P.O. Box 20849, Fountain Valley, CA 92728-0849. Electronic notice must be submitted at the following website address: <http://warranty-arbitration.hyundaiUSA.com>. Notice must be received within 90 days after you purchase your vehicle.

## VEHICLE SPECIFICATIONS

Measurement .....	9-2
Engine .....	9-3
Lubrication Chart .....	9-4

# 9

J010A02NF-AAT

**MEASUREMENT**

in.(mm)

ITEM		2.4L/3.3L
Overall length		189.9 (4800)
Overall width		72.1 (1832)
Overall height		58.0 (1475)
Wheel base		107.4 (2730)
Wheel tread	Front	61.6 (1565)
	Rear	61.1 (1550)

J020A01NF-AAT

**POWER STEERING**

Type	Rack and pinion
Wheel free play	0 ~ 1.18 in. (0 ~ 30 mm)
Rack stroke	5.90 in. (150 mm)
Oil pump type	Vane type

J060A01NF-AAT

**FUEL SYSTEM**

Fuel tank capacity	17.7us.gal (14.7 imp.gal, 67 liter)
--------------------	-------------------------------------

J030A01NF-AAT

**TIRE**

Standard	P215/60R16
Option	P225/50R17
Spare	T125/80D16 (Temporary)

J040A01NF-GAT

**ELECTRICAL**

Item	2.4L	3.3L
Battery	MF68AH	
Alternator	110A (13.5V)	130A (13.5V)

J050A01NF-AAT

**BRAKE**

Type	Dual hydraulic with brake booster
Front brake type	Ventilated disc
Rear brake type	Disc type
Parking brake	Cable operated on rear wheel

## ENGINE

J070A01NF-AAT

ITEMS		2.4L	3.3L
Engine Type		4-Cyl., In-line DOHC	6-Cyl., V-type DOHC
Bore x Stroke in.(mm)		3.46 x 3.81 (88 x 97)	3.62 x 3.29 (92.0 x 83.8)
Displacement cu.in.(cc)		143.9(2,359)	203.9 (3,342)
Firing order		1 - 3 - 4 - 2	1 - 2 - 3 - 4 - 5 - 6
Valve clearance (cold engine)	Intake	0.006 ~ 0.009 in. (0.17 ~ 0.23 mm)	
	Exhaust	0.01 ~ 0.012 in. (0.27 ~ 0.33 mm)	
Spark plug		SK16PR-A11	IFR5G-11
Spark plug gap		0.039 ~ 0.043 in. (1.0 - 1.1 mm)	
Idle speed (rpm)		650 ± 100	620 ± 100
Ignition timing (Base)		BTDC 8° ± 5°	BTDC 10° ± 5°

**LUBRICATION CHART**

J080A02NF-AAT

Item		Oil & Grease Standard	Quantity (Us. qts)(Imp. qts, Liter)
Engine Oil		API SJ, SL or ABOVE, ILSAC GF-3 or ABOVE	SAE 5W-20, SAE 5W-30 (ALL TEMP. RANGE) SAE 10W-30 (ABOVE 0°F(-18°C))
Drain and refill (With oil filter); 2.4L : 4.54 (3.78, 4.3) 3.3L : 6.02 (5.02, 5.7)			
Transaxle	Manual	HYUNDAI GENUINE PARTS MTF 75W/85 (API GL-4)	2.0 (1.67, 1.9)
	Automatic	HYUNDAI GENUINE ATF SP III, DIAMOND ATF SP III, SK ATF SP III or other brands meeting the SP III specification approved by Hyundai Motor Co..	2.4L : 8.24 (6.86, 7.8) 3.3L : 11.52 (9.59, 10.9)
Coolant	Manual Transaxle	Ethylene glycol base for aluminum radiator	2.4L : 6.87 (5.72, 6.5)
	Automatic Transaxle		2.4L : 6.66 (5.54, 6.3) 3.3L : 8.66 (7.21, 8.2)
Power steering		PSF-3 TYPE FLUID	0.95 (0.79, 0.9)
Brake and clutch fluid		DOT 3 or DOT 4 Equivalent	As required

# INDEX

# 10





- A**
- Accessory Box ..... 1-75
  - Advanced Supplemental Restraint (AIRBAG) System (SRS) ..... 1-36
    - Curtain airbag ..... 1-47
    - Driver's and passenger's front airbag ..... 1-37
    - Occupant classification system ..... 1-42
    - Side impact airbag ..... 1-45
  - Air Cleaner Filter ..... 6-14
  - Air Conditioning
    - Care ..... 6-21
    - Filter ..... 1-112, 6-22
    - Operation ..... 1-103, 6-21
    - Switch ..... 1-103
  - Antenna ..... 1-130
  - Ashtray ..... 1-68
  - Audio System
    - Audio remote control switch ..... 1-95
    - Compact disc player operation (V480) ..... 1-118
    - Compact disc player operation (V490) ..... 1-125
    - Stereo radio operation (V480) ..... 1-115
    - Stereo radio operation (V490) ..... 1-122
  - Automatic Heating and Cooling Control System ..... 1-106
  - Automatic-Dimming Mirror with Z-Nav™ Electronic Compass
    - Display and HomeLink® ..... 1-79
- B**
- Battery ..... 6-27
  - Binding Arbitration ..... 8-15
  - Brake
    - Anti-lock brake system (ABS) ..... 2-12
    - Checking the brakes ..... 6-20
    - Fluid ..... 6-20
    - Pedal clearance ..... 6-24
    - Pedal free-play ..... 6-24
    - Practices ..... 2-14
  - Breaking-In your New Hyundai ..... 1-3
- C**
- Care of Discs ..... 1-130
  - Catalytic Converter ..... 7-3
  - Center Console Compartment ..... 1-76
  - Child Restraint System ..... 1-28
    - Installing a child restraint system with
      - "Tether Anchorage" system ..... 1-30
      - Securing a child restraint system with "ISOFIX" system ..... 1-31
  - Child-Protector Rear Door Lock ..... 1-6
  - Cigarette Lighter ..... 1-67
  - Clock ..... 1-66
  - Clutch
    - Pedal free-play ..... 6-23

- Combination Light
  - Auto Light ..... 1-63
  - Headlight flasher ..... 1-63
  - Headlight switch ..... 1-62
  - High-beam switch ..... 1-62
  - Lane change signal ..... 1-62
  - Parking light auto off ..... 1-62
  - Turn signal operation ..... 1-61
- Consumer Information ..... 8-12
- Cooling Fans ..... 6-28
- Corrosion protection
  - Cleaning the interior ..... 4-5
  - Protecting your Hyundai from corrosion ..... 4-2
  - Washing and waxing ..... 4-3
- Cruise Control ..... 1-93
  
- D**
- Day/night Inside Rearview Mirror ..... 1-78
- Defrosting/Defogging ..... 1-105
- Door
  - Central door locks ..... 1-6
  - Door locks ..... 1-4
  - Front door warning light ..... 1-92
  - Locking and unlocking front door with a key ..... 1-5
- Drink Holder ..... 1-68
- Driving
  - Economical driving ..... 2-15
  - Smooth cornering ..... 2-16
  - Winter driving ..... 2-16
  
- E**
- Electronic Stability Control (ESC) System ..... 2-13
- Emission Control System ..... 7-2
- Engine
  - Before starting the engine ..... 2-3
  - Compartment (2.4 DOHC) ..... 6-2
  - Compartment (3.3 V6) ..... 6-3
  - Coolant ..... 6-8
  - Coolant temperature gauge ..... 1-56
  - If the engine overheats ..... 3-4
  - Number ..... 8-2
  - Oil ..... 6-5
  - Starting ..... 2-4
- Engine Exhaust Can Be Dangerous! ..... 2-2
  
- F**
- Fan Speed Control ..... 1-97, 1-108
- Fog Light
  - Front ..... 1-64
- Front Seats
  - Active headrests ..... 1-16
  - Adjustable front seats ..... 1-14
  - Adjustable headrests ..... 1-15
  - Adjusting seat forward and rearward ..... 1-14, 1-17
  - Adjusting seatback angle ..... 1-14, 1-18
  - Power driver's seat ..... 1-17
  - Seat cushion height adjustment ..... 1-17, 1-18
  - Seat warmer ..... 1-19

- Fuel
  - Capacity ..... 9-2
  - Gauge ..... 1-55
  - Recommendations ..... 1-2
- Fuel Filler Lid
  - Remote release ..... 1-87
- Fuse Panel Description ..... 6-39
- Fuses ..... 6-25
  
- G**
- General Checks ..... 6-4
- Glove Box ..... 1-74
  
- H**
- Hazard Warning System ..... 1-65
- Headlight
  - Aiming adjustment ..... 6-30
  - Replacement ..... 6-31
  - Switch ..... 1-62
- Heating and Cooling Control ..... 1-96
- Heating and Ventilation
  - Air flow control ..... 1-98, 1-110
  - Air intake control switch ..... 1-101, 1-108
  - Bi-level heating ..... 1-102
  - Defrosting/Defogging ..... 1-105
  - Fan speed control (Blower Control) ..... 1-97, 1-108
  - Temperature control ..... 1-97
  
- High-Mounted Rear Stop Light ..... 1-87
- Hood Release ..... 1-89
- Horn ..... 1-92
  
- I**
- Ignition Switch ..... 2-3
- Instrument Cluster and Indicator Lights ..... 1-50
- Instrument Panel Light Control (Rheostat) ..... 1-67
- Interior Light ..... 1-73
- Intermittent Wiper ..... 1-65
  
- J**
- Jump Starting ..... 3-3
  
- K**
- Key ..... 1-3
  - If you lose your keys ..... 3-13
  - Positions ..... 2-3
  
- L**
- Light Bulb Watages ..... 6-38
- Light Bulbs Replacement ..... 6-31
- Lubrication Chart ..... 9-4

**M**

Maintenance Intervals	
Explanation of scheduled maintenance items .....	5-7
Maintenance under severe usage conditions .....	5-6
Scheduled maintenance .....	5-4
Service requirements .....	5-2
Mirrors	
Day/night inside rearview .....	1-78
Homelink mirror .....	1-79
Outside rearview .....	1-77
Outside rearview mirror heater .....	1-78
Multi Box .....	1-75

**O**

Odometer .....	1-57
Outside Rearview Mirror .....	1-77

**P**

Parking Brake .....	1-85
Power Adjustable Pedals .....	2-11
Power Outlets .....	1-67
Power Steering Fluid Level .....	6-29

**R**

Rear Seat	
Armrest .....	1-92
Folding rear seatbacks .....	1-19
Rear seatback safety lock .....	1-20
Warning .....	1-20
Rear Window Defroster Switch .....	1-66
Reporting Safety Defects .....	8-14

**S**

Seat	
Front .....	1-14
Rear .....	1-19
Seat Belts	
3-Point system .....	1-24
Adjusting your seat belt .....	1-25
Care of seat belts .....	1-22
Pre-tensioner seat belt .....	1-33
Precautions .....	1-21
Rear seat center 3-point system with combination locking retractor .....	1-26
Seatback Pocket .....	1-70
Shopping Bag Holder .....	1-69
Spark Plugs .....	6-11
Spectacle Case .....	1-74
Speedometer .....	1-57
Starting Procedure .....	2-5

## Steering Wheel

Free-play .....	6-23
Tilt and telescopic type .....	1-91
Tilt type .....	1-91
Stereo Sound System .....	1-113
Sun Visor .....	1-90
Sunroof .....	1-70

**T**

Tachometer .....	1-56
Theft-Alarm System .....	1-8

## Tires

All season tires .....	8-8
Balancing .....	8-9
Chains .....	8-8
Changing a flat tire .....	3-6
Checking the inflation pressure .....	8-4
If you have a flat tire .....	3-6
Information .....	8-2
Maintenance .....	8-11
Pressure .....	8-3
Replacement .....	8-10
Rotation .....	8-9
Sidewall labeling .....	8-4
Snow tires .....	8-8
Spare tire .....	3-5
Summer tires .....	8-8
Terminology and definitions .....	8-6
Traction .....	8-10

## Towing

A trailer (or vehicle) .....	2-19
Emergency .....	3-13
If your vehicle must be towed .....	3-11

## Transaxle

Automatic .....	2-8
Automatic transaxle fluid checking .....	6-18
Manual .....	2-5
Manual transaxle oil checking .....	6-17

Trip Computer .....	1-58
---------------------	------

Trip Odometer .....	1-57
---------------------	------

Trunk Lid .....	1-85
-----------------	------

**V**

Vehicle Identification Number (VIN) .....	8-2
---	-----

Vehicle Load Limit .....	2-22
--------------------------	------

Vehicle Specifications .....	9-1
------------------------------	-----

**W**

Warning and Indicator Lights .....	1-52
------------------------------------	------

Warranties for Your Hyundai Vehicle .....	8-12
---	------

## Windows

Power .....	1-11
-------------	------

Windshield Wiper and Washer .....	1-64
-----------------------------------	------

Intermittent wiper operation .....	1-65
------------------------------------	------

Mist wiper operation .....	1-65
----------------------------	------

Windshield washer operation .....	1-64
-----------------------------------	------

Windshield Wiper Blades .....	6-15
-------------------------------	------

This Owner's Manual should be considered a part of the car and remain with it when it is sold for the use of the next owner.

OWNER'S I.D.

ORIGINAL OWNER \_\_\_\_\_

ADDRESS \_\_\_\_\_

CITY \_\_\_\_\_ STATE \_\_\_\_\_ ZIP CODE \_\_\_\_\_

DELIVERY DATE

(Date Sold to Original Retail Purchaser)

DEALER NAME \_\_\_\_\_ DEALER NO. \_\_\_\_\_

ADDRESS \_\_\_\_\_

CITY \_\_\_\_\_ STATE \_\_\_\_\_ ZIP CODE \_\_\_\_\_

**SERVICE STATION INFORMATION****FUEL:**

UNLEADED gasoline only  
Pump Octane Rating of 87 (Research Octane Number 91) or higher.

**FUEL TANK CAPACITY**

US.gal (Imp.gal., liter) 17.7 (14.7, 67)

**TIRE PRESSURE:**

See the label on the driver's side of the center pillar outer panel.

**OTHER TIRE INFORMATION:**

See pages 8-2 through 8-13.

**HOOD RELEASE:**

Pull handle under left side of dash.

**ENGINE OIL:**

API grade SJ, SL or ABOVE/ILSAC grade GF-3 or ABOVE and fuel efficient oil. Use SAE 5W-20, 5W-30 or 10W-30 if normal temperatures are above 0°F (-18°C). See page 6-5 or 9-4.

**MANUAL TRANSAXLE:**

HYUNDAI GENUINE PARTS MTF 75W/85 (API GL-4) Oil level should be up to filler-bolt hole in housing beside differential.

**AUTOMATIC TRANSAXLE:**

Your Hyundai automatic transaxle is specially designed to operate with HYUNDAI GENUINE ATF SP III, DIAMOND ATF SP III, SK ATF SP III or other brands meeting the SP III specification approved by Hyundai Motor Co.. Damage caused by a nonspecified fluid is not covered by your new vehicle limited warranty.

**QUICK INDEX**

o Car will not start .....	3-2
o Flat tire .....	3-6
o Warning light/chime comes on .....	1-52 ~ 1-55
o Engine overheats .....	3-4
o Towing of your vehicle .....	3-11
o Starting the engine .....	2-4
o Driving tips for first 1,200 miles (2,000 km) .....	1-3
o Scheduled maintenance .....	5-4
o Reporting safety defects .....	8-14